

PRODUCT NO.
10018784-X0XXXX

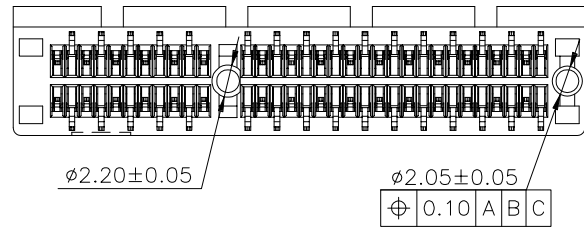

SECTION P-P

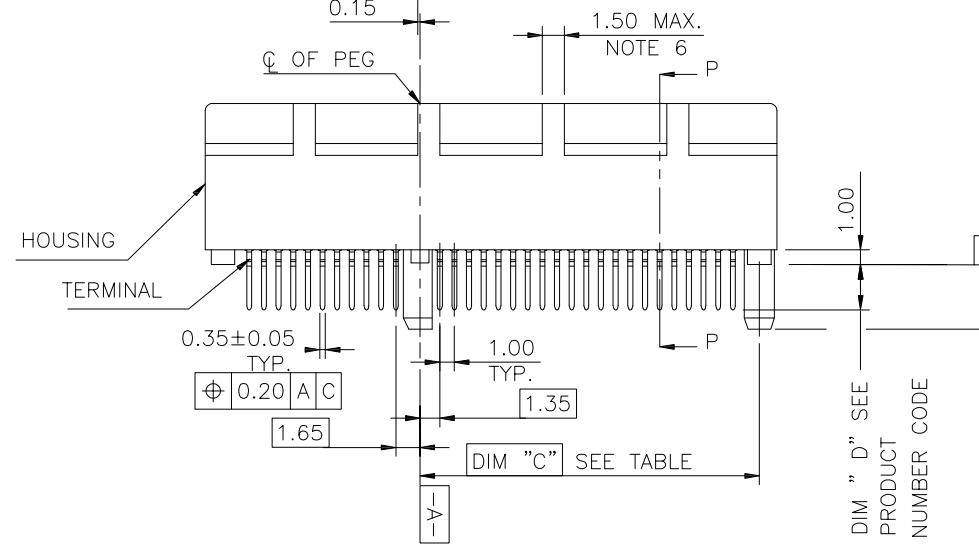

PLASTIC PEG TYPE

CONFIDENTIAL

mat'l. code				tolerances unless otherwise specified			CUSTOMER COPY	FCI www.fciconnect.com		
ltr	ecn no	dr	date	linear	.X ± 0.30	projection		title		
M	T05-0124	M W	06/07/05		.XX ± 0.20		PCI EXPRESS GEN3			
N	T05-0153	M W	07/12/05		.XXX ± 0.10		CARD EDGE ASSY			
P	T05-0208	M W	09/15/05	angles	0° ±2°		product family		code	
R	T06-0206	R C	12/01/06	dr	STONE LI 05/27/15		EDGE CARD		TWN	
S	ELX-DG-2161-1	S T	05/27/15	enr	STONE LI 05/27/15	MM	size	dwg no	sheet	
				chr	/	scale	A4	10018784	1 of 6	
				appd	PM ZHENG 05/27/15	2:1				
sheet index	revision	S	S	S	S	S				
	sheet	1	2	3	4	5				

cage code
22526

PRODUCT NO.
10018784-X1XXXX



METAL BOARD LOCKS TYPE

CONFIDENTIAL

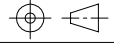
mat'l. code				tolerances unless otherwise specified		CUSTOMER COPY		 www.fciconnect.com	
ltr	ecn no	dr	date	linear	.X ± 0.30	projection	title		
				angles	.XX ± 0.20	 MM	PCI EXPRESS GEN3		
				dr	.XXX ± 0.10		product family	EDGE CARD	code
				enr	0° ±2°	size	dwg no	TWN	
				chr		scale		sheet	
				appd		2:1	A4	2 of	
sheet index	revision sheet								

cage code
22526

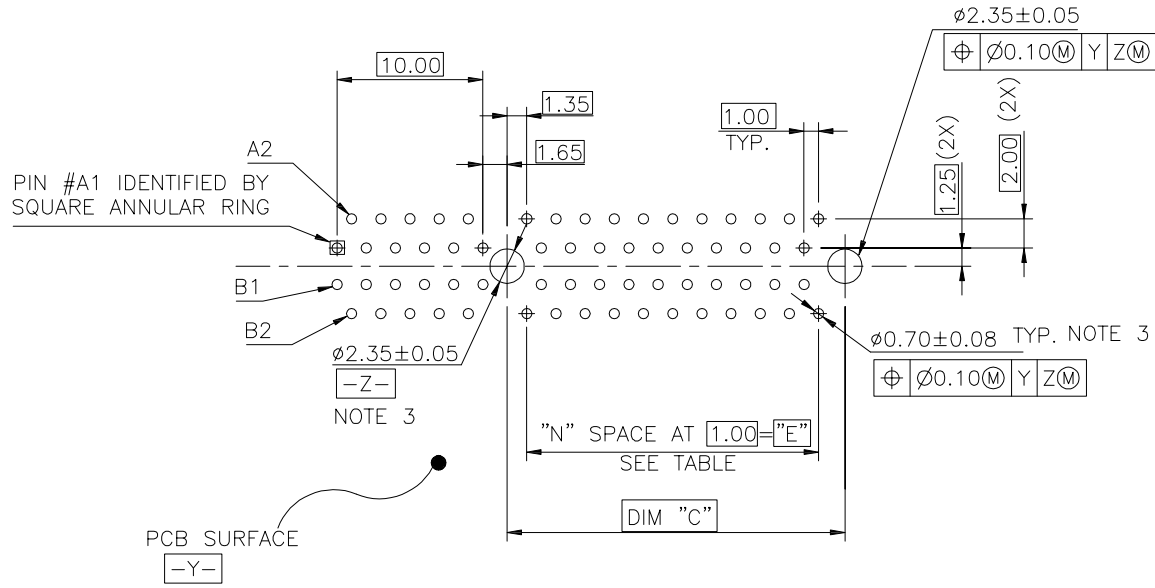

← I/O PANEL DIRECTION

RECOMMENDED FOOTPRINT

CONFIDENTIAL

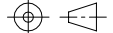
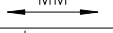
mat'l. code				tolerances unless otherwise specified			CUSTOMER COPY		 www.fciconnect.com			
ltr	ecn no	dr	date	linear	.X ±		projection	title				
					.XX ±			PCI EXPRESS GEN3				
					.XXX ±			CARD EDGE ASS'Y				
				angles	0° ±2°				product family		code	
				dr	STONE LI	05/27/15	MM		EDGE CARD		TWN	
				enr	STONE LI	05/27/15			size dwg no		sheet	
				chr	/	/	scale		A4 10018784		3 of	
				appd	PM ZHENG	05/27/15	2:1					
sheet index		revision sheet										

cage code
22526



SCALE 2:1



ADD-IN CARD EDGE-FINGER DIMENSIONS

#	POS	REF.	N	DIM "G"	"F"
36	6		6	8.15	B17
64	20		20	22.15	B31
98	37		37	39.15	B48
164	70		70	72.15	B81

PIN "F" SEE TABLE 2.40±0.10

CONFIDENTIAL

mat'l. code				tolerances unless otherwise specified		CUSTOMER COPY	 www.fciconnect.com	
ltr	ecn no	dr	date	linear	.X ±		projection	title
					.XX ±			
				angles	.XXX ±		product family EDGE CARD	code TWN
				dr	0° ±2°	size A4		
				enr			scale 2:1	10018784
				chr		cage code 22526		
				appd				
sheet index	revision							
	sheet							

NOTES:

1.MATERIAL:

HOUSING: NYLON, GLASS FILLED UL94V-0 RATE, SUITABLE FOR WAVE SOLDERING.

TERMINAL: COPPER ALLOY

PLATING: 50u" NICKEL UNDERPLATE ALL OVER CONTACT AREA PLATING - SEE PRODUCT NUMBER CODE SOLDER TAIL: TIN/LEAD (90/10) - SEE PRODUCT NUMBER CODE 100u" MIN. OVER 50u" NICKEL

METAL BOARD LOCKS: COPPER ALLOY FINISH: 100u" TIN/LEAD (90/10) OVER 50u" NICKEL UNDERPLATE SEE PRODUCT NUMBER CODE

2.PRODUCT SPECIFICATION: GS-12-233

③THE HORIZONTAL AXIS FOR THE HOLE PATTERN IS ESTABLISHED BY A LINE THROUGH THE CENTER OF THE TWO Ø2.35 HOLES. THE VERTICAL AXIS IS 90° TO THE HORIZONTAL AXIS, THROUGH THE CENTER OF DATUM Z.

④NO TIE BAR PERMITTED FROM CARD EDGE TO LEADING EDGE OF PAD FOR PINS A1 AND PIN NUMBERS "F".

⑤CHAMFER EDGES MUST BE FREE OF CUTTING BURRS.

⑥FREQUENCY & LOCATION AT SUPPLIER DISCRETION. RIDGE MAY BE CONTINUOUS WITH NO BREAKS.

7.RoHS COMPATIBLE PRODUCT SPECIFICATIONS

a - PLATING:

- "LF" MEANS THE PRODUCT IS LEAD-FREE, 2um MINIMUM MATTE TIN OVER 1.27um MINIMUM NICKEL UNDERPLATE.

b - MANUFACTURING PROCESS COMPATIBILITY

- THE HOUSING WILL WITHSTAND EXPOSURE TO 260°C±5°C SOLDER BATH TEMPERATURE FOR 5 SECONDS IN A WAVE SOLDER APPLICATION WITH A 1.6mm MIN THICK CIRCUIT BOARD. - THE HOUSING WILL WITHSTAND EXPOSURE TO 240°C±5°C SOLDER BATH TEMPERATURE FOR 5 SECONDS IN A WAVE SOLDER APPLICATION WITH A 1.6mm MIN THICK CIRCUIT BOARD.(For 10018784-X 0 X X X X(X X) options)

CONNECTOR	# POS REF.	N	DIM "A"	DIM "B"	DIM "C"	"E"
1 PORT	36	6	7.65	25.00	9.15	6.00
4 PORT	64	20	21.65	39.00	23.15	20.00
8 PORT	98	37	38.65	56.00	40.15	37.00
16 PORT	164	70	71.65	89.00	73.15	70.00

PRODUCT NUMBER CODE
10018784-X X X X X X □ □

HOUSING COLOR OPTIONS

- 0-WHITE
- 1-BLACK

PEGS OPTIONS

- 0-PLASTIC PEGS
- 1-METAL BOARD LOCKS

TERMINAL PLATING OPTIONS

- 0-50u" Ni UNDERPLATE 30u" Au CONTACT AREA 100u" TIN TAIL AREA ----- COMPATIBLE RoHS
- 1-50u" Ni UNDERPLATE 15u" Au CONTACT AREA 100u" TIN TAIL AREA ----- COMPATIBLE RoHS
- 2-50u" Ni UNDERPLATE GOLD FLASH CONTACT AREA 100u" TIN TAIL AREA ----- COMPATIBLE RoHS
- 3-50u" Ni UNDERPLATE 30u" Au CONTACT AREA 100u" TIN/LEAD TAIL AREA ----- INCOMPLIANT RoHS
- 4-50u" Ni UNDERPLATE 15u" Au CONTACT AREA 100u" TIN/LEAD TAIL AREA ----- INCOMPLIANT RoHS
- 5-50u" Ni UNDERPLATE GOLD FLASH CONTACT AREA 100u" TIN/LEAD TAIL AREA ----- INCOMPLIANT RoHS

LEAD FREE OPTION

LEAVE BLANK FOR TERMINAL PLATING 3,4,5 "LF" FOR TERMINAL PLATING OPTION 0,1,2

POS OPTIONS

- 0-36
- 1-64
- 2-98
- 3-164

PACKAGING OPTIONS

T-TRAY PACKAGING M-TRAY PACKAGING & MYLAR TAPE FOR PICK-N-PLACE. SEE FIGURE 1

TAIL LENGTH OPTIONS

	DIM "D"	PCB THICKNESS	BOARD LOCKS DIM"G"
0	2.30 ^{+0.25} / _{-0.13}	1.56±0.10	1.70±0.15
1	3.10 ^{+0.25} / _{-0.13}	2.36±0.10	2.50±0.15

CONFIDENTIAL



www.fciconnect.com

CUSTOMER COPY

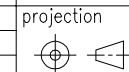

projection

scale 1:1

title PCI EXPRESS GEN3 CARD EDGE ASS'Y

product family EDGE CARD code TWN

size dwg no 10018784 sheet 5 of

mat'l. code				tolerances unless otherwise specified			CUSTOMER COPY	
ltr	ecn no	dr	date	linear	.X ±	.XX ±	.XXX ±	projection
				angles	0° ±2°			
				dr	STONE LI	05/27/15		MM
				enr	STONE LI	05/27/15		
				chr	/	/		
				appd	PM ZHENG	05/27/15		
sheet index	revision sheet							

cage code 22526



FIGURE 1

CONFIDENTIAL

mat'l. code				tolerances unless otherwise specified			CUSTOMER COPY	 www.fciconnect.com		
ltr	ecn no	dr	date	linear	.X ± 0.25	projection				
					.XX ± 0.13	 MM	title		PCI EXPRESS GEN3 CARD EDGE ASS'Y	
				angles	.XXX ± 0.05		product family	EDGE CARD		code
				dr	STONE LI 05/27/15	scale	size	dwg no	TWN	
				enr	STONE LI 05/27/15		1.5:1	A4		10018784
				chr	/ /					sheet
				appd	PM ZHENG 05/27/15			6 of		
sheet index		revision sheet								

cage code 22526



Компания «ЭлектроПласт» предлагает заключение долгосрочных отношений при поставках импортных электронных компонентов на взаимовыгодных условиях!

Наши преимущества:

- Оперативные поставки широкого спектра электронных компонентов отечественного и импортного производства напрямую от производителей и с крупнейших мировых складов;
- Поставка более 17-ти миллионов наименований электронных компонентов;
- Поставка сложных, дефицитных, либо снятых с производства позиций;
- Оперативные сроки поставки под заказ (от 5 рабочих дней);
- Экспресс доставка в любую точку России;
- Техническая поддержка проекта, помощь в подборе аналогов, поставка прототипов;
- Система менеджмента качества сертифицирована по Международному стандарту ISO 9001;
- Лицензия ФСБ на осуществление работ с использованием сведений, составляющих государственную тайну;
- Поставка специализированных компонентов (Xilinx, Altera, Analog Devices, Intersil, Interpoint, Microsemi, Aeroflex, Peregrine, Syfer, Eurofarad, Texas Instrument, Miteq, Cobham, E2V, MA-COM, Hittite, Mini-Circuits, General Dynamics и др.);

Помимо этого, одним из направлений компании «ЭлектроПласт» является направление «Источники питания». Мы предлагаем Вам помощь Конструкторского отдела:

- Подбор оптимального решения, техническое обоснование при выборе компонента;
- Подбор аналогов;
- Консультации по применению компонента;
- Поставка образцов и прототипов;
- Техническая поддержка проекта;
- Защита от снятия компонента с производства.



Как с нами связаться

Телефон: 8 (812) 309 58 32 (многоканальный)

Факс: 8 (812) 320-02-42

Электронная почта: org@eplast1.ru

Адрес: 198099, г. Санкт-Петербург, ул. Калинина, дом 2, корпус 4, литера А.