

Product Description

Qorvo's TGA2594 is a Ka-band power amplifier fabricated on Qorvo's 0.15 um GaN on SiC process. Operating from 27 to 31 GHz, it achieves 5W saturated output power with an efficiency of 28 % PAE, and 23 dB small signal gain. Along with excellent linear characteristics, the TGA2594 is ideally suited to support both commercial and defense related satellite communications.

To simplify system integration, the TGA2594 is fully matched to 50 ohms with integrated DC blocking caps on both I/O ports.

The TGA2594 is 100% DC and RF tested on-wafer to ensure compliance to electrical specifications.

Lead-free and RoHS compliant.

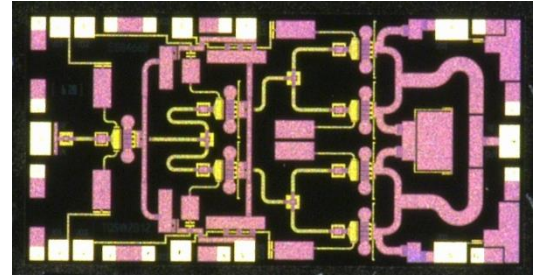

Product Features

- Frequency Range: 27 to 31 GHz
- P_{OUT} : 36.5 dBm ($P_{IN} = 18$ dBm), CW
- PAE: 28 % ($P_{IN} = 18$ dBm), CW
- Small Signal Gain: 23 dB
- Return Loss: 10 dB
- IM3 @ 25 dBm/tone: -35 dBc
- IM5 @ 25 dBm/tone: -45 dBc
- Bias: $V_D = +20$ V, $I_{DQ} = 140$ mA, $V_G \approx -2.5$ V Typical
- Chip Dimensions: 3.24 x 1.74 x 0.10 mm

Performance is typical across frequency. Please reference electrical specification table and data plots for more details.

Functional Block Diagram

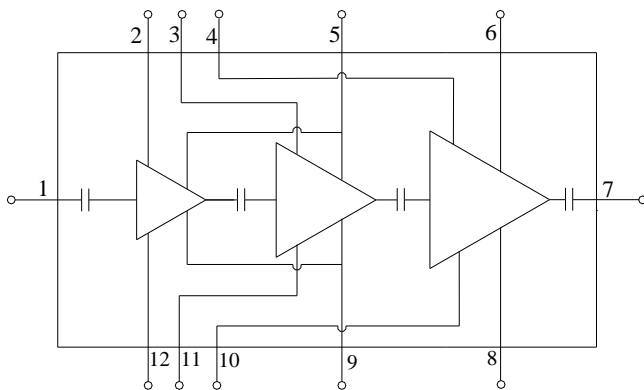

Applications

- Satellite Communications

Ordering Information

Part No.	Description
TGA2594	27 – 31GHz 5W GaN Power Amplifier
TGA2594S2	Samples (2 pcs. pack)
TGA2594EVB	Evaluation Board for TGA2594

Absolute Maximum Ratings

Parameter	Value / Range
Drain Voltage (V_D)	29.5
Gate Voltage Range (V_G)	-5 to 0 V
Drain Current (I_D)	1.4 A
Gate Current (I_G)	See chart
Power Dissipation (P_{DISS}), CW, 85°C	22 W
Input Power (P_{IN}), CW, 50 Ω , $V_D=22$ V, $I_{DQ}=280$ mA, 85 °C	30 dBm
Input Power (P_{IN}), CW, 10:1 VSWR, $V_D=22$ V, $I_{DQ}=280$ mA, 25 °C	25 dBm
Channel Temperature (T_{CH})	275 °C
Mounting Temperature (30 seconds)	320 °C
Storage Temperature	-40 to 150 °C

Operation of this device outside the parameter ranges given above may cause permanent damage. These are stress ratings only, and functional operation of the device at these conditions is not implied.

Recommended Operating Conditions

Parameter	Min	Typ	Max	Units
Drain Voltage (V_D)		+20		V
Drain Current, Quiescent (I_{DQ})		140		mA
Drain Current, RF (I_{D_Drive})	See charts page 6			mA
Gate Voltage Typ. Range (V_G)	-2 to -3			V
Operating Temp. Range	-40	+25	+85	°C

Electrical specifications are measured at specified test conditions. Specifications are not guaranteed over all recommended operating conditions.

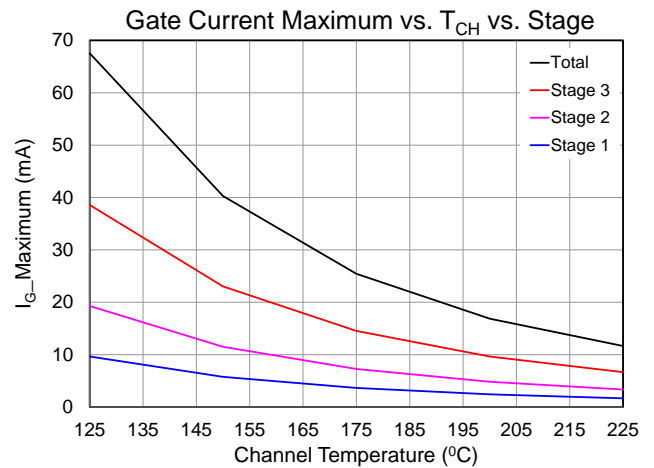

Electrical Specifications

Parameter	Conditions ⁽¹⁾ ⁽²⁾	Min	Typ	Max	Units
Operational Frequency Range		27		31	GHz
Output Power at Saturation, P_{SAT}	$P_{IN} = +18$ dBm	34.6	36.5		dBm
Power Added Efficiency, PAE	$P_{IN} = +18$ dBm		28		%
Small Signal Gain, S_{21}			23		dB
Input Return Loss, IRL			10		dB
Output Return Loss, ORL			8		dB
3 RD Intermodulation Products, IM3	$P_{OUT/TONE} = +25$ dBm, Tone Spacing = 1 MHz		-35		dBc
5 th Intermodulation Products, IM5	$P_{OUT/TONE} = +25$ dBm, Tone Spacing = 1 MHz		-45		dBc
P_{SAT} Temperature Coefficient	$T_{DIFF} = +25^{\circ}C$ to $+85^{\circ}C$; $P_{IN} = +22$ dBm		-0.01		dBm/°C
S_{21} Temperature Coefficient	$T_{DIFF} = -40^{\circ}C$ to $+85^{\circ}C$		-0.09		dB/°C

Notes:

1. Test conditions unless otherwise noted: CW, $V_D = +20$ V, $I_{DQ} = 140$ mA, $V_G = -2.5$ V +/- 0.5 V typical, $T_{BASE} = +25$ °C, $Z_0 = 50$ Ω
2. T_{BASE} is back side of carrier plate

Thermal and Reliability Information

Parameter	Test Conditions	Value	Units
Thermal Resistance (θ_{JC})	For $I_{DQ} = 140$ mA: $T_{BASE} = 85$ °C, $V_D = +20$ V, $I_{D_Drive} = 870$ mA,	5.64	°C/W
Channel Temperature (T_{CH}) under RF Drive	Frequency = 28 GHz, $P_{IN} = 18$ dBm, $P_{OUT} = 36.2$ dBm, $P_{DISS} = 13.3$ W	160	°C

Notes:

1. Thermal resistance measured to back of carrier plate. MMIC mounted on 20 mils CuMo carrier using 1.5 mil 80/20 AuSn.
2. Channel temperature indicated is an IR scan equivalent temperature. Thermal resistance is calculated using this value. Additional information can be found in the Qorvo Applications Note "GaN Device TCHMAX Theta-JC and Reliability Estimates," located here <https://www.qorvo.com/products/d/da006480>

Typical Performance – Small Signal

Test conditions unless otherwise noted: CW, $V_D = +20\text{ V}$, $I_{DQ} = 140\text{ mA}$ and 280 mA , $T_{BASE} = +25\text{ }^\circ\text{C}$

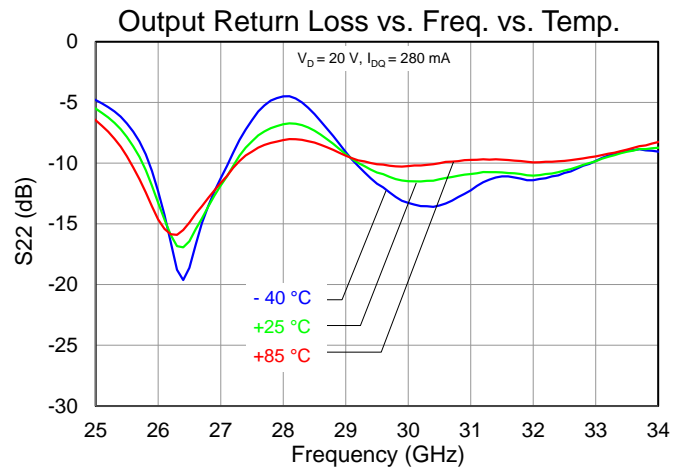
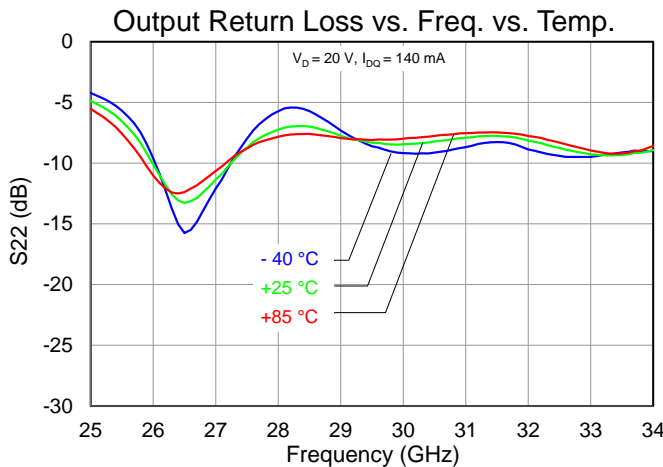
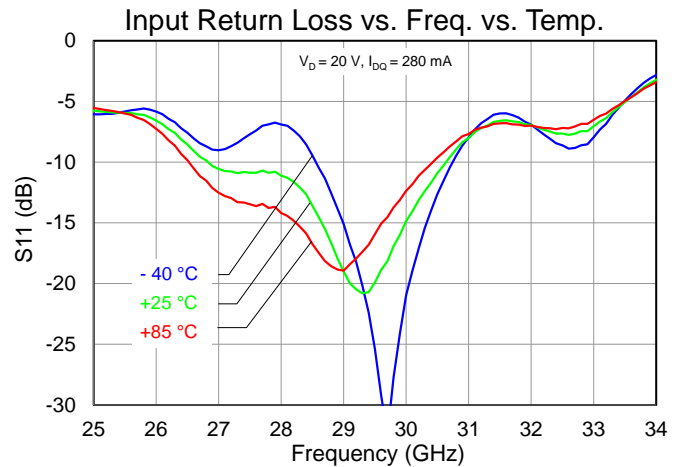
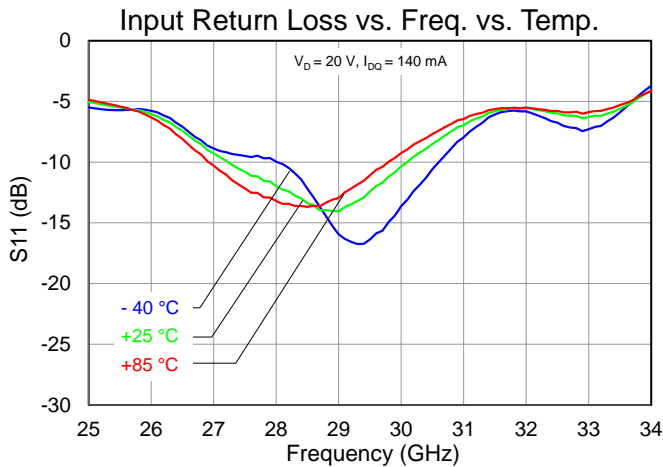
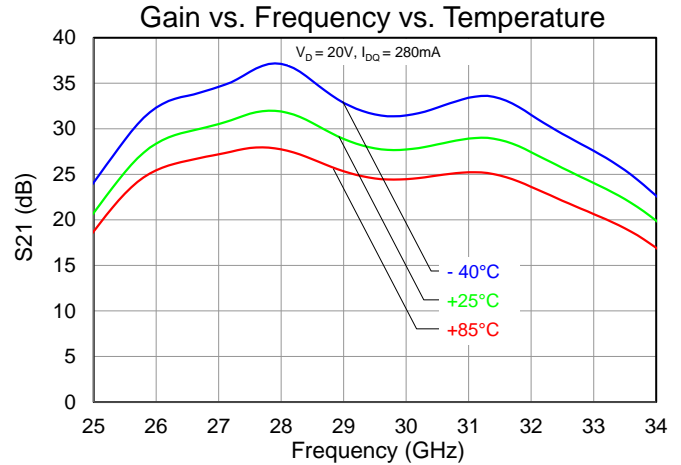
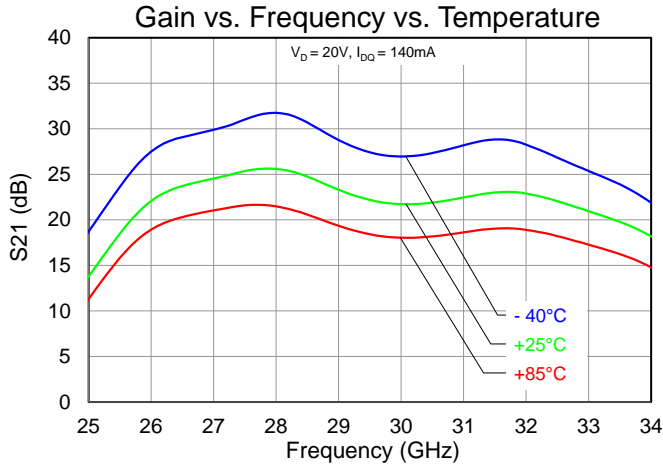

Typical Performance – Large Signal

Test conditions unless otherwise noted: CW, $V_D = +20\text{ V}$, $I_{DQ} = 140\text{ mA}$, $T_{BASE} = +25\text{ }^\circ\text{C}$

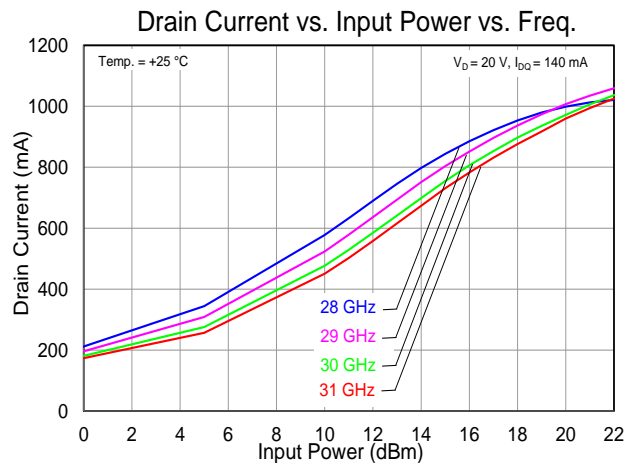
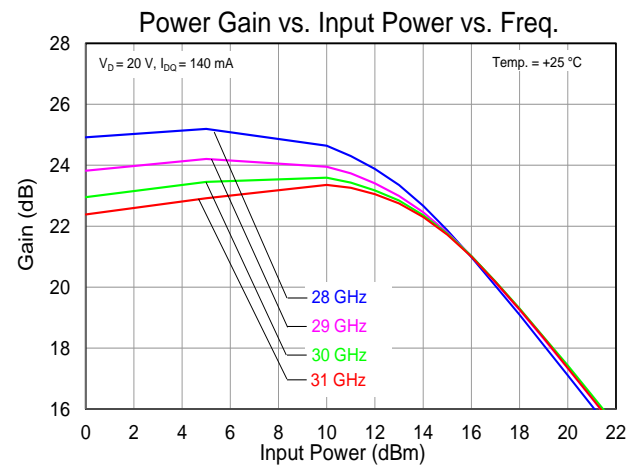
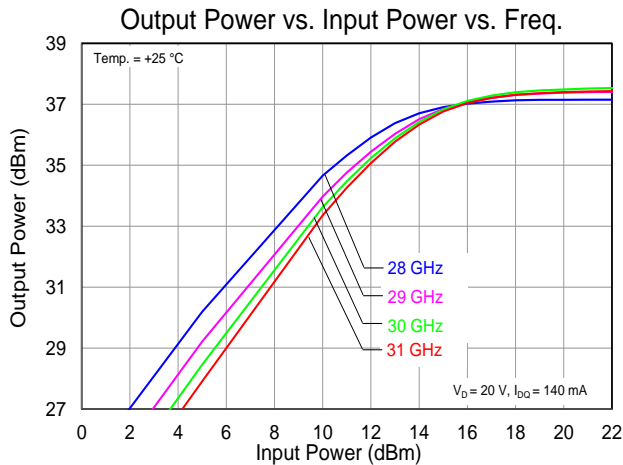
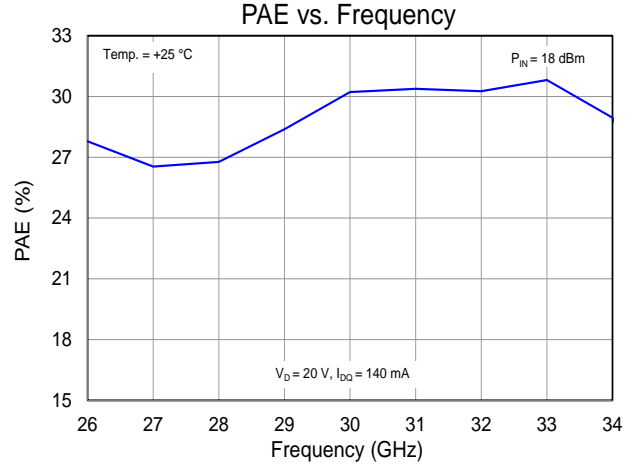
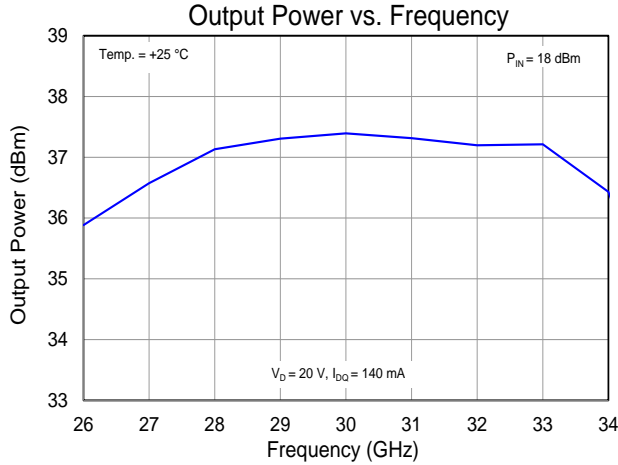

Typical Performance – Linearity

Test conditions unless otherwise noted: CW, $V_D = +20$ V, $I_{DQ} = 140$ mA, Tone Spacing = 1 MHz, $T_{BASE} = +25$ °C

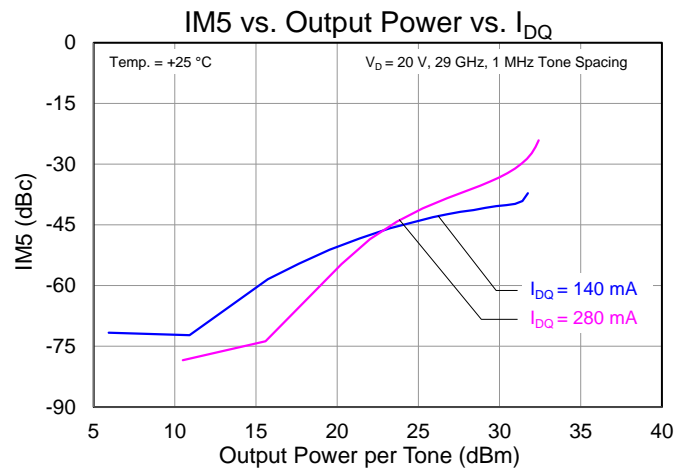
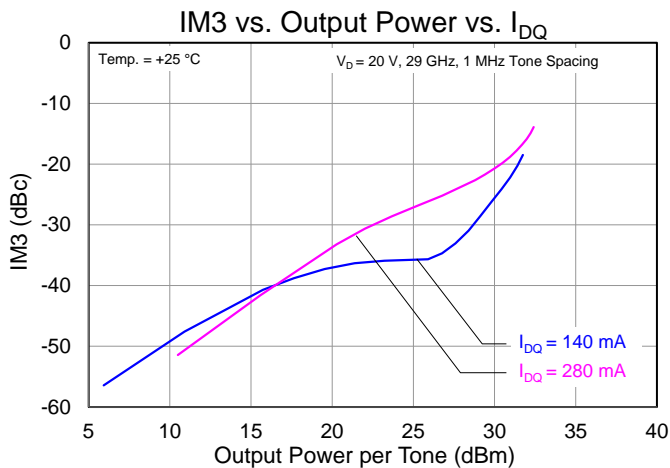
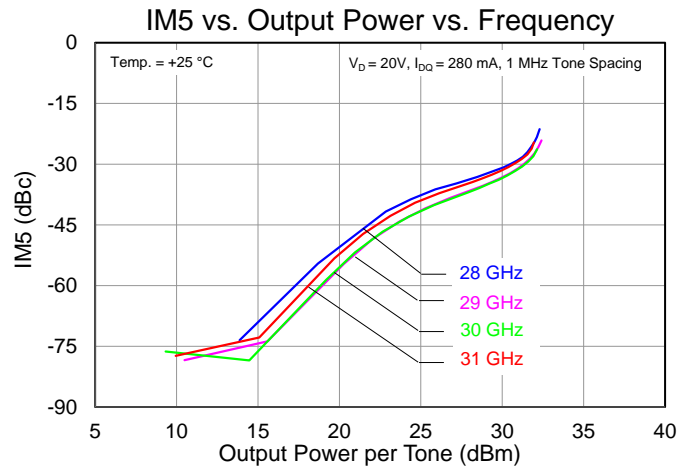
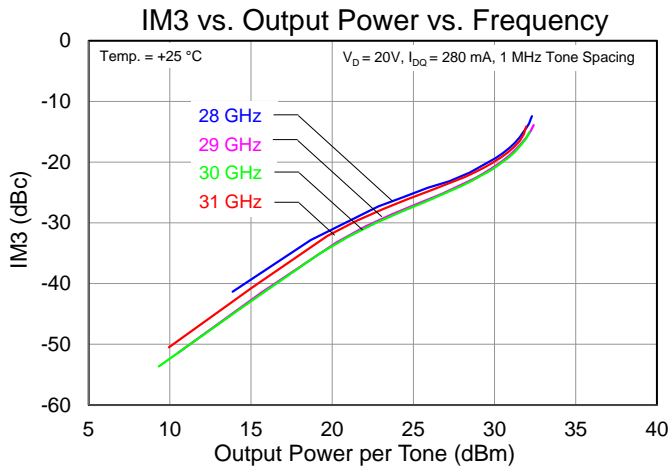
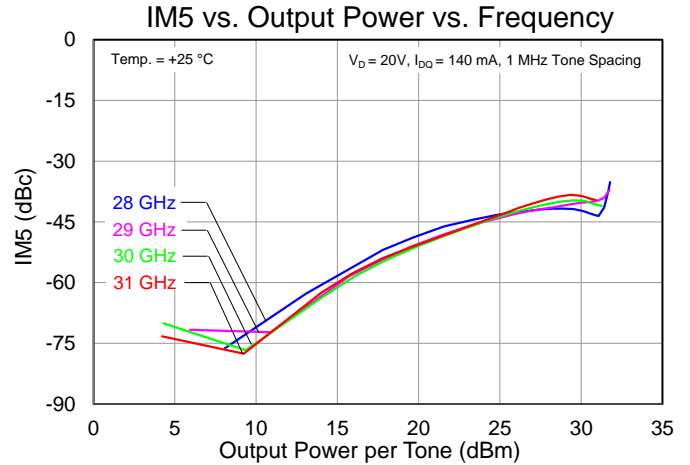
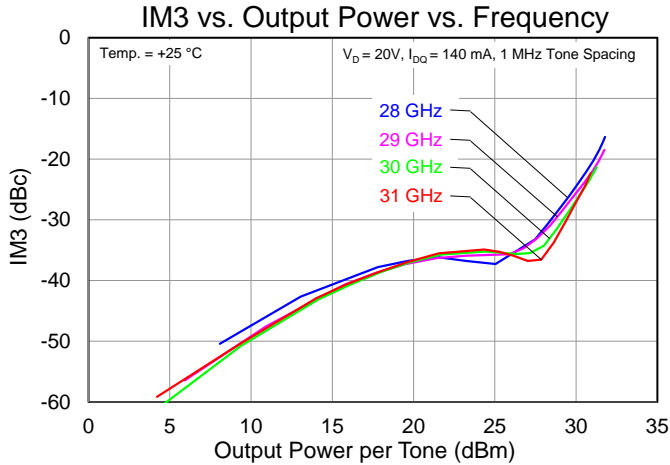

Typical Performance – Linearity (cont.)

Test conditions unless otherwise noted: CW, $V_D = +20\text{ V}$, $I_{DQ} = 140\text{ mA}$, Tone Spacing = 1 MHz, $T_{BASE} = +25\text{ }^\circ\text{C}$

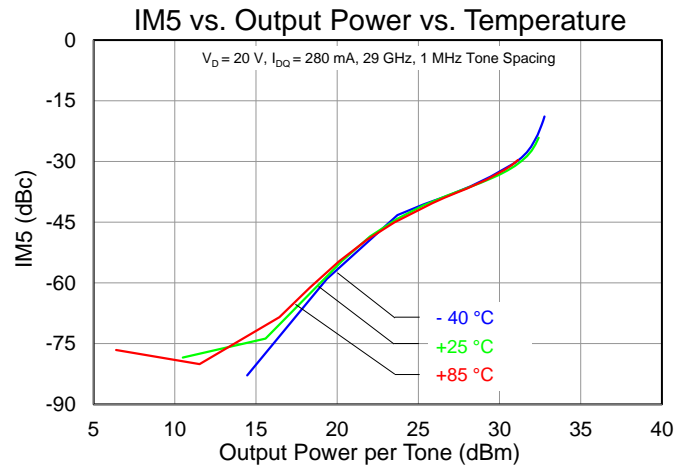
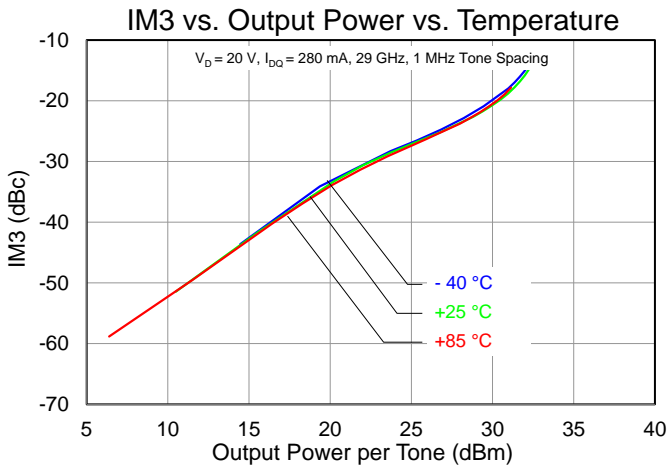
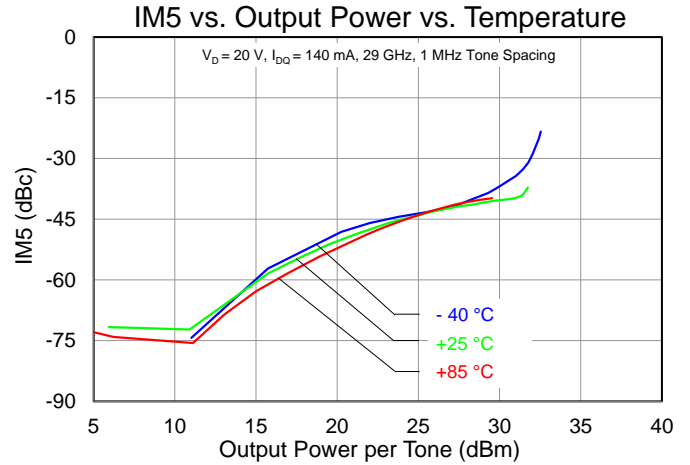
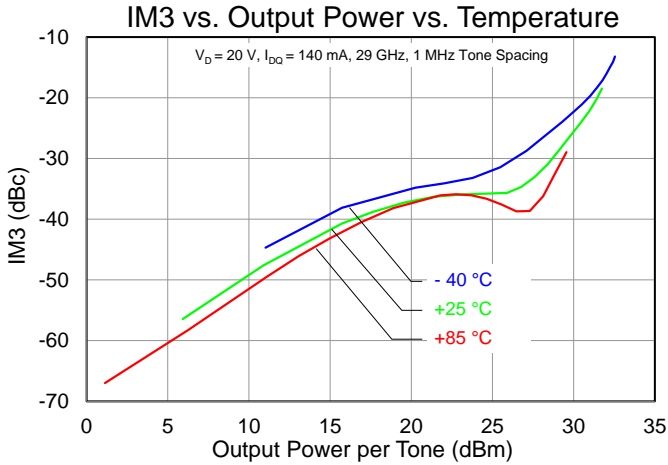

Application Circuit

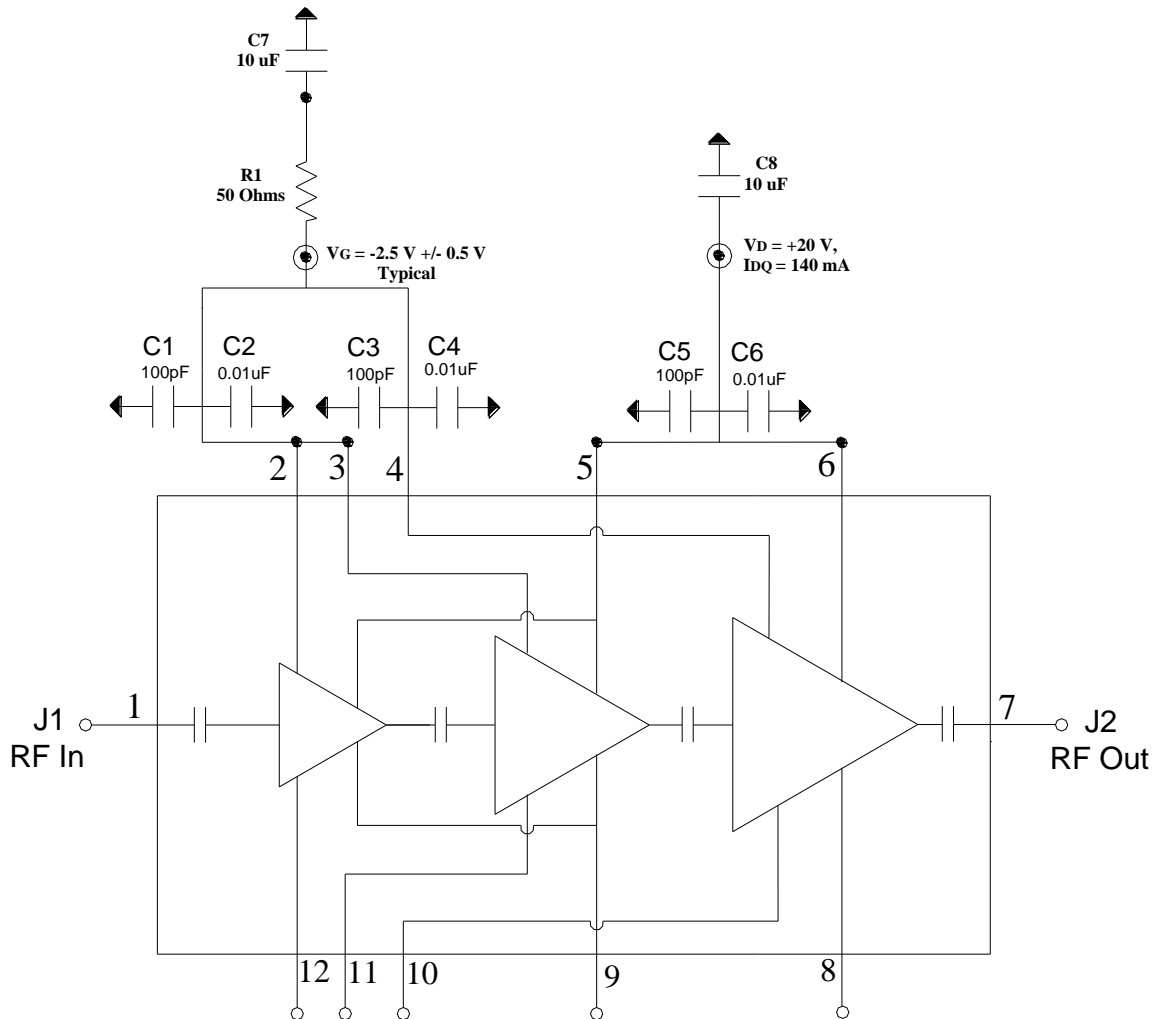

Bias Up Procedure

1. Set I_D limit to 1.2 A, I_G limit to 10 mA
2. Apply -5 V to V_G (Combine all V_G 's together)
3. Apply $+20\text{ V}$ to V_D (Combine all V_D 's together)
4. Adjust V_G until $I_{DQ} = 140\text{ mA}$ ($V_G \sim -2.5\text{ V} \pm \text{Typ.}$)
5. Apply RF supply

Bias Down Procedure

1. Turn off RF signal
2. Reduce V_G to -5 V ; ensure I_{DQ} is approx. 0 mA
3. Set V_D to 0 V
4. Turn off V_D supply
5. Turn off V_G supply

Assembly Drawing

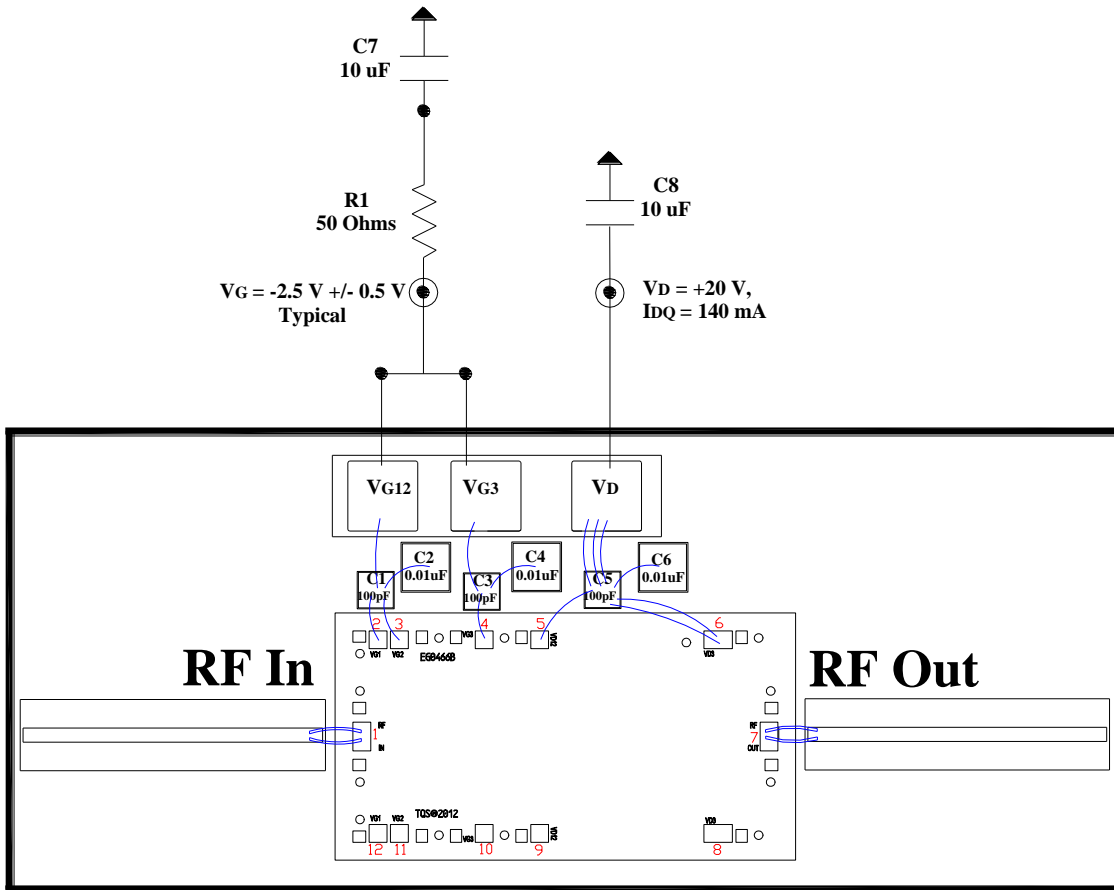

Notes: Minimize RF wirebond lengths to achieve optimum return loss. Options in order of preference are:

1. Short w = 5mil ribbon bonds
2. Multiple short wedge or chisel bonds
3. Multiple ball bonds

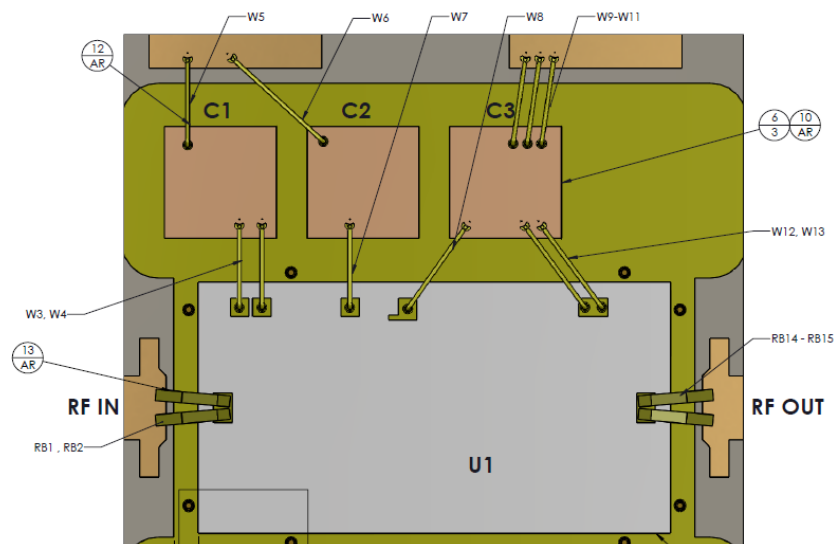

Mechanical Drawing

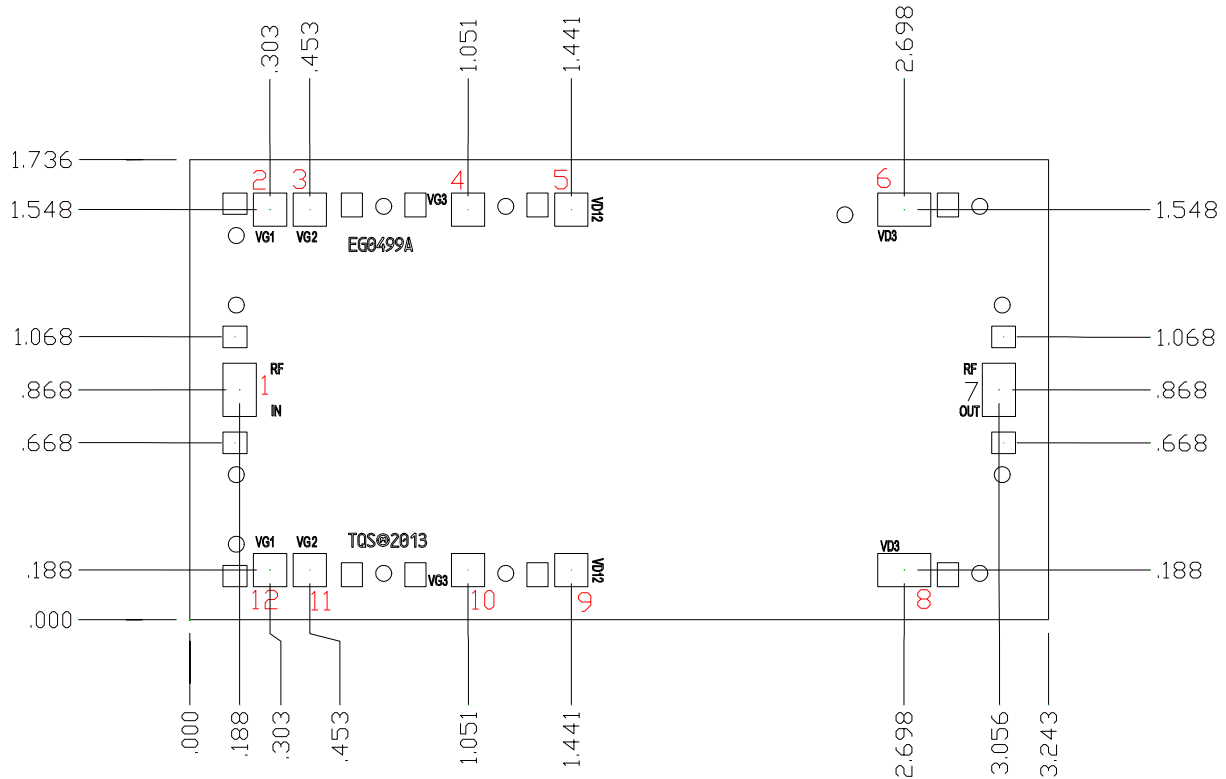

Unit: millimeters
 Thickness: 0.10
 Die x, y size tolerance: +/- 0.050
 Chip edge to bond pad dimensions are shown to center of pad
 Ground is backside of die

Bond Pad Description

Pad No.	Symbol	Pad Size	Description
1	RF In	0.125 x 0.200	Input; matched to 50 Ω; DC blocked.
2, 12	V _{G1}	0.125 x 0.125	Gate voltage, V _{G1} top and bottom. Bias network is required; see Application Circuit on page 8 as an example.
3, 11	V _{G2}	0.125 x 0.125	Gate voltage, V _{G2} top and bottom. Bias network is required; see Application Circuit on page 8 as an example.
4, 10	V _{G3}	0.125 x 0.125	Gate voltage, V _{G1} top and bottom. Bias network is required; see Application Circuit on page 8 as an example.
5, 9	V _{D12}	0.125 x 0.125	Drain voltage, V _{D12} top and bottom. Bias network is required; see Application Circuit on page 8 as an example.
6, 8	V _{D3}	0.200 x 0.125	Drain voltage, V _{D3} top and bottom. Bias network is required; see Application Circuit on page 8 as an example.
7	RF Out	0.125 x 0.200	Output; matched to 50 Ω; DC blocked.

Assembly Notes

Component placement and adhesive attachment assembly notes:

- Vacuum pencils and/or vacuum collets are the preferred method of pick up.
- Air bridges must be avoided during placement.
- The force impact is critical during auto placement.

Reflow process assembly notes:

- Use AuSn (80/20) solder and limit exposure to temperatures above 300 °C to 3–4 minutes, maximum.
- An alloy station or conveyor furnace with reducing atmosphere should be used.
- Do not use any kind of flux.
- Coefficient of thermal expansion matching is critical for long-term reliability.
- Devices must be stored in a dry nitrogen atmosphere.

Interconnect process assembly notes:

- Thermosonic ball bonding is the preferred interconnect technique.
- Force, time, and ultrasonic are critical parameters.
- Aluminum wire should not be used.
- Devices with small pad sizes should be bonded with 0.0007-inch wire.

Handling Precautions

Parameter	Rating	Standard
ESD – Human Body Model (HBM)	1A	ANSI/ESD/JEDEC JS-001
ESD – Charged Device Model (CDM)	C3	ANSI/ESD/JEDEC JS-002



Caution!
ESD-Sensitive Device

Solderability

Use only AuSn (80/20) solder, and limit exposure to temperatures above 300 °C to 3–4 minutes, maximum.

RoHS Compliance

This product is compliant with the 2011/65/EU RoHS directive (Restrictions on the Use of Certain Hazardous Substances in Electrical and Electronic Equipment), as amended by Directive 2015/863/EU.

This product also has the following attributes:

- Lead Free
- Halogen Free (Chlorine, Bromine)
- Antimony Free
- TBBP-A (C₁₅H₁₂Br₄O₂) Free
- PFOS Free
- SVHC Free

Contact Information

For the latest specifications, additional product information, worldwide sales and distribution locations:

Web: www.qorvo.com

Tel: 1-844-890-8163

Email: customer.support@qorvo.com

Important Notice

The information contained herein is believed to be reliable; however, Qorvo makes no warranties regarding the information contained herein and assumes no responsibility or liability whatsoever for the use of the information contained herein. All information contained herein is subject to change without notice. Customers should obtain and verify the latest relevant information before placing orders for Qorvo products. The information contained herein or any use of such information does not grant, explicitly or implicitly, to any party any patent rights, licenses, or any other intellectual property rights, whether with regard to such information itself or anything described by such information. **THIS INFORMATION DOES NOT CONSTITUTE A WARRANTY WITH RESPECT TO THE PRODUCTS DESCRIBED HEREIN, AND QORVO HEREBY DISCLAIMS ANY AND ALL WARRANTIES WITH RESPECT TO SUCH PRODUCTS WHETHER EXPRESS OR IMPLIED BY LAW, COURSE OF DEALING, COURSE OF PERFORMANCE, USAGE OF TRADE OR OTHERWISE, INCLUDING THE IMPLIED WARRANTIES OF MERCHANTABILITY AND FITNESS FOR A PARTICULAR PURPOSE.**

Without limiting the generality of the foregoing, Qorvo products are not warranted or authorized for use as critical components in medical, life-saving, or life-sustaining applications, or other applications where a failure would reasonably be expected to cause severe personal injury or death.

Copyright 2018 © Qorvo, Inc. | Qorvo is a registered trademark of Qorvo, Inc.



Компания «ЭлектроПласт» предлагает заключение долгосрочных отношений при поставках импортных электронных компонентов на взаимовыгодных условиях!

Наши преимущества:

- Оперативные поставки широкого спектра электронных компонентов отечественного и импортного производства напрямую от производителей и с крупнейших мировых складов;
- Поставка более 17-ти миллионов наименований электронных компонентов;
- Поставка сложных, дефицитных, либо снятых с производства позиций;
- Оперативные сроки поставки под заказ (от 5 рабочих дней);
- Экспресс доставка в любую точку России;
- Техническая поддержка проекта, помощь в подборе аналогов, поставка прототипов;
- Система менеджмента качества сертифицирована по Международному стандарту ISO 9001;
- Лицензия ФСБ на осуществление работ с использованием сведений, составляющих государственную тайну;
- Поставка специализированных компонентов (Xilinx, Altera, Analog Devices, Intersil, Interpoint, Microsemi, Aeroflex, Peregrine, Syfer, Eurofarad, Texas Instrument, Miteq, Cobham, E2V, MA-COM, Hittite, Mini-Circuits, General Dynamics и др.);

Помимо этого, одним из направлений компании «ЭлектроПласт» является направление «Источники питания». Мы предлагаем Вам помощь Конструкторского отдела:

- Подбор оптимального решения, техническое обоснование при выборе компонента;
- Подбор аналогов;
- Консультации по применению компонента;
- Поставка образцов и прототипов;
- Техническая поддержка проекта;
- Защита от снятия компонента с производства.



Как с нами связаться

Телефон: 8 (812) 309 58 32 (многоканальный)

Факс: 8 (812) 320-02-42

Электронная почта: org@eplast1.ru

Адрес: 198099, г. Санкт-Петербург, ул. Калинина, дом 2, корпус 4, литера А.