

E-Rated Medium Voltage Fuses For Transformer and Feeder Protection 5.5 kV

MV055



CATALOG SYMBOL: MV055

E-RATED MEDIUM VOLTAGE FUSES:

Meets E requirements per ANSI C37.46

Meets Full Range requirements per ANSI C37.40

FOR TRANSFORMER AND FEEDER PROTECTION

VOLTAGE RATING: 5.5 KV

INTERRUPTING RATING: 50KA Maximum Sym.

CURRENT LIMITING

CONSTRUCTION: Silver ribbon element surrounded by silica filler housed in a fiberglass tube and plated endcaps. An epoxy paint protects the fuse tube from the surrounding environment.

AGENCY INFORMATION: UL pending.

FEATURES:

• **Standard Clip Center Lengths and Barrel Diameters.**

The new line of Bussmann medium voltage fuses have a standard clip center distance of 12 inches and barrel diameters of 2 or 3 inches which allow fuses to retrofit existing hardware.

• **Open Fuse Indication with Indicator.**

• **100% Tested for Reliability.** All medium voltage fuses are pulsed twice with 90% of their minimum melt I²t to guarantee undamaged elements. This test does not affect undamaged elements. A damaged element completely opens when subjected to 90% of the minimum melt I²t, allowing it to be detected by a resistance check.

• **Full Range Fuses.** Bussmann medium voltage fuses provide full range protection and are capable of interrupting fault currents up to 50,000A sym.

• **Time Current Curves and Dimensional Data:**

MV055F1CA series, see page 2;

MV055F1DA series, see page 3.

• **Peak Arc Voltage Curves, and Peak Let-Through Data,** see page 4.

• **Fuse Clips,** see page 4.

Electrical Characteristics

Part Number †	Ampere Rating	Min. Melt I ² t	Max. Clear I ² t	Physical Size			
				Length	Dia.	Clip Center	Barrels
MV055F1CAX5E	5A	180	2400	15.75	2	12	1
MV055F1CAX7E	7A	850	8000				
MV055F1CAX10E	10A	850	8000				
MV055F1CAX15E	15A	2070	11000				
MV055F1CAX20E	20A	2370	23000				
MV055F1CAX25E	25A	4650	31000				
MV055F1CAX30E	30A	9490	45000				
MV055F1CAX40E	40A	9490	45000				
MV055F1CAX50E	50A	13600	90000				
MV055F1CAX65E	65A	30700	181000				
MV055F1DAX10E	10A	850	8000	15.75	3	12	1
MV055F1DAX15E	15A	2070	12000				
MV055F1DAX20E	20A	2370	23000				
MV055F1DAX25E	25A	4650	31000				
MV055F1DAX30E	30A	9490	45000				
MV055F1DAX40E	40A	9490	45000				
MV055F1DAX50E	50A	13600	90000				
MV055F1DAX65E	65A	30700	181000				
MV055F1DAX80E	80A	54600	270000				
MV055F1DAX100E	100A	116200	580000				
MV055F1DAX125E	125A	167400	600000	15.75	3	12	1
MV055F1DAX150E	150A	218700	786000				
MV055F1DAX175E	175A	227900	1100000				
MV055F1DAX200E	200A	297600	1520000				
MV055F2DAX250E	250A	669600	2400000				
MV055F2DAX300E	300A	874800	3149000	15.75	3	12	2
MV055F2DAX350E	350A	911600	4376000				
MV055F2DAX400E	400A	1190400	6071000				
MV055F2DAX450E	450A	1555000	9796000				

†To order fuses with the optional striker pin, see Part Number Construction chart below.

Part Number Construction

	Medium Voltage	Voltage Rating		Number of Barrels	Barrel Diameter	Clip Center Distance	Indication Type	Ampere Rating
Example	MV	055	F	1	C	A	X	5E
		055 = 5.5 KV	F = Full Range	1	C = 2 inches	A = 12 inches	X = Indicator only	
		155 = 15.5 KV		2	D = 3 inches	B = 15 inches	S = Striker Pin	
						C = 18 inches		

E-Rated Medium Voltage Fuses For Transformer and Feeder Protection 5.5 kV - MV055F1CA Series

MV055

Time-Current Characteristics
Minimum Melt

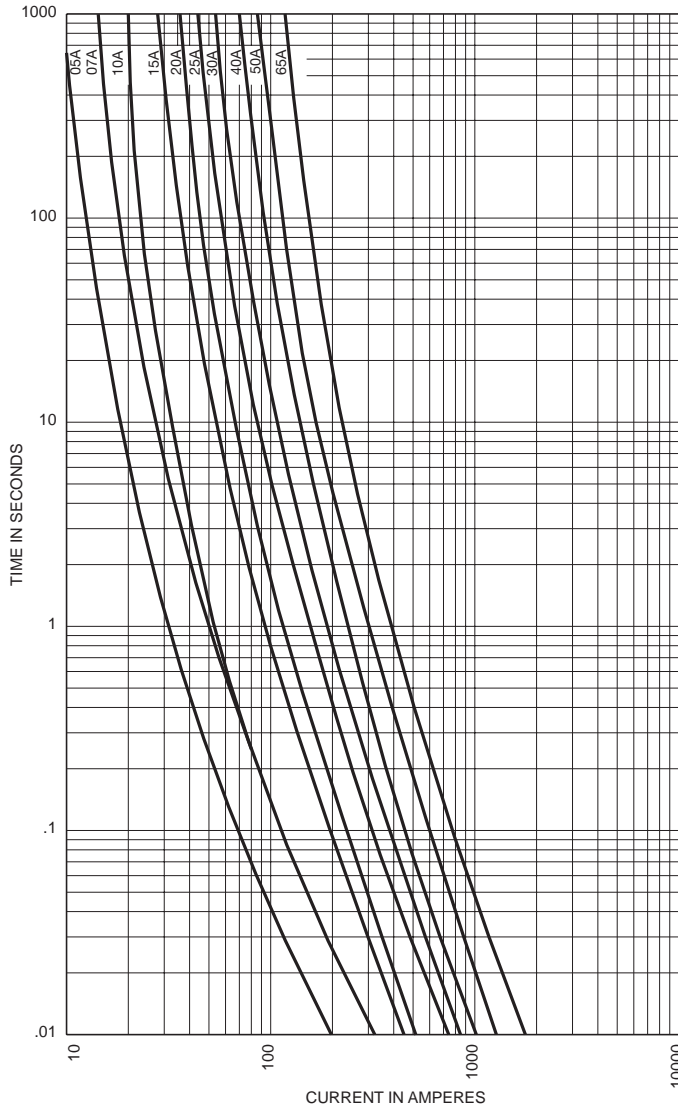

Time-Current Characteristics
Total Clear

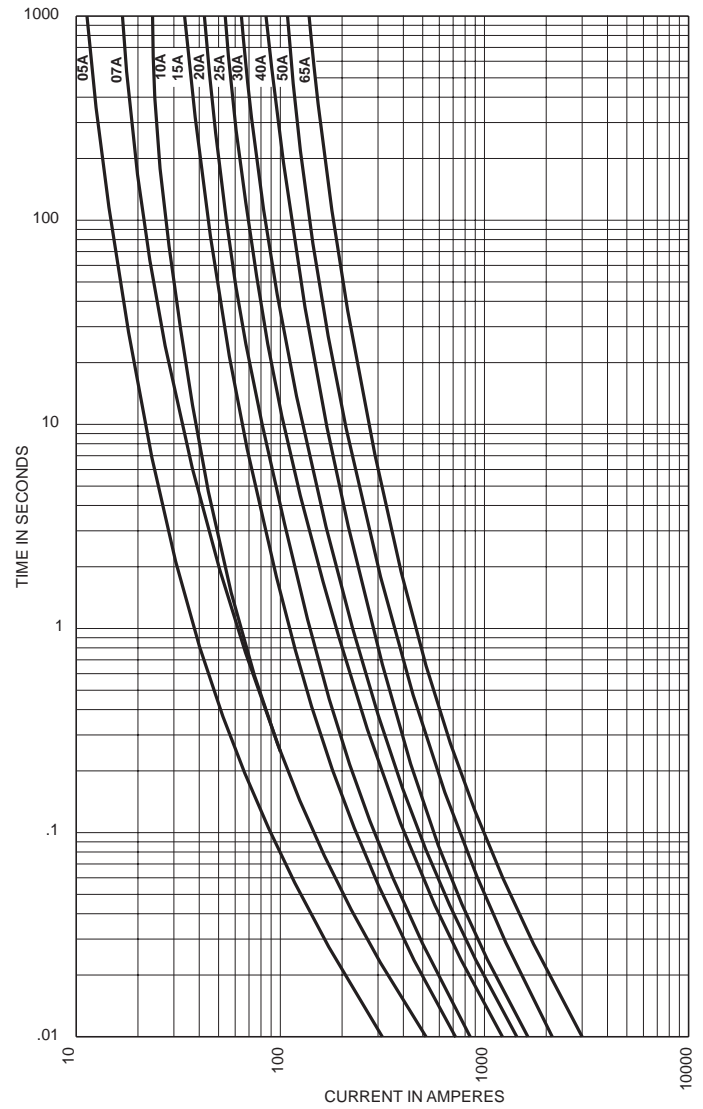

MV055F1CAX

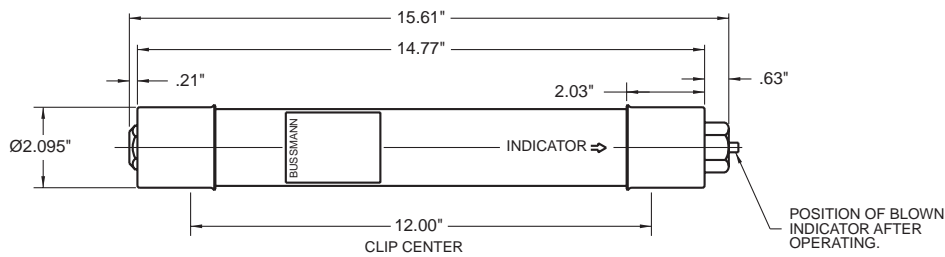

E-Rated Medium Voltage Fuses For Transformer and Feeder Protection 5.5 kV - MV055F1DA Series

MV055

Time-Current Characteristics
Minimum Melt

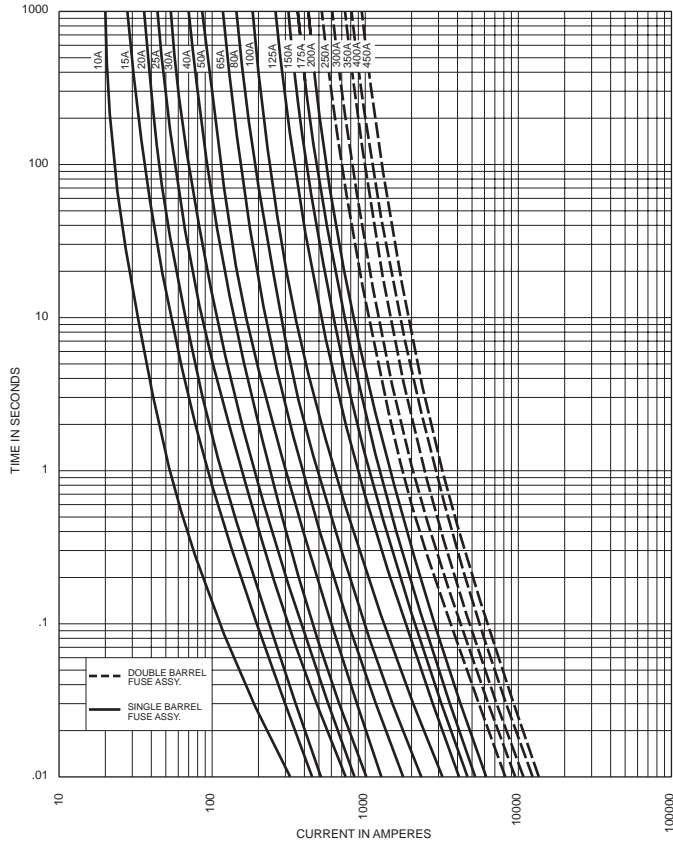

Time-Current Characteristics
Total Clear

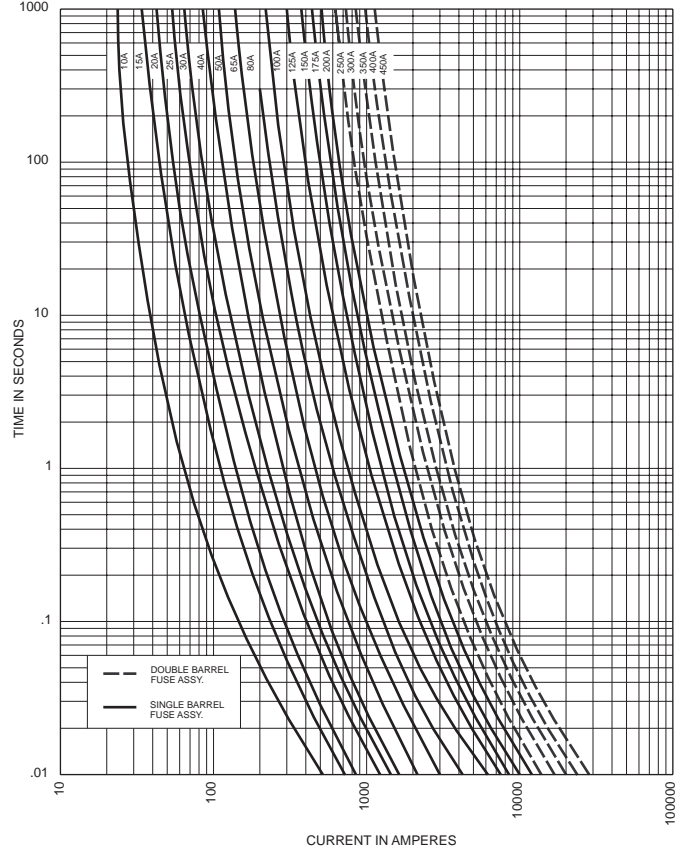

MV055F1DAX

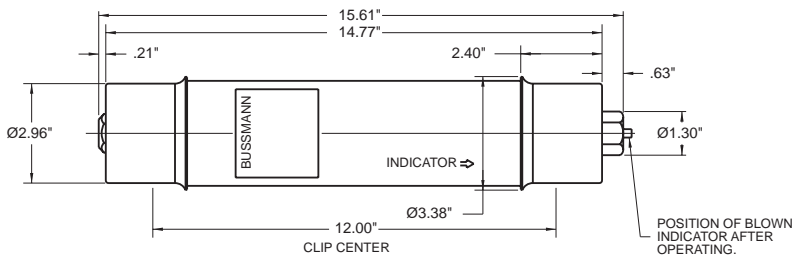

Double Barrel Dimensions

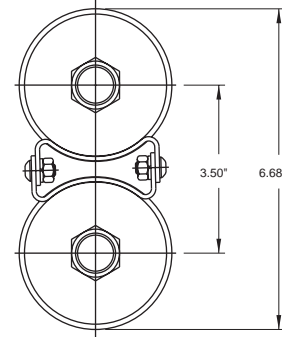

E-Rated Medium Voltage Fuses For Transformer and Feeder Protection 5.5 kV - Peak Arc Voltage & Peak Let-Through Data

MV055

Max. Peak Let-Through Current Curves

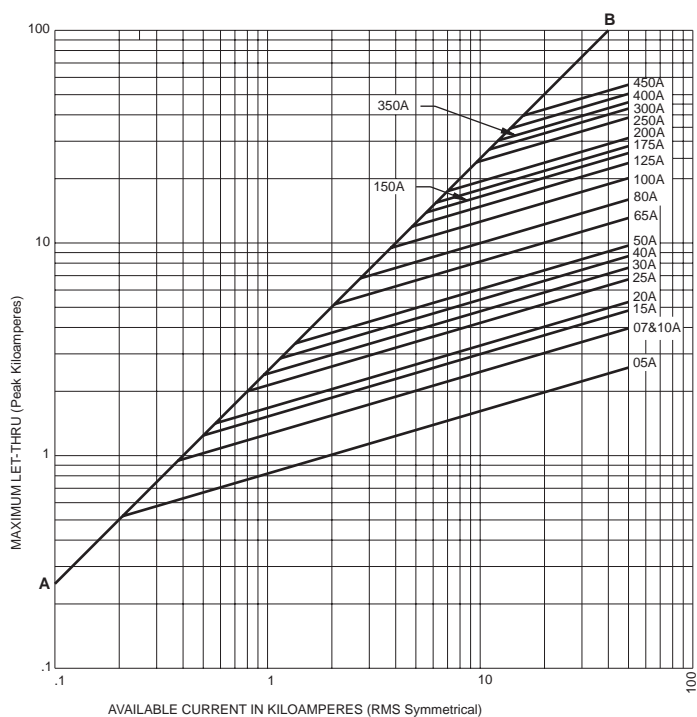

MAXIMUM PEAK ARC VOLTAGE FOR
"E" RATED FULL RANGE POWER FUSE
(BUSSMANN)

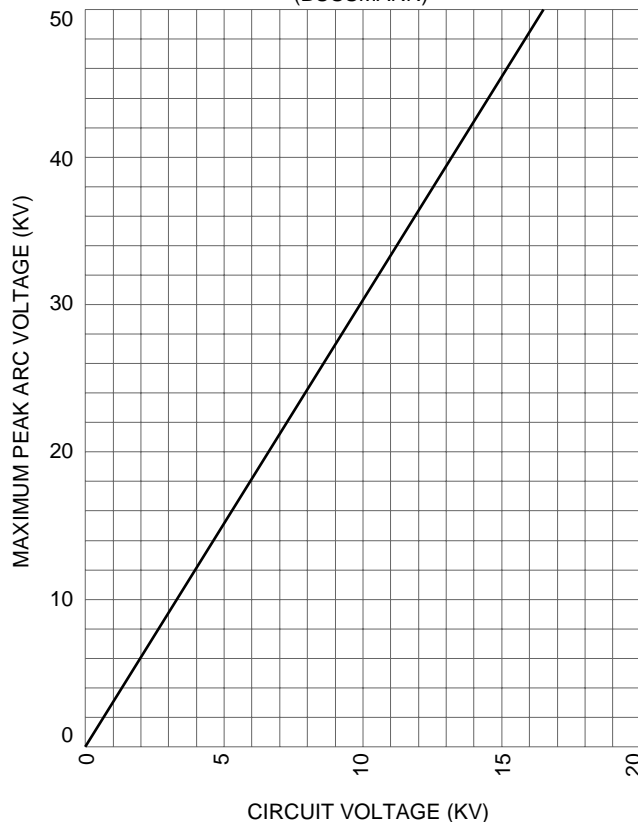

Recommended Fuse Clips for Medium Voltage Fuses

Part No.	Fuse Diameter	Clip Dimensions						
		A	B	C	D	E	F	G
A3354710	2"	3.74"	1.97"	2.00"	1.18"	4.53"	1.50"	.39"
A3354730	3"	4.13"	2.44"	3.00"	1.18"	5.63"	1.50"	.39"

Fuseclips are for single barrel applications up to 200E.

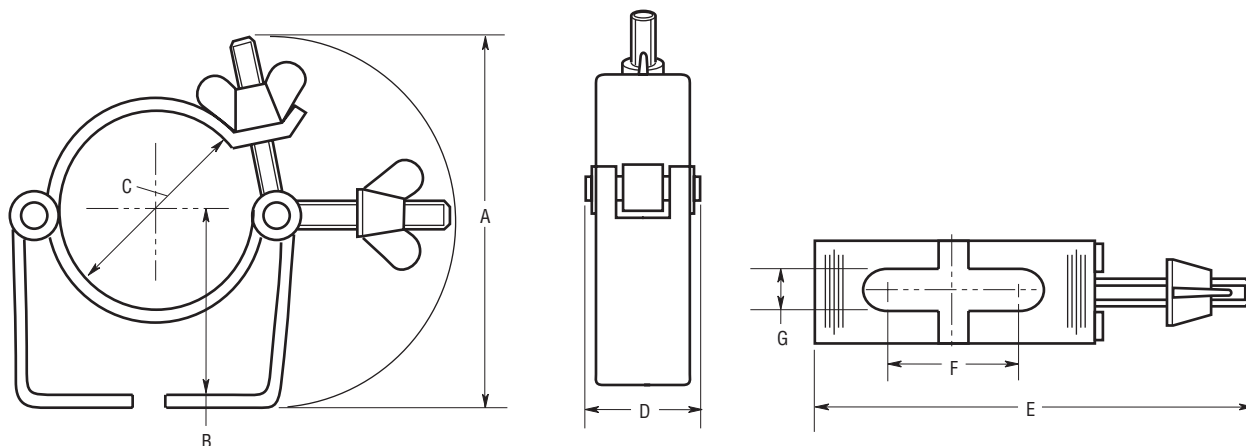



Компания «ЭлектроПласт» предлагает заключение долгосрочных отношений при поставках импортных электронных компонентов на взаимовыгодных условиях!

Наши преимущества:

- Оперативные поставки широкого спектра электронных компонентов отечественного и импортного производства напрямую от производителей и с крупнейших мировых складов;
- Поставка более 17-ти миллионов наименований электронных компонентов;
- Поставка сложных, дефицитных, либо снятых с производства позиций;
- Оперативные сроки поставки под заказ (от 5 рабочих дней);
- Экспресс доставка в любую точку России;
- Техническая поддержка проекта, помощь в подборе аналогов, поставка прототипов;
- Система менеджмента качества сертифицирована по Международному стандарту ISO 9001;
- Лицензия ФСБ на осуществление работ с использованием сведений, составляющих государственную тайну;
- Поставка специализированных компонентов (Xilinx, Altera, Analog Devices, Intersil, Interpoint, Microsemi, Aeroflex, Peregrine, Syfer, Eurofarad, Texas Instrument, Miteq, Cobham, E2V, MA-COM, Hittite, Mini-Circuits, General Dynamics и др.);

Помимо этого, одним из направлений компании «ЭлектроПласт» является направление «Источники питания». Мы предлагаем Вам помощь Конструкторского отдела:

- Подбор оптимального решения, техническое обоснование при выборе компонента;
- Подбор аналогов;
- Консультации по применению компонента;
- Поставка образцов и прототипов;
- Техническая поддержка проекта;
- Защита от снятия компонента с производства.



Как с нами связаться

Телефон: 8 (812) 309 58 32 (многоканальный)

Факс: 8 (812) 320-02-42

Электронная почта: org@eplast1.ru

Адрес: 198099, г. Санкт-Петербург, ул. Калинина, дом 2, корпус 4, литера А.