

FEATURES

- Universal low cost modulator solution for communications applications
- DC to 80 MHz output bandwidth
- Integrated 12-bit D/A converter
- Programmable sample rate interpolation filter
- Programmable reference clock multiplier
- Internal $\text{SIN}(x)/x$ compensation filter
- >52 dB SFDR @ 40 MHz A_{OUT}
- >48 dB SFDR @ 70 MHz A_{OUT}
- >80 dB narrow-band SFDR @ 70 MHz A_{OUT}
- +3 V single-supply operation
- Space-saving surface-mount packaging
- Bidirectional control bus interface
- Supports burst and continuous Tx modes
- Single-tone mode for frequency synthesis applications
- Four programmable, pin-selectable, modulator profiles
- Direct interface to AD8320/AD8321 PGA cable driver

APPLICATIONS

- HFC data, telephony, and video modems
- Wireless and satellite communications
- Cellular base stations

GENERAL DESCRIPTION

The AD9856 integrates a high speed, direct digital synthesizer (DDS), a high performance, high speed, 12-bit digital-to-analog converter (DAC), clock multiplier circuitry, digital filters, and other DSP functions on a single chip to form a complete quadrature digital upconverter device. The AD9856 is intended to function as a universal I/Q modulator and agile upconverter for communications applications where cost, size, power dissipation, and dynamic performance are critical attributes.

The AD9856 is available in a space-saving surface-mount package, and is specified to operate over the extended industrial temperature range of -40°C to $+85^{\circ}\text{C}$.

FUNCTIONAL BLOCK DIAGRAM

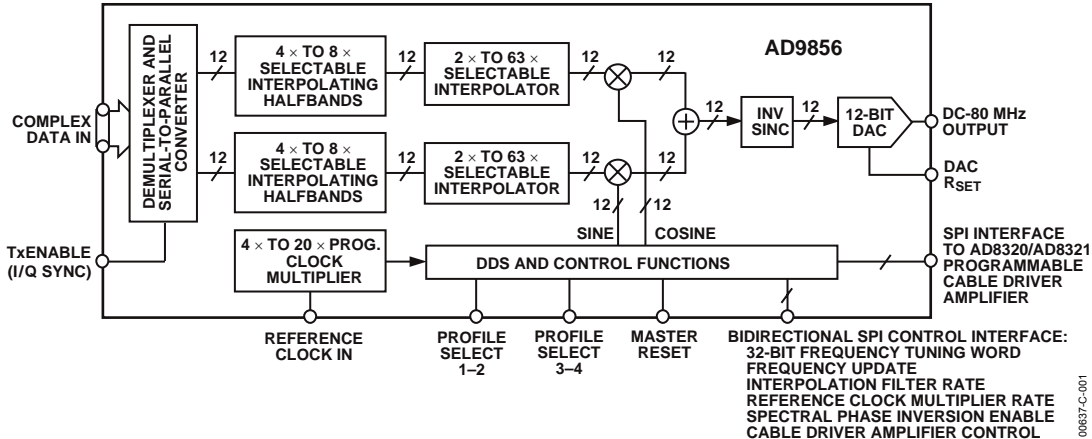

Figure 1.

Rev. C

Information furnished by Analog Devices is believed to be accurate and reliable. However, no responsibility is assumed by Analog Devices for its use, nor for any infringements of patents or other rights of third parties that may result from its use. Specifications subject to change without notice. No license is granted by implication or otherwise under any patent or patent rights of Analog Devices. Trademarks and registered trademarks are the property of their respective owners.

TABLE OF CONTENTS

Specifications.....	3	Digital Quadrature Modulator	23
Absolute Maximum Ratings.....	5	Inverse Sinc Filter (ISF)	24
Explanation of Test Levels	5	Direct Digital Synthesizer Function	25
ESD Caution.....	5	D/A Converter	25
Pin Configuration and Function Descriptions.....	6	Reference Clock Multiplier	26
Typical Performance Characteristics	8	Throughput and Latency.....	26
Typical Modulated Output Spectral Plots	8	Control Interface	26
Typical Single-Tone Output Spectral Plots	9	General Operation of the Serial Interface.....	26
Typical Narrow-Band SFDR Spectral Plots	10	Instruction Byte	27
Typical Phase Noise Spectral Plots.....	10	Serial Interface Port Pin Descriptions	28
Typical Plots of Output Constellations.....	11	MSB/LSB Transfers	28
Power Consumption	12	Notes on Serial Port Operation	28
Serial Control Bus Register	13	Programming/Writing the AD8320/AD8321 Cable Driver Amplifier Gain Control.....	30
Register Bit Definitions.....	14	Understanding and Using Pin-Selectable Modulator Profiles	31
Theory of Operation	15	Power Dissipation Considerations.....	31
Modulation Mode Operation	15	AD9856 Evaluation Board	32
Input Word Rate (f_w) vs. REFCLK Relationship	16	Support	32
I/Q Data Synchronization	16	Outline Dimensions	35
Half-Band Filters (HBFs)	20	Ordering Guide	35
Cascaded Integrator Comb (CIC) Filter.....	21		

REVISION HISTORY

1/05—Rev. B to Rev. C

Updated Format.....	Universal
Changes to Table 2.....	5
Changes to Input Word Rate (f_w) vs. REFCLK Relationship Section.....	16
Changes to Cascaded Integrator Comb (CIC) Filter Section ...	21
Updates to Direct Digital Synthesizer Function Section.....	25
Added Support Section.....	32
Updated Outline Dimensions	35
Changes to Ordering Guide	35

9/99—Rev. A to Rev. B

SPECIFICATIONS

$V_S = +3\text{ V} \pm 5\%$, $R_{SET} = 3.9\text{ k}\Omega$, external reference clock frequency = 10 MHz with REFCLK multiplier enabled at 20 \times .

Table 1.

Parameter	Temp	Test Level	Min	Typ	Max	Unit
REF CLOCK INPUT CHARACTERISTICS						
Frequency Range						
REFCLK Multiplier Disabled	Full	VI	5		200 ¹	MHz
REFCLK Multiplier Enabled at 4 \times	Full	VI	5		50	MHz
REFCLK Multiplier Enabled at 20 \times	Full	VI	5		10	MHz
Duty Cycle	25°C	V		50		%
Input Capacitance	25°C	V		3		pF
Input Impedance	25°C	V		100		M Ω
DAC OUTPUT CHARACTERISTICS						
Resolution				12		Bits
Full-Scale Output Current			5	10	20	mA
Gain Error	25°C	I	-10		+10	%FS
Output Offset	25°C	I			10	μ A
Differential Nonlinearity	25°C	V		0.5		LSB
Integral Nonlinearity	25°C	V		1		LSB
Output Capacitance	25°C	V		5		pF
Phase Noise @ 1 kHz Offset, 40 MHz A _{OUT}						
REFCLK Multiplier Enabled at 20 \times	25°C	V		-85		dBc/Hz
REFCLK Multiplier at 4 \times	25°C	V		-100		dBc/Hz
REFCLK Multiplier Disabled	25°C	V		-110		dBc/Hz
Voltage Compliance Range	25°C	I	-0.5		1.5	V
Wideband SFDR:						
1 MHz Analog Out	25°C	IV		70		dBc
20 MHz Analog Out	25°C	IV		65		dBc
42 MHz Analog Out	25°C	IV		60		dBc
65 MHz Analog Out	25°C	IV		55		dBc
80 MHz Analog Out	25°C	IV		50		dBc
Narrow-Band SFDR: (± 100 kHz Window)						
70 MHz Analog Out	25°C	IV		80		dBc
MODULATOR CHARACTERISTICS						
Adjacent Channel Power (CH Power = -6.98 dBm)	25°C	IV	50			dBm
Error Vector Magnitude	25°C	IV		1	2	%
I/Q Offset	25°C	IV	50	55		dB
Inband Spurious Emissions	25°C	IV	45	50		dBc
Pass-Band Amplitude Ripple (DC to 80 MHz)	25°C	V		± 0.3		dB

¹ For 200 MHz operation in modulation mode at 85°C operating temperature, V_S must be 3 V minimum.

AD9856

Parameter	Temp	Test Level	Min	Typ	Max	Unit
TIMING CHARACTERISTICS						
Serial Control Bus						
Maximum Frequency	Full	IV			10	MHz
Minimum Clock Pulse Width High (t_{PWH})	Full	IV	30			ns
Minimum Clock Pulse Width Low (t_{PWL})	Full	IV	30			ns
Maximum Clock Rise/Fall Time	Full	IV			1	ms
Minimum Data Setup Time (t_{DS})	Full	IV	25			ns
Minimum Data Hold Time (t_{DH})	Full	IV	0			ns
Maximum Data Valid Time (t_{DV})	Full	IV	30			ns
Wake-Up Time ²	Full	IV			1	ms
Minimum RESET Pulse Width High (t_{RH})	Full	IV	5			REFCLK cycles
CMOS LOGIC INPUTS						
Logic 1 Voltage	25°C	I	2.6			V
Logic 0 Voltage	25°C	I			0.4	V
Logic 1 Current	25°C	I			12	μA
Logic 0 Current	25°C	I			12	μA
Input Capacitance	25°C	V		3		pF
CMOS LOGIC OUTPUTS (1 mA LOAD)						
Logic 1 Voltage	25°C	I	2.7			mA
Logic 0 Voltage	25°C	I			0.4	mA
POWER SUPPLY						
+V _S Current						
Full Operating Conditions ³	25°C	I			530	mA
Burst Operation (25%)	25°C	I			450	mA
Single-Tone Mode	25°C	I			495	mA
160 MHz Clock	25°C	I			445	mA
120 MHz Clock	25°C	I			345	mA
Power-Down Mode	25°C	I			2	mA

² Assuming 1.3 kΩ and 0.01 μF loop filter components.

³ Assuming 1.3 kW and 0.01 mF loop filter components.

ABSOLUTE MAXIMUM RATINGS

Absolute maximum ratings are limiting values, to be applied individually, and beyond which the serviceability of the circuit may be impaired. Functional operability under any of these conditions is not necessarily implied. Exposure of absolute maximum rating conditions for extended periods of time may affect device reliability.

Table 2.

Parameter	Rating
Maximum Junction Temperature	150°C
Storage Temperature	-65°C to +150°C
V _s	4 V
Operating Temperature	-40°C to +85°C
Digital Inputs	-0.7 V to +V _s
Lead Temperature (Soldering 10 sec)	300°C
Digital Output Current	5 mA
θ _{JA} Thermal Impedance	38°C/W

EXPLANATION OF TEST LEVELS

- I. 100% production tested.
- III. Sample tested only.
- IV. Parameter is guaranteed by design and characterization testing.
- V. Parameter is a typical value only.
- VI. Devices are 100% production tested at 25°C and guaranteed by design and characterization testing for industrial operating temperature range.

ESD CAUTION

ESD (electrostatic discharge) sensitive device. Electrostatic charges as high as 4000 V readily accumulate on the human body and test equipment and can discharge without detection. Although this product features proprietary ESD protection circuitry, permanent damage may occur on devices subjected to high energy electrostatic discharges. Therefore, proper ESD precautions are recommended to avoid performance degradation or loss of functionality.



PIN CONFIGURATION AND FUNCTION DESCRIPTIONS

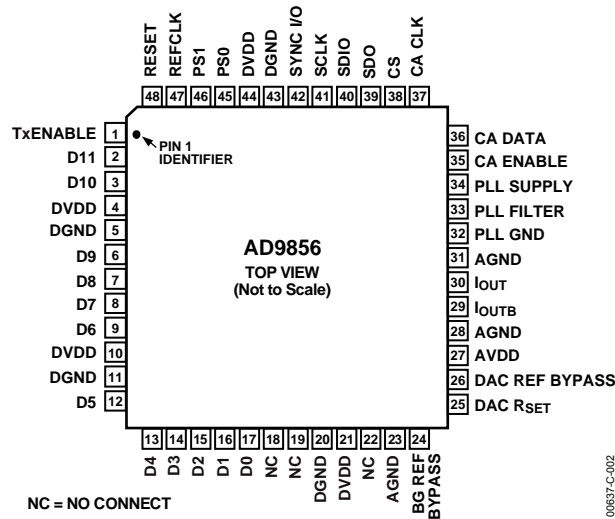

Figure 2. Pin Configuration

Table 3. Pin Function Descriptions

Pin No.	Mnemonic	Pin Function	Pin No.	Mnemonic	Pin Function
1	TxENABLE	Input Pulse that Synchronizes the Data Stream	32	PLL GND	PLL Ground
2	D11	Input Data (Most Significant Bit)	33	PLL FILTER	PLL Loop Filter Connection
3	D10	Input Data	34	PLL SUPPLY	PLL Voltage Supply
4, 10, 21, 44	DVDD	Digital Supply Voltage	35	CA ENABLE	Cable Driver Amp Enable
5, 11, 20, 43	DGND	Digital Ground	36	CA DATA	Cable Driver Amp Data
6 to 9	D9 to D6	Input Data	37	CA CLK	Cable Driver Amp Clock
12 to 16	D5 to D1	Input Data	38	\overline{CS}	Chip Select
17	D0	Input Data (Least Significant Bit)	39	SDO	Serial Data Output
18, 19, 22	NC	No Internal Connection	40	SDIO	Serial Port I/O
23, 28, 31	AGND	Analog Ground	41	SCLK	Serial Port Clock
24	BG REF BYPASS	No External Connection ¹	42	SYNC I/O	Performs I/O Synchronization
25	DAC R _{SET}	R _{SET} Resistor Connection	45	PS0	Profile Select 0
26	DAC REF BYPASS	No External Connection	46	PS1	Profile Select 1
27	AVDD	Analog Supply Voltage	47	REFCLK	Reference Clock Input
29	I _{OUTB}	Complementary Analog Current Output of the DAC	48	RESET	Master Reset
30	I _{OUT}	True Analog Current Output of DAC			

¹ In most cases, optimal performance is achieved with no external connection. For extremely noisy environments, BG REF BYPASS can be bypassed with up to a 0.1 μ F capacitor to AGND (Pin 23). DAC REF BYPASS can be bypassed with up to a 0.1 μ F capacitor to AVDD (Pin 27).

Table 4. Functional Block Mode Descriptions

Functional Block	Mode Description
Operating Modes	1. Complex quadrature modulator mode. 2. Single-tone output mode.
Input Data Format	Programmable: 12-bit, 6-bit, or 3-bit input formats. Data input to the AD9856 is 12-bit, twos complement. Complex I/Q symbol component data is required to be at least 2× oversampled, depending upon configuration.
Input Sample Rate	Up to 50 Msamples/sec @ 200 MHz SYSCLK rate.
Input Reference Clock Frequency	For DC to 80 MHz A _{OUT} operation (200 MHz SYSCLK rate) with REFCLK multiplier enabled: 10 MHz to 50 MHz, programmable via control bus; with REFCLK multiplier disabled: 200 MHz. Note: For optimum data synchronization, the AD9856 reference clock and the input data clock should be derived from the same clock source.
Internal Reference Clock Multiplier	Programmable in integer steps over the range of 4× to 20×. Can be disabled (effective REFCLK multiplier = 1) via control bus. Output of REFCLK multiplier = SYSCLK rate, which is the internal clock rate applied to the DDS and DAC function.
Profile Select	Four pin-selectable, preprogrammed formats. Available for modulation and single-tone operating modes.
Interpolating Range	Fixed 4×, selectable 2×, and selectable 2× to 63× range.
Half-Band Filters	Interpolating filters that provide upsampling and reduce the effects of the CIC passband roll-off characteristics.
TxENABLE Function–Burst Mode	When burst mode is enabled via the control bus, the rising edge of the applied TxENABLE pulse should be coincident with, and frame, the input data packet. This establishes data sampling synchronization.
TxENABLE Function–Continuous Mode	When continuous mode is enabled via the control bus, the TxENABLE pin becomes an I/Q control line. A Logic 1 on TxENABLE indicates I data is being presented to the AD9856. A Logic 0 on TxENABLE indicates Q data is being presented to the AD9856. Each rising edge of TxENABLE resynchronizes the AD9856 input sampling capability.
Inverse SINC Filter	Precompensates for SIN(x)/x roll-off of DAC; user bypassable.
I/Q Channel Invert	[I ×Cos(ωt) + Q ×Sin(ωt)] or [I ×Cos(ωt) – Q ×Sin(ωt)] (default), configurable via control bus, per profile.
Full Sleep Mode	Power dissipation reduced to less than 6 mW when full sleep mode is active; programmable via the control bus.

TYPICAL PERFORMANCE CHARACTERISTICS

TYPICAL MODULATED OUTPUT SPECTRAL PLOTS

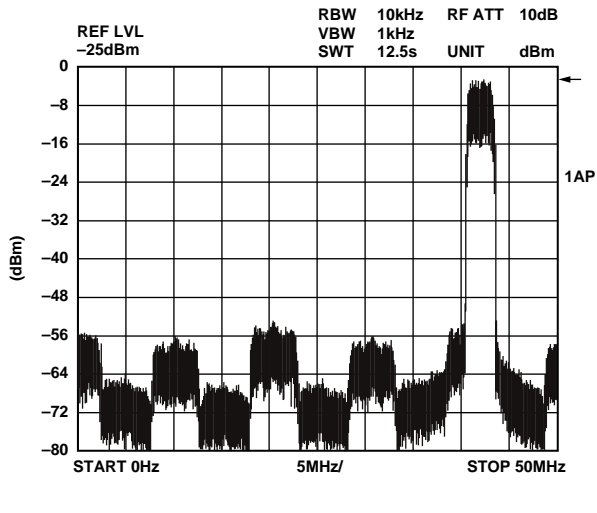

Figure 3. QPSK at 42 MHz and 2.56 MS/sec; 10.24 MHz External Clock with REFCLK Multiplier = 12, CIC = 3, HB3 On, 2x Data

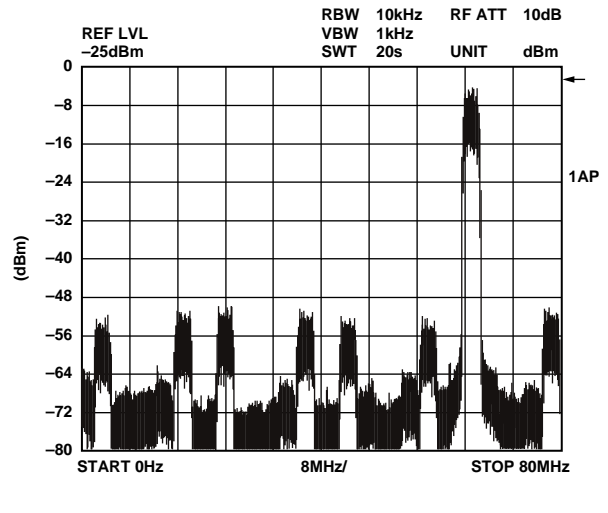

Figure 5. 16-QAM at 65 MHz and 2.56 MS/sec; 10.24 MHz External Clock with REFCLK Multiplier = 18, CIC = 9, HB3 Off, 2x Data

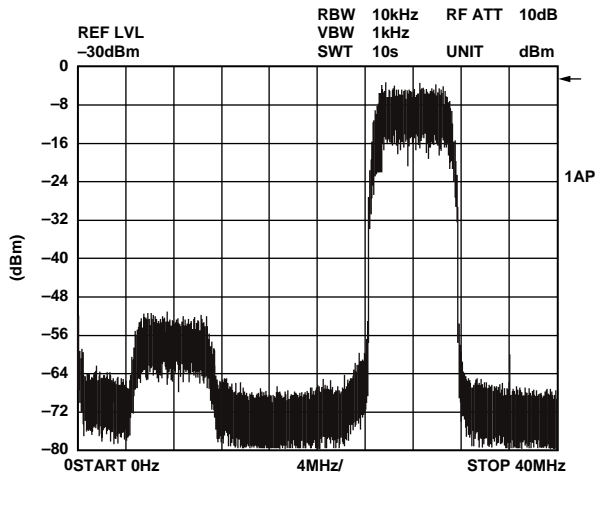

Figure 4. 64-QAM at 28 MHz and 6 MS/sec; 36 MHz External Clock with REFCLK Multiplier = 4, CIC = 2, HB3 Off, 3x Data

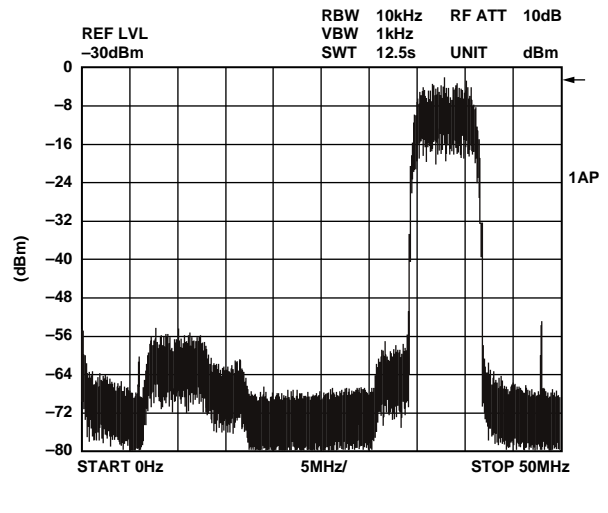

Figure 6. 256-QAM at 38 MHz and 6 MS/sec; 48 MHz External Clock with REFCLK Multiplier = 4, CIC = 2, HB3 Off, 4x Data

TYPICAL SINGLE-TONE OUTPUT SPECTRAL PLOTS

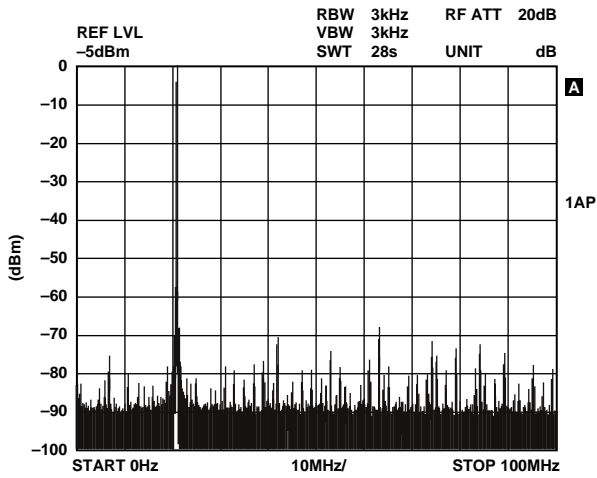

Figure 7. 21 MHz CW Output

00637-C-007

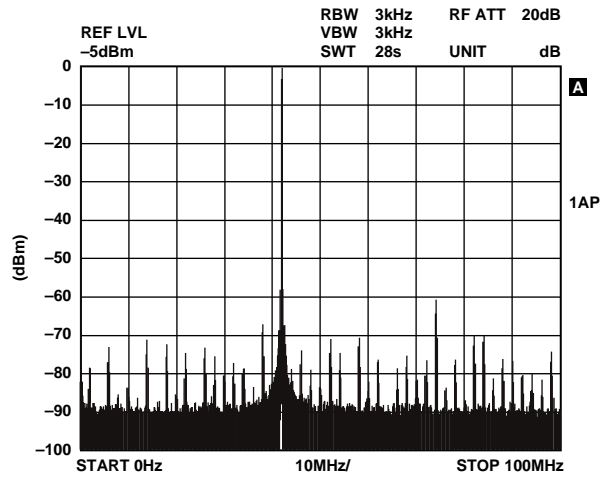

Figure 9. 42 MHz CW Output

00637-C-009

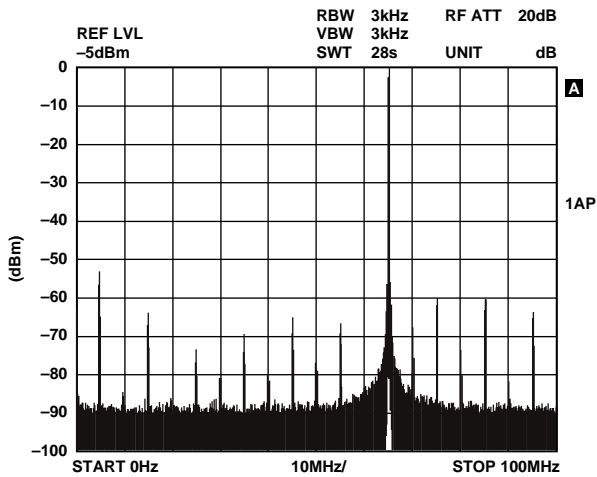

Figure 8. 65 MHz CW Output

00637-C-008

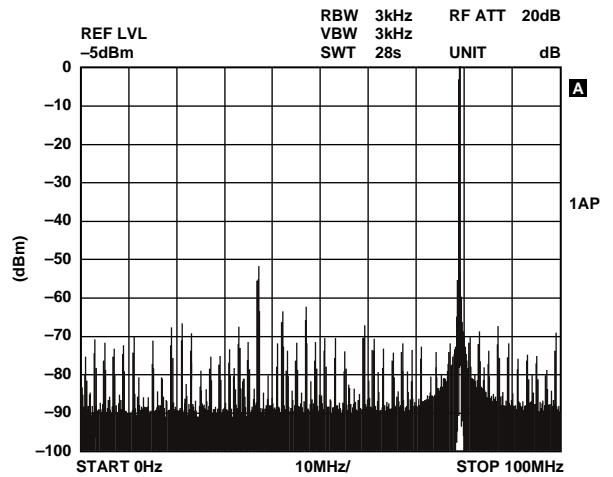
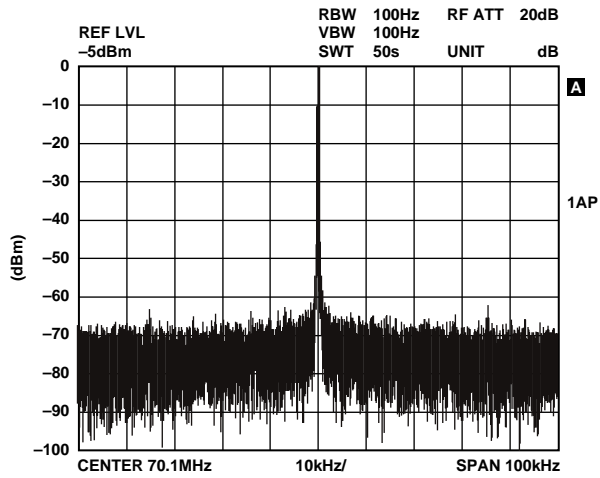

Figure 10. 79 MHz CW Output

00637-C-010

TYPICAL NARROW-BAND SFDR SPECTRAL PLOTS



00837-C-011

Figure 11. 70.1 MHz Narrow-Band SFDR, 10 MHz External Clock with REFCLK Multiplier = 20x

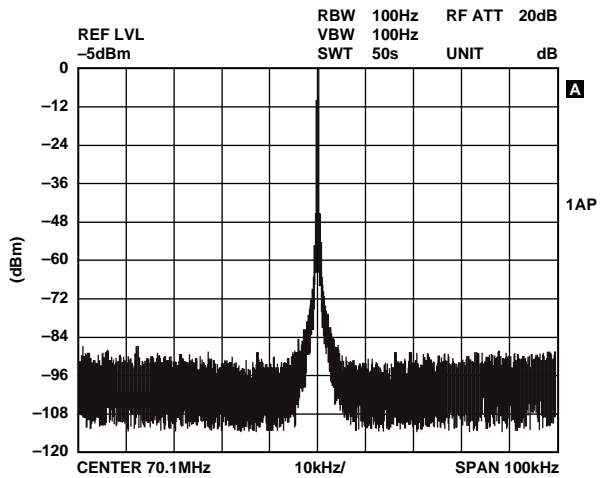

00837-C-012

Figure 12. 70.1 MHz Narrow-Band SFDR, 200 MHz External Clock with REFCLK Multiplier Disabled

TYPICAL PHASE NOISE SPECTRAL PLOTS

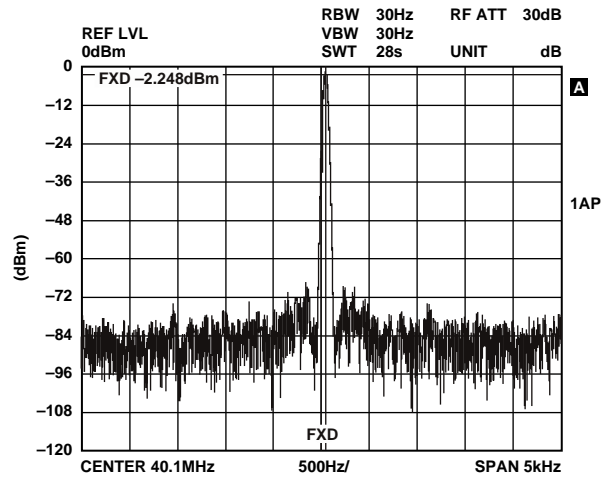

00837-C-013

Figure 13. 40.1 MHz Output, 10 MHz External Clock with REFCLK Multiplier = 20x

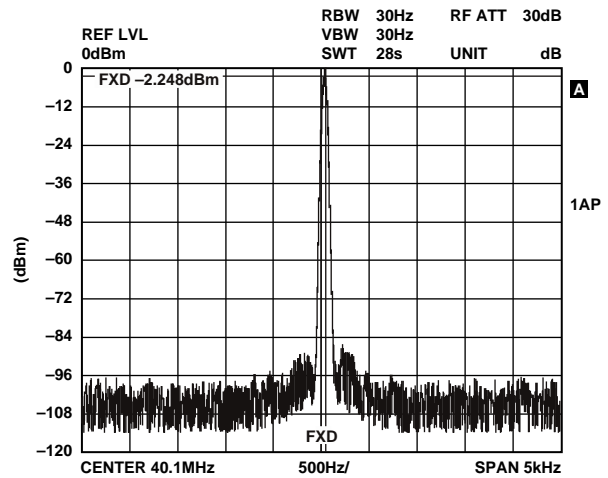

00837-C-014

Figure 14. 40.1 MHz Output, 200 MHz External Clock with REFCLK Multiplier Disabled

TYPICAL PLOTS OF OUTPUT CONSTELLATIONS

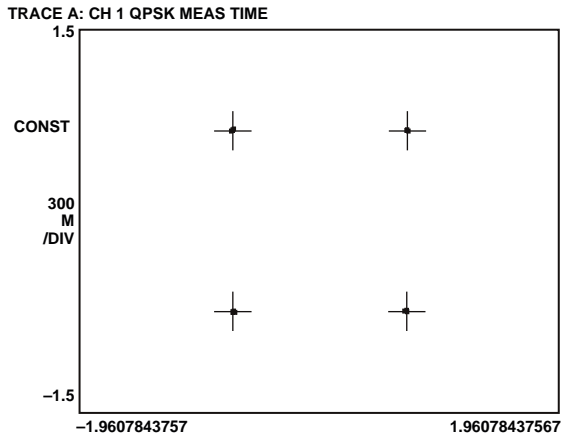

Figure 15. QPSK, 65 MHz, 2.56 MS/sec

00637-C-015

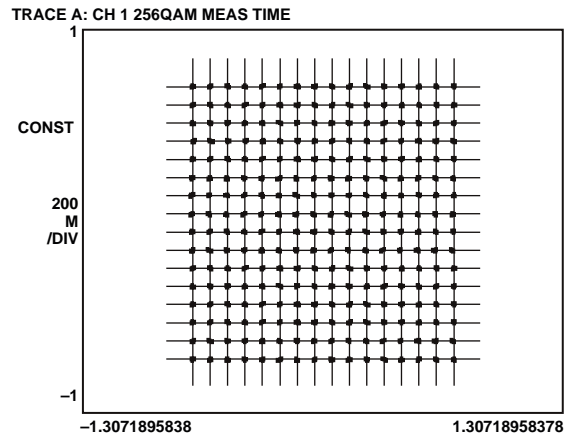

Figure 18. 256-QAM, 42 MHz, 6 MS/sec

00637-C-018

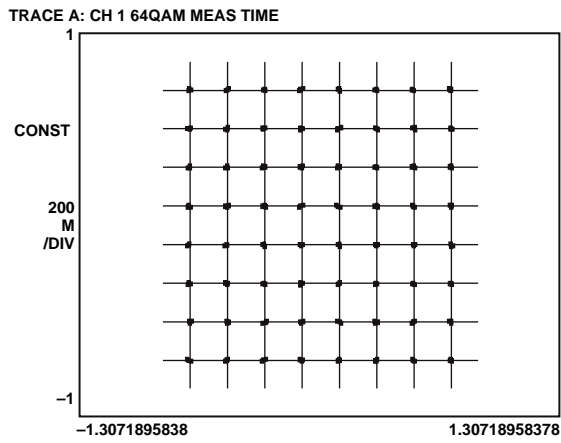

Figure 16. 64-QAM, 42 MHz, 6 MS/sec

00637-C-016

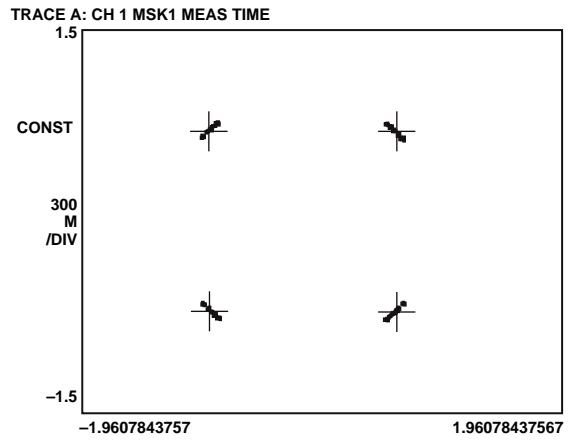

Figure 19. GMSK Modulation, 13 MS/sec

00637-C-019

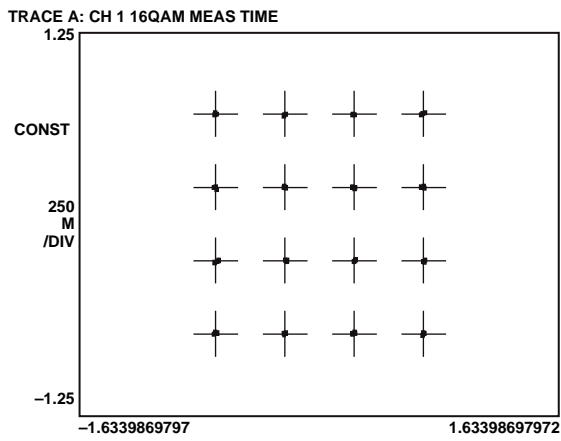
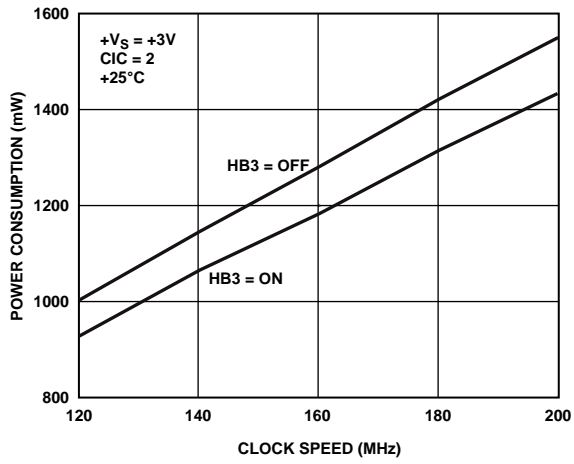

Figure 17. 16-QAM, 65 MHz, 2.56 MS/sec

00637-C-017

POWER CONSUMPTION



00837-C-020

Figure 20. Power Consumption vs. Clock Speed; $V_S = 3 V$, CIC = 2, $25^\circ C$

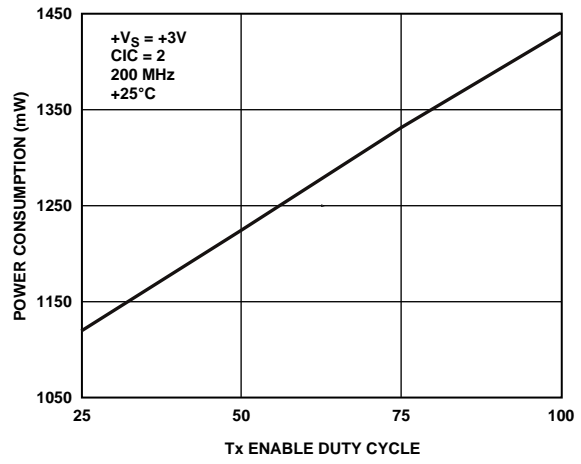

00837-C-022

Figure 22. Power Consumption vs. Burst Duty Cycle; $V_S = 3 V$, CIC = 2, 200 MHz, $25^\circ C$

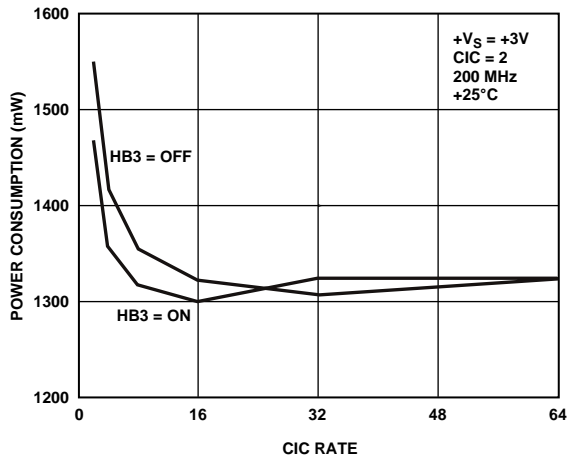

00837-C-021

Figure 21. Power Consumption vs. CIC Rate; $V_S = 3 V$, 200 MHz, $25^\circ C$

SERIAL CONTROL BUS REGISTER

Table 5. Serial Control Bus Register Layout

Register	AD9856 Register Layout									Profile
Address (hex)	Bit 7	Bit 6	Bit 5	Bit 4	Bit 3	Bit 2	Bit 1	Bit 0	Default (hex)	
00	SDO Active	LSB First	REFCLK Mult.<4>	REFCLK Mult.<3>	REFCLK Mult.<2>	REFCLK Mult.<1>	REFCLK Mult.<0>	Reserved	15	N/A
01	CIC Gain	Continuous Mode	Full Sleep Mode	Single-tone Mode	Bypass Inverse Sinc Filter	Bypass REFCLK Mult.	Input Format Select <1>	Input Format Select <0>	06	N/A
02	Frequency Tuning Word <7:0>								04	1
03	Frequency Tuning Word <15:8>								00	1
04	Frequency Tuning Word <23:16>								00	1
05	Frequency Tuning Word <31:24>								00	1
06	Interpolator Rate <5>	Interpolator Rate <4>	Interpolator Rate <3>	Interpolator Rate <2>	Interpolator Rate <1>	Interpolator Rate <0>	Spectral Inversion	Bypass the Third Half-Band Filter	FC	1
07	AD8320/AD8321 Gain Control Bits <7:0>								00	1
08	Frequency Tuning Word <7:0>								00	2
09	Frequency Tuning Word <15:8>								00	2
0A	Frequency Tuning Word <23:16>								00	2
0B	Frequency Tuning Word <31:24>								80	2
0C	Interpolator Rate <5>	Interpolator Rate <4>	Interpolator Rate <3>	Interpolator Rate <2>	Interpolator Rate <1>	Interpolator Rate <0>	Spectral Inversion	Bypass the Third Half-Band Filter	1E	2
0D	AD8320/AD8321 Gain Control Bits <7:0>								00	2
0E	Frequency Tuning Word <7:0>								Unset	3
0F	Frequency Tuning Word <15:8>								Unset	3
10	Frequency Tuning Word <23:16>								Unset	3
11	Frequency Tuning Word <31:24>								Unset	3
12	Interpolator Rate <5>	Interpolator Rate <4>	Interpolator Rate <3>	Interpolator Rate <2>	Interpolator Rate <1>	Interpolator Rate <0>	Spectral Inversion	Bypass the Third Half-Band Filter	Unset	3
13	AD8320/AD8321 Gain Control Bits <7:0>								00	3
14	Frequency Tuning Word <7:0>								Unset	4
15	Frequency Tuning Word <15:8>								Unset	4
16	Frequency Tuning Word <23:16>								Unset	4
17	Frequency Tuning Word <31:24>								Unset	4
18	Interpolator Rate <5>	Interpolator Rate <4>	Interpolator Rate <3>	Interpolator Rate <2>	Interpolator Rate <1>	Interpolator Rate <0>	Spectral Inversion	Bypass the Third Half-Band Filter	Unset	4
19	AD8320/AD8321 Gain Control Bits <7:0>								00	4

REGISTER BIT DEFINITIONS

Control Bits—Register Address 00h and 01h

SDO Active—Register Address 00h, Bit 7. Active high indicates serial port uses dedicated in/out lines. Default low configures serial port as single-line I/O.

LSB First—Register Address 00h, Bit 6. Active high indicates serial port access is LSB-to-MSB format. Default low indicates MSB-to-LSB format.

REFCLK Multiplier—Register Address 00h, Bits 5, 4, 3, 2, 1 form the reference clock multiplier. Valid entries range from 4–20 (decimal). Straight binary to decimal conversion is implemented. For example, to multiply the reference clock by 19 decimal, Program Register Address 00h, Bits 5–1, as 13h. Default value is 0A (hex).

Reserved Bit—Register Address 00h, Bit 0. This bit is reserved. Always set this bit to Logic 1 when writing to this register.

CIC Gain—Register Address 01h, Bit 7. The CIC GAIN bit multiplies the CIC filter output by 2. See the Cascaded Integrator Comb (CIC) Filter section for more details. Default value is 0 (inactive).

Continuous Mode—Register Address 01h, Bit 6 is the continuous mode configuration bit. Active high configures the AD9856 to accept continuous-mode timing on the TxENABLE input. A low configures the device for burst-mode timing. Default value is 0 (burst mode).

Full Sleep Mode—Register Address 01h, Bit 5. Active high full sleep mode bit. When activated, the AD9856 enters a full shutdown mode, consuming less than 2 mA after completing a shutdown sequence. Default value is 0 (awake).

Single-Tone Mode—Register Address 01h, Bit 4. Active high configures the AD9856 for single-tone applications. The AD9856 supplies a single-frequency output as determined by the frequency tuning word (FTW) selected by the active profile. In this mode, the 12 input data pins are ignored but should be tied high or low. Default value is 0 (inactive).

Bypass Inverse Sinc Filter—Register Address 01h, Bit 3. Active high configures the AD9856 to bypass the $\text{SIN}(x)/x$ compensation filter. Default value is 0 (inverse SINC filter enabled).

Bypass REFCLK Multiplier—Register Address 01h, Bit 2. Active high configures the AD9856 to bypass the REFCLK multiplier function. When active, effectively causes the REFCLK multiplier factor to be 1. Default value is 1 (REFCLK multiplier bypassed).

Input Format Select—Register Address 01h, Bits 1 and 0, form the input format mode bits.

10b = 12-bit mode

01b = 6-bit mode

00b = 3-bit mode

Default value is 10b (12-bit mode).

Profile 1 Registers—Active when PROFILE Inputs are 00b

Frequency Tuning Word (FTW)—The frequency tuning word for Profile 1 is formed via a concatenation of register addresses 05h, 04h, 03h, and 02h. Bit 7 of Register Address 05h is the most significant bit of the Profile 1 frequency tuning word. Bit 0 of Register Address 02h is the least significant bit of the Profile 1 frequency tuning word. The output frequency equation is given as: $f_{\text{OUT}} = (\text{FTW} \text{ SYSCLK})/2^{32}$.

Interpolation Rate—Register Address 06h, Bit 7 through Bit 2 form the Profile 1 CIC filter interpolation rate value. Allowed values range from 2 to 63 (decimal).

Spectral Inversion—Register Address 06h, Bit 1. Active high, Profile 1 spectral inversion bit. When active, inverted modulation is performed $[I \cos(\omega t) + Q \times \sin(\omega t)]$. The Default is inactive, Logic 0, noninverted modulation $[I \times \cos(\omega t) - Q \times \sin(\omega t)]$.

Bypass Half-Band Filter 3—Register Address 06h, Bit 0. Active high, causes the AD9856 to bypass the third half-band filter stage that precedes the CIC interpolation filter. Bypassing the third half-band filter negates the $2\times$ upsample inherent with this filter and reduces the overall interpolation rate of the half-band filter chain from $8\times$ to $4\times$. Default value is 0 (Half-Band 3 enabled).

AD8320/AD8321 Gain Control—Register Address 07h, Bit 7 through Bit 0 form the Profile 1 AD8320/AD8321 gain bits. The AD9856 dedicates three output pins, which directly interface to the AD8320/AD8321 cable driver amp. This allows direct control of the cable driver via the AD9856. See the **Error! Reference source not found.** section for more details. Bit 7 is the MSB, Bit 0 is the LSB. Default value is 00h.

Profile 2 Registers—Active when PROFILE Inputs are 01b
Profile 2 register functionality is identical to Profile 1, with the exception of the register addresses.

Profile 3 Registers—Active when PROFILE Inputs are 10b
Profile 3 register functionality is identical to Profile 1, with the exception of the register addresses.

Profile 4 Registers—Active when PROFILE Inputs are 11b
Profile 4 register functionality is identical to Profile 1, with the exception of the register addresses.

THEORY OF OPERATION

To gain a general understanding of the functionality of the AD9856, it is helpful to refer to Figure 23, a block diagram of the device architecture. The following is a general description of the device functionality. Later sections detail each of the data path building blocks.

MODULATION MODE OPERATION

The AD9856 accepts 12-bit data-words, which are strobed into the data assembler via an internal clock. The input, TxENABLE, serves as the valve that allows data to be accepted or ignored by the data assembler. The user has the option to feed the 12-bit data-words to the AD9856 as single 12-bit words, dual 6-bit words, or quad 3-bit words. This provides the user with the flexibility to use fewer interface pins, if desired. Furthermore, the incoming data is assumed to be complex in that alternating 12-bit words are regarded as the inphase (I) and quadrature (Q) components of a symbol.

The rate at which the 12-bit words are presented to the AD9856 is referred to as the input sample rate (f_{IN}). Note that f_{IN} is not the same as the baseband data rate provided by the user. Rather, the user's baseband data is required to be upsampled by at least a factor of two (2) before being applied to the AD9856 in order to minimize the frequency-dependent attenuation associated with the CIC filter stage (see the Cascaded Integrator Comb (CIC) Filter section).

The data assembler splits the incoming data-word pairs into separate I/Q data streams. The rate at which the I/Q data-word pairs appear at the output of the data assembler is referred to as the I/Q sample rate (f_{IQ}). Because two 12-bit input data-words are used to construct the individual I and Q data paths, the input sample rate is twice the I/Q sample rate (i.e., $f_{IN} = 2 \times f_{IQ}$).

Once through the data assembler, the I/Q data streams are fed through two half-band filters (Half-Band Filters 1 and 2). The combination of these two filters results in a factor of four (4) increase of the sample rate. Thus, at the output of Half-Band Filter 2, the sample rate is $4 \times f_{IQ}$. In addition to the sample rate increase, the half-band filters provide the low-pass filtering characteristic necessary to suppress the spectral images produced by the upsampling process. Further upsampling is available via an optional third half-band filter (Half-Band Filter 3). When selected, this provides an overall upsampling factor of eight (8). Thus, if Half-Band Filter 3 is selected, the sample rate at its output is $8 \times f_{IQ}$.

After passing through the half-band filter stages, the I/Q data streams are fed to a cascaded integrator comb (CIC) filter. This filter is configured as an interpolating filter, which allows further upsampling rates of any integer value between 2 and 63, inclusive. The CIC filter, like the half-bands, has a built-in low-pass characteristic. Again, this provides for suppression of the spectral images produced by the upsampling process.

The digital quadrature modulator stage following the CIC filters is used to frequency shift the baseband spectrum of the incoming data stream up to the desired carrier frequency (a process known as upconversion). The carrier frequency is controlled numerically by a direct digital synthesizer (DDS). The DDS uses its internal reference clock (SYSCLK) to generate the desired carrier frequency with a high degree of precision. The carrier is applied to the I and Q multipliers in quadrature fashion (90° phase offset) and summed to yield a data stream that is the modulated carrier. Note that the incoming data has been converted from an input sample rate of f_{IN} to an output sample rate of SYSCLK (see Figure 23).

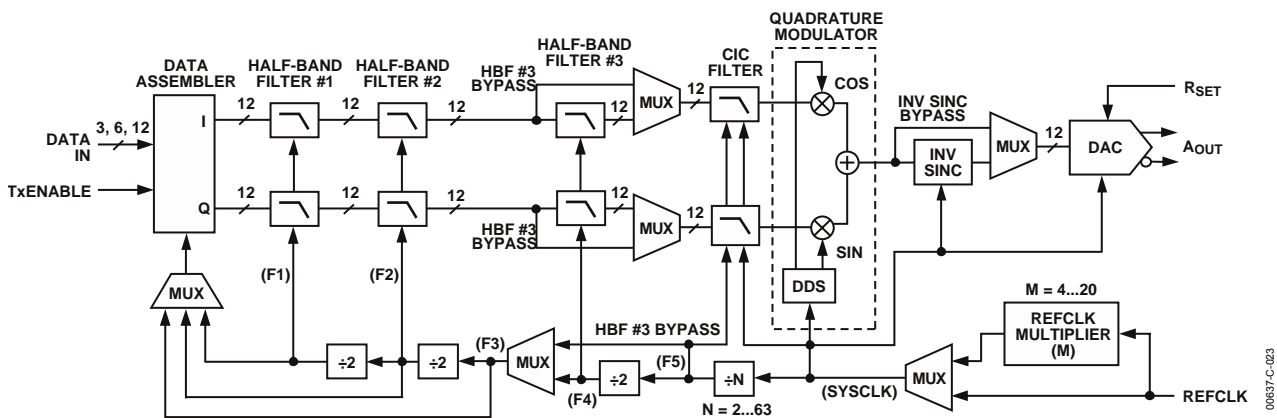

Figure 23. AD9856 Block Diagram

The sampled carrier is ultimately destined to serve as the input data to the digital-to-analog converter (DAC) integrated on the AD9856. The DAC output spectrum is distorted due to the intrinsic zero-order hold effect associated with DAC-generated signals. This distortion is deterministic, however, and follows the familiar $\text{SIN}(x)/x$ (or SINC) envelope. Because the SINC distortion is predictable, it is also correctable—therefore, the presence of the optional inverse SINC filter preceding the DAC. This is a FIR filter, which has a transfer function conforming to the inverse of the SINC response. Thus, when selected, it modifies the incoming data stream so that the SINC distortion, which would otherwise appear in the DAC output spectrum, is virtually eliminated.

As mentioned earlier, the output data is sampled at the rate of SYSCLK. Because the AD9856 is designed to operate at SYSCLK frequencies up to 200 MHz, there is the potential difficulty of trying to provide a stable input clock (REFCLK). Although stable, commercial high frequency oscillators tend to be cost prohibitive. To alleviate this problem, the AD9856 has a built-in programmable clock multiplier circuit. This allows the user to use a relatively low frequency (thus, less expensive) oscillator to generate the REFCLK signal. The low frequency REFCLK signal can then be multiplied in frequency by an integer factor between 4 and 20, inclusive, to become the SYSCLK signal.

Single-Tone Output Operation

The AD9856 can be configured for frequency synthesis applications by writing the single-tone bit true. In single-tone mode, the AD9856 disengages the modulator and preceding data path logic to output a spectrally pure, single-frequency sine wave. The AD9856 provides for a 32-bit frequency tuning word, which results in a tuning resolution of 0.046 Hz at a SYSCLK rate of 200 MHz.

When using the AD9856 as a frequency synthesizer, a general rule is to limit the fundamental output frequency to 40% of SYSCLK. This avoids generating aliases too close to the desired fundamental output frequency, thus minimizing the cost of filtering the aliases.

All applicable programming features of the AD9856 apply when configured in single-tone mode. These features include:

- Frequency hopping via the profile inputs and associated tuning word, which allows frequency shift keying (FSK) modulation.
- Ability to bypass the REFCLK multiplier, which results in lower phase noise and reduced output jitter.
- Ability to bypass the $\text{SIN}(x)/x$ compensation filter.
- Full power-down mode.

INPUT WORD RATE (F_w) vs. REFCLK RELATIONSHIP

There is a fundamental relationship between the input word rate (f_w) and the frequency of the clock that serves as the timing source for the AD9856 (REFCLK). The f_w is defined as the rate at which K-bit data-words ($K = 3, 6, \text{ or } 12$) are presented to the AD9856. However, the following factors affect this relationship:

- The interpolation rate of the CIC filter stage.
- Whether or not Half-Band Filter 3 is bypassed.
- The value of the REFCLK multiplier (if selected).
- Input word length.

This relationship can be summed as

$$\text{REFCLK} = (2^H N f_w) / M I$$

where H , N , I , and M are integers determined as follows:

- | | | |
|-----|---|--|
| H | = | 1: Half-Band Filter 3 bypassed
2: Half-Band Filter 3 enabled |
| M | = | 1: REFCLK multiplier bypassed
$4 \leq M \leq 20$: REFCLK multiplier enabled |
| I | = | 1: Full-word input format
2: Half-word input format
4: Quarter-Word input format |
| N | = | CIC interpolation rate ($2 \leq N \leq 63$) |

These conditions show that REFCLK and f_w have an integer ratio relationship. It is very important that users choose a value of REFCLK to ensure that this integer ratio relationship is maintained.

I/Q DATA SYNCHRONIZATION

As mentioned previously, the AD9856 accepts I/Q data pairs and a twos complement numbering system in three different word length modes. The full-word mode accepts 12-bit parallel I and Q data. The half-word mode accepts dual 6-bit I and Q data inputs to form a 12-bit word. The quarter-word mode accepts multiple 3-bit I and Q data inputs to form a 12-bit word. For all word length modes, the AD9856 assembles the data for signal processing into time-aligned, parallel, 12-bit I/Q pairs. In addition to the word length flexibility, the AD9856 has two input timing modes, burst or continuous, that are programmable via the serial port.

For burst-mode input timing, no external data clock needs to be provided, because the data is oversampled at the $D<11:0>$ pins using the system clock (SYSCLK). The TxENABLE pin is required to frame the data burst, because the rising edge of TxENABLE is used to synchronize the AD9856 to the input data rate. The AD9856 registers the input data at the approximate center of the data valid time. Thus, for larger CIC interpolation rates, more SYSCLK cycles are available to oversample the input data, maximizing clock jitter tolerances.

For continuous-mode input timing, the TxENABLE pin can be thought of as a data input clock running at half the input sample rate ($f_w/2$). In addition to synchronization, for continuous mode timing, the TxENABLE input indicates whether an I or Q input is being presented to the D<11:0> pins. It is intended that data is presented in alternating fashion such that I data is followed by Q data. Stated another way, the TxENABLE pin should maintain approximately a 50/50 duty cycle. As in burst mode, the rising edge of TxENABLE synchronizes the AD9856 to the input data rate and the data is registered at the approximate center of the data-valid time. The continuous operating mode can only be used in conjunction with the full-word input format.

Burst Mode Input Timing

Figure 24 through Figure 28 show the input timing relationship between TxENABLE and the 12-bit input data-word for all three input format modes when the AD9856 is configured for burst input timing. Also shown in these diagrams is the time-aligned, 12-bit parallel I/Q data as assembled by the AD9856.

Figure 24 shows the classic burst-mode timing, for full-word input mode, in which TxENABLE frames the input data stream. Note that sequential input of alternating I/Q data, starting with I data, is required.

The input sample rate for full-word mode, when the third half-band filter is engaged, is given by

$$f_{IN} = \text{SYSCLK}/4N$$

where N is the CIC interpolation rate.

The input sample rate for full-word mode, when the third half-band filter is not engaged is given by:

$$f_{IN} = \text{SYSCLK}/2N$$

where N is the CIC interpolation rate

Figure 25 shows an alternate timing method for TxENABLE when the AD9856 is configured in full-word, burst-mode operation. The benefit of this timing is that the AD9856 resynchronizes the input sampling logic when the rising edge of TxENABLE is detected. The low time on TxENABLE is limited to one input sample period and must be low during the Q data period. The maximum high time on TxENABLE is unlimited. Thus, unlimited high time on TxENABLE results in the timing diagram of Figure 24. See Figure 28 for the ramifications of violating the TxENABLE low time constraint when operating in burst mode.

Figure 26 shows the input timing for half-word mode, burst input timing operation.

In half-word mode, data is input on the D<11:6> inputs. The D<5:0> inputs are unused in this mode and should be tied to DGND or DVDD. The AD9856 expects the data to be input in the following manner: I<11:6>, I<5:0>, Q<11:6>, Q<5:0>. Data is twos complement; the sign bit is D<11> in the notation I<11:0>, Q<11:0>.

The input sample rate for half-word mode, when the third half-band filter is engaged, is given by

$$f_{IN} = \text{SYSCLK}/4N$$

where N is the CIC interpolation rate.

The input sample rate for half-word mode, when the third half-band filter is not engaged is given by:

$$f_{IN} = \text{SYSCLK}/2N$$

where N is the CIC interpolation rate.

Figure 27 shows the input timing for quarter-word, burst input timing operation.

In quarter-word mode, data is input on the D<11:9> inputs. The D<8:0> inputs are unused in this mode and should be tied to DGND or DVDD. The AD9856 expects the data to be input in the following manner: I<11:9>, I<8:6>, I<5:3>, I<2:0>, Q<11:9>, Q<8:6>, Q<5:3>, Q<2:0>. Data is twos complement; the sign bit is D<11> in the notation I<11:0>, Q<11:0>.

The input sample rate for quarter-word mode, when the third half-band filter is engaged, is given by:

$$f_{IN} = \text{SYSCLK}/N$$

where N is the CIC interpolation rate.

Note that Half-Band Filter 3 must be engaged when operating in quarter-word mode.

Figure 28 describes the end of burst timing and internal data assembly. Note that in burst-mode operation, if the TxENABLE input is low for more than one input sample period, numerical zeros are internally generated and passed to the data path logic for signal processing. This is not valid for continuous-mode operation, as is discussed later.

To ensure proper operation, the minimum time between falling and rising edges of TxENABLE is one input sample period.

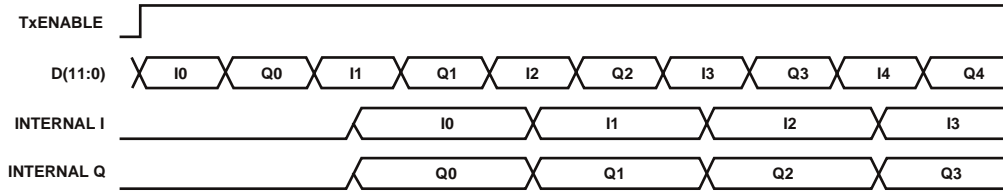

Figure 24. 12-Bit Input Mode, Classic Burst Timing

00637-C-024

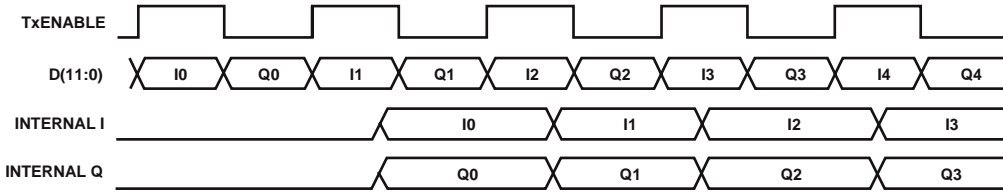

Figure 25. 12-Bit Input Mode, Alternate TxENABLE Timing

00637-C-025

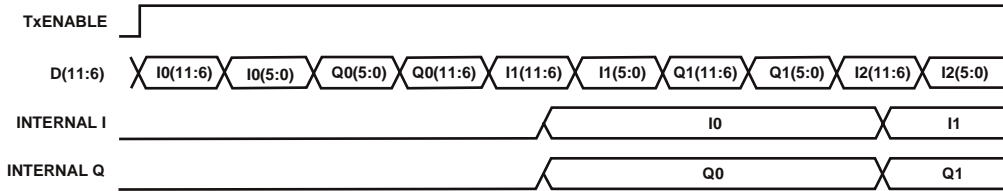

Figure 26. 6-Bit Input Mode, Burst Mode Timing

00637-C-026

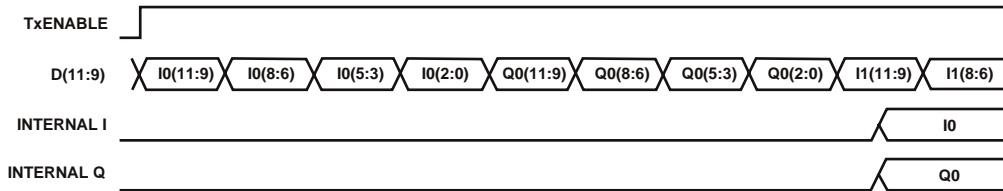

Figure 27. 3-Bit Input Mode, Burst Mode Timing

00637-C-027

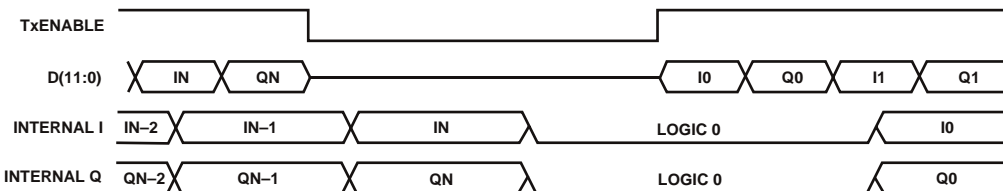

Figure 28. End of Burst Mode Input Timing

00637-C-028

Continuous Mode Input Timing

The AD9856 is configured for continuous mode input timing by writing the continuous mode bit true (Logic 1). The continuous mode bit is in register address 01h, Bit 6. The AD9856 must be configured for full-word input format when operating in continuous mode input timing. The input data rate equations described previously for full-word mode apply for continuous mode. Figure 25, which is the alternate burst mode timing diagram, is also the continuous mode input timing. Figure 29 and Figure 30 show what the internal data assembler presents to the signal processing logic when the TxENABLE input is held static for greater than one input sample period. Please note that the timing diagram shown in Figure 29 and Figure 30 detail INCORRECT timing relationships between TxENABLE and data. They are only presented to indicate that the AD9856 resynchronizes properly after detecting a rising

edge of TxENABLE. Also note that the significant difference between burst and continuous mode operation is that in addition to synchronizing the data, TxENABLE is used to indicate whether an I or Q input is being sampled.

Do not engage continuous mode simultaneously with the REFCLK multiplier function. This corrupts the CIC interpolating filter, forcing unrecoverable mathematical overflow that can only be resolved by issuing a RESET command. The problem is due to the PLL failing to be locked to the reference clock while nonzero data is being clocked into the interpolation stages from the data inputs. The recommended sequence is to first engage the REFCLK multiplier function (allowing at least 1 ms for loop stabilization) and then engage continuous mode via software.

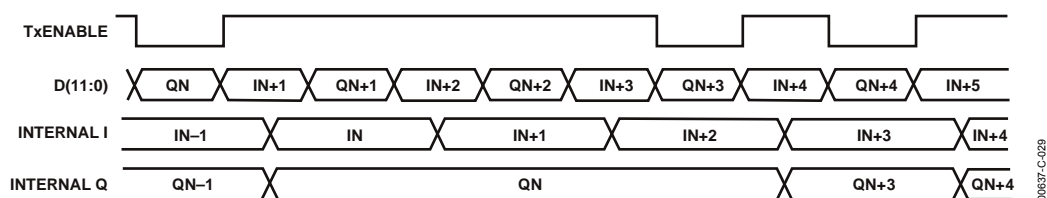

Figure 29. Continuous Mode Input Timing—TxENABLE Static High (for illustrative purposes only)

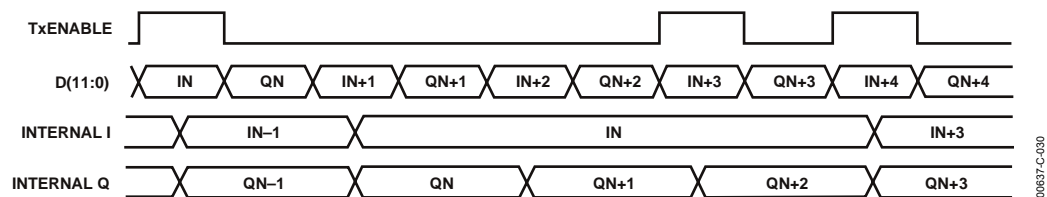

Figure 30. Continuous Mode Input Timing—TxENABLE Static Low (for illustrative purposes only)

HALF-BAND FILTERS (HBFS)

Before presenting a detailed description of the HBFS, recall that the input data stream is representative of complex data; i.e., two input samples are required to produce one I/Q data pair. The I/Q sample rate is one-half the input data rate. The I/Q sample rate (the rate at which I or Q samples are presented to the input of the first half-band filter) is referred to as f_{IQ} . Because the AD9856 is a quadrature modulator, f_{IQ} represents the baseband of the internal I/Q sample pairs. It should be emphasized here that f_{IQ} is not the same as the baseband of the user's symbol rate data, which must be upsampled before presentation to the AD9856 (as is explained later). The I/Q sample rate (f_{IQ}) puts a limit on the minimum bandwidth necessary to transmit the f_{IQ} spectrum. This is the familiar Nyquist limit and is equal to one half f_{IQ} , which is referred to as f_{NYQ} .

HBF 1 is a 47-tap filter that provides a factor-of-two increase in the sampling rate. HBF 2 is a 15-tap filter offering an additional factor-of-two increase in the sampling rate. Together, HBF 1 and HBF 2 provide a factor-of-four increase in the sampling rate ($4 \times f_{IQ}$ or $8 \times f_{NYQ}$). Their combined insertion loss is a mere 0.01 dB, so virtually no loss of signal level occurs through the first two HBFS. HBF 3 is an 11-tap filter and, if selected, increases the sampling rate by an additional factor of two. Thus, the output sample rate of HBF 3 is $8 \times f_{IQ}$ or $16 \times f_{NYQ}$. HBF 3 exhibits 0.03 dB of signal-level loss. As such, the loss in signal level through all three HBFS is only 0.04 dB and may be ignored for all practical purposes.

In relation to phase response, all three HBFS are linear phase filters. As such, virtually no phase distortion is introduced within the pass band of the filters. This is an important feature as phase distortion is generally intolerable in a data transmission system.

In addition to knowledge of the insertion loss and phase response of the HBFS, some knowledge of the frequency response of the HBFS is useful as well. The combined frequency response of HBF 1 and 2 is shown in Figure 31 and Figure 32.

The usable bandwidth of the filter chain puts a limit on the maximum data rate that can be propagated through the device. A look at the pass-band detail of the HBF 1 and HBF 2 response indicates that to maintain an amplitude error of no more than 1 dB, users are restricted to signals having a bandwidth of no more than about 90% of f_{NYQ} . To keep the bandwidth of the data in the flat portion of the filter pass band, users must oversample the baseband data by at least a factor of two prior to presenting it to the AD9856. Without over-sampling, the Nyquist bandwidth of the baseband data corresponds to the f_{NYQ} . As such, the upper end of the data bandwidth suffers 6 dB or more of attenuation due to the frequency response of HBF 1 and HBF 2. Furthermore, if the baseband data applied to the AD9856 has been pulse shaped, there is an additional concern. Typically, pulse shaping is applied to the baseband data via a filter having

a raised cosine response. In such cases, an α value is used to modify the bandwidth of the data where the value of α is such that $0 \leq \alpha \leq 1$. A value of 0 causes the data bandwidth to correspond to the Nyquist bandwidth. A value of 1 causes the data bandwidth to be extended to twice the Nyquist bandwidth. Thus, with $2\times$ oversampling of the baseband data and $\alpha = 1$, the Nyquist bandwidth of the data corresponds with the I/Q Nyquist bandwidth. As stated earlier, this results in problems near the upper edge of the data bandwidth due to the frequency response of HBF 1 and 2.

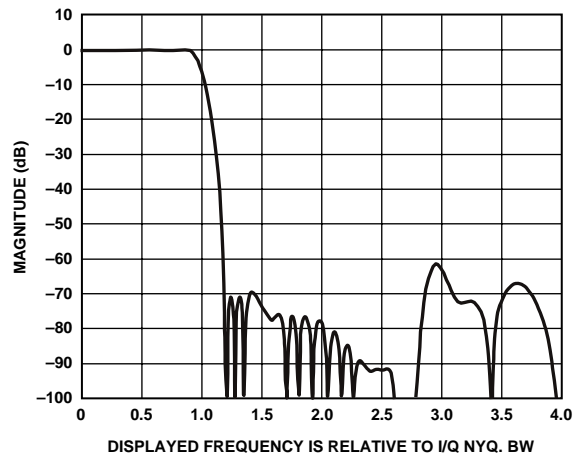

Figure 31. Half-Band 1 and 2 Frequency Response

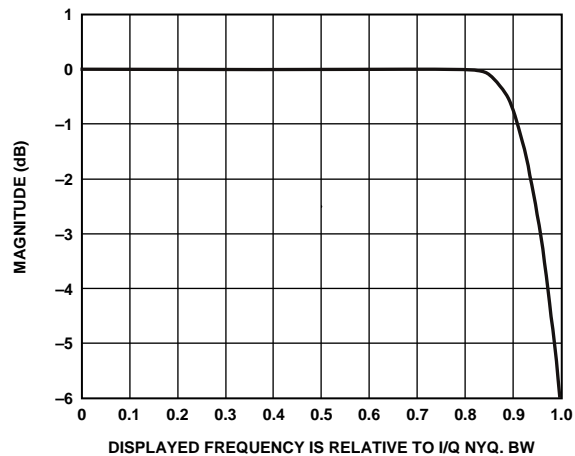

Figure 32. Pass-Band Detail: Combined Frequency Response of HBF 1 and 2

To reiterate, the user must *oversample* the baseband data by at least a *factor of two* (2). In addition, there is a further restriction on pulse shaping—the maximum value of α that can be implemented is 0.8. This is because the data bandwidth becomes $1/2(1 + \alpha) f_{NYQ} = 0.9 f_{NYQ}$, which puts the data bandwidth at the extreme edge of the flat portion of the filter response. If a particular application requires an α value between 0.8 and 1, then the user must *oversample* the baseband data by at least a *factor of four* (4).

In applications requiring both a low data rate and a high output sample rate, a third HBF is available (HBF 3). Selecting HBF 3 offers an upsampling ratio of eight (8) instead of four (4). The combined frequency response of HBF 1, 2, and 3 is shown in Figure 33 and Figure 34. Comparing the pass-band detail of HBF 1 and 2 with the pass-band detail of HBF 1, 2, and 3, HBF 3 has virtually no impact on frequency response from 0 to 1 (where 1 corresponds to f_{NYQ}).

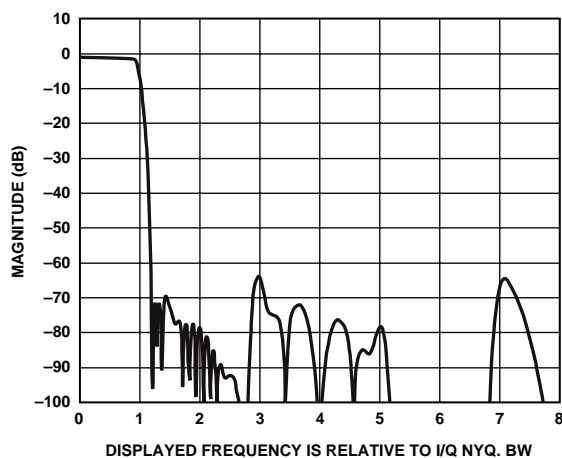

Figure 33. Half-Band 1, 2, and 3 Frequency Response

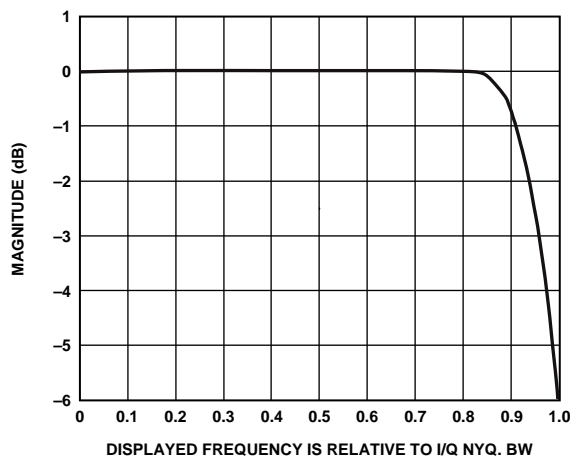

Figure 34. Pass-Band Detail: Combined Frequency Response of HBF 1 to 3

CASCADED INTEGRATOR COMB (CIC) FILTER

A CIC filter is unlike a typical FIR filter in that it offers the flexibility to handle differing input and output sample rates (only in integer ratios, however). In the purest sense, a CIC filter can provide either an increase or a decrease in the sample rate at the output relative to the input, depending on the architecture. If the integration stage precedes the comb stage, the CIC filter provides sample rate reduction (decimation). When the comb stage precedes the integrator stage the CIC filter provides an increase in sample rate (interpolation). In the AD9856, the CIC filter is configured as an interpolator—a programmable interpolator—and provides a sample rate increase, R , such that $2 \leq R \leq 63$.

In addition to the ability to provide a change in sample rate between input and output, a CIC filter also has an intrinsic low-pass frequency response characteristic. The frequency response of a CIC filter depends on:

- The rate change ratio, R .
- The order of the filter, N .
- The number of unit delays per stage, M .

The system function, $H(z)$, of a CIC filter is given by:

$$H(z) = \left(\frac{1 - z^{-RM}}{1 - z^{-1}} \right)^N = \left(\sum_{\kappa=0}^{RM-1} z^{-\kappa} \right)^N$$

The form on the far right has the advantage of providing a result for $z = 1$ (corresponding to zero frequency or dc). The alternate form yields an indeterminate form (0/0) for $z = 1$, but is otherwise identical. The only variable parameter for the AD9856 CIC filter is R . M and N are fixed at 1 and 4, respectively. Thus, the CIC system function for the AD9856 simplifies to:

$$H(z) = \left(\frac{1 - z^{-R}}{1 - z^{-1}} \right)^4 = \left(\sum_{\kappa=0}^{R-1} z^{-\kappa} \right)^4$$

The transfer function is given by:

$$H(f) = \left(\frac{1 - e^{-j(2\pi fR)}}{1 - e^{-j(2\pi f)}} \right)^4 = \left(\sum_{\kappa=0}^{R-1} e^{-j(2\pi f\kappa)} \right)^4$$

The frequency response in this form is such that f is scaled to the output sample rate of the CIC filter. That is, $f = 1$ corresponds to the frequency of the output sample rate of the CIC filter. $H(f/R)$ yields the frequency response with respect to the input sample of the CIC filter. Figure 35 to Figure 44 show the CIC frequency response and pass-band detail for $R = 2$ and $R = 63$, with HBF 3 bypassed. Figure 45 to Figure 50 are similar, but HBF 3 is selected. Note the flatter pass-band response when HBF 3 is employed.

As with HBFs, consideration must be given to the frequency-dependent attenuation that the CIC filter introduces over the frequency range of the data to be transmitted. Note that the CIC frequency response figures have f_{NYQ} as their reference frequency; i.e., unity (1) on the frequency scale corresponds to f_{NYQ} . If the incoming data that is applied to the AD9856 is oversampled by a factor of 2 (as required), then the Nyquist bandwidth of the applied data is one-half f_{NYQ} on the CIC frequency response figures. A look at the 0.5 point on the pass-band detail figures reveals a worst-case attenuation of about 0.25 dB (HBF 3 bypassed, $R = 63$). This, of course, assumes pulse-shaped data with $\alpha = 0$ (minimum bandwidth scenario). When a value of $\alpha = 1$ is used, the bandwidth of the data corresponds to f_{NYQ} (the point 1.0 on the CIC frequency scale). Thus, the worst-case attenuation for $\alpha = 1$ is about 0.9 dB.

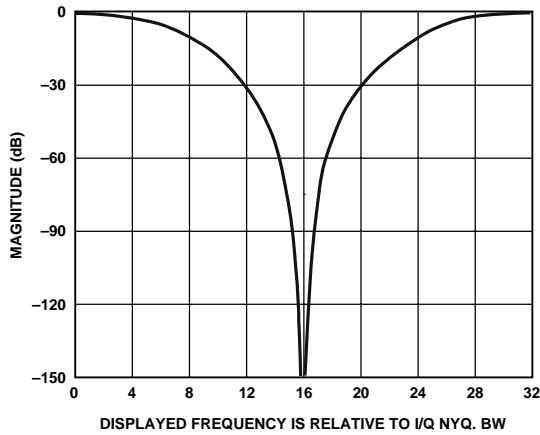

00637-C-036

Figure 35. CIC Filter Frequency Response ($R = 2$, HFB 3 Bypassed)

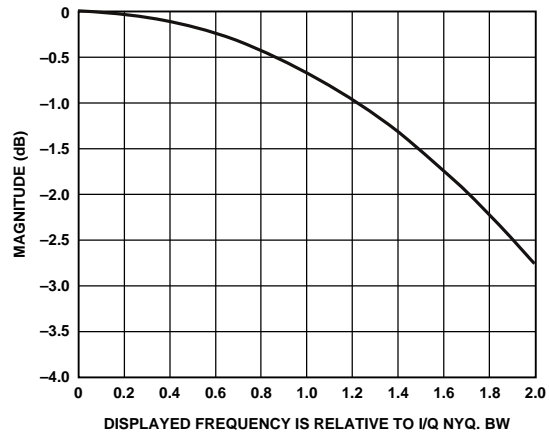

00637-C-037

Figure 36. Pass-Band Detail ($R = 2$, HFB 3 Bypassed)

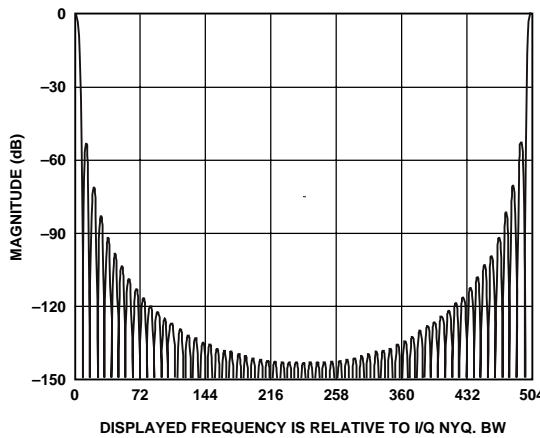

00637-C-036

Figure 37. CIC Filter Frequency Response ($R = 63$, HFB 3 Bypassed)

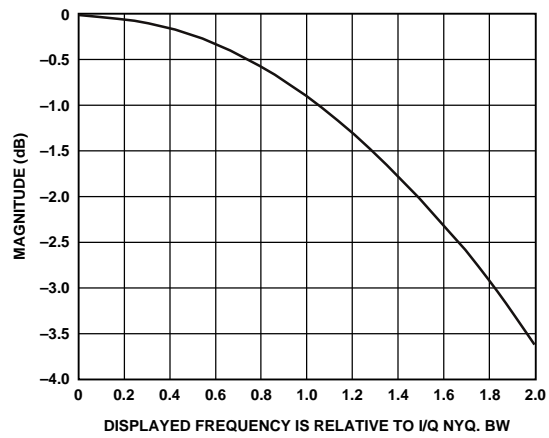

00637-C-038

Figure 38. Pass-Band Detail ($R = 63$, HFB 3 Bypassed)

The degree of the impact of the attenuation introduced by the CIC filter over the Nyquist bandwidth of the data is application specific. The user must decide how much attenuation is acceptable. If less attenuation is desired, then additional oversampling of the baseband data must be employed. Alternatively, the user can precompensate the baseband data before presenting it to the AD9856. That is, if the data is precompensated through a filter that has a frequency response characteristic, which is the inverse of the CIC filter response, then the overall system response can be nearly perfectly flattened over the bandwidth of the data.

Another issue to consider with the CIC filters is insertion loss. Unfortunately, CIC insertion loss is not fixed, but is a function of R , M , and N . Because M , and N are fixed for the AD9856, the CIC insertion loss is a function of R only.

Interpolation rates that are an integer power-of-2 result in no insertion loss. However, all noninteger power-of-2 interpolation rates result in a specific amount of insertion loss.

To help overcome the insertion loss problem, the AD9856 provides the user a means to boost the gain through the CIC stage by a factor of 2 (via the CIC Gain bit—see the Serial Control Bus Register section). The reason for this feature is to allow the user to take advantage of the full dynamic range of the DAC, thus maximizing the signal-to-noise ratio (SNR) at the output of the DAC stage. It is best to operate the DAC over its full-scale range in order to minimize the inherent quantization effects associated with a DAC. Any significant loss through the CIC stage is reflected at the DAC output as a reduction in SNR. The degradation in SNR can be overcome by boosting the CIC output level. Table 6 tabulates insertion loss as a function of R . The values are provided in linear and decibel form, both with and without the factor-of-2 gain employed.

A word of caution: When the CIC Gain bit is active, ensure that the data supplied to the AD9856 is scaled down to yield an overall gain of unity (1) through the CIC filter stage. Gains in excess of unity are likely to cause overflow errors in the data path, compromising the validity of the analog output signal.

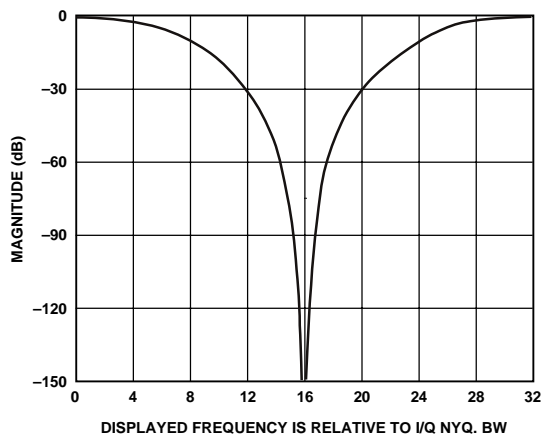

Figure 39. CIC Filter Frequency Response (R = 2, HBF 3 Selected)

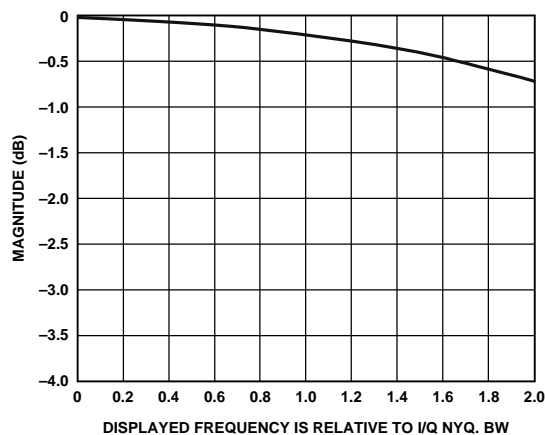

Figure 40. Pass-Band Detail (R = 2, HBF 3 Selected)

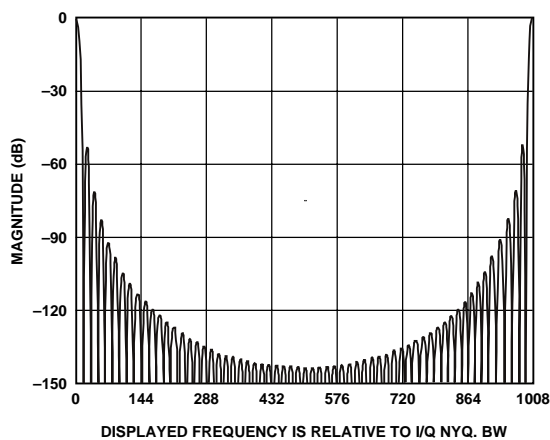

Figure 41. CIC Filter Frequency Response (R = 63, HBF 3 Active)

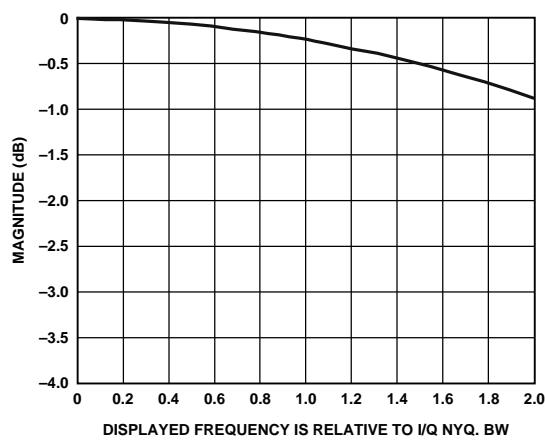

Figure 42. Pass-Band Detail (R = 63, HBF 3 Active)

DIGITAL QUADRATURE MODULATOR

Following the CIC filter stage the I and Q data (which have been processed independently up to this point) are mixed in the modulator stage to produce a digital modulated carrier. The carrier frequency is selected by programming the direct digital synthesizer (see the Direct Digital Synthesizer Function section) with the appropriate 32-bit tuning word via the AD9856 control registers. The DDS simultaneously generates a digital (sampled) sine and cosine wave at the programmed carrier frequency. The digital sine and cosine data is multiplied by the Q and I data, respectively, to create the quadrature components of the original data upconverted to the carrier frequency. The quadrature components are digitally summed and passed on to the subsequent stages.

The key point is that the modulation is done digitally, which eliminates the phase and gain imbalance and crosstalk issues typically associated with analog modulators. Note that the modulated signal is actually a number stream sampled at the rate of SYSCLK, which is the same rate at which the DAC is clocked (see Figure 23).

Note that the architecture of the quadrature modulator results in a 3 dB loss of signal level. To visualize this, assume that both the I data and Q data are fixed at the maximum possible digital value, x . Then the output of the modulator, y , is:

$$y = x \times \cos(\omega) + x \times \sin(\omega) = x \times [\cos(\omega) + \sin(\omega)]$$

From this equation, y assumes a maximum value of $x\sqrt{2}$ (a gain of 3 dB). However, if the same number of bits were used to represent the y values, as is used to represent the x values, an overflow would occur. To prevent this, an effective divide-by-two is implemented on the y values, which reduces the maximum value of y by a factor of two. Because division by two results in a 6 dB loss, the modulator yields an overall loss of 3 dB (3 dB – 6 dB = –3 dB, or 3 dB of loss).

Table 6. CIC Interpolation Filter Insertion Loss Table

Interpolation Rate	Default Gain		2 × Gain	
	(Linear)	(dB)	(Linear)	(dB)
2	1.0000	0.000	2.0000	6.021
3	0.8438	-1.476	1.6875	4.545
4	1.0000	0.000	2.0000	6.021
5	0.9766	-0.206	1.9531	5.815
6	0.8438	-1.476	1.6875	4.545
7	0.6699	-3.480	1.3398	2.541
8	1.0000	0.000	2.0000	6.021
9	0.7119	-2.951	1.4238	3.069
10	0.9766	-0.206	1.9531	5.815
11	0.6499	-3.743	1.2998	2.278
12	0.8438	-1.476	1.6875	4.545
13	0.5364	-5.411	1.0728	0.610
14	0.6699	-3.480	1.3398	2.541
15	0.8240	-1.682	1.6479	4.339
16	1.0000	0.000	2.0000	6.021
17	0.5997	-4.441	1.1995	1.580
18	0.7119	-2.951	1.4238	3.069
19	0.8373	-1.543	1.6746	4.478
20	0.9766	-0.206	1.9531	5.815
21	0.5652	-4.955	1.1305	1.065
22	0.6499	-3.743	1.2998	2.278
23	0.7426	-2.585	1.4852	3.436
24	0.8438	-1.476	1.6875	4.545
25	0.9537	-0.412	1.9073	5.609
26	0.5364	-5.411	1.0728	0.610
27	0.6007	-4.427	1.2014	1.593
28	0.6699	-3.480	1.3398	2.541
29	0.7443	-2.565	1.4886	3.455
30	0.8240	-1.682	1.6479	4.339
31	0.9091	-0.827	1.8183	5.193
32	1.0000	0.000	2.0000	6.021
33	0.5484	-5.219	1.0967	0.802
34	0.5997	-4.441	1.1995	1.580
35	0.6542	-3.686	1.3084	2.335
36	0.7119	-2.951	1.4238	3.069
37	0.7729	-2.237	1.5458	3.783
38	0.8373	-1.543	1.6746	4.478
39	0.9051	-0.866	1.8103	5.155
40	0.9766	-0.206	1.9531	5.815
41	0.5258	-5.583	1.0517	0.437
42	0.5652	-4.955	1.1305	1.065
43	0.6066	-4.342	1.2132	1.679
44	0.6499	-3.743	1.2998	2.278
45	0.6952	-3.157	1.3905	2.863
46	0.7426	-2.585	1.4852	3.436
47	0.7921	-2.024	1.5842	3.996
48	0.8438	-1.476	1.6875	4.545
49	0.8976	-0.938	1.7952	5.082

Interpolation Rate	Default Gain		2 × Gain	
	(Linear)	(dB)	(Linear)	(dB)
50	0.9537	-0.412	1.9073	5.609
51	0.5060	-5.917	1.0120	0.104
52	0.5364	-5.411	1.0728	0.610
53	0.5679	-4.914	1.1358	1.106
54	0.6007	-4.427	1.2014	1.593
55	0.6347	-3.949	1.2693	2.072
56	0.6699	-3.480	1.3398	2.541
57	0.7065	-3.018	1.4129	3.002
58	0.7443	-2.565	1.4886	3.455
59	0.7835	-2.120	1.5669	3.901
60	0.8240	-1.682	1.6479	4.339
61	0.8659	-1.251	1.7317	4.770
62	0.9091	-0.827	1.8183	5.193
63	0.9539	-0.410	1.9077	5.610

INVERSE SINC FILTER (ISF)

The AD9856 is almost entirely a digital device. The input signal is made up of a time series of digital data-words. These data-words propagate through the device as numbers. Ultimately, this number stream must be converted to an analog signal. To this end, the AD9856 incorporates an integrated DAC. The output waveform of the DAC is the familiar staircase pattern typical of a signal that is sampled and quantized. The staircase pattern is a result of the finite time that the DAC holds a quantized level until the next sampling instant. This is known as a zero-order hold function. The spectrum of the zero-order hold function is the $\text{SIN}(x)/x$, or SINC, envelope.

The series of digital data-words presented at the input of the DAC represent an impulse stream. It is the spectrum of this impulse stream, which is the desired output signal. Due to the zero-order hold effect of the DAC, however, the output spectrum is the product of the zero-order hold spectrum (the SINC envelope) and the Fourier transform of the impulse stream. Thus, there is an intrinsic distortion in the output spectrum, which follows the SINC response.

The SINC response is deterministic and totally predictable. Thus, it is possible to predistort the input data stream in a manner that compensates for the SINC envelope distortion. This can be accomplished by means of an ISF. The ISF incorporated on the AD9856 is a 17-tap, linear phase FIR filter. Its frequency response characteristic is the inverse of the SINC envelope. Data sent through the ISF is altered to correct for the SINC envelope distortion.

Note, however, that the ISF is sampled at the same rate as the DAC. Thus, the effective range of the SINC envelope compensation only extends to the Nyquist frequency (1/2 of the DAC sample rate).

Figure 43 shows the effectiveness of the ISF in correcting for the SINC distortion. The plot includes a graph of the SINC envelope, the ISF response and the SYSTEM response (which is the product of the SINC and ISF responses). Note that the ISF exhibits an insertion loss of 3.1 dB. Thus, signal levels at the output of the AD9856 with the ISF bypassed are 3.1 dB higher than with the ISF engaged. For modulated output signals, however, which have a relatively wide bandwidth, the benefits of the SINC compensation usually outweigh the 3 dB loss in output level. The decision of whether to use the ISF is an application specific system design issue.

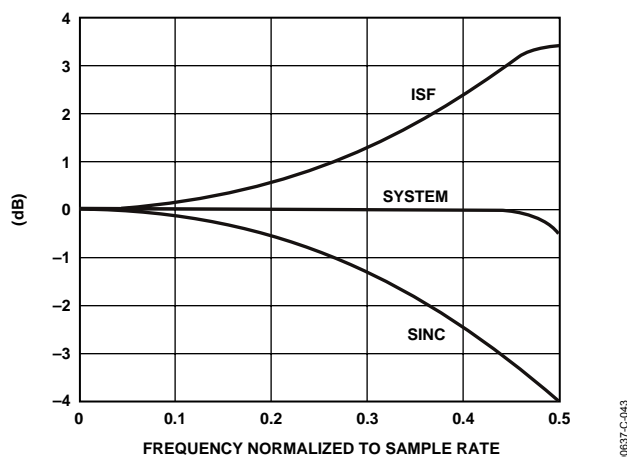

Figure 43. Inverse SINC Filter Response

DIRECT DIGITAL SYNTHESIZER FUNCTION

The direct digital synthesizer (DDS) block generates the sine/cosine carrier reference signals that are digitally modulated by the I/Q data paths. The DDS function is frequency tuned via the serial control port with a 32-bit tuning word. This allows the AD9856's output carrier frequency to be very precisely tuned while still providing output frequency agility.

The equation relating output frequency of the AD9856 digital modulator to the frequency tuning word (FTWORD) and the system clock (SYSCLK) is given as:

$$A_{OUT} = (FTWORD \times SYSCLK) / 2^{32}$$

where A_{OUT} and $SYSCLK$ frequencies are in Hz and $FTWORD$ is a decimal number from 0 to 4,294,967,296 (2^{31}).

For example, find the $FTWORD$ for $A_{OUT} = 41$ MHz and $SYSCLK = 122.88$ MHz.

If $A_{OUT} = 41$ MHz and $SYSCLK = 122.88$ MHz, then:

$$FTWORD = 556AAAAB \text{ hex}$$

Loading 556AAAABh into control bus registers 02h–05h (for Profile 1) programs the AD9856 for $A_{OUT} = 41$ MHz, given a $SYSCLK$ frequency of 122.88 MHz.

A *Technical Tutorial on Digital Signal Synthesis* is available on the Analog Devices website at: http://www.analog.com/UploadedFiles/Tutorials/450968421DDS_Tutorial_rev12-2-99.pdf

The tutorial provides basic applications information for a variety of digital synthesis implementations, as well as a detailed explanation of aliases.

D/A CONVERTER

A 12-bit digital-to-analog converter (DAC) is used to convert the digitally processed waveform into an analog signal. The worst-case spurious signals due to the DAC are the harmonics of the fundamental signal and their aliases (see the AD9851 Complete-DDS data sheet for details about aliased images). The wideband 12-bit DAC in the AD9856 maintains spurious-free dynamic range (SFDR) performance of -60 dBc up to $A_{OUT} = 42$ MHz and -55 dBc up to $A_{OUT} = 65$ MHz.

The conversion process produces aliased components of the fundamental signal at $n \times SYSCLK \pm F_{CARRIER}$ ($n = 1, 2, 3$). These are typically filtered with an external RLC filter at the DAC output. It is important for this analog filter to have a sufficiently flat gain and linear phase response across the bandwidth of interest to avoid modulation impairments. An inexpensive seventh-order elliptical low-pass filter is sufficient to suppress the aliased components for HFC network applications.

The AD9856 provides true and complement current outputs on pins 30 and 29, respectively. The full-scale output current is set by the R_{SET} resistor at Pin 25. The value of R_{SET} for a particular I_{OUT} is determined by

$$R_{SET} = 39.936 / I_{OUT}$$

For example, if a full-scale output current of 20 mA is desired, then $R_{SET} = (39.936 / 0.02)$, or approximately 2 k Ω . Every doubling of the R_{SET} value halves the output current. Maximum output current is specified as 20 mA.

The full-scale output current range of the AD9856 is 5 mA to 20 mA. Full-scale output currents outside of this range degrade SFDR performance. SFDR is also slightly affected by output matching, that is, the two outputs should be terminated equally for best SFDR performance.

The output load should be located as close as possible to the AD9856 package to minimize stray capacitance and inductance. The load may be a simple resistor to ground, an op amp current-to-voltage converter, or a transformer-coupled circuit. It is best not to attempt to directly drive highly reactive loads (such as an LC filter). Driving an LC filter without a transformer requires that the filter be doubly terminated for best performance, that is, the filter input and output should both be resistively terminated with the appropriate values. The parallel combination of the two terminations determines the

AD9856

load that the AD9856 sees for signals within the filter pass band. For example, a 50 Ω terminated input/output low-pass filter looks like a 25 Ω load to the AD9856.

The output compliance voltage of the AD9856 is -0.5 V to $+1.5$ V. Any signal developed at the DAC output should not exceed $+1.5$ V, otherwise, signal distortion results. Furthermore, the signal may extend below ground as much as 0.5 V without damage or signal distortion. The use of a transformer with a grounded center tap for common-mode rejection results in signals at the AD9856 DAC output pins that are symmetrical about ground.

As previously mentioned, by differentially combining the two signals the user can provide some degree of common-mode signal rejection. A differential combiner might consist of a transformer or an op amp. The object is to combine or amplify only the difference between two signals and to reject any common, usually undesirable, characteristic, such as 60 Hz hum or clock feedthrough that is equally present on both input signals. The AD9856 true and complement outputs can be differentially combined using a broadband 1:1 transformer with a grounded, center-tapped primary to perform differential combining of the two DAC outputs.

REFERENCE CLOCK MULTIPLIER

Because the AD9856 is a DDS-based modulator, a relatively high frequency system clock is required. For DDS applications, the carrier is typically limited to about 40% of SYSCLK. For a 65 MHz carrier, the system clock required is above 160 MHz. To avoid the cost associated with these high frequency references and the noise coupling issues associated with operating a high frequency clock on a PC board, the AD9856 provides an on-chip programmable clock multiplier (REFCLK multiplier). The available clock multiplier range is from $4\times$ to $20\times$, in integer steps. With the REFCLK multiplier enabled, the input reference clock required for the AD9856 can be kept in the 10 MHz to 50 MHz range for 200 MHz system operation, which results in cost and system implementation savings. The REFCLK multiplier function maintains clock integrity as evidenced by the AD9856's system phase noise characteristics of -105 dBc/Hz ($A_{OUT} = 40$ MHz, REFCLK multiplier = 6, Offset = 1 kHz) and virtually no clock related spuri in the output spectrum. External loop filter components consisting of a series resistor (1.3 k Ω) and capacitor (0.01 μ F) provide the compensation zero for the REFCLK multiplier PLL loop. The overall loop performance has been optimized for these component values.

THROUGHPUT AND LATENCY

Data latency through the AD9856 is easiest to describe in terms of SYSCLK clock cycles. Latency is a function of the AD9856 configuration primarily affected by the CIC interpolation rate and whether the third half-band filter is engaged.

When the third half-band filter is engaged, the AD9856 latency is given by $126N + 37$ SYSCLK clock cycles, where N is the CIC interpolation rate.

If the AD9856 is configured to bypass the third half-band filter, the latency is given by $63N + 37$ SYSCLK clock cycles.

These equations should be considered estimates, as observed latency may be data dependent. The latency was calculated using the linear delay model for the FIR filters.

In single-tone mode, frequency hopping is accomplished via changing the PROFILE input pins. The time required to switch from one frequency to another is < 50 SYSCLK cycles with the inverse SINC filter engaged. With the inverse SINC filter bypassed, the latency drops to < 35 SYSCLK cycles.

CONTROL INTERFACE

The flexible AD9856 synchronous serial communications port allows easy interface to many industry standard microcontrollers and microprocessors. The serial I/O is compatible with most synchronous transfer formats, including the Motorola 6905/11 SPI[®] and Intel[®] 8051 SSR protocols.

The interface allows read/write access to all registers that configure the AD9856. Single or multiple byte transfers are supported, as well as MSB first or LSB first transfer formats. The AD9856's serial interface port can be configured as a single-pin I/O (SDIO) or two unidirectional pins for input/output (SDIO/SDO).

GENERAL OPERATION OF THE SERIAL INTERFACE

There are two phases to a communication cycle with the AD9856. Phase 1 is the instruction cycle, which is the writing of an instruction byte into the AD9856, coincident with the first eight SCLK rising edges. The instruction byte provides the AD9856 serial port controller with information regarding the data transfer cycle, which is Phase 2 of the communication cycle. The Phase 1 instruction byte defines whether the upcoming data transfer is read or write, the number of bytes in the data transfer (1 to 4), and the starting register address for the first byte of the data transfer.

The first eight SCLK rising edges of each communication cycle are used to write the instruction byte into the AD9856. The remaining SCLK edges are for Phase 2 of the communication cycle. Phase 2 is the actual data transfer between the AD9856 and the system controller. Phase 2 of the communication cycle is a transfer of 1, 2, 3, or 4 data bytes as determined by the instruction byte. Normally, using one communication cycle in a multibyte transfer is the preferred method. However, single-byte communication cycles are useful to reduce CPU overhead when register access requires one byte only. Examples of this may be to write the AD9856 SLEEP bit, or an AD8320/AD8321 gain control byte.

At the completion of any communication cycle, the AD9856 serial port controller expects the next eight rising SCLK edges to be the instruction byte of the next communication cycle.

All data input to the AD9856 is registered on the rising edge of SCLK. All data is driven out of the AD9856 on the falling edge of SCLK. Figure 44 through Figure 47 show the general operation of the AD9856 serial port.

INSTRUCTION BYTE

The instruction byte contains the following information as shown in Table 7.

Table 7. Instruction Byte Information

MSB	D6	D5	D4	D3	D2	D1	LSB
R/W	N1	N0	A4	A3	A2	A1	A0

R/W—Bit 7 determines whether a read or write data transfer occurs after the instruction byte write. Logic high indicates a read operation. Logic zero indicates a write operation.

N1, N0—Bits 6 and 5 of the instruction byte determine the number of bytes to be transferred during the data transfer cycle of the communications cycle. Table 8 shows the decode bits.

Table 8. N1, N0 Decode Bits

N1	N0	Description
0	0	Transfer 1 byte
0	1	Transfer 2 bytes
1	0	Transfer 3 bytes
1	1	Transfer 4 bytes

A4, A3, A2, A1, A0—Bits 4, 3, 2, 1, 0 of the instruction byte determine which register is accessed during the data transfer portion of the communications cycle. For multibyte transfers, this address is the starting byte address. The remaining register addresses are generated by the AD9856.

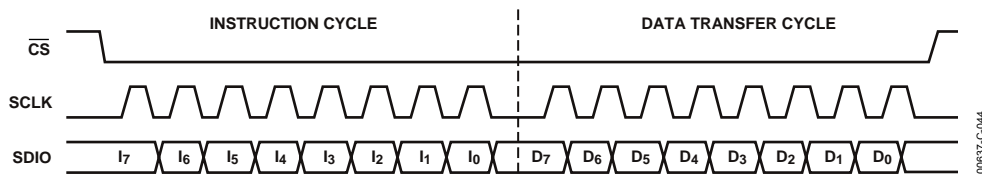

Figure 44. Serial Port Writing Timing—Clock Stall Low

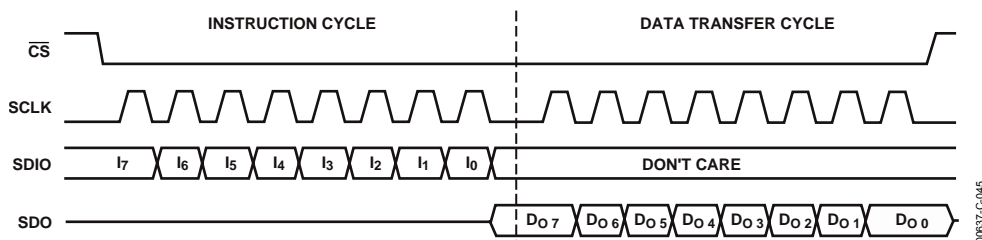

Figure 45. Three-Wire Serial Port Read Timing—Clock Stall Low

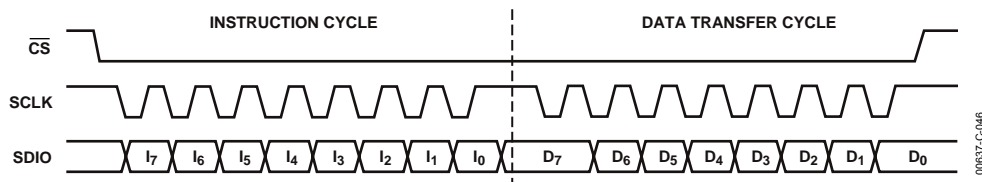

Figure 46. Serial Port Write Timing—Clock Stall High

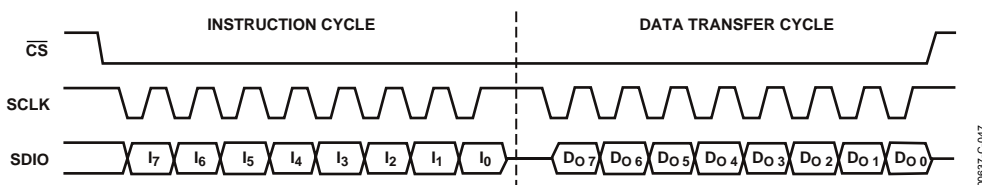

Figure 47. Two-Wire Serial Port Read Timing—Clock Stall High

SERIAL INTERFACE PORT PIN DESCRIPTIONS

SCLK—Serial Clock

The serial clock pin is used to synchronize data to and from the AD9856 and to run the internal state machines. SCLK maximum frequency is 10 MHz.

\overline{CS} —Chip Select

Active low input that allows more than one device on the same serial communications lines. The SDO and SDIO pins go to a high impedance state when this input is high. If driven high during any communications cycle, that cycle is suspended until \overline{CS} is reactivated low. Chip Select can be tied low in systems that maintain control of SCLK.

SDIO—Serial Data I/O

Data is always written into the AD9856 on this pin. However, this pin can be used as a bidirectional data line. The configuration of this pin is controlled by Bit 7 of register address 0h. The default is Logic 0, which configures the SDIO pin as bidirectional.

SDO—Serial Data Out

Data is read from this pin for protocols that use separate lines for transmitting and receiving data. In the case where the AD9856 operates in a single bidirectional I/O mode, this pin does not output data and is set to a high impedance state.

SYNC I/O

Synchronizes the I/O port state machines without affecting the addressable registers contents. An active high input on the SYNC I/O pin causes the current communication cycle to abort. After SYNC I/O returns low (Logic 0), another communication cycle may begin, starting with the instruction byte write.

CA CLK

Output clock pin to the AD8320/AD8321. If using the AD9856 to control the AD8320/AD8321 programmable cable driver amplifier, connect this pin to the CLK input of the AD8320/AD8321.

CA DATA

Output data pin to the AD8320/AD8321. If using the AD9856 to control the AD8320/AD8321 programmable cable driver amplifier, connect this pin to the SDATA input of the AD8320/AD8321.

CA ENABLE

Output Enable pin to the AD8320/AD8321. If using the AD9856 to control the AD8320/AD8321 programmable cable driver amplifier, connect this pin to the \overline{DATEN} input of the AD8320/AD8321.

MSB/LSB TRANSFERS

The AD9856 serial port can support both MSB-first or LSB-first data formats. This functionality is controlled by the REG0<6> bit. The default value of REG0<6> is low (MSB first). When

REG0<6> is set active high, the AD9856 serial port is in LSB first format. The instruction byte must be written in the format indicated by REG0<6>. That is, if the AD9856 is in LSB-first mode, the instruction byte must be written from least significant bit to most significant bit. Multibyte data transfers in MSB format can be completed by writing an instruction byte that includes the register address of the most significant byte. In MSB-first mode, the serial port internal byte address generator decrements for each byte required of the multibyte communication cycle. Multibyte data transfers in LSB-first format can be completed by writing an instruction byte that includes the register address of the least significant byte. In LSB-first mode, the serial port internal byte address generator increments for each byte required of the multibyte communication cycle.

NOTES ON SERIAL PORT OPERATION

The AD9856 serial port configuration bits reside in Bit 6 and Bit 7 of register address 0h. It is important to note that the configuration changes immediately upon writing to this register. For multibyte transfers, writing to this register may occur during the middle of a communication cycle. Care must be taken to compensate for this new configuration for the remainder of the current communication cycle.

The AD9856 serial port controller address can roll from 19h to 0h for multibyte I/O operations if the MSB-first mode is active. The serial port controller address can roll from 0h to 19h for multibyte I/O operations if the LSB-first mode is active.

The system must maintain synchronization with the AD9856 or the internal control logic is not able to recognize further instructions. For example, if the system sends an instruction byte for a 2-byte write, then pulses the SCLK pin for a 3-byte write (24 additional SCLK rising edges), communication synchronization is lost. In this case, the first 16 SCLK rising edges after the instruction cycle properly write the first two data bytes into the AD9856, but the next eight rising SCLK edges are interpreted as the next instruction byte, not the final byte of the previous communication cycle.

In the case where synchronization is lost between the system and the AD9856, the SYNC I/O pin provides a means to reestablish synchronization without reinitializing the entire chip. The SYNC I/O pin enables the user to reset the AD9856 state machine to accept the next eight SCLK rising edges to be coincident with the instruction phase of a new communication cycle. By applying and removing a high signal to the SYNC I/O pin, the AD9856 is set to once again begin performing the communication cycle in synchronization with the system. Any information that had been written to the AD9856 registers during a valid communication cycle prior to loss of synchronization remains intact.

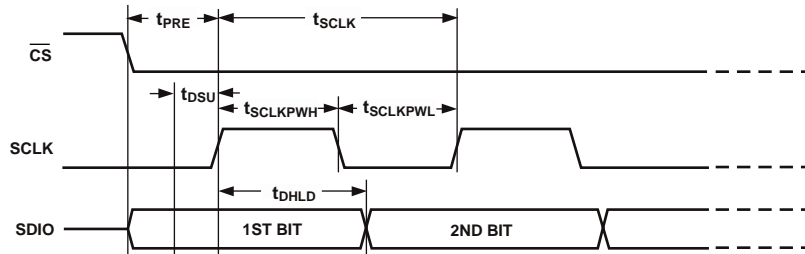

SYMBOL	DEFINITION	MIN
t_{PRE}	\overline{CS} SETUP TIME	30ns
t_{SCLK}	PERIOD OF SERIAL DATA CLOCK	100ns
t_{DSU}	SERIAL DATA SETUP TIME	30ns
$t_{SCLKPWH}$	SERIAL DATA CLOCK PULSEWIDTH HIGH	40ns
$t_{SCLKPWL}$	SERIAL DATA CLOCK PULSEWIDTH LOW	40ns
t_{DHL}	SERIAL DATA HOLD TIME	0ns

00637-C-048

Figure 48. Timing Diagram for Data Write to AD9856

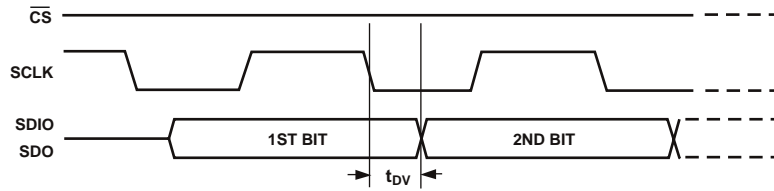

SYMBOL	DEFINITION	MAX
t_{DV}	DATA VALID TIME	30ns

00637-C-049

Figure 49. Timing Diagram for Read from AD9856

AD9856

PROGRAMMING/Writing THE AD8320/AD8321 CABLE DRIVER AMPLIFIER GAIN CONTROL

Programming the gain control register of the AD8320/AD8321 programmable cable driver amplifier can be accomplished via the AD9856 serial port. Four 8-bit registers (one per profile) within the AD9856 store the gain value to be written to the AD8320/AD8321. The AD8320/AD8321 is written via three dedicated AD9856 output pins that are directly connected to the AD8320/AD8321 serial input port. The transfer of data from the AD9856 to the AD8320/AD8321 requires 136 SYSCLK clock cycles and occurs upon detection of three conditions. Each condition is described next.

Power-Up Reset

Upon initial power up, the AD9856 clears (Logic 0) the contents of control registers 07h, 0Dh, 13h, and 19h, which defines the lowest gain setting of the AD8320/AD8321. Thus, the AD9856 writes all 0s out of the AD8320/AD8321 serial interface.

Change in Profile Selection Bits (PS1, PS0)

The AD9856 samples the PS1, PS0 input pins and writes to the AD8320/AD8321 gain control register when a change in profile is determined. The data written to the AD8320/AD8321 comes from the AD9856 gain control register associated with the current profile.

Serial Port Write of AD9856 Registers Containing AD8320/AD8321 Data

The AD9856 writes to the AD8320/AD8321 with data from the gain control register associated with the current profile whenever any AD9856 gain control register is updated. The user does not have to write the AD9856 in any particular order or to be concerned with time between writes. If the AD9856 is currently writing to the AD8320/AD8321 while one of the four AD9856 gain control registers is being addressed, the AD9856 immediately terminates the AD8320/AD8321 write sequence (without updating the AD8320/AD8321) and begins a new AD8320/AD8321 write sequence.

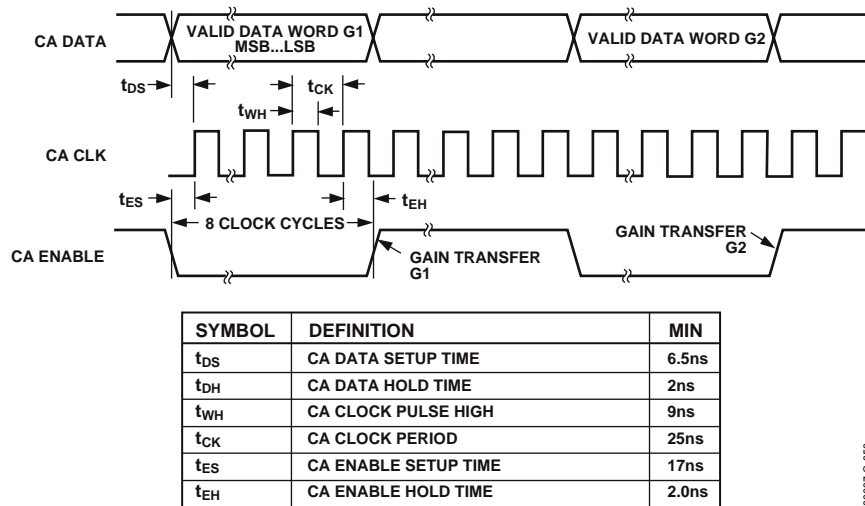

Figure 50. Programmable Cable Driver Amplifier Output Control Interface Timing

UNDERSTANDING AND USING PIN-SELECTABLE MODULATOR PROFILES

The AD9856 quadrature digital upconverter is capable of storing four preconfigured modulation modes called profiles that define the following:

- Output frequency—32 bits
- Interpolation rate—6 bits
- Spectral inversion status—1 bit
- Bypass third half-band filter—1 bit
- Gain control of AD8320/AD8321—8 bits

Output Frequency

This attribute consists of four 8-bit words loaded into four register addresses to form a 32-bit frequency tuning word (FTW) for each profile. The lowest register address corresponds to the least significant 8-bit word. Ascending addresses correspond to increasingly significant 8-bit words. The output frequency equation is given as: $f_{OUT} = (FTW \times SYSCLK)/2^{32}$.

Interpolation Rate

Consists of a 6-bit word representing the allowed interpolation values from 2 to 63. Interpolation is the mechanism used to up sample or multiply the input data rate such that it exactly matches that of the DDS sample rate (SYSCLK). This implies that the system clock must be an exact multiple of the symbol rate. This 6-bit word represents the 6 MSBs of the eight bits allocated for that address. The remaining two bits contain the spectral inversion status bit and half-band bypass bit.

Spectral Inversion

Single bit that when at Logic 0 the default or noninverted output from the adder is sent to the following stages. A Logic 1 causes the inverted output to be sent to the following stages.

The noninverted output is described as

$$I \times \cos(\omega t) - Q \times \sin(\omega t).$$

The inverted output is described as

$$I \times \cos(\omega t) + Q \times \sin(\omega t).$$

This bit is located adjacent to the LSB at the same address as the interpolation rate previously described.

Bypass Third Half-Band Filter

A single bit located in the LSB position of the same address as the interpolation rate. When this bit is Logic 0, the third half-band filter is engaged and its inherent 2× interpolation rate is applied. When this bit is Logic 1, the third half-band filter is bypassed and the 2× interpolation rate is negated. This allows users to input higher data rates—rates that may be too high for the minimum interpolation rate if all three half-band filters with their inherent 2× interpolation rate are engaged. The effect is to reduce the minimum interpolation rate from 8× to 4×.

AD8320/AD8321 Gain Control

An 8-bit word that controls the gain of an AD8320/AD8321 programmable gain amplifier connected to the AD9856 with the 3-bit SPI interface bus. Gain range is from –10 dB (00 hex) to +26 dB (FFhex). The gain is linear in V/V/LSB and follows the equation $A_V = 0.316 + 0.077 \times Code$, where *Code* is the decimal equivalent of the 8-bit gain word.

Profile Selection

After profiles have been loaded into the appropriate registers, the user may select which profile to use with two input pins: PS0 and PS1, Pins 45 and 46. Table 9 shows how profiles are selected.

Table 9. Profile Select Matrix

PS1	PS0	PROFILE
0	0	1
0	1	2
1	0	3
1	1	4

Except while in single-tone mode, it is recommended that users suspend the TxENABLE function by bringing the pin to Logic 0 prior to changing from one profile to another and then re-asserting TxENABLE. This assures that any discontinuities resulting from register data transfer are not transmitted up or downstream. Furthermore, changing interpolation rates during a burst may create an unrecoverable digital overflow condition that interrupts transmission of the current burst until a RESET and reloading procedure is completed.

POWER DISSIPATION CONSIDERATIONS

The majority of the AD9856 power dissipation comes from digital switching currents. As such, power dissipation is highly dependent upon chip configuration.

The major contributor to switching current is the maximum clock rate at which the device is operated, but other factors can play a significant role. Factors such as the CIC interpolation rate, and whether the third half-band filter and inverse SINC filters are active, can affect the power dissipation of the device.

It is important for the user to consider all of these factors when optimizing performance for power dissipation. For example, there are two ways to achieve a 6 MS/s transmission rate with the AD9856. The first method uses an f_{MAX} of 192 MHz; the other method uses an f_{MAX} of 144 MHz, which reduces power dissipation by nearly 25%.

For the first method, the input data must be externally 4× upsampled. The AD9856 must be configured for a CIC interpolation rate of three while bypassing the 3rd half-band filter. This results in an I/Q input sample rate of 24 MHz which is further upsampled by a factor of 8 MHz to 192 MHz.

AD9856

The second method requires an f_{MAX} of 144 MHz with externally $2\times$ upsampled input data. The AD9856 is configured for a CIC interpolation rate of 3 while bypassing the 3rd half-band filter. The input I/Q sample rate is 12 MHz, which is further upsampled by a factor of 12 MHz to 144 MHz.

For burst applications with relatively long nonbursting periods, the sleep bit is useful for saving power. When in sleep mode, power is reduced to below 6 mW. Consideration must be given to wake-up time, which generally is in the 400 μs to 750 μs range. For applications that cannot use the sleep bit due to this wake-up time, there is an alternate method of reducing power dissipation when not transmitting. By writing the bypass REFCLK multiplier bit active, the power is reduced by nearly the REFCLK multiplier factor. For example, if the external reference clock is 16 MHz and REFCLK multiplier is set to $10\times$, all clocks divide down by a factor of 10 when the REFCLK multiplier is bypassed. This effectively scales down the power dissipation by nearly a factor of 10. In this case, both the REFCLK multiplier function and the DAC, which use relatively little power, remain fully powered. The REFCLK multiplier circuit is locked to the 16 MHz external reference clock, but its output is driving a very small load—thus, there is little power dissipation. When the REFCLK multiplier is reactivated, the acquisition time is small. In this power reduction technique, the larger the REFCLK multiplier factor, the larger the power savings.

The AD9856 is specified for operation at $+3.0\text{ V} \pm 5\%$. The thermal impedance of the device in the 48-LQFP plastic package is $38^\circ\text{C}/\text{W}$. At 200 MHz operation, power dissipation

is 1.5 W. This permits operation over the industrial temperature range without exceeding the maximum junction temperature of 150°C . To realize this quoted thermal impedance, all power and ground pins must be soldered down to a multilayer PCB with power and ground copper planes directly available at the package pins.

Under worst-case conditions, that is, with power supplies at 2.85 V and ambient temperatures of 85°C , device operation at 200 MHz is guaranteed for single-tone mode only. For modulation mode at 200 MHz, 85°C operation, the minimum power supply voltage is 3.0 V.

AD9856 EVALUATION BOARD

An evaluation board is available to facilitate bench and system analysis of AD9856 quadrature digital upconverter. The AD9856 printed circuit board (PCB) contains the AD9856 device and Windows® software that the device to be controlled via the printer port of a PC. The DAC output is provided on a jack for spectral analysis. The AD9856/PCB provides a single-ended 65 MHz, $5\ \Omega$, elliptical low-pass filter on the output of the DAC.

The user can also implement the AD8320/AD8321 programmable cable driver amplifier on the AD9856/PCB evaluation board. The AD8320/AD8321 gain is programmed through the AD9856 via the menu driven control software.

SUPPORT

Applications assistance is available for the AD9856 and the AD9856/PCB evaluation board. Please call 1-800-ANALOGD or visit www.analog.com.

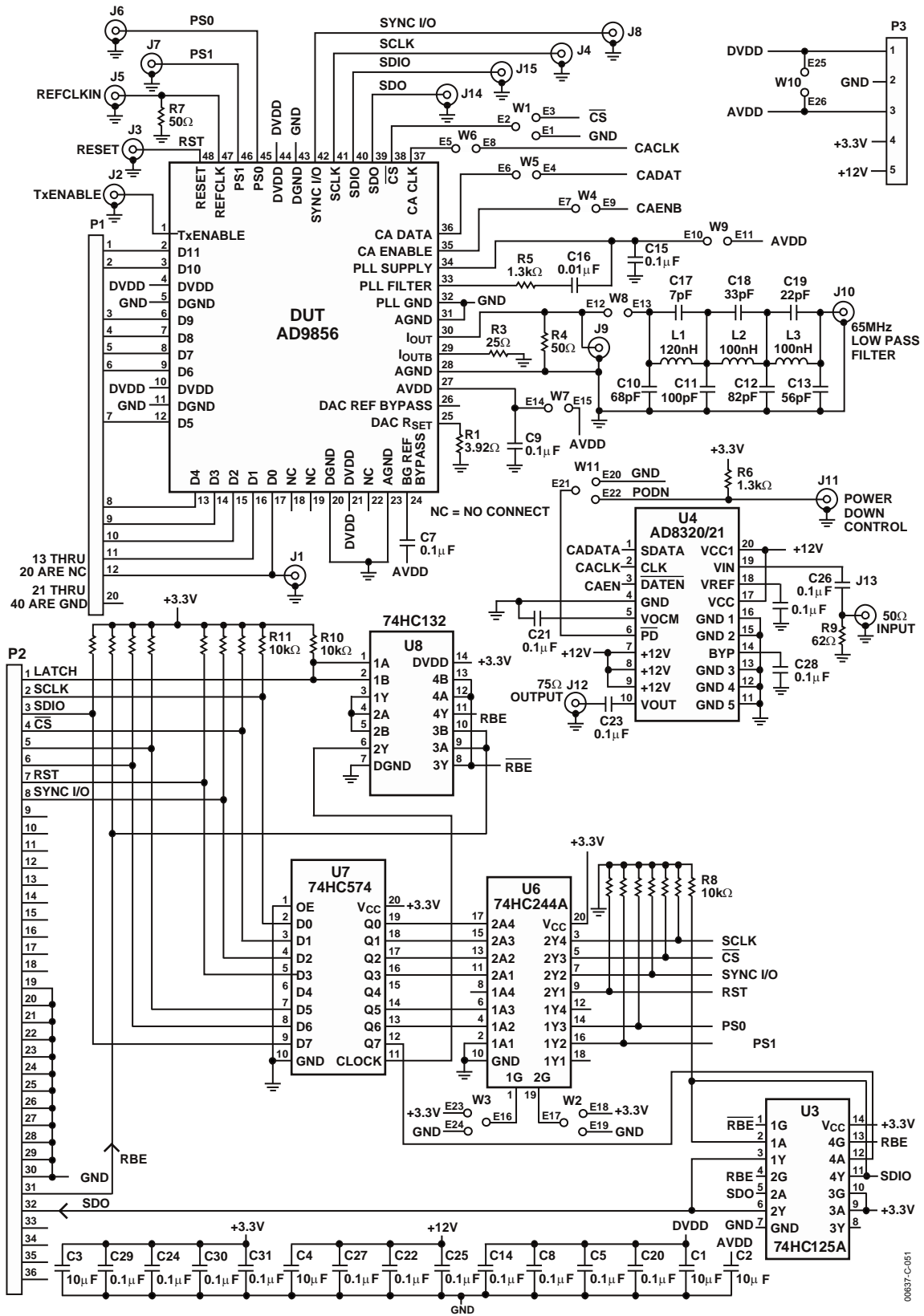

Figure 51. AD9856/PCB Evaluation Board Electrical Schematic

AD9856

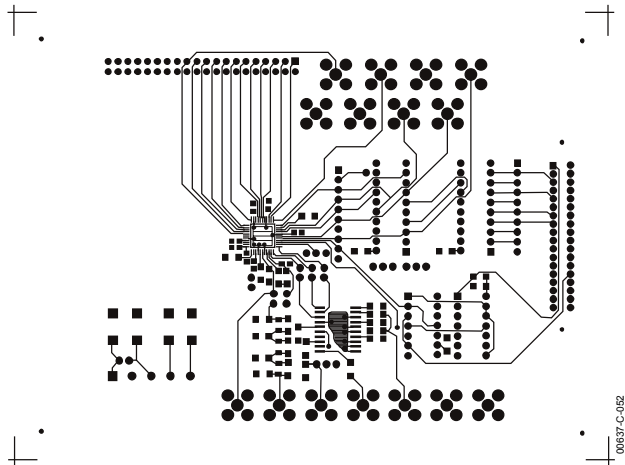

Figure 52. PCB Lay Out Pattern for Four-Layer AD9856 PCB Evaluation Board Layer 1 (Top)—Signal Routing and Ground Plane

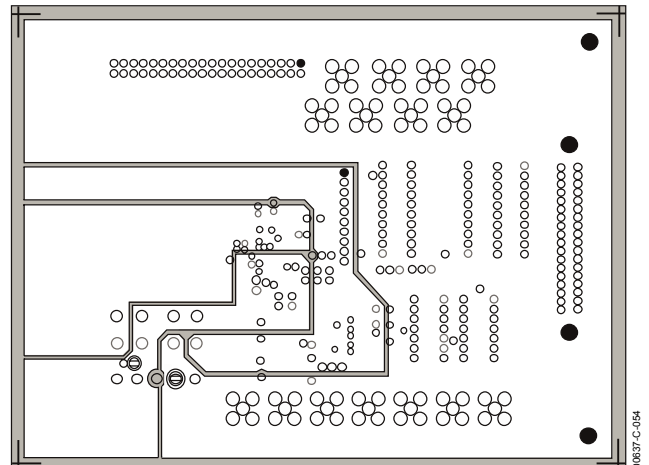

Figure 54. PCB Lay Out Pattern for Four-Layer AD9856 PCB Evaluation Board Layer 3—DUT +V, +5 V and 12 V Power Plane

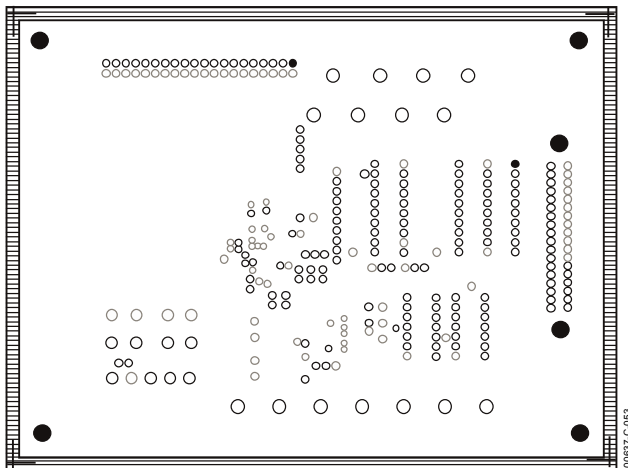

Figure 53. PCB Lay Out Pattern for Four-Layer AD9856 PCB Evaluation Board Layer 2—Ground Plane

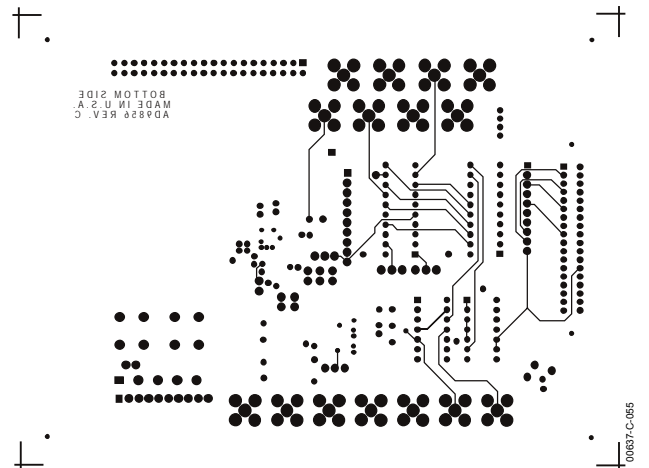

Figure 55. PCB Lay Out Pattern for Four-Layer AD9856 PCB Evaluation Board Layer 4 (Bottom)—Signal Routing

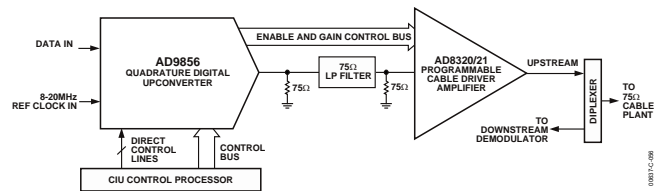

Figure 56. Basic Implementation of AD9856 Digital Modulator and AD8320/AD8321 Programmable Cable Driver Amplifier in 5 MHz to 65 MHz HFC Return-Path Application

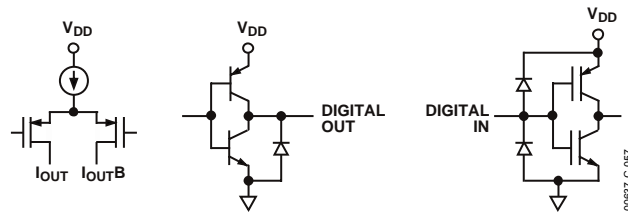
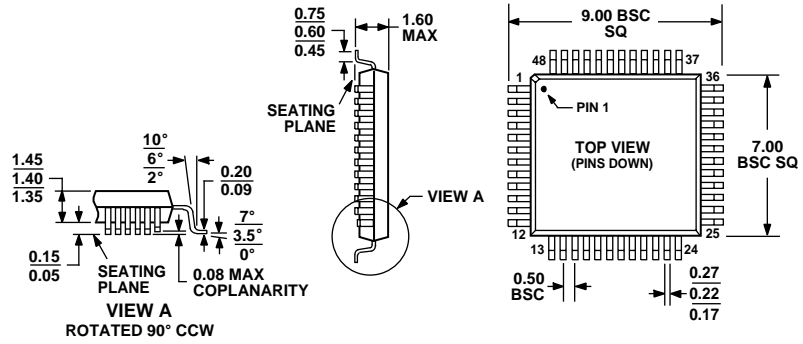

Figure 57. Equivalent I/O Circuits

OUTLINE DIMENSIONS



COMPLIANT TO JEDEC STANDARDS MS-026BBC

Figure 58. 48-Lead Low Profile Quad Flat Package [LQFP] (ST-48)

Dimensions shown in inches millimeters

ORDERING GUIDE

Model	Temperature Range	Package Description	Package Option
AD9856AST	-40° C to +85° C	48-Lead Low Profile Quad Flat Package [LQFP]	ST-48
AD9856/PCB		Evaluation Board	

AD9856

NOTES



Компания «ЭлектроПласт» предлагает заключение долгосрочных отношений при поставках импортных электронных компонентов на взаимовыгодных условиях!

Наши преимущества:

- Оперативные поставки широкого спектра электронных компонентов отечественного и импортного производства напрямую от производителей и с крупнейших мировых складов;
- Поставка более 17-ти миллионов наименований электронных компонентов;
- Поставка сложных, дефицитных, либо снятых с производства позиций;
- Оперативные сроки поставки под заказ (от 5 рабочих дней);
- Экспресс доставка в любую точку России;
- Техническая поддержка проекта, помощь в подборе аналогов, поставка прототипов;
- Система менеджмента качества сертифицирована по Международному стандарту ISO 9001;
- Лицензия ФСБ на осуществление работ с использованием сведений, составляющих государственную тайну;
- Поставка специализированных компонентов (Xilinx, Altera, Analog Devices, Intersil, Interpoint, Microsemi, Aeroflex, Peregrine, Syfer, Eurofarad, Texas Instrument, Miteq, Cobham, E2V, MA-COM, Hittite, Mini-Circuits, General Dynamics и др.);

Помимо этого, одним из направлений компании «ЭлектроПласт» является направление «Источники питания». Мы предлагаем Вам помощь Конструкторского отдела:

- Подбор оптимального решения, техническое обоснование при выборе компонента;
- Подбор аналогов;
- Консультации по применению компонента;
- Поставка образцов и прототипов;
- Техническая поддержка проекта;
- Защита от снятия компонента с производства.



Как с нами связаться

Телефон: 8 (812) 309 58 32 (многоканальный)

Факс: 8 (812) 320-02-42

Электронная почта: org@eplast1.ru

Адрес: 198099, г. Санкт-Петербург, ул. Калинина, дом 2, корпус 4, литера А.