

## IR Receiver Modules for Remote Control Systems



19026

### MECHANICAL DATA

#### Pinning:

1 = OUT, 2 = GND, 3 =  $V_S$

### FEATURES

- Very low supply current
- Photo detector and preamplifier in one package
- Internal filter for PCM frequency
- Improved shielding against EMI
- Supply voltage: 2.5 V to 5.5 V
- Improved immunity against ambient light
- Insensitive to supply voltage ripple and noise
- Component in accordance to RoHS 2002/95/EC and WEEE 2002/96/EC



### DESCRIPTION

The TSOP382.., TSOP384.. series are miniaturized receivers for infrared remote control systems. A PIN diode and a preamplifier are assembled on a lead frame, the epoxy package acts as an IR filter.

The demodulated output signal can be directly decoded by a microprocessor. The TSOP382.. is compatible with all common IR remote control data formats. The TSOP384.. is optimized to suppress almost all spurious pulses from energy saving fluorescent lamps but will also suppress some data signals.

This component has not been qualified according to automotive specifications.

### PARTS TABLE

| CARRIER FREQUENCY | STANDARD APPLICATIONS (AGC2/AGC8) | VERY NOISY ENVIRONMENTS (AGC4) |
|-------------------|-----------------------------------|--------------------------------|
| 30 kHz            | TSOP38230                         | TSOP38430                      |
| 33 kHz            | TSOP38233                         | TSOP38433                      |
| 36 kHz            | TSOP38236                         | TSOP38436                      |
| 38 kHz            | TSOP38238                         | TSOP38438                      |
| 40 kHz            | TSOP38240                         | TSOP38440                      |
| 56 kHz            | TSOP38256                         | TSOP38456                      |

### BLOCK DIAGRAM



### APPLICATION CIRCUIT

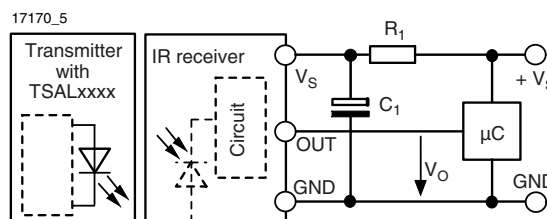

$R_1$  and  $C_1$  are recommended for protection against EOS. Components should be in the range of  $33 \Omega < R_1 < 1 \text{ k}\Omega$ ,  $C_1 > 0.1 \mu\text{F}$ .



| ABSOLUTE MAXIMUM RATINGS (1) |                                       |           |                          |      |
|------------------------------|---------------------------------------|-----------|--------------------------|------|
| PARAMETER                    | TEST CONDITION                        | SYMBOL    | VALUE                    | UNIT |
| Supply voltage (pin 3)       |                                       | $V_S$     | - 0.3 to + 6.0           | V    |
| Supply current (pin 3)       |                                       | $I_S$     | 3                        | mA   |
| Output voltage (pin 1)       |                                       | $V_O$     | - 0.3 to ( $V_S + 0.3$ ) | V    |
| Output current (pin 1)       |                                       | $I_O$     | 5                        | mA   |
| Junction temperature         |                                       | $T_j$     | 100                      | °C   |
| Storage temperature range    |                                       | $T_{stg}$ | - 25 to + 85             | °C   |
| Operating temperature range  |                                       | $T_{amb}$ | - 25 to + 85             | °C   |
| Power consumption            | $T_{amb} \leq 85 \text{ °C}$          | $P_{tot}$ | 10                       | mW   |
| Soldering temperature        | $t \leq 10 \text{ s, 1 mm from case}$ | $T_{sd}$  | 260                      | °C   |

**Note**

(1) Stresses beyond those listed under "Absolute Maximum Ratings" may cause permanent damage to the device. This is a stress rating only and functional operation of the device at these or any other conditions beyond those indicated in the operational sections of this specification is not implied. Exposure to absolute maximum rating conditions for extended periods may affect the device reliability.

| ELECTRICAL AND OPTICAL CHARACTERISTICS (1) |  |                    |      |          |      |                 |
|--|--|--------------------|------|----------|------|-----------------|
| PARAMETER                                  | TEST CONDITION   | SYMBOL             | MIN. | TYP.     | MAX. | UNIT            |
| Supply current (pin 3)                     | $E_v = 0, V_S = 3.3 \text{ V}$   | $I_{SD}$           | 0.27 | 0.35     | 0.45 | mA              |
|  | $E_v = 40 \text{ klx, sunlight}$   | $I_{SH}$           |      | 0.45     |      | mA              |
| Supply voltage                             |  | $V_S$              | 2.5  |          | 5.5  | V               |
| Transmission distance                      | $E_v = 0$ , test signal see fig. 1, IR diode TSAL6200, $I_F = 250 \text{ mA}$              | $d$                |      | 45       |      | m               |
| Output voltage low (pin 1)                 | $I_{OSL} = 0.5 \text{ mA, } E_e = 0.7 \text{ mW/m}^2$ , test signal see fig. 1             | $V_{OSL}$          |      |          | 100  | mV              |
| Minimum irradiance                         | Pulse width tolerance: $t_{pi} - 5/f_0 < t_{po} < t_{pi} + 6/f_0$ , test signal see fig. 1 | $E_e \text{ min.}$ |      | 0.15     | 0.35 | $\text{mW/m}^2$ |
| Maximum irradiance                         | $t_{pi} - 5/f_0 < t_{po} < t_{pi} + 6/f_0$ , test signal see fig. 1                        | $E_e \text{ max.}$ | 30   |          |      | $\text{W/m}^2$  |
| Directivity                                | Angle of half transmission distance  | $\phi_{1/2}$       |      | $\pm 45$ |      | deg             |

**Note**

(1)  $T_{amb} = 25 \text{ °C}$ , unless otherwise specified

**TYPICAL CHARACTERISTICS**

$T_{amb} = 25 \text{ °C}$ , unless otherwise specified

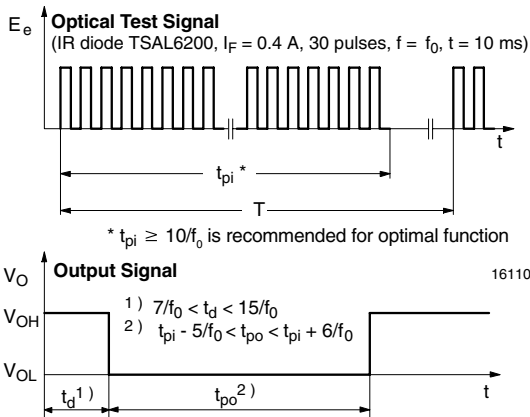

Fig. 1 - Output Active Low

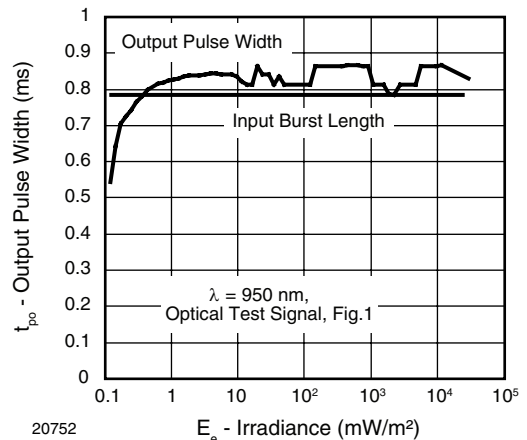

Fig. 2 - Pulse Length and Sensitivity in Dark Ambient



Fig. 3 - Output Function



20757

Fig. 6 - Sensitivity in Bright Ambient



20759

Fig. 4 - Output Pulse Diagram



20753

Fig. 7 - Sensitivity vs. Supply Voltage Disturbances



16925

Fig. 5 - Frequency Dependence of Responsivity



20747

Fig. 8 - Sensitivity vs. Electric Field Disturbances

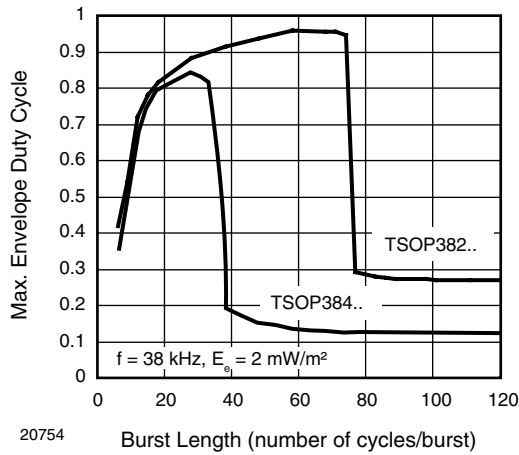

Fig. 9 - Max. Envelope Duty Cycle vs. Burst Length

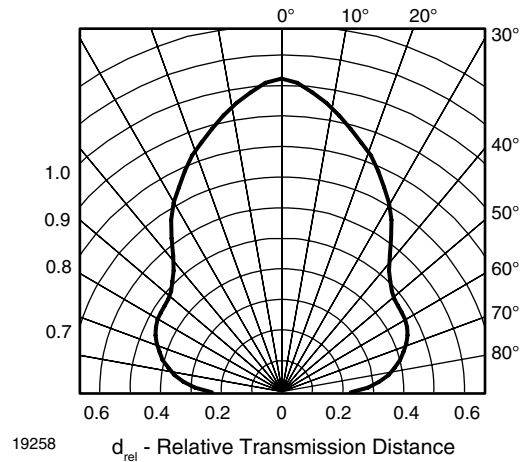

Fig. 12 - Horizontal Directivity

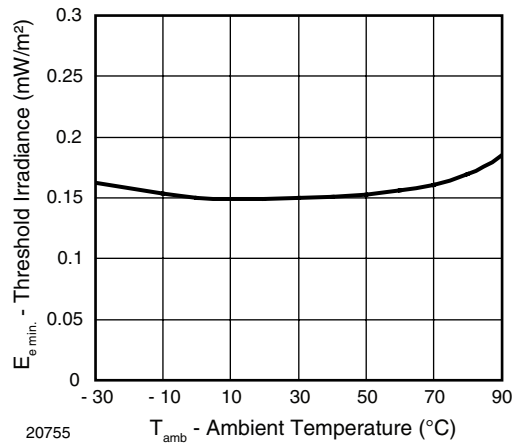

Fig. 10 - Sensitivity vs. Ambient Temperature

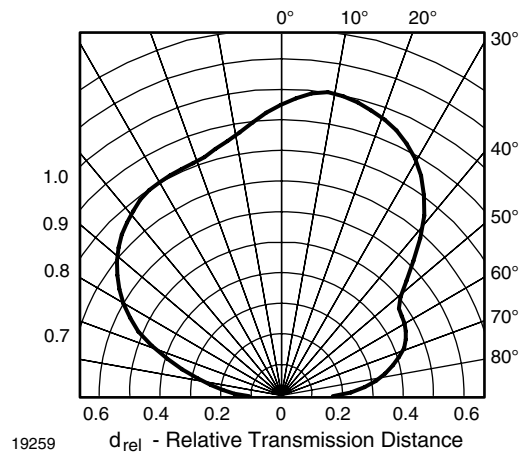

Fig. 13 - Vertical Directivity

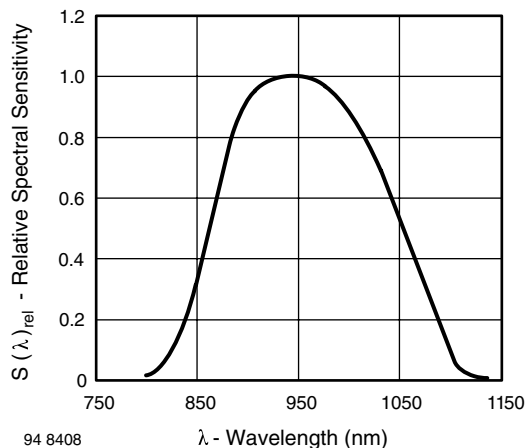

Fig. 11 - Relative Spectral Sensitivity vs. Wavelength

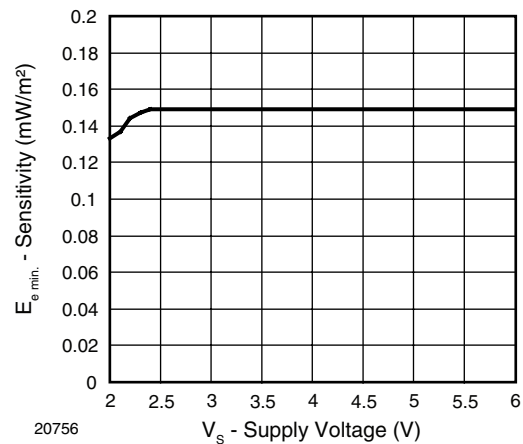

Fig. 14 - Sensitivity vs. Supply Voltage

## SUITABLE DATA FORMAT

The TSOP382.., TSOP384.. series are designed to suppress spurious output pulses due to noise or disturbance signals. Data and disturbance signals can be distinguished by the devices according to carrier frequency, burst length and envelope duty cycle. The data signal should be close to the band-pass center frequency (e.g. 38 kHz) and fulfill the conditions in the table below.

When a data signal is applied to the TSOP382.., TSOP384.. in the presence of a disturbance signal, the sensitivity of the receiver is reduced to insure that no spurious pulses are present at the output. Some examples of disturbance signals which are suppressed are:

- DC light (e.g. from tungsten bulb or sunlight)
- Continuous signals at any frequency
- Strongly or weakly modulated noise from fluorescent lamps with electronic ballasts (see figure 15 or figure 16)



Fig. 15 - IR Signal from Fluorescent Lamp with Low Modulation



Fig. 16 - IR Signal from Fluorescent Lamp with High Modulation

|  | TSOP382..                                      | TSOP384..                                       |
|--|--|---|
| Minimum burst length   | 10 cycles/burst                                | 10 cycles/burst                                 |
| After each burst of length a minimum gap time is required of               | 10 to 70 cycles<br>≥ 10 cycles                 | 10 to 35 cycles<br>≥ 10 cycles                  |
| For bursts greater than a minimum gap time in the data stream is needed of | 70 cycles<br>> 4 x burst length                | 35 cycles<br>> 10 x burst length                |
| Maximum number of continuous short bursts/second                           | 1800   | 1500  |
| Compatible to NEC code   | yes  | yes   |
| Compatible to RC5/RC6 code   | yes  | yes   |
| Compatible to Sony code  | yes  | no  |
| Compatible to Thomson 56 kHz code  | yes  | yes   |
| Compatible to Mitsubishi code (38 kHz, preburst 8 ms, 16 bit)              | yes  | no  |
| Compatible to Sharp code   | yes  | yes   |
| Suppression of interference from fluorescent lamps                         | Most common disturbance signals are suppressed | Even extreme disturbance signals are suppressed |

### Note

For data formats with short bursts please see the datasheet for TSOP381.., TSOP383..



PACKAGE DIMENSIONS in millimeters

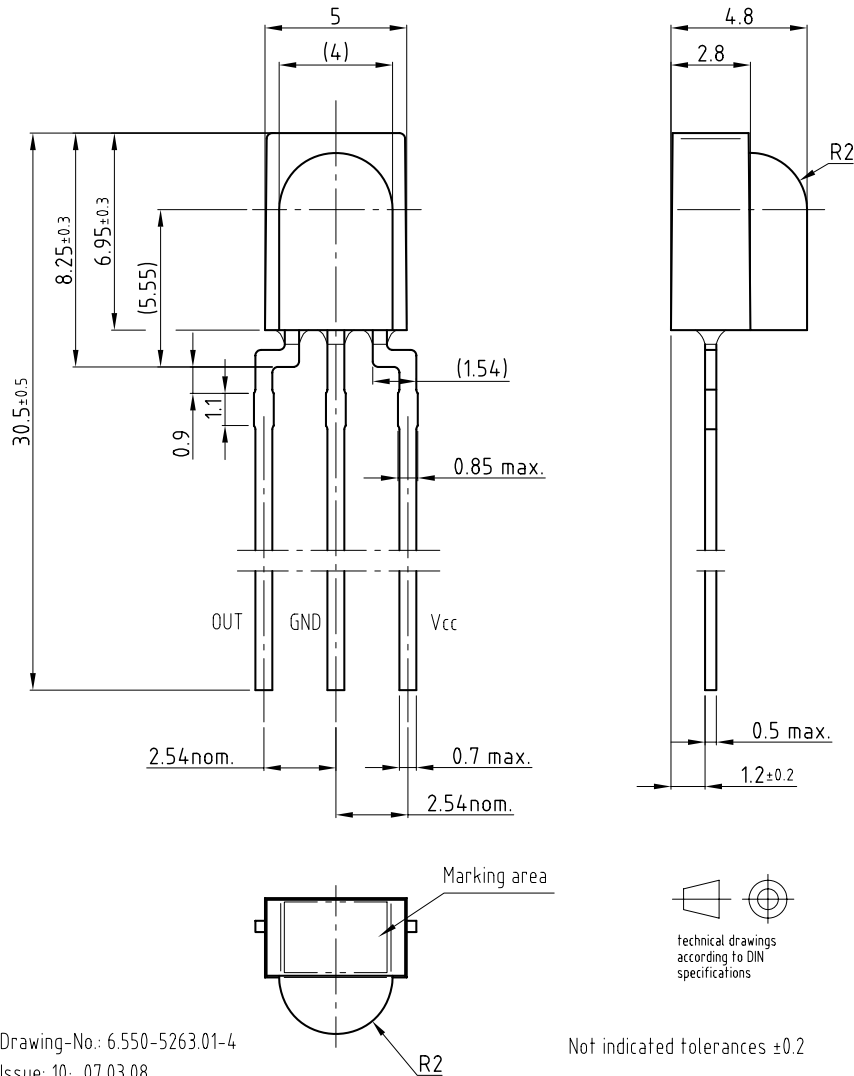

Drawing-No.: 6.550-5263.01-4  
Issue: 10; 07.03.08  
19009

Not indicated tolerances  $\pm 0.2$

## **OZONE DEPLETING SUBSTANCES POLICY STATEMENT**

It is the policy of Vishay Semiconductor GmbH to

1. Meet all present and future national and international statutory requirements.
2. Regularly and continuously improve the performance of our products, processes, distribution and operating systems with respect to their impact on the health and safety of our employees and the public, as well as their impact on the environment.

It is particular concern to control or eliminate releases of those substances into the atmosphere which are known as ozone depleting substances (ODSs).

The Montreal Protocol (1987) and its London Amendments (1990) intend to severely restrict the use of ODSs and forbid their use within the next ten years. Various national and international initiatives are pressing for an earlier ban on these substances.

Vishay Semiconductor GmbH has been able to use its policy of continuous improvements to eliminate the use of ODSs listed in the following documents.

1. Annex A, B and list of transitional substances of the Montreal Protocol and the London Amendments respectively.
2. Class I and II ozone depleting substances in the Clean Air Act Amendments of 1990 by the Environmental Protection Agency (EPA) in the USA.
3. Council Decision 88/540/EEC and 91/690/EEC Annex A, B and C (transitional substances) respectively.

Vishay Semiconductor GmbH can certify that our semiconductors are not manufactured with ozone depleting substances and do not contain such substances.

We reserve the right to make changes to improve technical design  
and may do so without further notice.

Parameters can vary in different applications. All operating parameters must be validated for each customer application by the customer. Should the buyer use Vishay Semiconductors products for any unintended or unauthorized application, the buyer shall indemnify Vishay Semiconductors against all claims, costs, damages, and expenses, arising out of, directly or indirectly, any claim of personal damage, injury or death associated with such unintended or unauthorized use.

Vishay Semiconductor GmbH, P.O.B. 3535, D-74025 Heilbronn, Germany



## Disclaimer

All product specifications and data are subject to change without notice.

Vishay Intertechnology, Inc., its affiliates, agents, and employees, and all persons acting on its or their behalf (collectively, "Vishay"), disclaim any and all liability for any errors, inaccuracies or incompleteness contained herein or in any other disclosure relating to any product.

Vishay disclaims any and all liability arising out of the use or application of any product described herein or of any information provided herein to the maximum extent permitted by law. The product specifications do not expand or otherwise modify Vishay's terms and conditions of purchase, including but not limited to the warranty expressed therein, which apply to these products.

No license, express or implied, by estoppel or otherwise, to any intellectual property rights is granted by this document or by any conduct of Vishay.

The products shown herein are not designed for use in medical, life-saving, or life-sustaining applications unless otherwise expressly indicated. Customers using or selling Vishay products not expressly indicated for use in such applications do so entirely at their own risk and agree to fully indemnify Vishay for any damages arising or resulting from such use or sale. Please contact authorized Vishay personnel to obtain written terms and conditions regarding products designed for such applications.

Product names and markings noted herein may be trademarks of their respective owners.





Компания «ЭлектроПласт» предлагает заключение долгосрочных отношений при поставках импортных электронных компонентов на взаимовыгодных условиях!

Наши преимущества:

- Оперативные поставки широкого спектра электронных компонентов отечественного и импортного производства напрямую от производителей и с крупнейших мировых складов;
- Поставка более 17-ти миллионов наименований электронных компонентов;
- Поставка сложных, дефицитных, либо снятых с производства позиций;
- Оперативные сроки поставки под заказ (от 5 рабочих дней);
- Экспресс доставка в любую точку России;
- Техническая поддержка проекта, помощь в подборе аналогов, поставка прототипов;
- Система менеджмента качества сертифицирована по Международному стандарту ISO 9001;
- Лицензия ФСБ на осуществление работ с использованием сведений, составляющих государственную тайну;
- Поставка специализированных компонентов (Xilinx, Altera, Analog Devices, Intersil, Interpoint, Microsemi, Aeroflex, Peregrine, Syfer, Eurofarad, Texas Instrument, Miteq, Cobham, E2V, MA-COM, Hittite, Mini-Circuits, General Dynamics и др.);

Помимо этого, одним из направлений компании «ЭлектроПласт» является направление «Источники питания». Мы предлагаем Вам помощь Конструкторского отдела:

- Подбор оптимального решения, техническое обоснование при выборе компонента;
- Подбор аналогов;
- Консультации по применению компонента;
- Поставка образцов и прототипов;
- Техническая поддержка проекта;
- Защита от снятия компонента с производства.



#### Как с нами связаться

**Телефон:** 8 (812) 309 58 32 (многоканальный)

**Факс:** 8 (812) 320-02-42

**Электронная почта:** [org@eplast1.ru](mailto:org@eplast1.ru)

**Адрес:** 198099, г. Санкт-Петербург, ул. Калинина, дом 2, корпус 4, литера А.