



SUCCESSIVE DETECTION LOG VIDEO AMPLIFIER (SDLVA), 0.6 - 20 GHz

Typical Applications

The HMC913LC4B is ideal for:

- EW, ELINT & IFM Receivers
- DF Radar Systems
- ECM Systems
- Broadband Test & Measurement
- Power Measurement & Control Circuits
- Military & Space Applications

Features

- High Logging Range: 59 dB (-54 to +5 dBm) @ 18 GHz
- Output Frequency Flatness: ± 2 dB
- Log Linearity: ± 1 dB
- Fast Rise/Fall Times: 5/10 ns
- Single Positive Supply: +3.3V
- ESD Sensitivity (HBM): Class 1A
- 24 Lead 4x4mm SMT Package: 16mm²

Functional Diagram

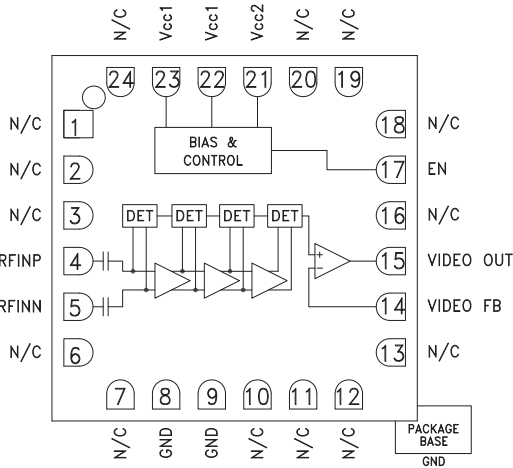

General Description

The HMC913LC4B is a Successive Detection Log Video Amplifier (SDLVA) which operates from 0.6 to 20 GHz. The HMC913LC4B provides a logging range of 59 dB. This device offers typical fast rise/fall times of 5/10 ns and a superior delay time of only 14 ns. The HMC913LC4B log video output slope is typically 14 mV/dB. Maximum recovery times are less than 30 ns. The HMC913LC4B is available in a highly compact 4x4 mm SMT ceramic package and is ideal for high speed channelized receiver applications.

Electrical Specifications, $T_A = +25^\circ\text{C}$ $V_{cc1} = V_{cc2} = +3.3\text{V}$

Parameter	Conditions	Typ.	Units
Input Frequency Range ^[1]		0.6 - 20	GHz
Frequency Flatness	Pin = -25 dBm	± 2	dB
Log Linearity	Pin = -50 to +3 dBm	± 1	dB
Log Linearity over Temperature	Pin = -25 dBm	± 1	dB
Minimum Logging Range	to ± 3 dB error @ 18 GHz	-54 @ 18 GHz	dBm
Maximum Logging Range	to ± 3 dB error @ 18 GHz	+5 @ 18 GHz	dBm
Input Return Loss		7	dB
Log Video Minimum Output Voltage		1	V
Log Video Maximum Output Voltage		1.8	V
Log Video Output Rise Time	10% to 90%	5	ns
Log Video Output Fall Time	90% to 10%	10	ns
Log Video Recovery Time		25	ns
Log Video Output Slope		14	mV/dB
Log Video Output Slope Variation over Temperature	@ 10 GHz	5	$\mu\text{V/dB}^\circ\text{C}$
Log Video Propagation Delay		14	ns
Supply Current (Icc1)		80	mA
Supply Current (Icc2)	@ Pin = -30 dBm	8	mA

[1] Electrical specs and performance plots are given for single-ended operation

SUCCESSIVE DETECTION LOG VIDEO AMPLIFIER (SDLVA), 0.6 - 20 GHz

Error Flatness vs. Input Power Over Frequency [1][2]

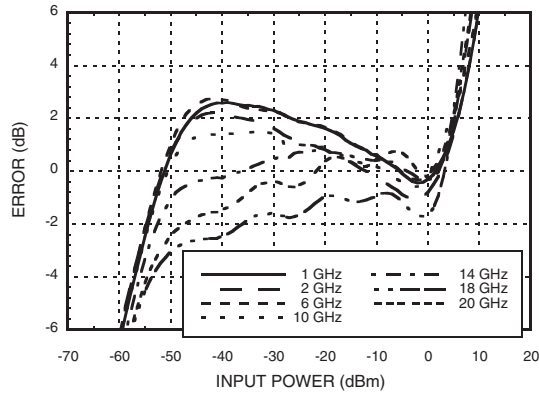

VIDEO OUT & Error vs. Input Power, Fin = 500 MHz [1]

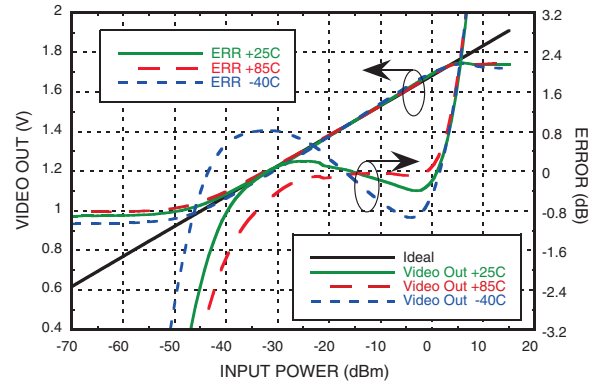

VIDEO OUT & Error vs. Input Power, Fin = 1 GHz [1]

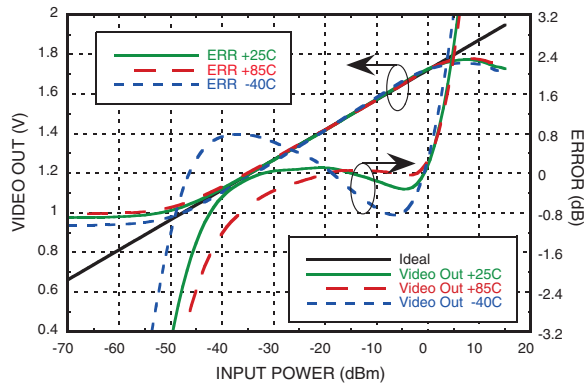

VIDEO OUT & Error vs. Input Power, Fin = 2 GHz [1]

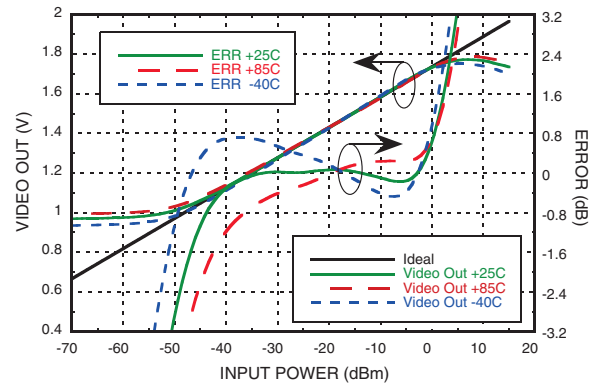

VIDEO OUT & Error vs. Input Power, Fin = 6 GHz [1]

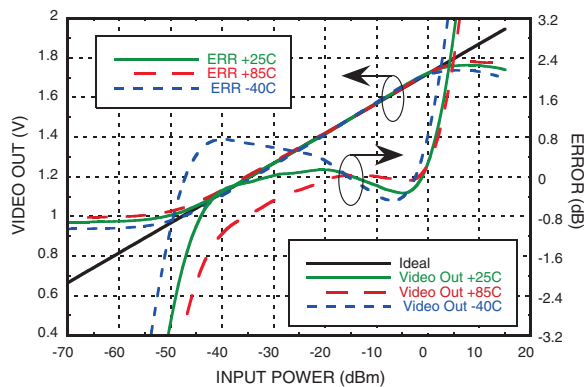

VIDEO OUT & Error vs. Input Power, Fin = 10 GHz [1]

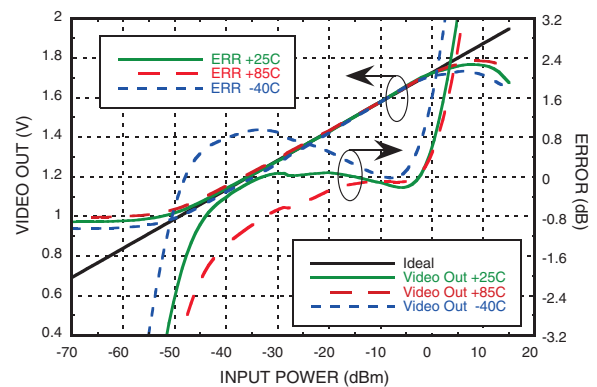

[1] Electrical Specs and performance plots are given for single-ended operation
[2] An average ideal line is used to calculate error curves.



SUCCESSIVE DETECTION LOG VIDEO AMPLIFIER (SDLVA), 0.6 - 20 GHz

VIDEO OUT & Error vs. Input Power, $F_{in} = 14$ GHz [1]

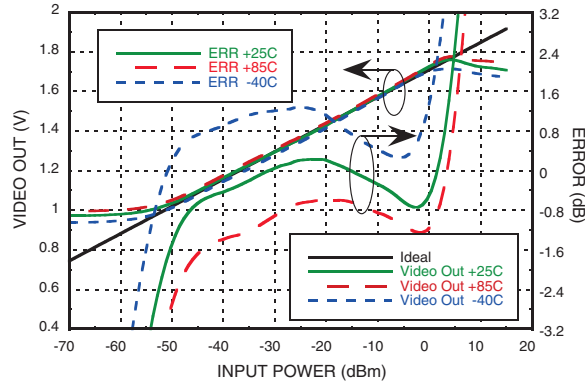

VIDEO OUT & Error vs. Input Power, $F_{in} = 18$ GHz [1]

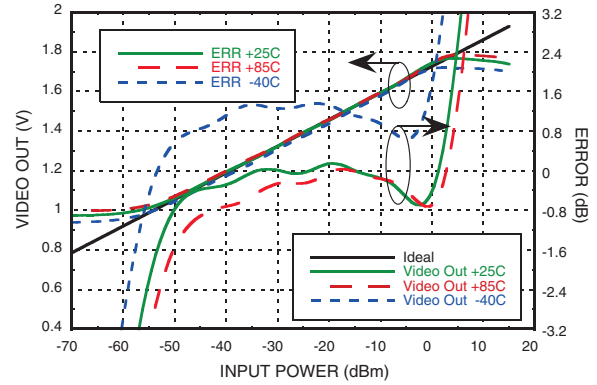

VIDEO OUT & Error vs. Input Power, $F_{in} = 20$ GHz [1]

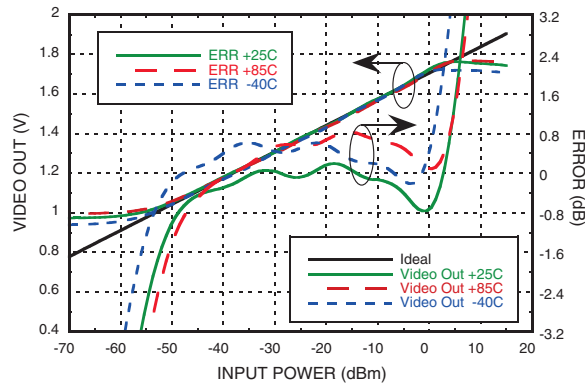

VIDEO OUT & Error vs. Input Power, $F_{in} = 26$ GHz [1]

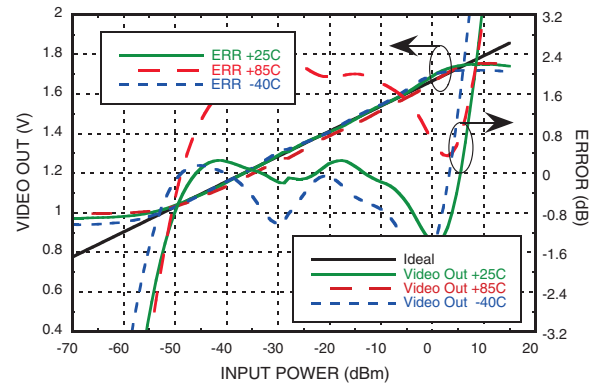

VIDEO OUT vs. Frequency Over Input Power & Temperature [1]

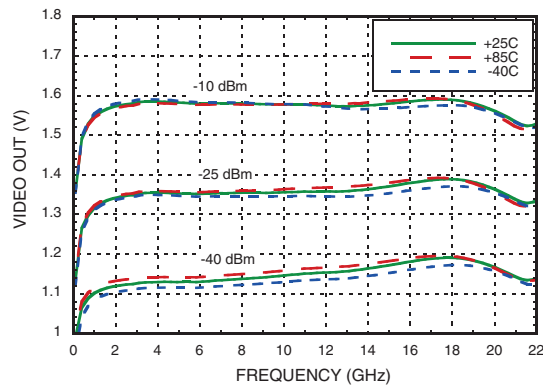

VIDEO OUT vs. Frequency Over Input Power & Bias Voltage [1]

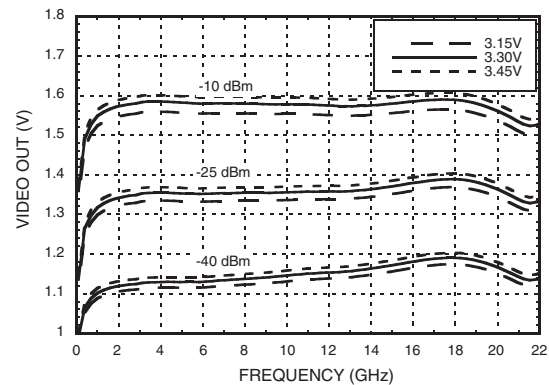

[1] Electrical Specs and performance plots are given for single-ended operation



SUCCESSIVE DETECTION LOG VIDEO AMPLIFIER (SDLVA), 0.6 - 20 GHz

Fall Time for Various Frequencies @ 0 dBm [1]

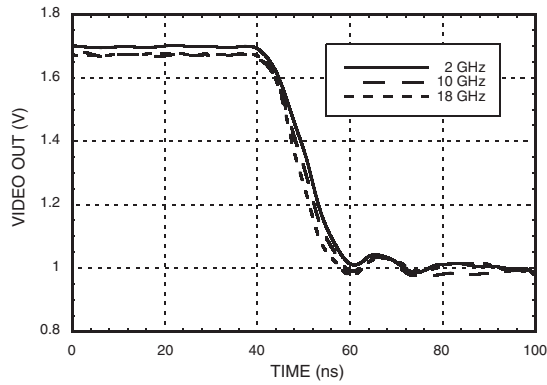

Rise Time for Various Frequencies @ 0 dBm [1]

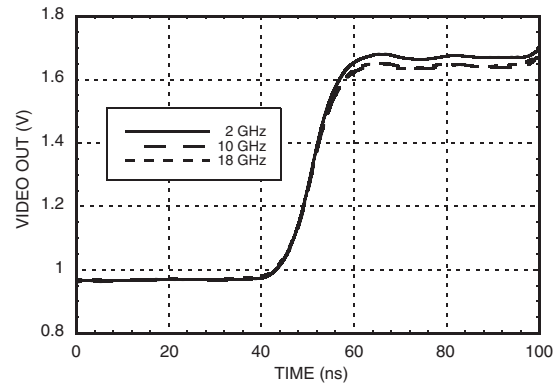

Input Return Loss vs. Frequency [1]

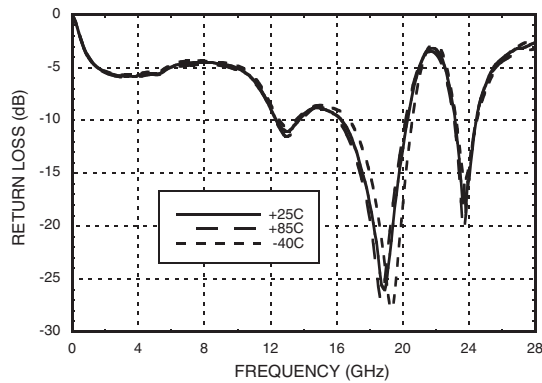

Absolute Maximum Ratings

Vcc	+3.6V
Enable	+3.6V
RF Input Power	+15 dBm
Junction Temperature	125 °C
Continuous Pdiss (T=85 °C) Derate 12.63 mW/°C above 85 °C	0.51 W
Thermal Resistance (R _{th}) (junction to package bottom)	79.2 °C/W
Storage Temperature	-65 to +150 °C
Operating Temperature	-40 to +85 °C
ESD Sensitivity (HBM)	Class 1A



**ELECTROSTATIC SENSITIVE DEVICE
OBSERVE HANDLING PRECAUTIONS**

[1] Electrical Specs and performance plots are given for single-ended operation

SUCCESSIVE DETECTION LOG VIDEO AMPLIFIER (SDLVA), 0.6 - 20 GHz

Outline Drawing

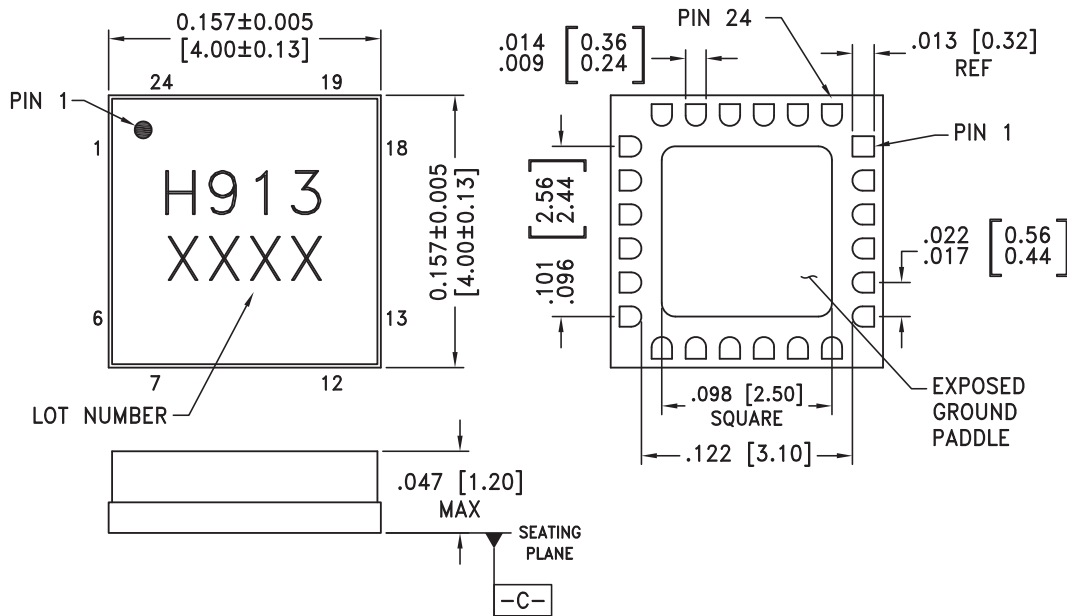

BOTTOM VIEW



NOTES:

1. PACKAGE BODY MATERIAL: ALUMINA
2. LEAD AND GROUND PADDLE PLATING: 30-80 MICROINCHES GOLD OVER 50 MICROINCHES MINIMUM NICKEL.
3. DIMENSIONS ARE IN INCHES [MILLIMETERS].
4. LEAD SPACING TOLERANCE IS NON-CUMULATIVE
5. PACKAGE WARP SHALL NOT EXCEED 0.05mm DATUM -C-
6. ALL GROUND LEADS AND GROUND PADDLE MUST BE SOLDERED TO PCB RF GROUND.
7. CLASSIFIED AS MOISTURE SENSITIVITY LEVEL (MSL) 1.

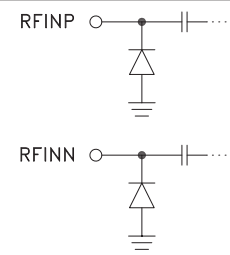
Pin Descriptions

Pin Number	Function	Description	Interface Schematic
1 - 3, 6, 7, 10 - 13, 16, 18 - 20, 24	N/C	The pins are not connected internally; however, all data shown herein was measured with these pins connected to RF/DC ground externally.	
4, 5	RFINP, RFINN	RF Input pins Connect RF to RFINP and AC couple RFINN to ground via 50 Ohm for single ended operation	
8, 9	GND	These pins and the exposed package bottom must be connected to a high quality RF/DC ground.	

Pin Descriptions

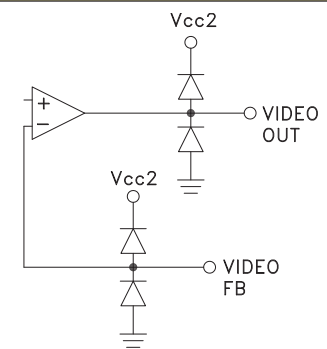
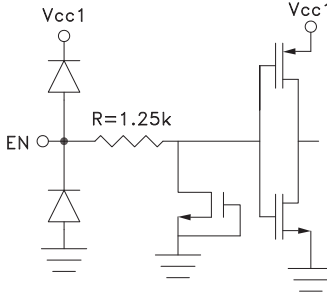
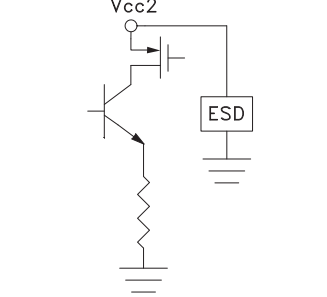
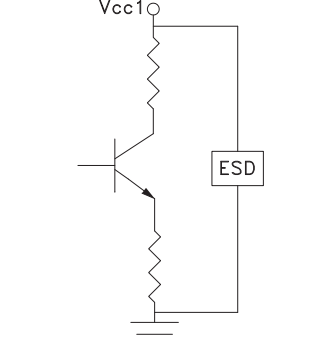
Pin Number	Function	Description	Interface Schematic
14, 15	VIDEO FB, VIDEO OUT	Video out and feedback.	
17	EN	Enable pin connected to Vcc1 or Vcc2 for normal operation. Total supply current reduced to less than 3mA when EN is set to 0V.	
21	Vcc2	Bias Supply. Connect supply voltage to these pins with appropriate filtering. Connect Vcc2 with Vcc1. See application circuit.	
22, 23	Vcc1	Bias Supply. Connect Supply Voltage to these pins with appropriate filtering. Connect Vcc2 with Vcc1. See application circuit.	



**SUCCESSIVE DETECTION LOG VIDEO
AMPLIFIER (SDLVA), 0.6 - 20 GHz**

Application Circuit

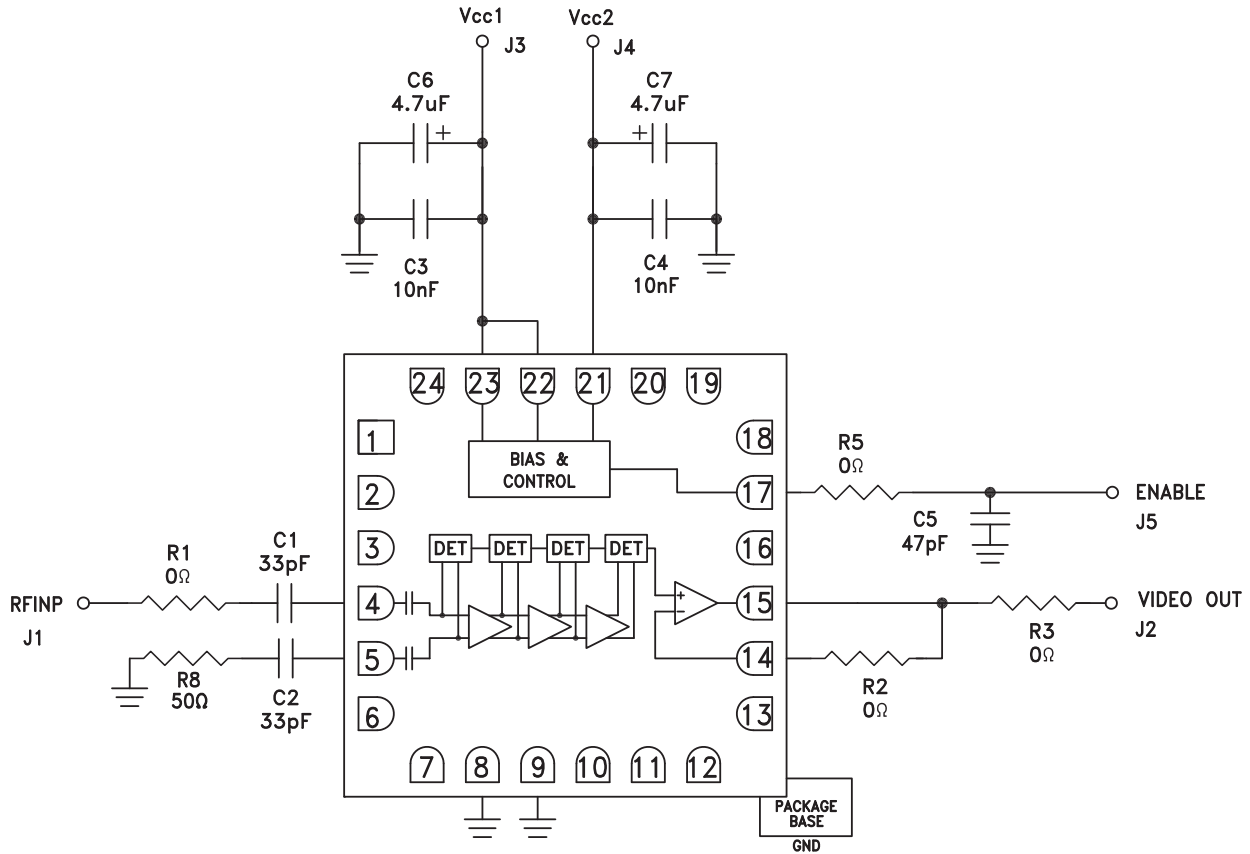

Note: Connect Vcc2 and Vcc1 together for Nominal operation.



Evaluation PCB

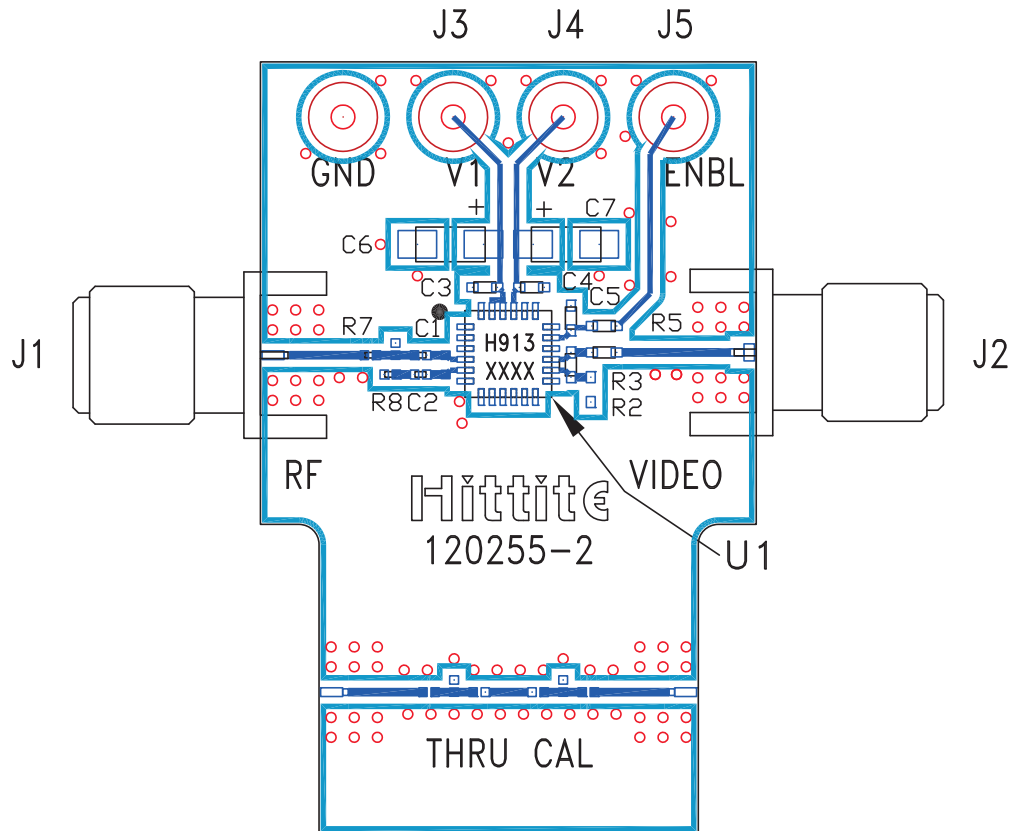

List of Materials for Evaluation PCB 120257 [1]

Item	Description
J1	K-Type Connector
J2	SMA Connector
J3 - J5	DC Pins
C1, C2	33 pF Capacitor, 0201 Pkg.
C3, C4	10k pF Capacitor, 0402 Pkg.
C5	47 pF Capacitor, 0402 Pkg.
C6, C7	4.7 μF Capacitor, CASE A Pkg.
R2, R3, R5	0 Ohm Resistor, 0402 Pkg.
R7	0 Ohm Resistor, 0201 Pkg.
R8	49.9 Ohm Resistor, 0201 Pkg.
U1	HMC913LC4B SDLVA
PCB [2]	120255 Evaluation PCB

[1] Reference this number when ordering complete evaluation PCB

[2] Circuit Board Material: Rogers 4350 or Arlon 25 FR

The circuit board used in the application should use RF circuit design techniques. Signal lines should have 50 ohm impedance while the package ground leads and exposed paddle should be connected directly to the ground plane similar to that shown. A sufficient number of via holes should be used to connect the top and bottom ground planes. The evaluation circuit board shown is available from Hittite upon request.



Компания «ЭлектроПласт» предлагает заключение долгосрочных отношений при поставках импортных электронных компонентов на взаимовыгодных условиях!

Наши преимущества:

- Оперативные поставки широкого спектра электронных компонентов отечественного и импортного производства напрямую от производителей и с крупнейших мировых складов;
- Поставка более 17-ти миллионов наименований электронных компонентов;
- Поставка сложных, дефицитных, либо снятых с производства позиций;
- Оперативные сроки поставки под заказ (от 5 рабочих дней);
- Экспресс доставка в любую точку России;
- Техническая поддержка проекта, помощь в подборе аналогов, поставка прототипов;
- Система менеджмента качества сертифицирована по Международному стандарту ISO 9001;
- Лицензия ФСБ на осуществление работ с использованием сведений, составляющих государственную тайну;
- Поставка специализированных компонентов (Xilinx, Altera, Analog Devices, Intersil, Interpoint, Microsemi, Aeroflex, Peregrine, Syfer, Eurofarad, Texas Instrument, Miteq, Cobham, E2V, MA-COM, Hittite, Mini-Circuits, General Dynamics и др.);

Помимо этого, одним из направлений компании «ЭлектроПласт» является направление «Источники питания». Мы предлагаем Вам помощь Конструкторского отдела:

- Подбор оптимального решения, техническое обоснование при выборе компонента;
- Подбор аналогов;
- Консультации по применению компонента;
- Поставка образцов и прототипов;
- Техническая поддержка проекта;
- Защита от снятия компонента с производства.



Как с нами связаться

Телефон: 8 (812) 309 58 32 (многоканальный)

Факс: 8 (812) 320-02-42

Электронная почта: org@eplast1.ru

Адрес: 198099, г. Санкт-Петербург, ул. Калинина, дом 2, корпус 4, литера А.