



### FEATURES

- Patents protected
- DC link voltage 1kVDC
- UL60950 recognised<sup>4</sup>
- ANSI/AAMI ES60601-1, 2 MOPP, 1MOPP recognised<sup>5</sup>
- 5.2kVDC Isolation 'Hi Pot Test'
- Substrate Embedded Transformer
- Automated Manufacture
- Short Circuit Protection<sup>3</sup>
- Halogen Free
- Operation to 95°C with derating
- Ultra low isolation capacitance 2pF

### PRODUCT OVERVIEW

The NXJ2 series is a new range of lower profile, fully automated manufacture surface mount DC-DC converters. The NXJ2 series automated manufacturing process with substrate Embedded Transformer, offers increased product reliability and repeatability of performance in a halogen free, iLGA inspectable package. The NXJ2 series, industry standard footprint is compatible with existing designs.

The NXJ2 series has a MSL rating 2, and is compatible with a peak reflow solder temperature of 260°C as per J-STD-020.

### SELECTION GUIDE

Order Code <sup>1</sup>	Nominal Input Voltage	Output Voltage	Rated Input Current	Output Current	Load Regulation (Typ)	Load Regulation (Max)	Output Ripple & Noise (Typ)	Output Ripple & Noise (Max)	Efficiency (Min)	Efficiency (Typ)	Switching Frequency (Typ)	Isolation Capacitance	MTTF <sup>2</sup>	
	V	V	mA	mA	%	%	mVp-p		%	%	kHz	pF	MIL 217	Telecordia
													kHrs	
<b>NXJ2S0505MC</b>	5	5	550	400	7.5	10	50	110	68.5	72.5	140	2	2874	40967
<b>NXJ2S1212MC</b>	12	12	215	167	7	9	30	70	72	75	120	2	1766	65080
<b>NXJ2S1215MC</b>	12	15	215	133	8	10	25	60	75	77.5	110	2.2	1334	49049
<b>NXJ2S2405MC</b>	24	5	110	400	8	10	70	170	73	76.5	100	2.4	2026	33111
<b>NXJ2S2415MC</b>	24	15	105	133	6.5	8	20	50	74.5	78.5	95	2.4	1232	44260

### INPUT CHARACTERISTICS

Parameter	Conditions	Min.	Typ.	Max.	Units
Voltage range	Continuous operation, 5V input types	4.5	5.0	5.5	V
	Continuous operation, 12V input types	10.8	12	13.2	
	Continuous operation, 24V input types	21.6	24	26.4	
Input reflected ripple current	5V input		15		mA p-p
	12V & 24V input		5		

### ISOLATION CHARACTERISTICS

Parameter	Conditions	Min.	Typ.	Max.	Units
Isolation voltage	Production tested for 1 second	5200			VDC
	Qualification tested for 1 minute	5200			
Resistance	Viso= 1000VDC	10			GΩ

### OUTPUT CHARACTERISTICS

Parameter	Conditions	Min.	Typ.	Max.	Units	
Rated power	T <sub>A</sub> =-40°C to 85°C			2.0	W	
Voltage set point accuracy	See tolerance envelope					
Line regulation	High V <sub>IN</sub> to low V <sub>IN</sub>	24V input types		1	1.1	%/%
		All other input types		1.1	1.2	

### TEMPERATURE CHARACTERISTICS

Parameter	Conditions	Min.	Typ.	Max.	Units
Specification	All output types	-40		85	°C
Storage		-50		125	
Product temperature rise above ambient	5V input types		35		°C
	12V input types		30		
	24V input types		25		
Cooling	Free air convection				

### ABSOLUTE MAXIMUM RATINGS

Input voltage V <sub>IN</sub> , NXJ2S05 types	7V
Input voltage V <sub>IN</sub> , NXJ2S12 types	15V
Input voltage V <sub>IN</sub> , NXJ2S24 types	28V

- Components are supplied in tape and reel packaging, please refer to package specification section. Orderable part numbers are NXJ2SXXXXMC-R7 (135 pieces per reel), or NXJ2SXXXXMC-R13 (600 pieces per reel).
- Calculated using MIL-HDBK-217 FN2 and Telecordia SR-332 calculation model at T<sub>A</sub>=25°C with nominal input voltage at full load.
- Please refer to short circuit application notes.
- UL60950 recognition is currently pending for NXJ2S2405MC and NXJ2S2415MC.
- ANSI/AAMI ES60601-1 recognition is currently pending for NXJ2S2405MC and NXJ2S2415MC.

All specifications typical at T<sub>A</sub>=25°C, nominal input voltage and rated output current unless otherwise specified.



For full details go to [www.murata-ps.com/rohs](http://www.murata-ps.com/rohs)

**TECHNICAL NOTES**

**ISOLATION VOLTAGE**

'Hi Pot Test', 'Flash Tested', 'Withstand Voltage', 'Proof Voltage', 'Dielectric Withstand Voltage' & 'Isolation Test Voltage' are all terms that relate to the same thing, a test voltage, applied for a specified time, across a component designed to provide electrical isolation, to verify the integrity of that isolation.

Murata Power Solutions NXJ2 series of DC-DC converters are all 100% production tested at 5.2kVDC for 1 second and have been qualification tested at 5.2kVDC for 1 minute.

The NXJ2 series is recognised by Underwriters Laboratory, please see safety approval section for more information. When the insulation in the NXJ2 series is not used as a safety barrier, i.e. provides functional isolation only, continuous or switched voltages across the barrier up to 1kV are sustainable. This is established by measuring the partial discharge inception voltage in accordance with IEC 60270. Please contact Murata for further information.

**REPEATED HIGH-VOLTAGE ISOLATION TESTING**

It is well known that repeated high-voltage isolation testing of a barrier component can actually degrade isolation capability, to a lesser or greater degree depending on materials, construction and environment. The NXJ2 series has a PCB embedded isolated transformer, using FR4 as an insulation barrier between primary and secondary windings. While parts can be expected to withstand several times the stated test voltage, the isolation capability does depend on the FR4 insulation properties. Any material, including FR4 is susceptible to eventual chemical degradation when subject to very high applied voltages thus implying that the number of tests should be strictly limited. We therefore strongly advise against repeated high voltage isolation testing, but if it is absolutely required, that the voltage should be reduced by 20% from specified test voltage.

This consideration equally applies to agency recognized parts rated for better than functional isolation where the insulation is always supplemented by a further insulation system of physical spacing or barriers.

**SAFETY APPROVAL**

**ANSI/AAMI ES60601-1**

The NXJ2 series is recognised by Underwriters Laboratory (UL) to ANSI/AAMI ES60601-1 and provides 1 MOPP (Means Of Patient Protection) and 2 MOOP (Means Of Operator Protection) based upon a working voltage of 250 Vrms max, between input and output. The NXJ2S2405MC and NXJ2S2415MC are currently pending recognition.

**UL60950**

The NXJ2 series is recognised by Underwriters Laboratory (UL) to UL60950 for reinforced insulation to a working voltage of 250Vrms. The NXJ2S2405MC and NXJ2S2415MC are currently pending recognition.

Creepage and clearance 5mm.

Working altitude 3000m

Over voltage category (OVC) II

**FUSING**

The NXJ2 Series of converters are not internally fused so to meet the requirements of UL an anti-surge input line fuse should always be used with ratings as defined below.

Input Voltage, 5V: 1A

Input Voltage, 12V: 500mA

Input Voltage, 24V: 250mA

All fuses should be UL recognized and rated to at least the maximum allowable DC input voltage.

**RoHS COMPLIANCE AND MSL INFORMATION**



This series is compatible with Pb-Free soldering systems and is also backward compatible with Sn/Pb soldering systems.

The NXJ2 series can be soldered in accordance with J-STD-020 and have a classification temperature of 260°C and moisture sensitivity level 2. The termination finish on this product is Gold with plating thickness 0.12 microns.



**APPLICATION NOTES**

**Short Circuit Performance**

The NXJ2 series short circuit performance is currently being evaluated. Please contact Murata for further information.

**Gate Drive Applications Advisory Note**

For general guidance for product usage in gate drive applications please refer to [“gate drive application notes”](#).

**Advisory Notes**

The NXJ2 series is not hermetically sealed, customers should ensure that parts are fully dried before input power application.

**Minimum Load**

The minimum load to meet datasheet specification is 10% of the full rated load across the specified input voltage range. Lower than 10% minimum loading will result in an increase in output voltage, which may rise to typically double the specified output voltage if the output load falls to less than 5%.

**Capacitive Loading & Start Up**

Typical start up times for this series, with a typical input voltage rise time of 2.2µs with resistive only load, and with added output capacitance of 10µF, are shown in the table below.

Part Number	Start-Up Time	
	µS	
NXJ2S0505MC	260	
NXJ2S1212MC	840	
NXJ2S1215MC	1200	
NXJ2S2405MC	160	
NXJ2S2415MC	1110	

Typical Start-Up Wave Form

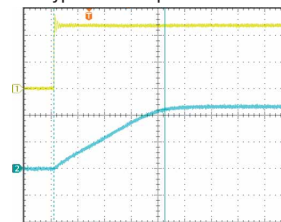

**Output Ripple Reduction**

By using the values of inductance and capacitance stated, the output ripple at the rated load is lowered to 5mV p-p max.

**Component selection**

**Capacitor:** It is required that the ESR (Equivalent Series Resistance) should be as low as possible, ceramic types are recommended. The voltage rating should be at least twice (except for 15V output), the rated output voltage of the DC-DC converter.

**Inductor:** The rated current of the inductor should not be less than that of the output of the DC-DC converter. At the rated current, the DC resistance of the inductor should be such that the voltage drop across the inductor is <2% of the rated voltage of the DC-DC converter. The SRF (Self Resonant Frequency) should be >20MHz.

	Inductor			Capacitor C, µF
	L, µH	SMD	Through Hole	
NXJ2S0505MC	4.7	82472C	11R472C	10
NXJ2S1212MC	4.7	82472C	11R472C	4.7
NXJ2S1215MC	4.7	82472C	11R472C	4.7
NXJ2S2405MC	4.7	82472C	11R472C	10
NXJ2S2415MC	4.7	82472C	11R472C	4.7

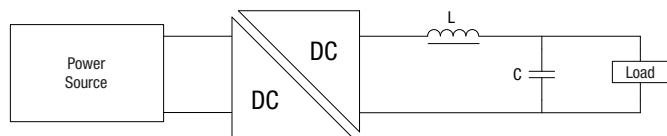

**TOLERANCE ENVELOPES**

The voltage tolerance envelope shows typical load regulation characteristics for this product series. The tolerance envelope is the maximum output voltage variation due to changes in output loading.

**NXJ2S0505MC**

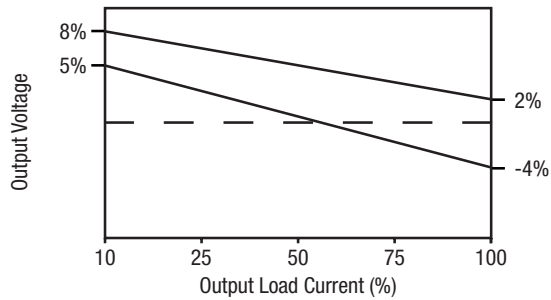

**NXJ2S1212MC**

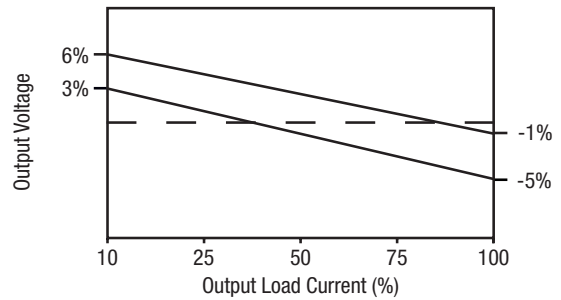

**NXJ2S1215MC**

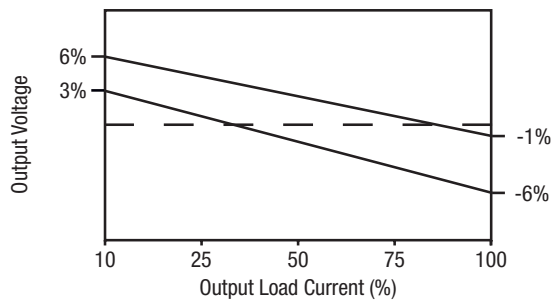

**NXJ2S2405MC**

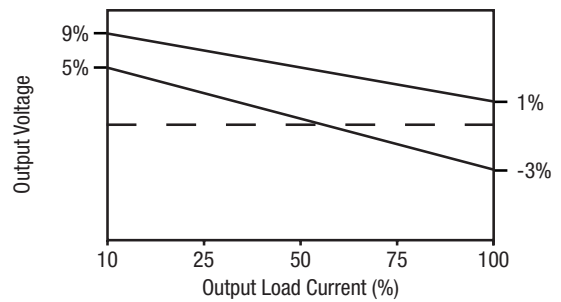

**NXJ2S2415MC**

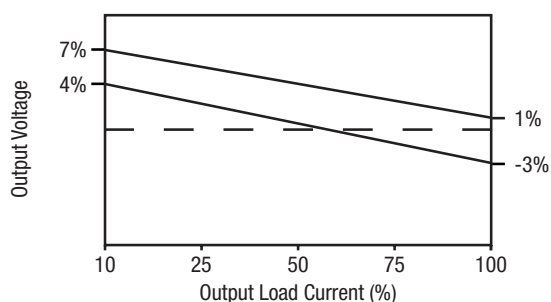

## EFFICIENCY VS LOAD

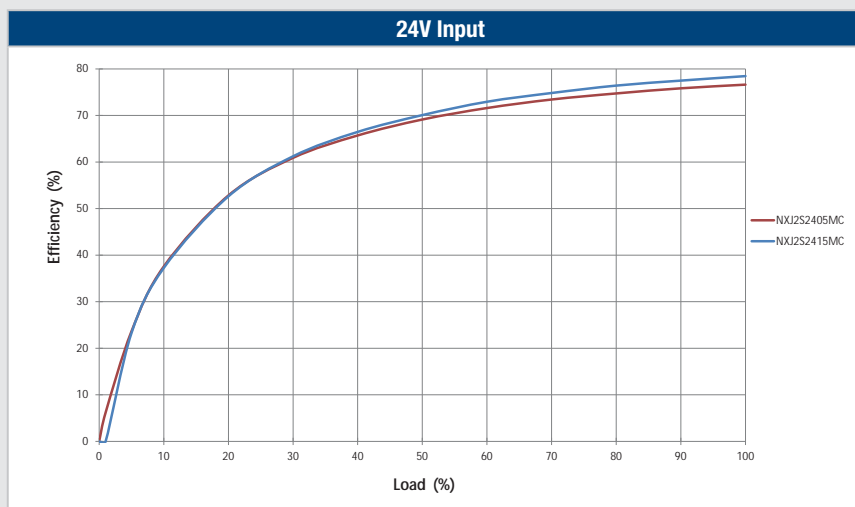
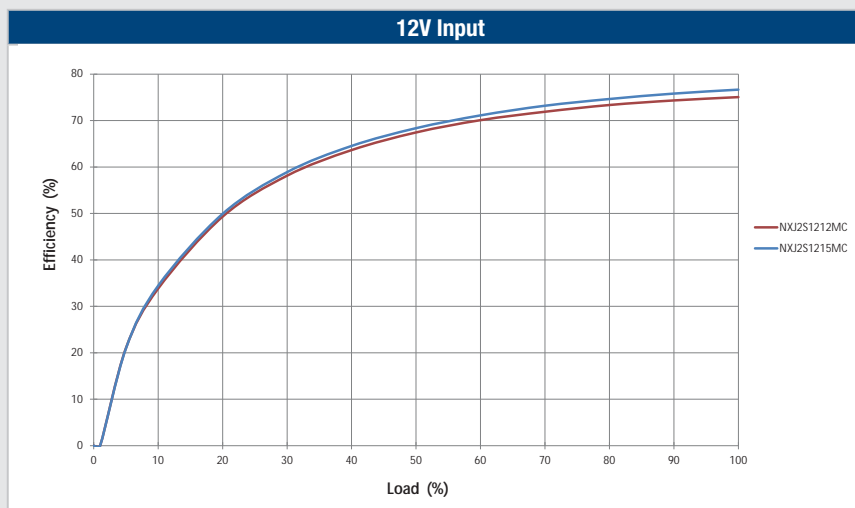
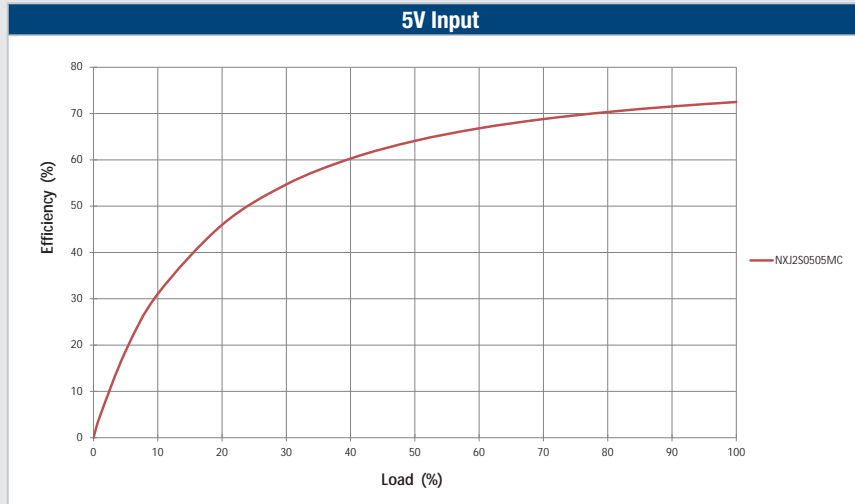

**TEMPERATURE DERATING**

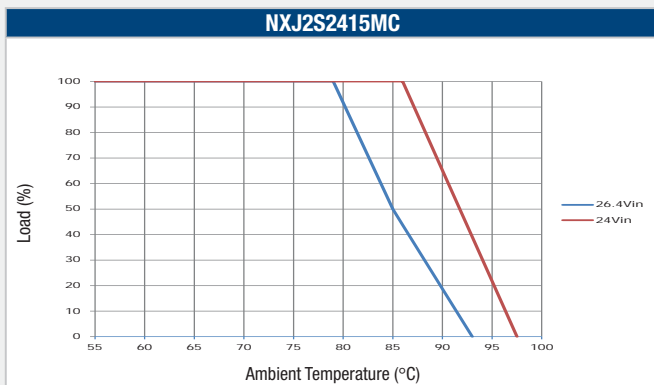
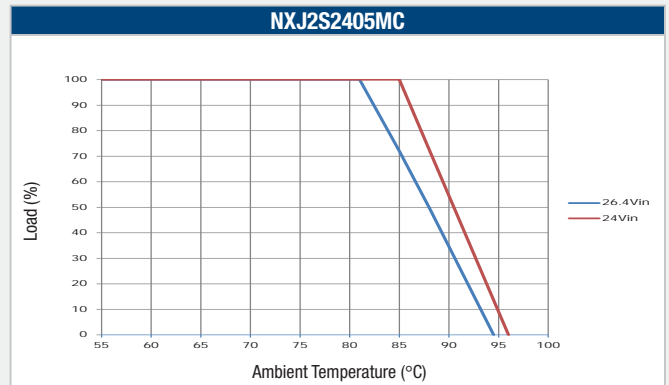
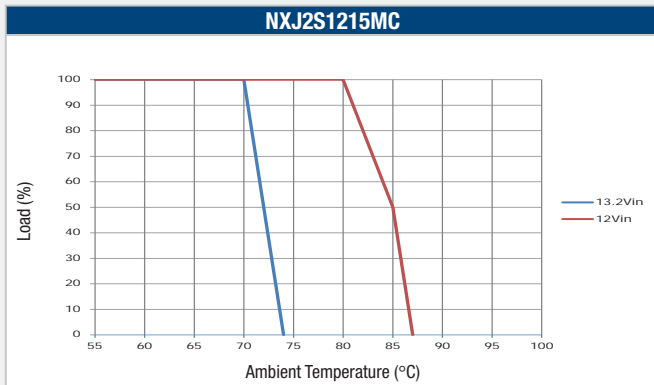
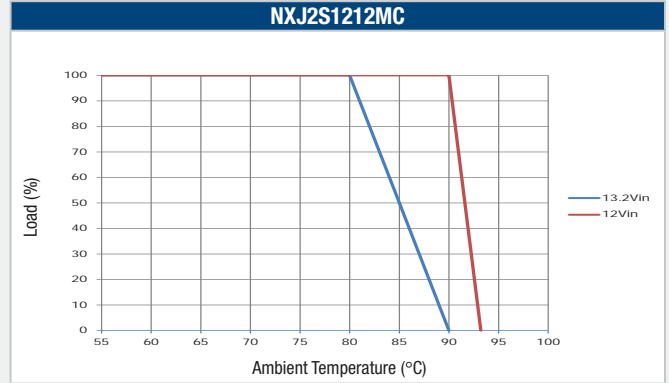
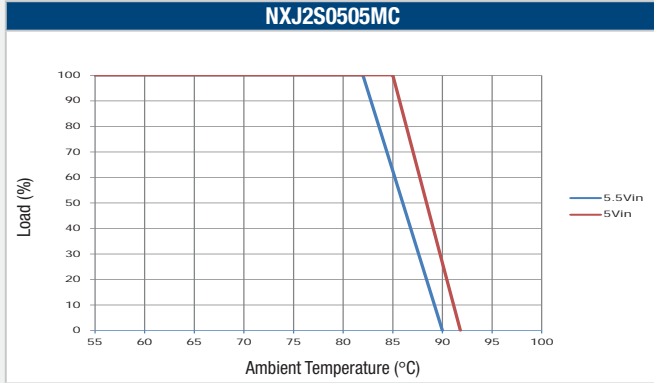

**EMC FILTERING AND SPECTRA**

**FILTERING**

The following table shows the additional input capacitor and input inductor typically required to meet EN 55022 Curve A & B CISPR22 Average Limit as shown in the following plots. The following plots show positive and negative average limit and CISPR22 Average Limit A (pink line) and CISPR22 Average Limit B (green line) adherence limits. The below values are for guidance only and should be evaluated in the application circuit.

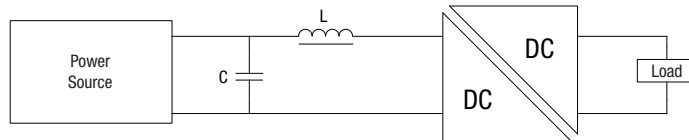

	Inductor			Capacitor	
	L, $\mu$ H	SMD	Through Hole	C, $\mu$ F	SMD
NXJ2S0505MC	10	84103C	11R103C	15	GRM55ER71E156KA01
NXJ2S1212MC	10	82103C	11R103C	15	GRM55ER71E156KA01
NXJ2S1215MC	10	82103C	11R103C	15	GRM55ER71E156KA01
NXJ2S2405MC	10	82103C	11R103C	15	KRM55LR7YA156KH01
NXJ2S2415MC	10	82103C	11R103C	15	KRM55LR7YA156KH01

**NXJ2S0505MC (Quasi Peak)**

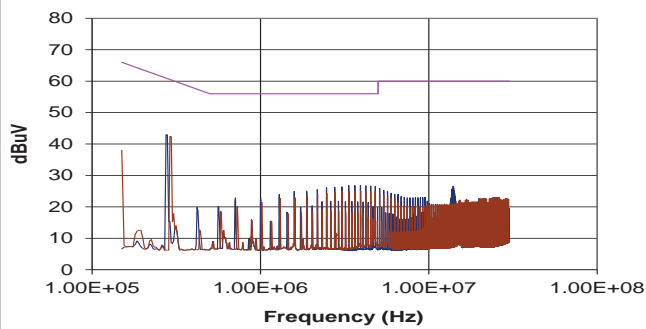

**NXJ2S0505MC (Average)**

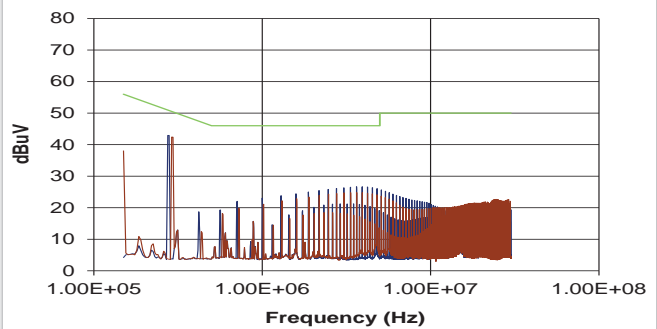

**NXJ2S1212MC (Quasi Peak)**

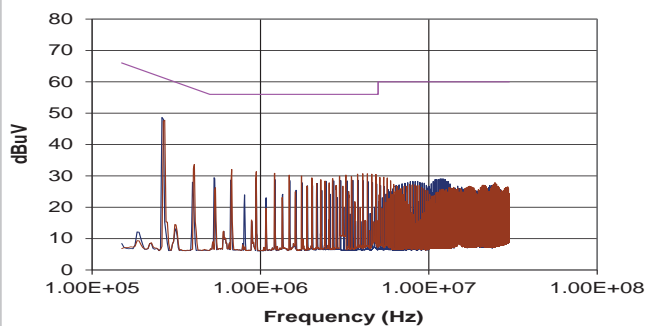

**NXJ2S1212MC (Average)**

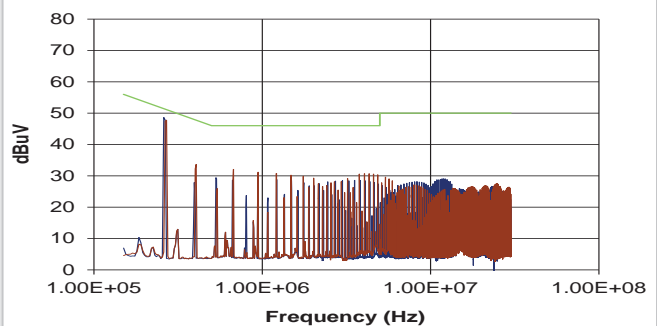



**EMC FILTERING AND SPECTRA**

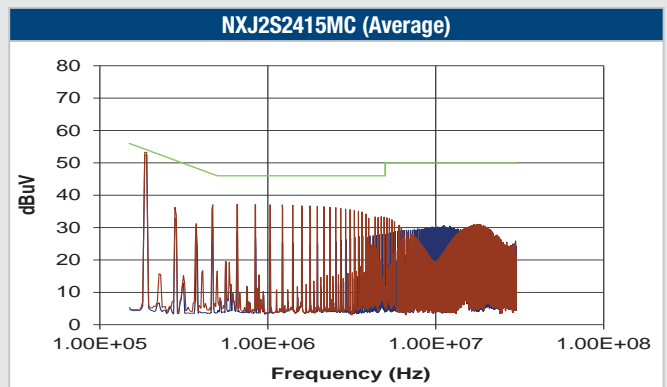
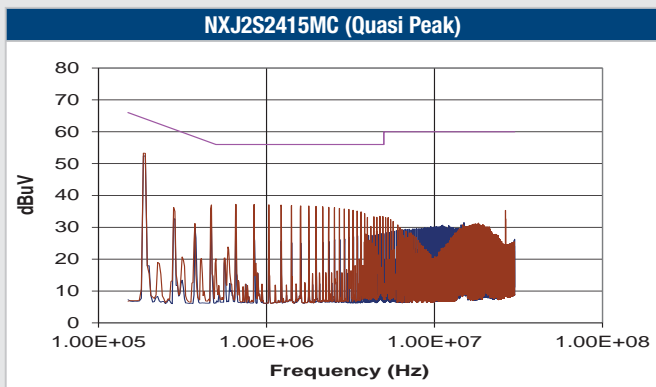
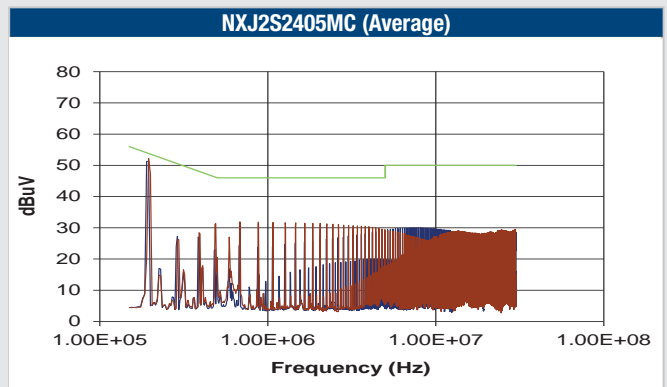
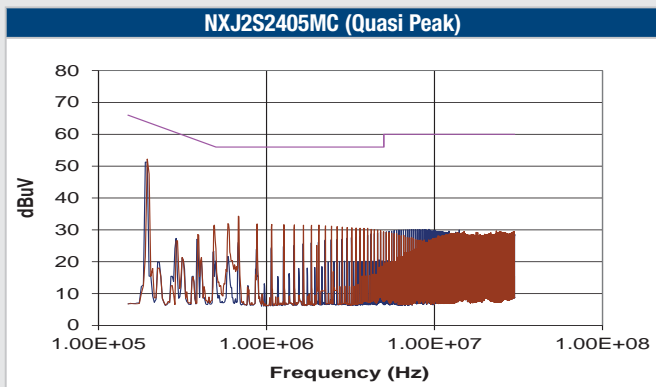
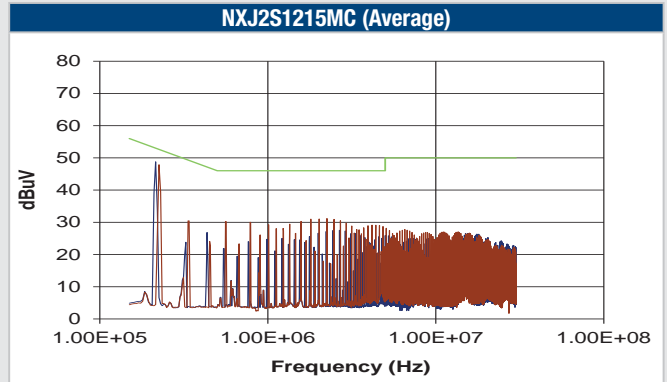
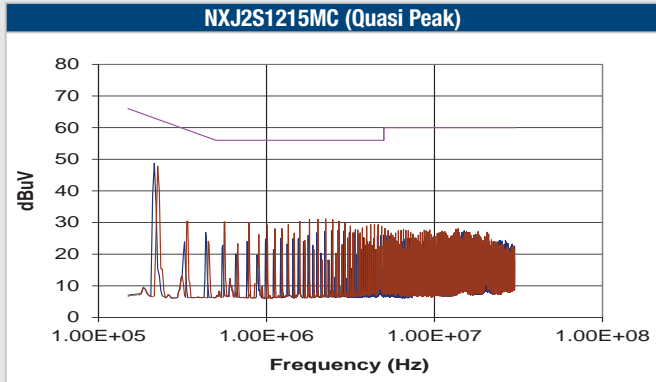

**PACKAGE SPECIFICATIONS**

Mechanical Dimensions - 5V & 12V Input Types

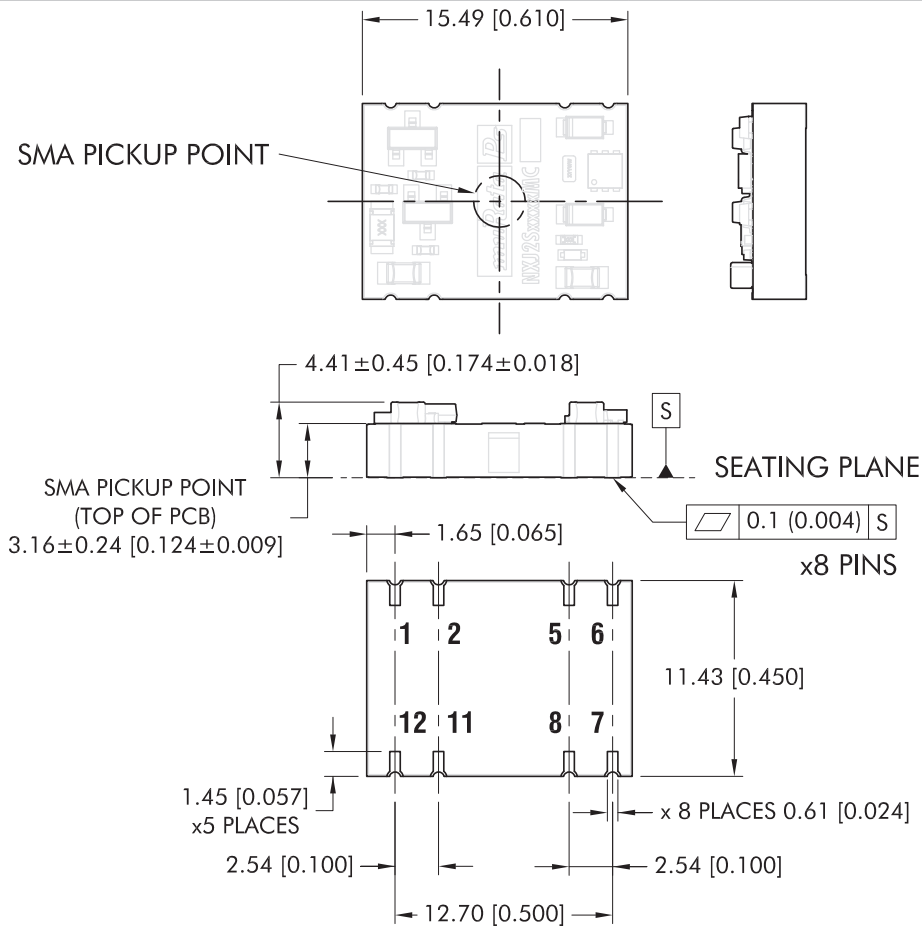

All dimensions in mm(inches). Controlling dimension is mm. Tolerances (unless otherwise stated) ±0.2 (0.008). Components shown for reference only

Weight: 1.38g

Pin Connections

Pin	Function
1	+VIN
2	-VIN
5	-VOUT
6	+VOUT
7	NC
8	NC
11	-VIN
12	NC

NC - No connection.

Recommended Footprint Details

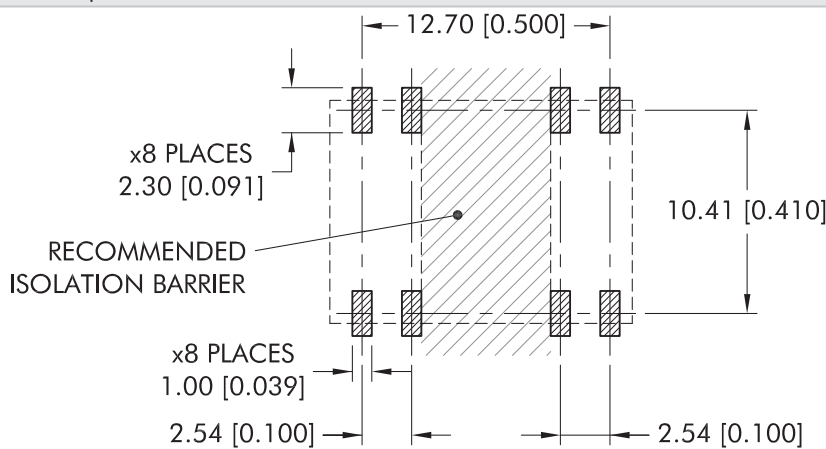



**TAPE & REEL SPECIFICATIONS**

**TAPE OUTLINE DIMENSIONS - 5V & 12V Input Types**

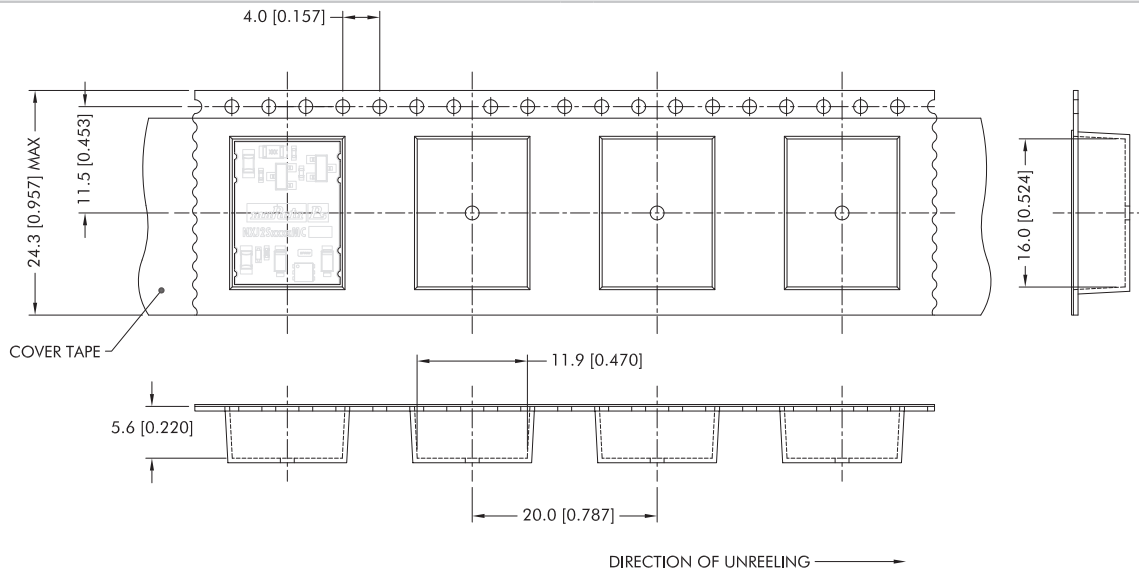

Tape & Reel specifications shall conform with current EIA-481 standard  
 Unless otherwise stated all dimensions in mm(inches)  
 Controlling dimension is mm  
 Components shall be orientated within the carrier tape as indicated

**TAPE OUTLINE DIMENSIONS - 24V Input Type**

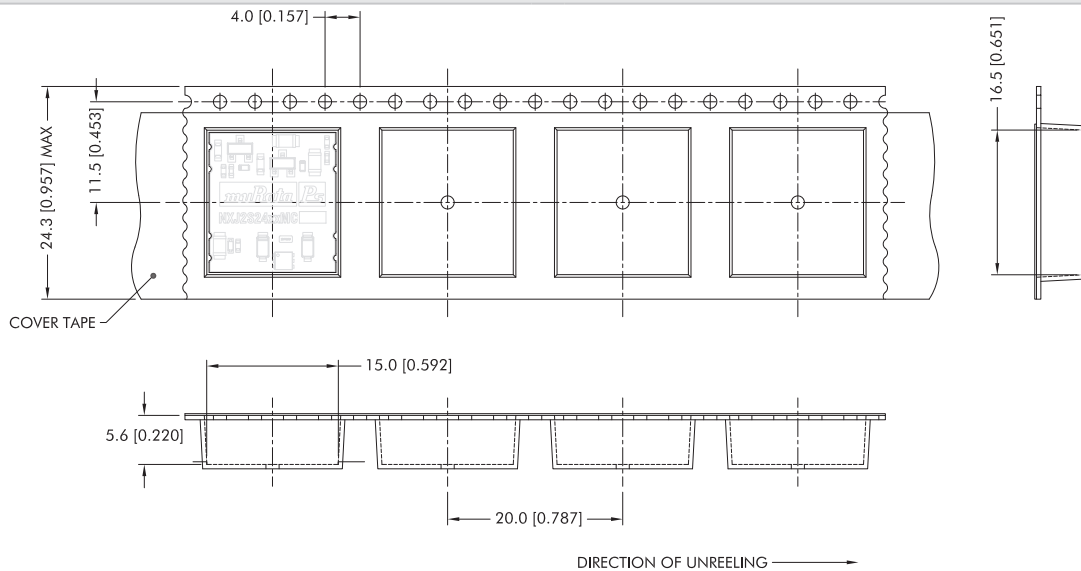

Tape & Reel specifications shall conform with current EIA-481 standard  
 Unless otherwise stated all dimensions in mm(inches)  
 Controlling dimension is mm  
 Components shall be orientated within the carrier tape as indicated

**TAPE & REEL SPECIFICATIONS CONTINUED**

**REEL OUTLINE DIMENSIONS**

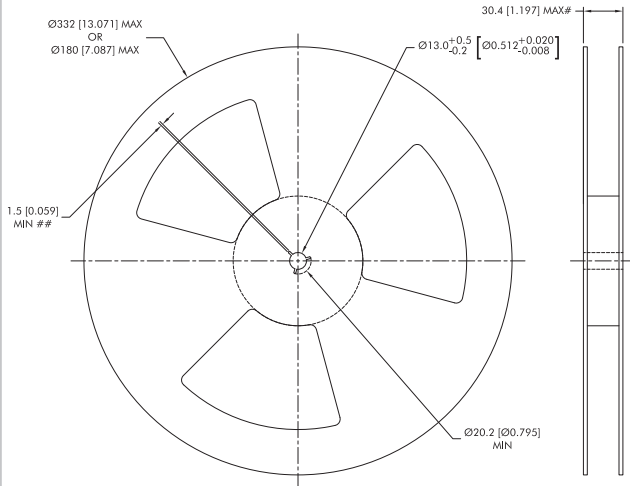

Tape & Reel specifications shall conform with current EIA-481 standard  
 Unless otherwise stated all dimensions in mm(inches)  
 Controlling dimension is mm  
 # Measured at hub  
 ## Six equi-spaced slots on 180mm/7" reel

**REEL PACKAGING DETAILS**

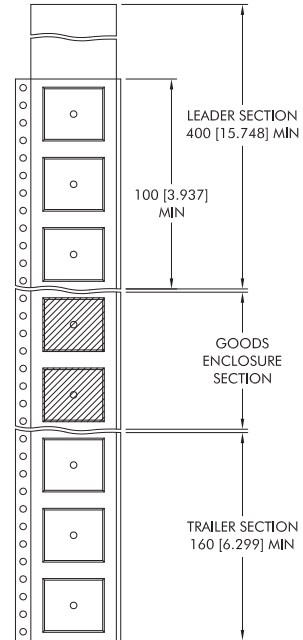

Carrier tape pockets shown are illustrative only - Refer to carrier tape diagram for actual pocket details.

Reel Quantity: 7" - 135 or 13" - 600



This product is subject to the following **operating requirements** and the **Life and Safety Critical Application Sales Policy**:  
 Refer to: <http://www.murata-ps.com/requirements/>

Murata Power Solutions, Inc. makes no representation that the use of its products in the circuits described herein, or the use of other technical information contained herein, will not infringe upon existing or future patent rights. The descriptions contained herein do not imply the granting of licenses to make, use, or sell equipment constructed in accordance therewith. Specifications are subject to change without notice. © 2019 Murata Power Solutions, Inc.

# Mouser Electronics

Authorized Distributor

Click to View Pricing, Inventory, Delivery & Lifecycle Information:

## Murata:

[NXJ2S2415MC-R7](#) [NXJ2S0505MC-R13](#) [NXJ2S0505MC-R7](#) [NXJ2S1212MC-R7](#) [NXJ2S2405MC-R7](#)  
[NXJ2S1212MC-R13](#) [NXJ2S1215MC-R13](#) [NXJ2S1215MC-R7](#) [NXJ2S2405MC-R13](#) [NXJ2S2415MC-R13](#)



Компания «ЭлектроПласт» предлагает заключение долгосрочных отношений при поставках импортных электронных компонентов на взаимовыгодных условиях!

Наши преимущества:

- Оперативные поставки широкого спектра электронных компонентов отечественного и импортного производства напрямую от производителей и с крупнейших мировых складов;
- Поставка более 17-ти миллионов наименований электронных компонентов;
- Поставка сложных, дефицитных, либо снятых с производства позиций;
- Оперативные сроки поставки под заказ (от 5 рабочих дней);
- Экспресс доставка в любую точку России;
- Техническая поддержка проекта, помощь в подборе аналогов, поставка прототипов;
- Система менеджмента качества сертифицирована по Международному стандарту ISO 9001;
- Лицензия ФСБ на осуществление работ с использованием сведений, составляющих государственную тайну;
- Поставка специализированных компонентов (Xilinx, Altera, Analog Devices, Intersil, Interpoint, Microsemi, Aeroflex, Peregrine, Syfer, Eurofarad, Texas Instrument, Miteq, Cobham, E2V, MA-COM, Hittite, Mini-Circuits, General Dynamics и др.);

Помимо этого, одним из направлений компании «ЭлектроПласт» является направление «Источники питания». Мы предлагаем Вам помощь Конструкторского отдела:

- Подбор оптимального решения, техническое обоснование при выборе компонента;
- Подбор аналогов;
- Консультации по применению компонента;
- Поставка образцов и прототипов;
- Техническая поддержка проекта;
- Защита от снятия компонента с производства.



#### Как с нами связаться

**Телефон:** 8 (812) 309 58 32 (многоканальный)

**Факс:** 8 (812) 320-02-42

**Электронная почта:** [org@eplast1.ru](mailto:org@eplast1.ru)

**Адрес:** 198099, г. Санкт-Петербург, ул. Калинина, дом 2, корпус 4, литера А.