



Is Now Part of



**ON Semiconductor®**

To learn more about ON Semiconductor, please visit our website at  
[www.onsemi.com](http://www.onsemi.com)

Please note: As part of the Fairchild Semiconductor integration, some of the Fairchild orderable part numbers will need to change in order to meet ON Semiconductor's system requirements. Since the ON Semiconductor product management systems do not have the ability to manage part nomenclature that utilizes an underscore (\_), the underscore (\_) in the Fairchild part numbers will be changed to a dash (-). This document may contain device numbers with an underscore (\_). Please check the ON Semiconductor website to verify the updated device numbers. The most current and up-to-date ordering information can be found at [www.onsemi.com](http://www.onsemi.com). Please email any questions regarding the system integration to [Fairchild\\_questions@onsemi.com](mailto:Fairchild_questions@onsemi.com).

ON Semiconductor and the ON Semiconductor logo are trademarks of Semiconductor Components Industries, LLC dba ON Semiconductor or its subsidiaries in the United States and/or other countries. ON Semiconductor owns the rights to a number of patents, trademarks, copyrights, trade secrets, and other intellectual property. A listing of ON Semiconductor's product/patent coverage may be accessed at [www.onsemi.com/site/pdf/Patent-Marking.pdf](http://www.onsemi.com/site/pdf/Patent-Marking.pdf). ON Semiconductor reserves the right to make changes without further notice to any products herein. ON Semiconductor makes no warranty, representation or guarantee regarding the suitability of its products for any particular purpose, nor does ON Semiconductor assume any liability arising out of the application or use of any product or circuit, and specifically disclaims any and all liability, including without limitation special, consequential or incidental damages. Buyer is responsible for its products and applications using ON Semiconductor products, including compliance with all laws, regulations and safety requirements or standards, regardless of any support or applications information provided by ON Semiconductor. "Typical" parameters which may be provided in ON Semiconductor data sheets and/or specifications can and do vary in different applications and actual performance may vary over time. All operating parameters, including "Typicals" must be validated for each customer application by customer's technical experts. ON Semiconductor does not convey any license under its patent rights nor the rights of others. ON Semiconductor products are not designed, intended, or authorized for use as a critical component in life support systems or any FDA Class 3 medical devices or medical devices with a same or similar classification in a foreign jurisdiction or any devices intended for implantation in the human body. Should Buyer purchase or use ON Semiconductor products for any such unintended or unauthorized application, Buyer shall indemnify and hold ON Semiconductor and its officers, employees, subsidiaries, affiliates, and distributors harmless against all claims, costs, damages, and expenses, and reasonable attorney fees arising out of, directly or indirectly, any claim of personal injury or death associated with such unintended or unauthorized use, even if such claim alleges that ON Semiconductor was negligent regarding the design or manufacture of the part. ON Semiconductor is an Equal Opportunity/Affirmative Action Employer. This literature is subject to all applicable copyright laws and is not for resale in any manner.



September 2015

# FDN5632N\_F085

## N-Channel Logic Level PowerTrench<sup>®</sup> MOSFET

60 V, 1.6 A, 98 mΩ

### Features

- $R_{DS(on)} = 98\text{ m}\Omega$  at  $V_{GS} = 4.5\text{ V}$ ,  $I_D = 1.6\text{ A}$
- $R_{DS(on)} = 82\text{ m}\Omega$  at  $V_{GS} = 10\text{ V}$ ,  $I_D = 1.7\text{ A}$
- Typ  $Q_{g(TOT)} = 9.2\text{ nC}$  at  $V_{GS} = 10\text{ V}$
- Low Miller Charge
- UIS Capability
- Qualified to AEC Q101
- RoHS Compliant

### Applications

- DC/DC converter
- Motor Drives

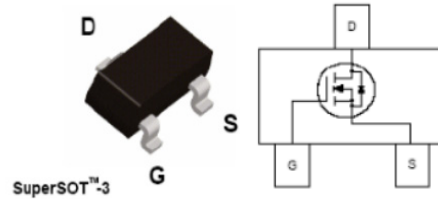

### MOSFET Maximum Ratings $T_A = 25^\circ\text{C}$ unless otherwise noted

Symbol	Parameter	Ratings	Units
$V_{DSS}$	Drain to Source Voltage	60	V
$V_{GS}$	Gate to Source Voltage	$\pm 20$	V
$I_D$	Drain Current Continuous ( $V_{GS} = 10\text{V}$ )	1.7	A
	Pulsed	10	
$E_{AS}$	Single Pulse Avalanche Energy (Note 1)	74	mJ
$P_D$	Power Dissipation	1.1	W
$T_J, T_{STG}$	Operating and Storage Temperature	-55 to +150	$^\circ\text{C}$
$R_{\theta JC}$	Thermal Resistance Junction to Case	75	$^\circ\text{C/W}$
$R_{\theta JA}$	Thermal Resistance Junction to Ambient TO-252, 1in <sup>2</sup> copper pad area	111	$^\circ\text{C/W}$

**Note:**

1:  $E_{AS}$  of 74mJ is 100% test at  $L=80\text{mH}$ ,  $I_{AS}=1.4\text{A}$ , starting  $T_J = 25^\circ\text{C}$

### Package Marking and Ordering Information

Device Marking	Device	Package	Reel Size	Tape Width	Quantity
5632	FDN5632N_F085	SSOT3	7"	8mm	3000 units

F DN5632N\_F085 N-Channel Logic Level PowerTrench<sup>®</sup> MOSFET

**Electrical Characteristics**  $T_A = 25^\circ\text{C}$  unless otherwise noted

Symbol	Parameter	Test Conditions	Min	Typ	Max	Units
--------	-----------	-----------------	-----	-----	-----	-------

**Off Characteristics**

$B_{VDSS}$	Drain to Source Breakdown Voltage	$I_D = 250\mu\text{A}, V_{GS} = 0\text{V}$	60	-	-	V
$I_{DSS}$	Zero Gate Voltage Drain Current	$V_{DS} = 48\text{V},$ $V_{GS} = 0\text{V}$	-	-	1	$\mu\text{A}$
		$T_A = 125^\circ\text{C}$	-	-	250	
$I_{GSS}$	Gate to Source Leakage Current	$V_{GS} = \pm 20\text{V}$	-	-	$\pm 100$	nA

**On Characteristics**

$V_{GS(th)}$	Gate to Source Threshold Voltage	$V_{GS} = V_{DS}, I_D = 250\mu\text{A}$	1	2.0	3	V
$r_{DS(on)}$	Drain to Source On Resistance	$I_D = 1.7\text{A}, V_{GS} = 10\text{V}$	-	57	82	m $\Omega$
		$I_D = 1.6\text{A}, V_{GS} = 6\text{V}$	-	62	88	
		$I_D = 1.6\text{A}, V_{GS} = 4.5\text{V}$	-	70	98	
		$I_D = 1.7\text{A}, V_{GS} = 10\text{V},$ $T_A = 150^\circ\text{C}$	-	107	135	

**Dynamic Characteristics**

$C_{iss}$	Input Capacitance	$V_{DS} = 15\text{V}, V_{GS} = 0\text{V},$ $f = 1\text{MHz}$	-	475	-	pF	
$C_{oss}$	Output Capacitance		-	60	-	pF	
$C_{rss}$	Reverse Transfer Capacitance		-	30	-	pF	
$R_G$	Gate Resistance	$f = 1\text{MHz}$	-	1.4	-	$\Omega$	
$Q_{g(TOT)}$	Total Gate Charge at 10V	$V_{GS} = 0$ to 10V	$V_{DD} = 20\text{V}$ $I_D = 1.7\text{A}$	-	9.2	12	nC
$Q_{gs}$	Gate to Source Gate Charge			-	1.5	-	nC
$Q_{gd}$	Gate to Drain "Miller" Charge			-	1.4	-	nC

**Electrical Characteristics**  $T_A = 25^\circ\text{C}$  unless otherwise noted

Symbol	Parameter	Test Conditions	Min	Typ	Max	Units
--------	-----------	-----------------	-----	-----	-----	-------

**Switching Characteristics**

$t_{on}$	Turn-On Time	$V_{DD} = 30\text{V}, I_D = 1.0\text{A}$ $V_{GS} = 10\text{V}, R_{GEN} = 6\Omega$	-	-	30	ns
$t_{d(on)}$	Turn-On Delay Time		-	15	-	ns
$t_r$	Rise Time		-	1.7	-	ns
$t_{d(off)}$	Turn-Off Delay Time		-	5.2	-	ns
$t_f$	Fall Time		-	1.3	-	ns
$t_{off}$	Turn-Off Time		-	-	12.9	ns

**Drain-Source Diode Characteristics**

$V_{SD}$	Source to Drain Diode Voltage	$I_{SD} = 1.7\text{A}$	-	0.8	1.25	V
		$I_{SD} = 0.85\text{A}$	-	0.8	1.0	
$t_{rr}$	Reverse Recovery Time	$I_{SD} = 1.7\text{A}, dI_{SD}/dt = 100\text{A}/\mu\text{s}$	-	16.0	21	ns
$Q_{rr}$	Reverse Recovery Charge		-	7.9	10.3	nC

### Typical Characteristics

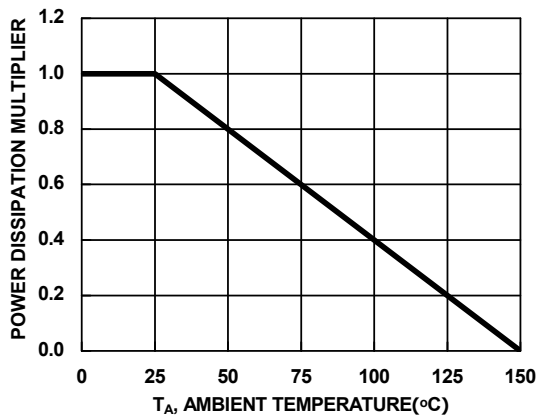

Figure 1. Normalized Power Dissipation vs. Case Temperature

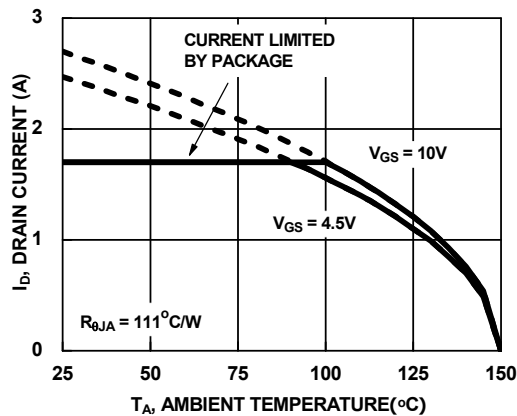

Figure 2. Maximum Continuous Drain Current vs. Case Temperature

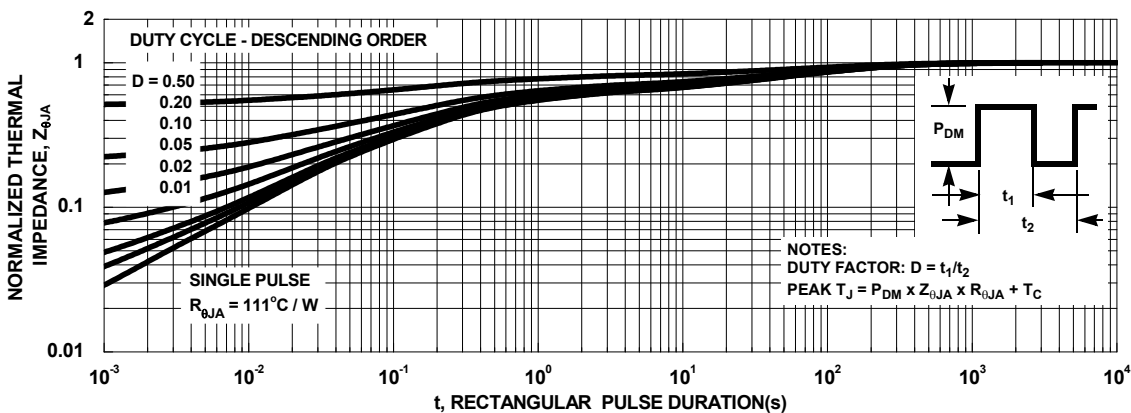

Figure 3. Normalized Maximum Transient Thermal Impedance

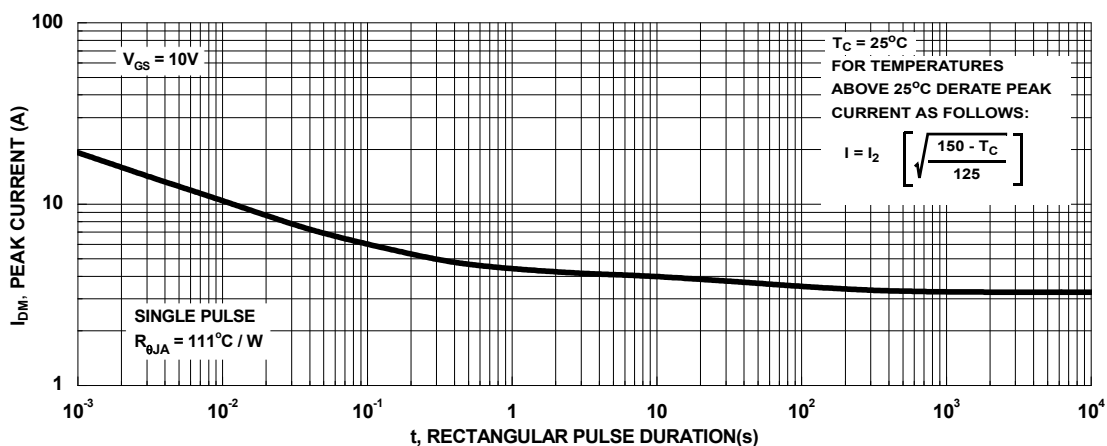

Figure 4. Peak Current Capability

## Typical Characteristics

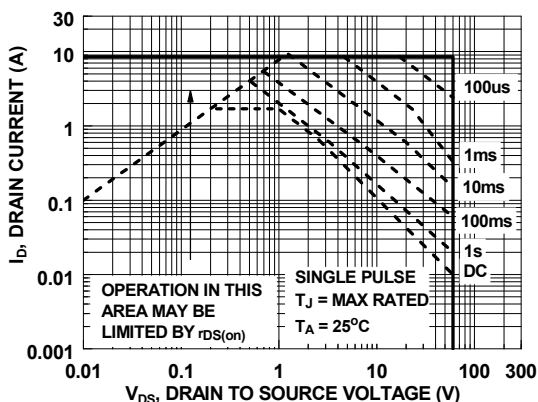

Figure 5. Forward Bias Safe Operating Area

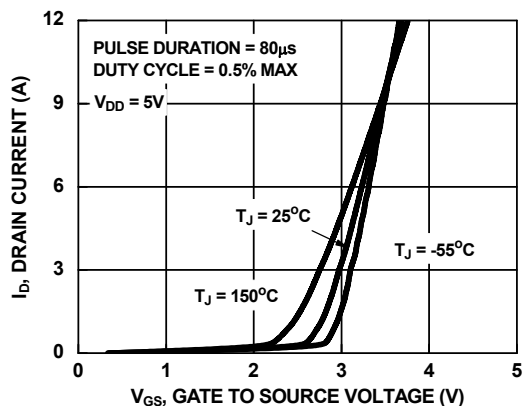

Figure 6. Transfer Characteristics

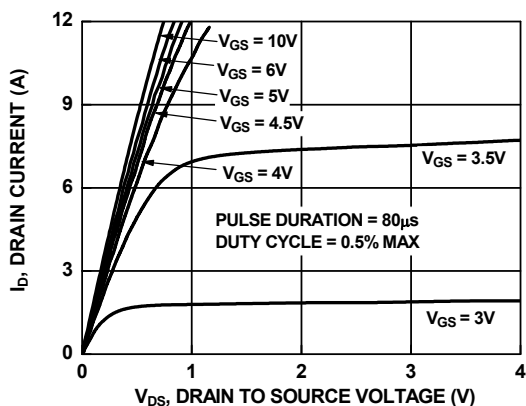

Figure 7. Saturation Characteristics

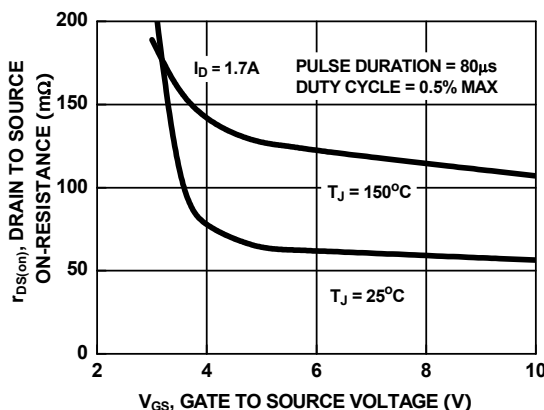

Figure 8. Drain to Source On-Resistance Variation vs Gate to Source Voltage

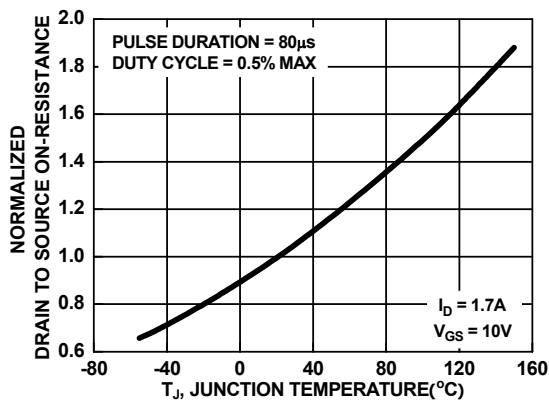

Figure 9. Normalized Drain to Source On Resistance vs Junction Temperature

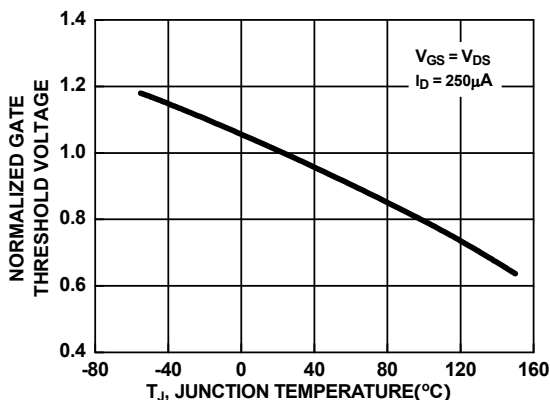

Figure 10. Normalized Gate Threshold Voltage vs Junction Temperature

## Typical Characteristics

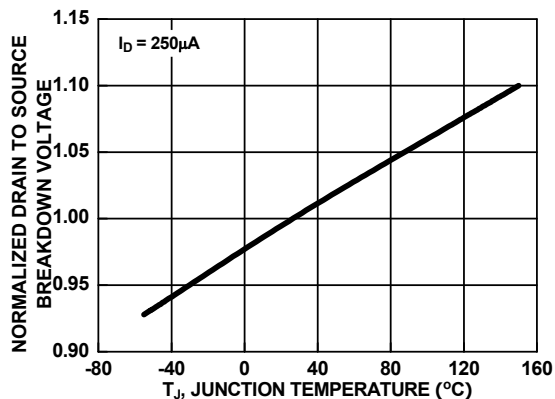

Figure 11. Normalized Drain to Source Breakdown Voltage vs Junction Temperature

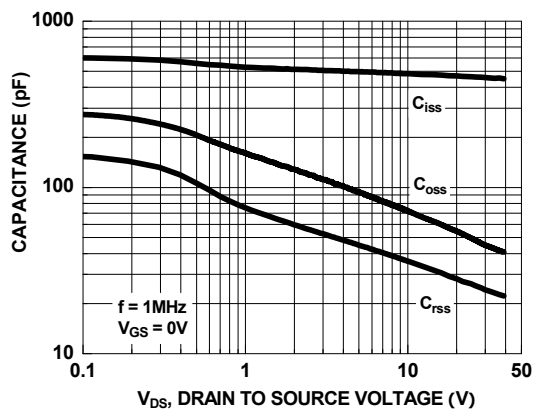

Figure 12. Capacitance vs Drain to Source Voltage

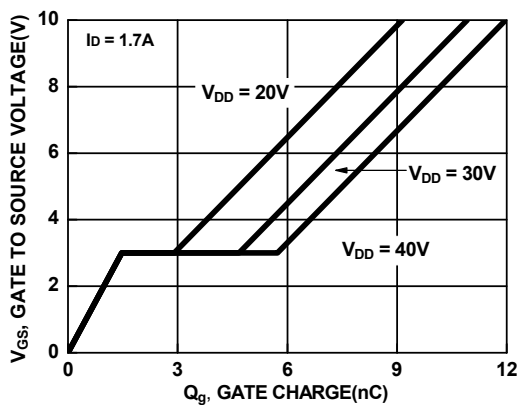
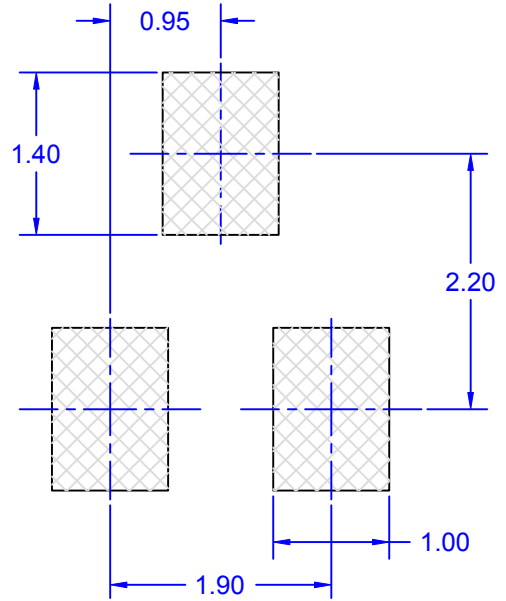
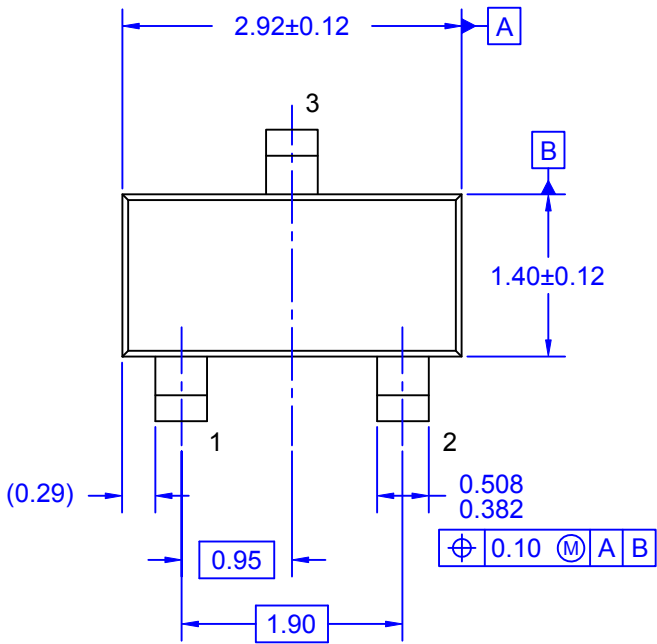
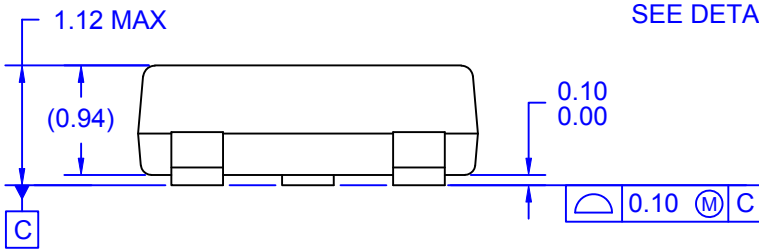

Figure 13. Gate Charge vs Gate to Source Voltage



LAND PATTERN RECOMMENDATION



SEE DETAIL A

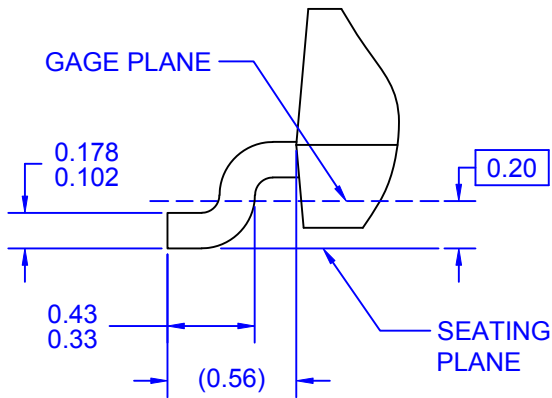
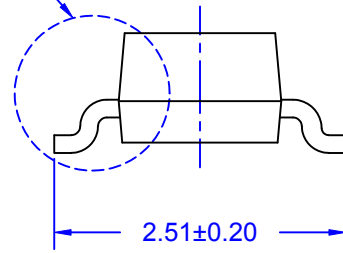

**DETAIL A**

SCALE: 50:1

NOTES: UNLESS OTHERWISE SPECIFIED

- A) NO JEDEC REFERENCE AS OF AUGUST 2003
- B) ALL DIMENSIONS ARE IN MILLIMETERS.
- C) DIMENSIONS ARE EXCLUSIVE OF BURRS, MOLD FLASH AND TIE BAR EXTRUSIONS.
- D) DIMENSIONING AND TOLERANCING PER ASME Y14.5M - 2009.
- E) DRAWING FILE NAME: MKT-MA03BREV3



ON Semiconductor and  are trademarks of Semiconductor Components Industries, LLC dba ON Semiconductor or its subsidiaries in the United States and/or other countries. ON Semiconductor owns the rights to a number of patents, trademarks, copyrights, trade secrets, and other intellectual property. A listing of ON Semiconductor's product/patent coverage may be accessed at [www.onsemi.com/site/pdf/Patent-Marking.pdf](http://www.onsemi.com/site/pdf/Patent-Marking.pdf). ON Semiconductor reserves the right to make changes without further notice to any products herein. ON Semiconductor makes no warranty, representation or guarantee regarding the suitability of its products for any particular purpose, nor does ON Semiconductor assume any liability arising out of the application or use of any product or circuit, and specifically disclaims any and all liability, including without limitation special, consequential or incidental damages. Buyer is responsible for its products and applications using ON Semiconductor products, including compliance with all laws, regulations and safety requirements or standards, regardless of any support or applications information provided by ON Semiconductor. "Typical" parameters which may be provided in ON Semiconductor data sheets and/or specifications can and do vary in different applications and actual performance may vary over time. All operating parameters, including "Typicals" must be validated for each customer application by customer's technical experts. ON Semiconductor does not convey any license under its patent rights nor the rights of others. ON Semiconductor products are not designed, intended, or authorized for use as a critical component in life support systems or any FDA Class 3 medical devices or medical devices with a same or similar classification in a foreign jurisdiction or any devices intended for implantation in the human body. Should Buyer purchase or use ON Semiconductor products for any such unintended or unauthorized application, Buyer shall indemnify and hold ON Semiconductor and its officers, employees, subsidiaries, affiliates, and distributors harmless against all claims, costs, damages, and expenses, and reasonable attorney fees arising out of, directly or indirectly, any claim of personal injury or death associated with such unintended or unauthorized use, even if such claim alleges that ON Semiconductor was negligent regarding the design or manufacture of the part. ON Semiconductor is an Equal Opportunity/Affirmative Action Employer. This literature is subject to all applicable copyright laws and is not for resale in any manner.

## PUBLICATION ORDERING INFORMATION

### LITERATURE FULFILLMENT:

Literature Distribution Center for ON Semiconductor  
19521 E. 32nd Pkwy, Aurora, Colorado 80011 USA  
**Phone:** 303-675-2175 or 800-344-3860 Toll Free USA/Canada  
**Fax:** 303-675-2176 or 800-344-3867 Toll Free USA/Canada  
**Email:** [orderlit@onsemi.com](mailto:orderlit@onsemi.com)

**N. American Technical Support:** 800-282-9855 Toll Free  
USA/Canada  
**Europe, Middle East and Africa Technical Support:**  
Phone: 421 33 790 2910  
**Japan Customer Focus Center**  
Phone: 81-3-5817-1050

**ON Semiconductor Website:** [www.onsemi.com](http://www.onsemi.com)  
**Order Literature:** <http://www.onsemi.com/orderlit>  
For additional information, please contact your local  
Sales Representative



# Mouser Electronics

Authorized Distributor

Click to View Pricing, Inventory, Delivery & Lifecycle Information:

[ON Semiconductor:](#)

[FDN5632N\\_F085](#)



Компания «ЭлектроПласт» предлагает заключение долгосрочных отношений при поставках импортных электронных компонентов на взаимовыгодных условиях!

Наши преимущества:

- Оперативные поставки широкого спектра электронных компонентов отечественного и импортного производства напрямую от производителей и с крупнейших мировых складов;
- Поставка более 17-ти миллионов наименований электронных компонентов;
- Поставка сложных, дефицитных, либо снятых с производства позиций;
- Оперативные сроки поставки под заказ (от 5 рабочих дней);
- Экспресс доставка в любую точку России;
- Техническая поддержка проекта, помощь в подборе аналогов, поставка прототипов;
- Система менеджмента качества сертифицирована по Международному стандарту ISO 9001;
- Лицензия ФСБ на осуществление работ с использованием сведений, составляющих государственную тайну;
- Поставка специализированных компонентов (Xilinx, Altera, Analog Devices, Intersil, Interpoint, Microsemi, Aeroflex, Peregrine, Syfer, Eurofarad, Texas Instrument, Miteq, Cobham, E2V, MA-COM, Hittite, Mini-Circuits, General Dynamics и др.);

Помимо этого, одним из направлений компании «ЭлектроПласт» является направление «Источники питания». Мы предлагаем Вам помощь Конструкторского отдела:

- Подбор оптимального решения, техническое обоснование при выборе компонента;
- Подбор аналогов;
- Консультации по применению компонента;
- Поставка образцов и прототипов;
- Техническая поддержка проекта;
- Защита от снятия компонента с производства.



#### Как с нами связаться

**Телефон:** 8 (812) 309 58 32 (многоканальный)

**Факс:** 8 (812) 320-02-42

**Электронная почта:** [org@eplast1.ru](mailto:org@eplast1.ru)

**Адрес:** 198099, г. Санкт-Петербург, ул. Калинина, дом 2, корпус 4, литера А.