

DELPHI SERIES



FEATURES

- ♦ High efficiency: 90% @5V/7A
- ♦ Industry standard 1x2 pin out
- ♦ Size: 33.0x24.4x8.55mm (1.30"x0.96"x0.34")
- ♦ SMD and Through-hole versions
- ♦ Fixed frequency operation
- ♦ 2:1 input voltage range
- ♦ Input UVLO, OVP
- ♦ OTP and output OCP, OVP (default is auto-restart)
- ♦ Output voltage trim $\pm 10\%$
- ♦ Negative On/Off
- ♦ Monotonic startup into normal and pre-biased loads
- ♦ 2250V isolation and basic insulation
- ♦ No minimum load required
- ♦ ISO 9001, TL 9000, ISO 14001, QS9000, OHSAS18001 certified manufacturing facility
- ♦ UL/cUL 60950 (US & Canada) recognized,

Delphi Series S48SP, 35W 1x1 Brick DC/DC Power Modules: 48V in, 5V/7A out

The Delphi Series S48SP, 1x1 Brick, 48V input, single output, isolated DC/DC converters are the latest offering from a world leader in power systems technology and manufacturing -- Delta Electronics, Inc. This product family is available in a surface mount or through-hole package and provides up to 35 watts of power or 10A of output current (3.3V and below) in a new 1x1 form factor (1.3"x0.96"). The pinout is compatible with the industry standard 1x2 products. With creative design technology and optimization of component placement, these converters possess outstanding electrical and thermal performance, as well as extremely high reliability under highly stressful operating conditions. Typical efficiency of the 5V/7A module is 90%. All modules are fully protected against abnormal input/output voltage, current, and temperature conditions.

OPTIONS

- ♦ Positive On/Off or no On/Off
- ♦ OTP and Output OVP, OCP mode, Auto recovery (default) or latch-up
- ♦ SMD module available
- ♦ Short pin lengths
- ♦ Encapsulated case optional

APPLICATIONS

- ♦ Optical Transport
- ♦ Data Networking
- ♦ Communications, including Wireless and traditional Telecom
- ♦ Servers

DATASHEET

DS_S48SP05007_10252013

TECHNICAL SPECIFICATIONS

(T_A=25°C, airflow rate=300 LFM, V_{in}=48Vdc, nominal V_{out} unless otherwise noted.)

PARAMETER	NOTES and CONDITIONS	S48SP05007 (Standard)			
		Min.	Typ.	Max.	Units
ABSOLUTE MAXIMUM RATINGS					
Input Voltage					
Continuous				80	Vdc
Transient(100ms)	100ms			100	Vdc
Operating Temperature		-40		85	°C
Storage Temperature		-55		+125	°C
Input/Output Isolation Voltage				2250	Vdc
INPUT CHARACTERISTICS					
Operating Input Voltage		36		75	Vdc
Input Under-Voltage Lockout					
Turn-On Voltage Threshold	I _o =100% load	32.8	34	35.2	Vdc
Turn-Off Voltage Threshold	I _o =100% load	30.8	31.8	32.8	Vdc
Lockout Hysteresis Voltage	I _o =100% load		2		Vdc
Maximum Input Current	100% Load, 36V _{in}			1.10	A
No-Load Input Current			35		mA
Off Converter Input Current	V _{in} = 48V		9		mA
Inrush Current (I _{in})				0.01	A ² s
Input Reflected-Ripple Current	P-P thru 12μH inductor, 5Hz to 20MHz		10		mA
Input Voltage Ripple Rejection	120 Hz		60		dB
OUTPUT CHARACTERISTICS					
Output Voltage Set Point	V _{in} =48V, I _o =I _{o,max} , T _c =25°C	4.925	5.0	5.075	Vdc
Output Voltage Regulation					
Over Load	I _o =I _{o, min} to I _{o, max}		±3	±10	mV
Over Line	V _{in} =36V to 75V		±3	±10	mV
Over Temperature	T _c =-40°C to 100°C			±50	mV
Total Output Voltage Range	Over load, line and temperature	4.85		5.15	V
Output Voltage Ripple and Noise					
Peak-to-Peak	5Hz to 20MHz bandwidth				
RMS	Full Load, 1μF ceramic, 10μF tantalum		30		mV
Operating Output Current Range	Full Load, 1μF ceramic, 10μF tantalum		10		mV
Output DC Current-Limit Inception	V _{in} =36V to 75V	0		7	A
	V _{in} =48V, Output Voltage 10% Low	110		140	%
DYNAMIC CHARACTERISTICS					
Output Voltage Current Transient	48V, 10μF Tan & 1μF Ceramic load cap, 0.1A/μs				
Positive Step Change in Output Current	50% I _{o,max} to 75% I _{o,max}		150		mV
Negative Step Change in Output Current	75% I _{o,max} to 50% I _{o,max}		150		mV
Settling Time (within 1% V _{out} nominal)			100		us
Turn-On Transient					
Start-Up Time, From On/Off Control			25	30	ms
Start-Up Time, From Input			25	30	ms
Maximum Output Capacitance	Full load; 5% overshoot of V _{out} at startup			3000	μF
EFFICIENCY					
100% Load			89.5		%
60% Load			88.5		%
ISOLATION CHARACTERISTICS					
+V _{in} & -V _{in} short, +V _o & -V _o short					
Input to Output				2250	Vdc
Isolation Resistance		10			MΩ
Isolation Capacitance			1000		pF
FEATURE CHARACTERISTICS					
Switching Frequency			400		kHz
ON/OFF Control, Negative Remote On/Off logic					
Logic Low (Module On)	V _{on/off}	-0.7		0.8	V
Logic High (Module Off)	V _{on/off}	2		18	V
ON/OFF Control, Positive Remote On/Off logic					
Logic Low (Module Off)	V _{on/off}	-0.7		0.8	V
Logic High (Module On)	V _{on/off}	2		18	V
ON/OFF Current (for both remote on/off logic)	I _{on/off} at V _{on/off} =0.0V		0.25		mA
Leakage Current (for both remote on/off logic)	Logic High, V _{on/off} =15V			30	μA
Output Voltage Trim Range	Across Pins 4 & 5, P _{out} max rated power	-10%		10%	%
Output Over-Voltage Protection	Over full temp range	5.75		7.5	V
GENERAL SPECIFICATIONS					
MTBF	I _o =80% of I _{o, max} ; T _a =25°C; air flow 300LFM		2.82		M hours
Weight			10.5		grams
Over-Temperature Shutdown	Refer to Fig. 20 for measuring point		123		°C

ELECTRICAL CHARACTERISTICS CURVES

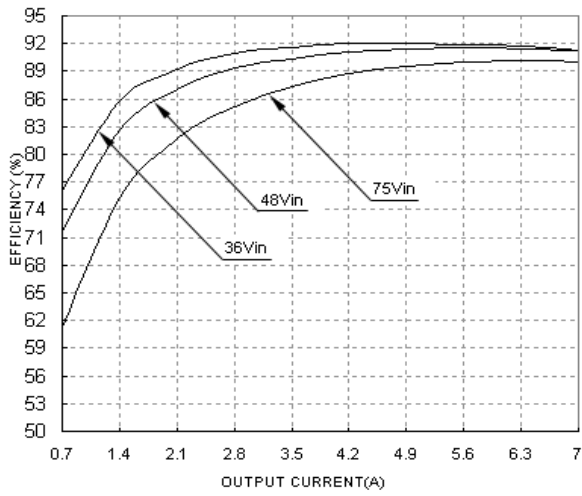

Figure 1: Efficiency vs. load current for minimum, nominal, and maximum input voltage at 25°C

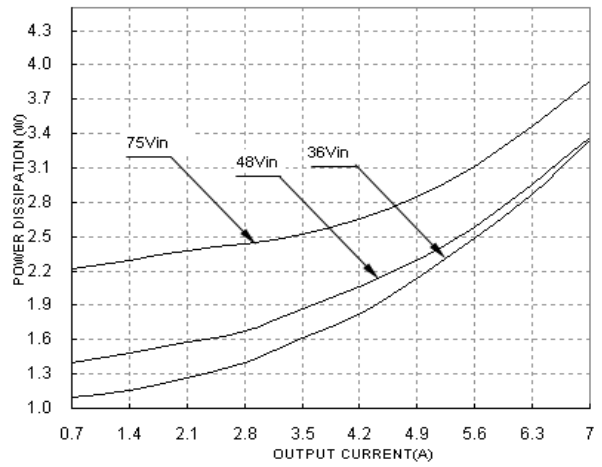

Figure 2: Power dissipation vs. load current for minimum, nominal, and maximum input voltage at 25°C.

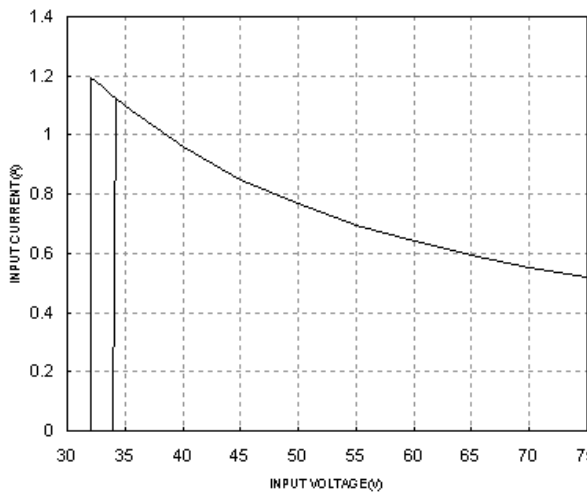

Figure 3: Typical full load input characteristics at room temperature

ELECTRICAL CHARACTERISTICS CURVES

For Negative Remote On/Off Logic

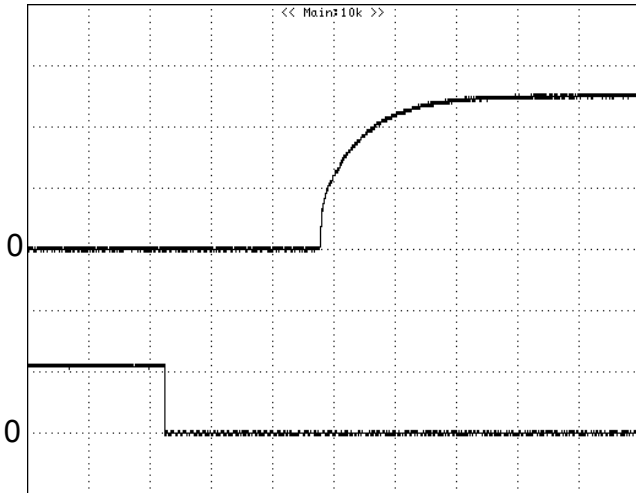

Figure 4: Turn-on transient at full rated load current (5 ms/div). $V_{in}=48V$. Top Trace: V_{out} , 2V/div; Bottom Trace: ON/OFF input, 2V/div

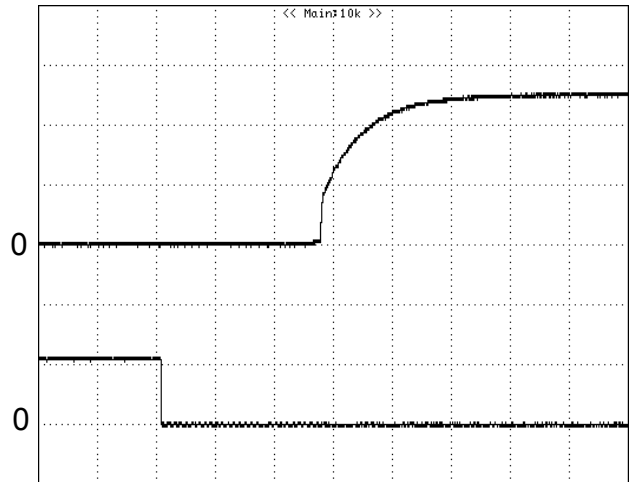

Figure 5: Turn-on transient at zero load current (5 ms/div). $V_{in}=48V$. Top Trace: V_{out} , 2V/div, Bottom Trace: ON/OFF input, 2V/div

For Positive Remote On/Off Logic

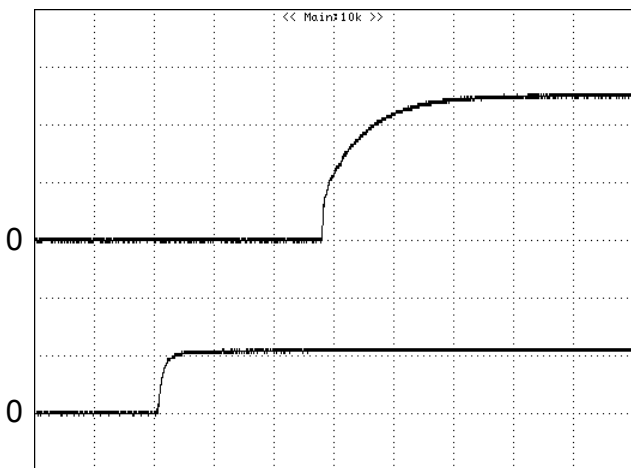

Figure 6: Turn-on transient at full rated load current (5 ms/div). $V_{in}=48V$. Top Trace: V_{out} , 2V/div; Bottom Trace: ON/OFF input, 2V/div

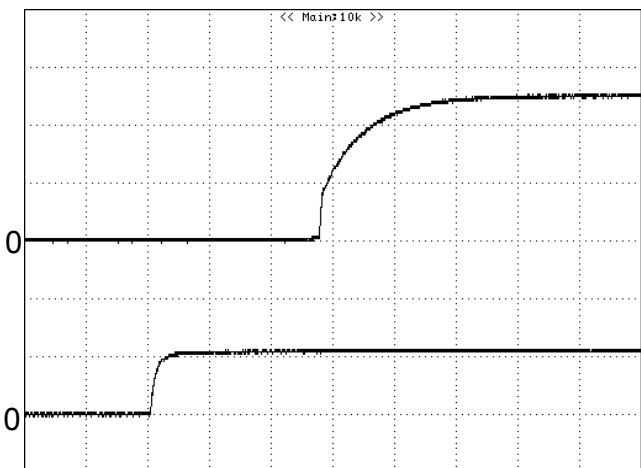

Figure 7: Turn-on transient at zero load current (5 ms/div). $V_{in}=48V$. Top Trace: V_{out} , 2V/div; Bottom Trace: ON/OFF input, 2V/div

ELECTRICAL CHARACTERISTICS CURVES

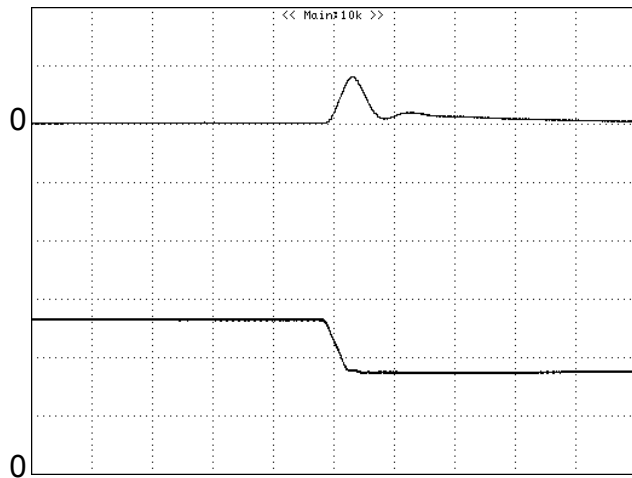

Figure 8: Output voltage response to step-change in load current (75%-50% of $I_{o, \max}$; $di/dt = 0.1A/\mu s$). Load cap: $10\mu F$ tantalum capacitor and $1\mu F$ ceramic capacitor. Top Trace: V_{out} (100mV/div, 50us/div), Bottom Trace: I_{out} (2A/div). Scope measurement should be made using a BNC cable (length shorter than 20 inches). Position the load between 51 mm to 76 mm (2 inches to 3 inches) from the module

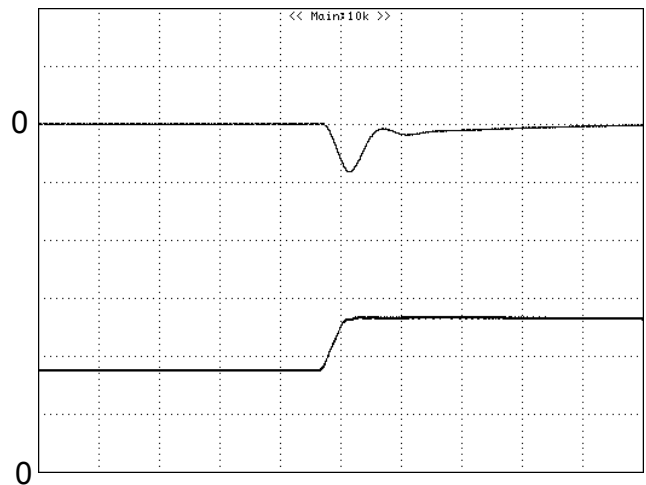

Figure 9: Output voltage response to step-change in load current (50%-75% of $I_{o, \max}$; $di/dt = 0.1A/\mu s$). Load cap: $10\mu F$ tantalum capacitor and $1\mu F$ ceramic capacitor. Top Trace: V_{out} (100mV/div, 50us/div), Bottom Trace: I_{out} (2A/div). Scope measurement should be made using a BNC cable (length shorter than 20 inches). Position the load between 51 mm to 76 mm (2 inches to 3 inches) from the module

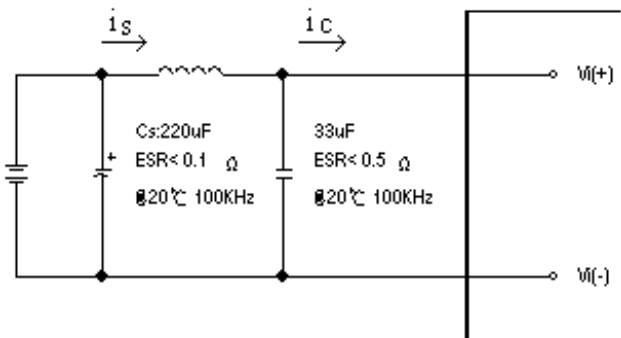

Figure 10: Test set-up diagram showing measurement points for Input Terminal Ripple Current and Input Reflected Ripple Current.

Note: Measured input reflected-ripple current with a simulated source Inductance (L_{TEST}) of $12\mu H$. Capacitor C_s offset possible battery impedance. Measure current as shown below.

ELECTRICAL CHARACTERISTICS CURVES

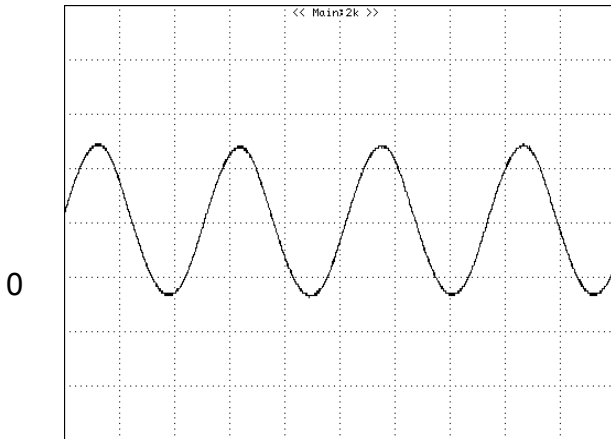

Figure 11: Input Terminal Ripple Current, i_c , at full rated output current and nominal input voltage with $12\mu\text{H}$ source impedance and $33\mu\text{F}$ electrolytic capacitor (100mA/div , $1\mu\text{s/div}$)

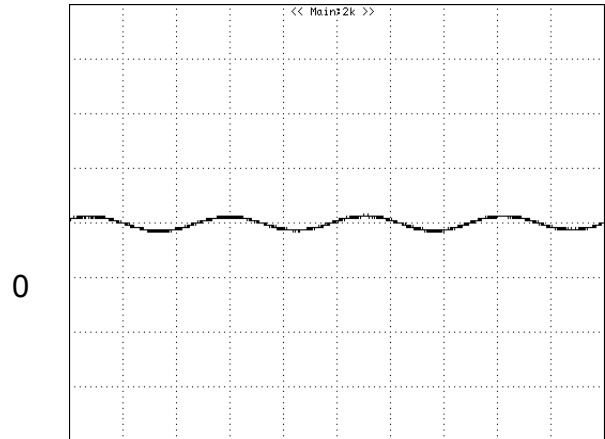

Figure 12: Input reflected ripple current, i_s , through a $12\mu\text{H}$ source inductor at nominal input voltage and rated load current (20 mA/div , $1\mu\text{s/div}$)

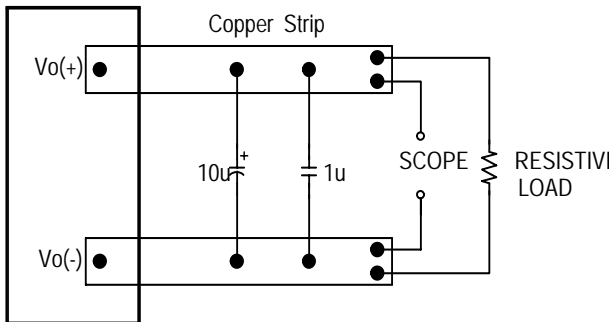

Figure 13: Output voltage noise and ripple measurement test setup

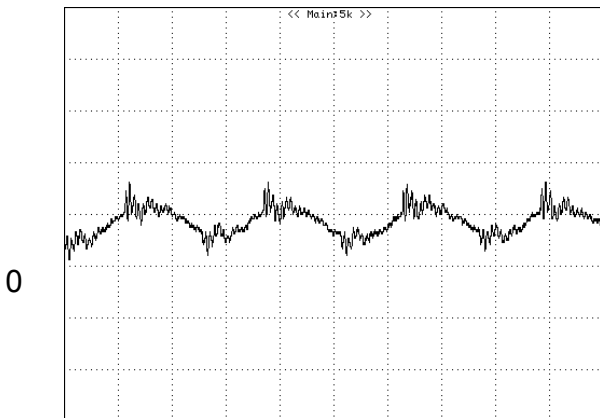

Figure 14: Output voltage ripple at nominal input voltage and rated load current ($I_o=7\text{A}$) (20 mV/div , $1\mu\text{s/div}$)
Load capacitance: $1\mu\text{F}$ ceramic capacitor and $10\mu\text{F}$ tantalum capacitor. Bandwidth: 20 MHz . Scope measurements should be made using a BNC cable (length shorter than 20 inches). Position the load between 51 mm to 76 mm (2 inches to 3 inches) from the module

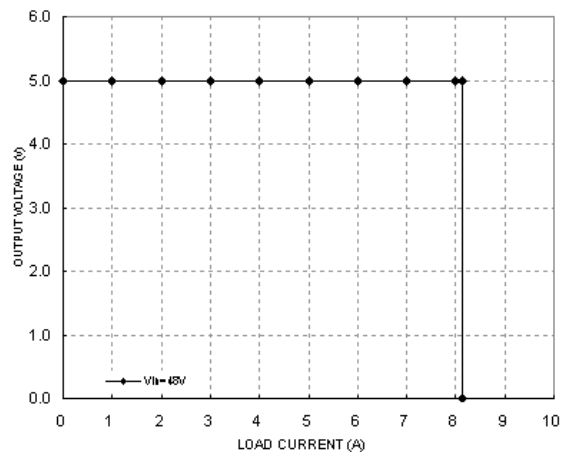

Figure 15: Output voltage vs. load current showing typical current limit curves and converter shutdown points

DESIGN CONSIDERATIONS

Input Source Impedance

The impedance of the input source connecting to the DC/DC power modules will interact with the modules and affect the stability. A low ac-impedance input source is recommended. If the source inductance is more than a few μH , we advise adding a 10 to 100 μF electrolytic capacitor ($\text{ESR} < 0.7 \Omega$ at 100 kHz) mounted close to the input of the module to improve the stability.

Layout and EMC Considerations

Delta's DC/DC power modules are designed to operate in a wide variety of systems and applications. For design assistance with EMC compliance and related PWB layout issues, please contact Delta's technical support team. An external input filter module is available for easier EMC compliance design. Application notes to assist designers in addressing these issues are pending to release.

Safety Considerations

The power module must be installed in compliance with the spacing and separation requirements of the end-user's safety agency standard, i.e., UL60950-1, CSA C22.2 NO. 60950-1 2nd and IEC 60950-1 2nd : 2005 and EN 60950-1 2nd: 2006+A11+A1: 2010, if the system in which the power module is to be used must meet safety agency requirements.

Basic insulation based on 75 Vdc input is provided between the input and output of the module for the purpose of applying insulation requirements when the input to this DC-to-DC converter is identified as TNV-2 or SELV. An additional evaluation is needed if the source is other than TNV-2 or SELV.

When the input source is SELV circuit, the power module meets SELV (safety extra-low voltage) requirements. If the input source is a hazardous voltage which is greater than 60 Vdc and less than or equal to 75 Vdc, for the module's output to meet SELV requirements, all of the following must be met:

- The input source must be insulated from the ac mains by reinforced or double insulation.
- The input terminals of the module are not operator accessible.
- A SELV reliability test is conducted on the system where the module is used, in combination with the module, to ensure that under a single fault, hazardous voltage does not appear at the module's output.

When installed into a Class II equipment (without grounding), spacing consideration should be given to the end-use installation, as the spacing between the module and mounting surface have not been evaluated.

The power module has extra-low voltage (ELV) outputs when all inputs are ELV.

This power module is not internally fused. To achieve optimum safety and system protection, an input line fuse is highly recommended. The safety agencies require a fuse with 3A maximum rating to be installed in the ungrounded lead. A lower rated fuse can be used based on the maximum inrush transient energy and maximum input current.

Soldering and Cleaning Considerations

Post solder cleaning is usually the final board assembly process before the board or system undergoes electrical testing. Inadequate cleaning and/or drying may lower the reliability of a power module and severely affect the finished circuit board assembly test. Adequate cleaning and/or drying is especially important for un-encapsulated and/or open frame type power modules. For assistance on appropriate soldering and cleaning procedures, please contact Delta's technical support team.

FEATURES DESCRIPTIONS

Over-Current Protection

The modules include an internal output over-current protection circuit, which will endure current limiting for an unlimited duration during output overload. If the output current exceeds the OCP set point, the modules will automatically shut down, and enter hiccup mode or latch mode, which is optional.

For hiccup mode, the module will try to restart after shutdown. If the overload condition still exists, the module will shut down again. This restart trial will continue until the overload condition is corrected.

For latch mode, the module will latch off once it shutdown. The latch is reset by either cycling the input power or by toggling the on/off signal for one second.

Over-Voltage Protection

The modules include an internal output over-voltage protection circuit, which monitors the voltage on the output terminals. If this voltage exceeds the over-voltage set point, the module will shut down, and enter in hiccup mode or latch mode, which is optional.

For hiccup mode, the module will try to restart after shutdown. If the overload condition still exists, the module will shut down again. This restart trial will continue until the overload condition is corrected.

For latch mode, the module will latch off once it shutdown. The latch is reset by either cycling the input power or by toggling the on/off signal for one second.

Over-Temperature Protection

The over-temperature protection consists of circuitry that provides protection from thermal damage. If the temperature exceeds the over-temperature threshold the module will shut down, and enter in hiccup mode or latch mode, which is optional.

For hiccup mode, the module will try to restart after shutdown. If the overload condition still exists, the module will shut down again. This restart trial will continue until the overload condition is corrected.

For latch mode, the module will latch off once it shutdown. The latch is reset by either cycling the input power or by toggling the on/off signal for one second.

Remote On/Off

The remote on/off feature on the module can be either negative or positive logic. Negative logic turns the module on during a logic low and off during a logic high. Positive logic turns the modules on during a logic high and off during a logic low.

Remote on/off can be controlled by an external switch between the on/off terminal and the Vi(-) terminal. The switch can be an open collector or open drain.

For negative logic if the remote on/off feature is not used, please short the on/off pin to Vi(-). For positive logic if the remote on/off feature is not used, please leave the on/off pin floating.

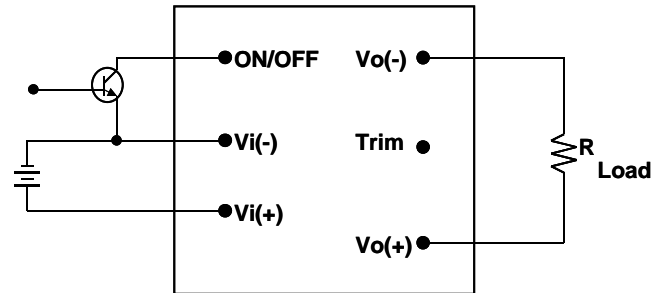

Figure 16: Remote on/off implementation

FEATURES DESCRIPTIONS (CON.)

Output Voltage Adjustment

To increase or decrease the output voltage set point, the modules may be connected with an external resistor between the TRIM pin and either the Vo(+) or Vo(-). The TRIM pin should be left open if this feature is not used.

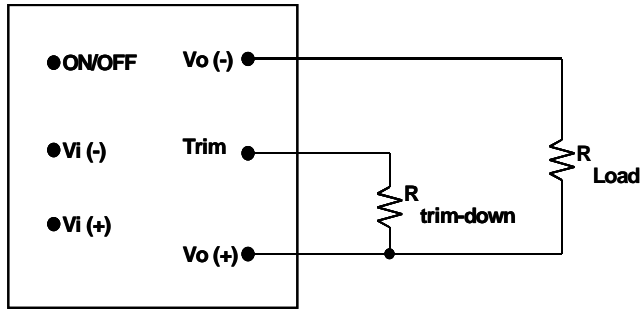

Figure 17: Circuit configuration for trim-down (decrease output voltage)

If the external resistor is connected between the TRIM and Vo(+) pins, the output voltage set point decreases (Fig. 17). The external resistor value required to obtain an output voltage change from 5V to the desired Vo_adj is defined as:

$$R_{\text{trim_down}} = \frac{(V_{o_adj} - 2.5) \cdot 5110}{5.0 - V_{o_adj}} - 2050$$

Ex. When Trim-down -10%

$$V_{o_adj} = 5.0V \times (1 - 10\%) = 4.5V$$

$$R_{\text{trim_down}} = \frac{(4.5 - 2.5) \cdot 5110}{5.0 - 4.5} - 2050$$

$$R_{\text{trim_down}} = 1.839 \times 10^4 \text{ ohm}$$

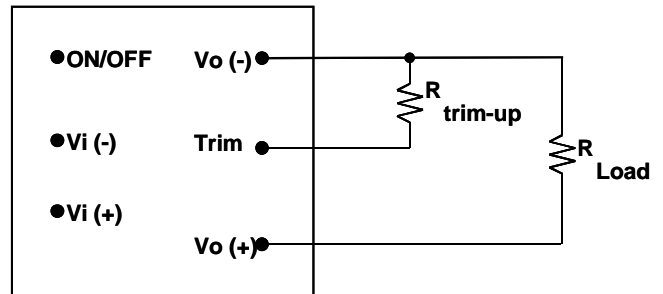

Figure 18: Circuit configuration for trim-up (increase output voltage)

If the external resistor is connected between the TRIM and Vo(-) the output voltage set point increases (Fig. 18). The external resistor value required to obtain an output voltage change from 5V to the desired Vo_adj is defined as:

$$R_{\text{trim_up}} = \frac{2.5 \cdot 5110}{V_{o_adj} - 5.0} - 2050$$

Ex. When Trim-up +10%

$$V_{o_adj} = 5.0V \times (1 + 10\%) = 5.5V$$

$$R_{\text{trim_up}} = \frac{2.5 \cdot 5110}{5.5 - 5.0} - 2050$$

$$R_{\text{trim_up}} = 2.35 \times 10^4 \text{ ohm}$$

When using trim function, the output voltage of the module is usually increased, which increases the power output of the module with the same output current.

Care should be taken to ensure that the maximum output power of the module remains at or below the maximum rated power.

THERMAL CONSIDERATIONS

Thermal management is an important part of the system design. To ensure proper, reliable operation, sufficient cooling of the power module is needed over the entire temperature range of the module. Convection cooling is usually the dominant mode of heat transfer.

Hence, the choice of equipment to characterize the thermal performance of the power module is a wind tunnel.

Thermal Testing Setup

Delta's DC/DC power modules are characterized in heated vertical wind tunnels that simulate the thermal environments encountered in most electronics equipment. This type of equipment commonly uses vertically mounted circuit cards in cabinet racks in which the power modules are mounted.

The following figure shows the wind tunnel characterization setup. The power module is mounted on a test PWB and is vertically positioned within the wind tunnel. The space between the neighboring PWB and the top of the power module is constantly kept at 6.35mm (0.25").

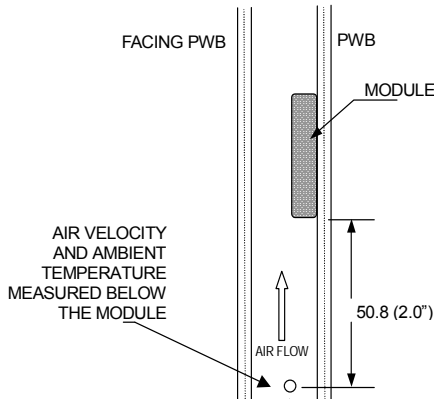

Note: Wind Tunnel Test Setup Figure Dimensions are in millimeters and (Inches)

Figure 19: Wind tunnel test setup

Thermal Derating

Heat can be removed by increasing airflow over the module. To enhance system reliability, the power module should always be operated below the maximum operating temperature. If the temperature exceeds the maximum module temperature, reliability of the unit may be affected.

THERMAL CURVES

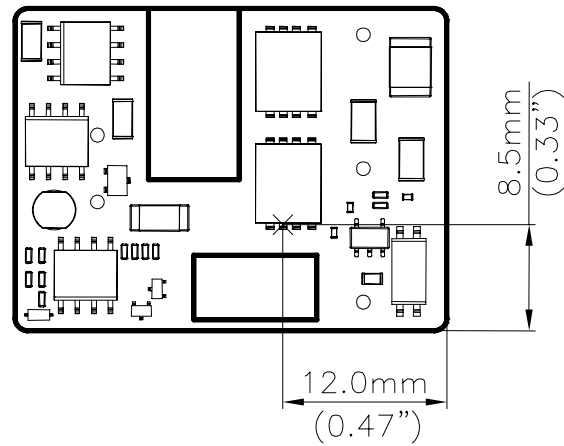

Figure 20: Hot spot temperature measured point
*The allowed maximum hot spot temperature is defined at 111

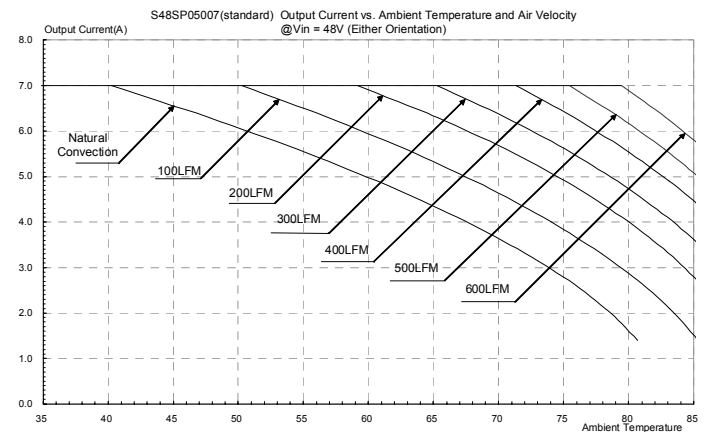
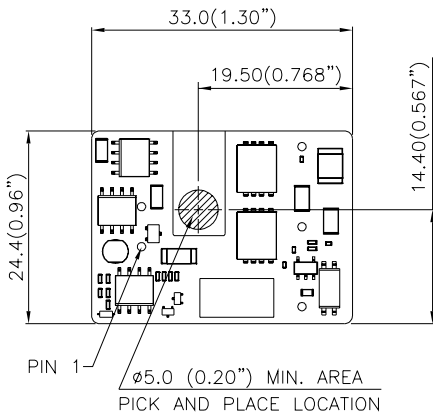

Figure 21: Output current vs. ambient temperature and air velocity @ $V_{in}=48V$ (Either Orientation)

PICK AND PLACE LOCATION



NOTES:
 DIMENSIONS ARE IN MILLIMETERS AND (INCHES)
 TOLERANCES: X.Xmm±0.5mm(X.XX in.±0.02 in.)
 X.XXmm±0.25mm(X.XXX in.±0.010 in.)

SURFACE-MOUNT TAPE & REEL

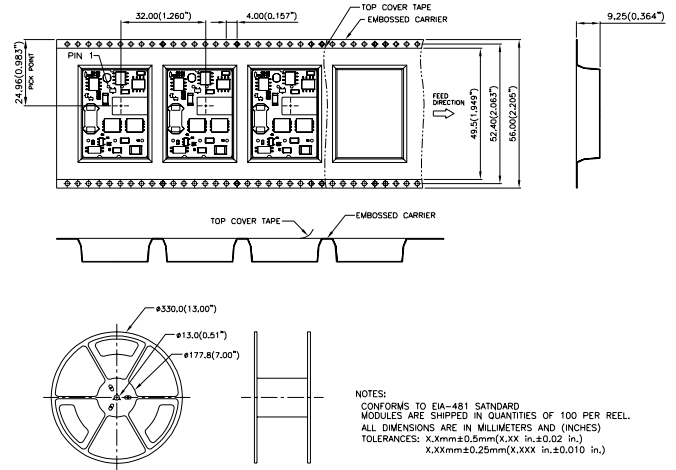

NOTES:
 CONFORMS TO EIA-481 STANDARD
 MODULES ARE SHIPPED IN QUANTITIES OF 100 PER REEL.
 ALL DIMENSIONS ARE IN MILLIMETERS AND (INCHES)
 TOLERANCES: X.Xmm±0.5mm(X.XX in.±0.02 in.)
 X.XXmm±0.25mm(X.XXX in.±0.010 in.)

RECOMMENDED PAD LAYOUT (SMD)

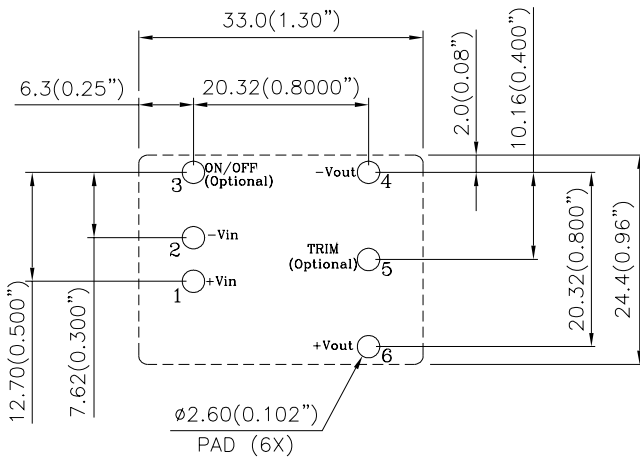

RECOMENDED P.W.B PAD LAYOUT

NOTES:
 DIMENSIONS ARE IN MILLIMETERS AND (INCHES)
 TOLERANCES: X.Xmm±0.5mm(X.XX in.±0.02 in.)
 X.XXmm±0.25mm(X.XXX in.±0.010 in.)

LEADED (Sn/Pb) PROCESS RECOMMEND TEMP. PROFILE

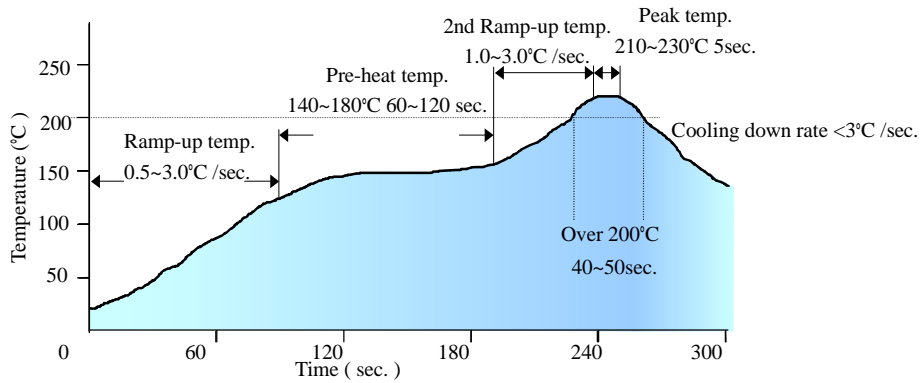

Note: The temperature refers to the pin of S48SP, measured on the pin +Vout joint.

LEAD FREE (SAC) PROCESS RECOMMEND TEMP. PROFILE

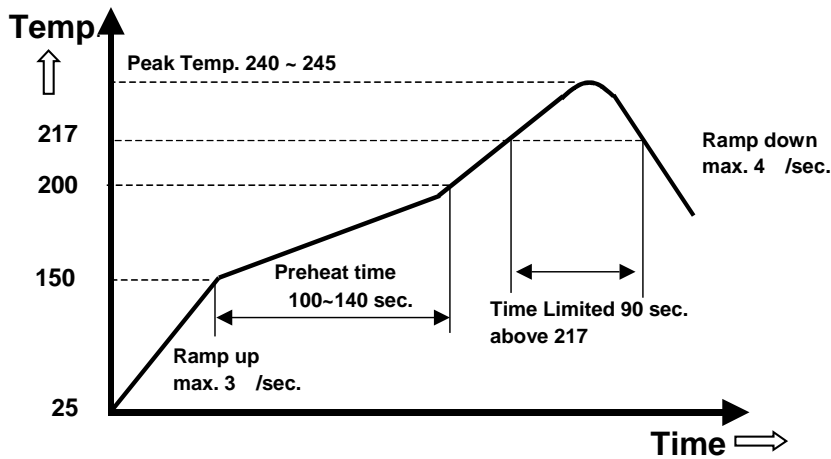

Note: The temperature refers to the pin of S48SP, measured on the pin +Vout joint.

MECHANICAL DRAWING

Surface-mount module

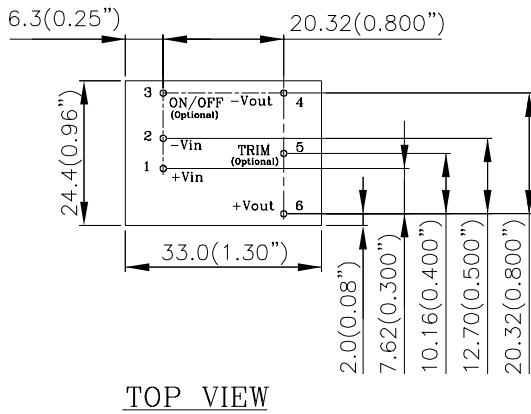

Through-Hole module

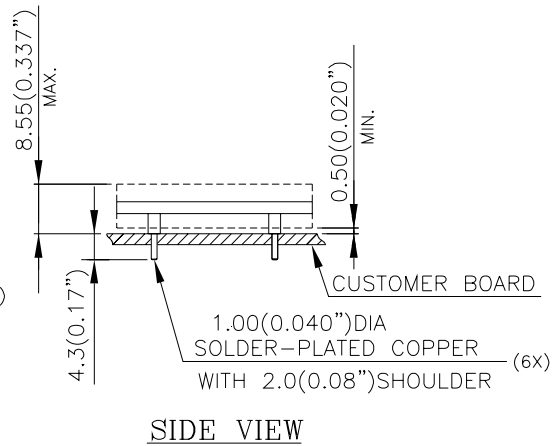
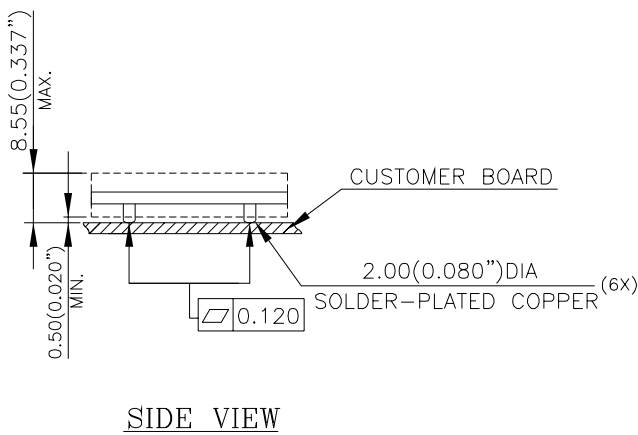
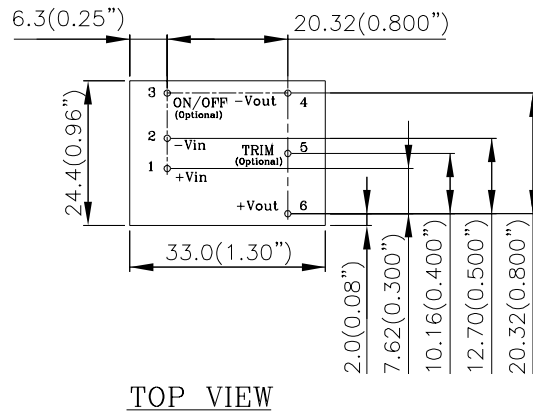

NOTES:
 DIMENSIONS ARE IN MILLIMETERS AND (INCHES)
 TOLERANCES: X.Xmm±0.5mm(X.XX in.±0.02 in.)
 X.XXmm±0.25mm(X.XXX in.±0.010 in.)

Pin No.	Name	Function
1	+Vin	Positive input voltage
2	-Vin	Negative input voltage
3	ON/OFF (Optional)	Remote ON/OFF (Optional)
4	-Vout	Negative output voltage
5	TRIM (Optional)	Output voltage trim (Optional)
6	+Vout	Positive output voltage

Pin Specification:

Pins 1~6 1.00mm (0.040") diameter
 All pins are copper with Tin plating over Nickel under plating.

PART NUMBERING SYSTEM

S	48	S	P	050	07	N	R	F	B
Product Type	Input Voltage	Number of Outputs	Product Series	Output Voltage	Output Current	ON/OFF Logic	Pin Length/Type		Option Code
S - Small Power	48 - 36V~75V	S - Single	1x1, 10A	050 - 5V	07 - 7A	N - Negative (Default) P - Positive E - No remote on/off control pin	R - 0.170" (Default) N - 0.145" K - 0.110" M - SMD	F- RoHS 6/6 (Lead Free)	A - No trim pin B - With trim pin (Default)

MODEL LIST

MODEL NAME	INPUT		OUTPUT		EFF @ 100% LOAD
S48SP3R310NRFB	36V~75V	1.1A	3.3V	10A	89.0%
S48SP05007NRFB	36V~75V	1.2A	5.0V	7A	90.0%
S48SP12003NRFB	36V~75V	1.2A	12V	3A	90.0%
S48SP15002NRFB	36V~75V	1A	15V	2A	90.0%

Note:

1. Default OTP and output OVP, OCP mode is auto-restart;
2. For different option, please refer to part numbering system above or contact Delta local sales.

CONTACT: www.deltaww.com/dcdc

USA:

Telephone:
East Coast: 978-656-3993
West Coast: 510-668-5100
Fax: (978) 656 3964
Email: DCDC@delta-corp.com

Europe:

Telephone: +31-20-655-0967
Fax: +31-20-655-0999
Email: DCDC@delta-es.com

Asia & the rest of world:

Telephone: +886 3 4526107 x6220~6224
Fax: +886 3 4513485
Email: DCDC@delta.com.tw

WARRANTY

Delta offers a two (2) year limited warranty. Complete warranty information is listed on our web site or is available upon request from Delta.

Information furnished by Delta is believed to be accurate and reliable. However, no responsibility is assumed by Delta for its use, nor for any infringements of patents or other rights of third parties, which may result from its use. No license is granted by implication or otherwise under any patent or patent rights of Delta. Delta reserves the right to revise these specifications at any time, without notice.



Компания «ЭлектроПласт» предлагает заключение долгосрочных отношений при поставках импортных электронных компонентов на взаимовыгодных условиях!

Наши преимущества:

- Оперативные поставки широкого спектра электронных компонентов отечественного и импортного производства напрямую от производителей и с крупнейших мировых складов;
- Поставка более 17-ти миллионов наименований электронных компонентов;
- Поставка сложных, дефицитных, либо снятых с производства позиций;
- Оперативные сроки поставки под заказ (от 5 рабочих дней);
- Экспресс доставка в любую точку России;
- Техническая поддержка проекта, помощь в подборе аналогов, поставка прототипов;
- Система менеджмента качества сертифицирована по Международному стандарту ISO 9001;
- Лицензия ФСБ на осуществление работ с использованием сведений, составляющих государственную тайну;
- Поставка специализированных компонентов (Xilinx, Altera, Analog Devices, Intersil, Interpoint, Microsemi, Aeroflex, Peregrine, Syfer, Eurofarad, Texas Instrument, Miteq, Cobham, E2V, MA-COM, Hittite, Mini-Circuits, General Dynamics и др.);

Помимо этого, одним из направлений компании «ЭлектроПласт» является направление «Источники питания». Мы предлагаем Вам помощь Конструкторского отдела:

- Подбор оптимального решения, техническое обоснование при выборе компонента;
- Подбор аналогов;
- Консультации по применению компонента;
- Поставка образцов и прототипов;
- Техническая поддержка проекта;
- Защита от снятия компонента с производства.



Как с нами связаться

Телефон: 8 (812) 309 58 32 (многоканальный)

Факс: 8 (812) 320-02-42

Электронная почта: org@eplast1.ru

Адрес: 198099, г. Санкт-Петербург, ул. Калинина, дом 2, корпус 4, литера А.