

7000 SERIES/HIGH RELIABILITY REED RELAYS

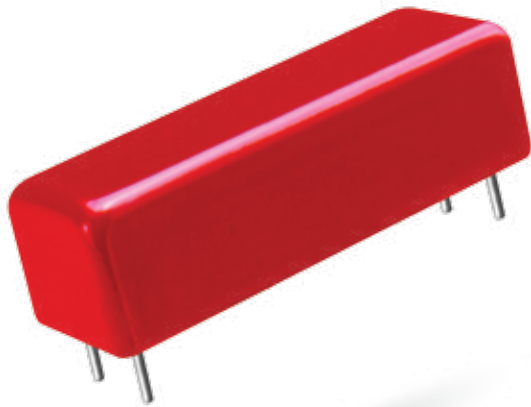

7000 Series High Reliability Reed Relays

The 7000 Series is ideally suited to the needs of Instrumentation, Data Acquisition, Process Control, Telecommunications and General Purpose requirements. The specification tables allow you to select the appropriate relay for your particular application. These models are specifically designed for high quality and reliability with versatile switching capabilities and contact forms. If your requirements differ, please consult your local representative or Coto's Factory to discuss a custom reed relay.

7000 Series Features

- ▶ Multi-pole contact forms (Form A, B, and C)
- ▶ Wide range of switching capabilities; Low level, High Voltage, Hg wetted
- ▶ Hermetically sealed contacts for long life and high reliability
- ▶ High speed switching compared to electromechanical relays
- ▶ Potted in metal shell - Magnetic Shield
- ▶ Optional Electrostatic Shield for reducing capacitive coupling
- ▶ PCB mounting versatility - 1.0" x 0.100" grid
- ▶ Optional coil suppression diode offered to protect coil drivers
- ▶ Custom configurations available - consult factory
- ▶ RoHS compliant (N/A 7201, 7202, 7203, 7204)

DIMENSIONS

in Inches (Millimeters)

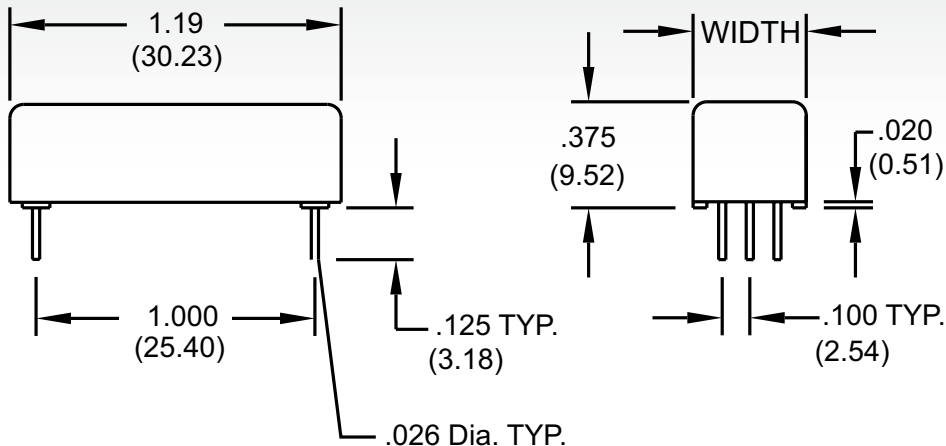

WIDTH	A	B	C	D
Dimension	.410 (10.41)	.500 (12.70)	.660 (16.76)	.760 (19.30)

Table #1

Ordering Information

Part Number	XXXX-XX-1XXX
Model Number	See Tables (7000 Series)
Coil Voltage	
05=5 volts	Coil Termination
12=12 volts	
24=24 volts	
	0=End to End
	1=Same End
	Diode Options
	0=No Diode
	1=Diode Included
	Electrostatic Shield Options
	0=No Electrostatic Shield
	1=Electrostatic Shield

07082013

7000 SERIES

Parameters	Test Conditions	Units	Form A, B ²	Form C	Form A ³ Hg Wetted	Form A High Voltage
CONTACT RATINGS						
Switching Voltage	Max DC/Peak AC Resist.	Volts	200	150	500	500
Switching Current	Max DC/Peak AC Resist.	Amps	0.5	0.25	1.0	0.5
Carry Current	Max DC/Peak AC Resist.	Amps	2.0	0.5	2.0	2.0
Contact Rating	Max DC/Peak AC Resist.	Watts	10	3	50	10
Life Expectancy-Typical ¹	Signal Level 1.0V, 10mA	x 10 ⁶ Ops.	1000	100	1000	100
Static Contact Resistance (max. init.)	50mV, 10mA	Ω	0.100	0.150	0.075	0.100
Dynamic Contact Resistance (max. init.)	0.5V, 50mA at 100 Hz, 1.5 msec	Ω	0.150	0.200	0.100	0.150
RELAY SPECIFICATIONS						
Insulation Resistance (minimum)	Between all Isolated Pins at 100V, 25°C, 40% RH	Ω	10 ¹²	10 ¹⁰	10 ¹²	10 ¹²
Capacitance - Typical Across Open Contacts	No Shield	pF	1.0	2.0	1.0	1.0
	Shield Guarding	pF	0.2	1.0	0.2	0.2
Dielectric Strength (minimum)	Between Contacts	VDC/peak AC	250	200	1000	1200
	Contacts to Shield	VDC/peak AC	1000	1000	1000	1000
	Contacts/Shield to Coil	VDC/peak AC	1500	1500	1500	1500
Operate Time - including bounce - Typical	At Nominal Coil Voltage, 30 Hz Square Wave	msec.	1.0	2.0	2.0	1.0
Release Time - Typical		msec.	0.1	2.5	1.0	0.1

Dot stamped on top of relay refers to pin #1 location

(See following pages for schematic diagrams and coil data.)

Notes:

¹ Consult factory for life expectancy at other switching loads.

² Optional coil suppression diode Pin #1 is +.

³ Hg Content: Form A, 0.04 grams per capsule; Form C, 0.072 grams per capsule.

Environmental Ratings:

Storage Temp: -35°C to +100°C; *Operating Temp:* -20°C to +85°C; *Solder Temp:* 270°C max; 10 sec. max

All electrical parameters measured at 25°C unless otherwise specified.

Vibration: 20 G's to 2000 Hz; *Shock:* 50 G's

07082013

7000 SERIES/HIGH RELIABILITY REED RELAYS

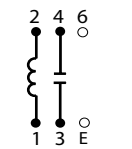
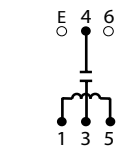
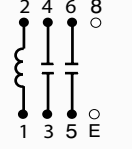
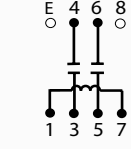
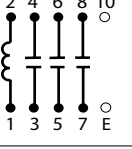
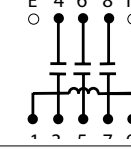
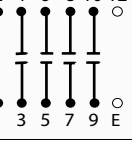
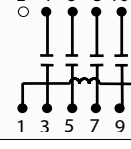
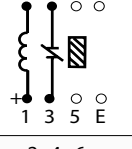
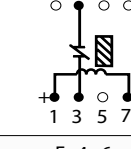
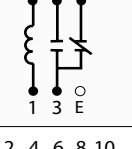
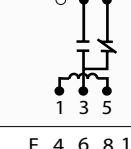
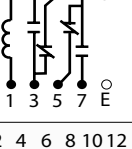
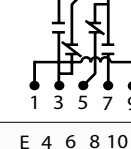
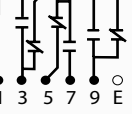
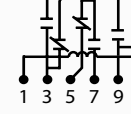
Contact Form	Model Number	Nominal Coil Voltage VDC	Must Operate Voltage VDC max.	Must Release Voltage VDC min.	Coil Resistance $\pm 10\%$ @25°C	Width (See Table #1)	Schematic Top View ^{2,5} End to End Coil	Same End Coil
1A	7101	5 12 24	3.75 9.0 18.0	0.4 1.0 2.0	300 1600 4200	A		
2A	7102	5 12 24	3.75 9.0 18.0	0.4 1.0 2.0	150 1000 3500	B		
3A	7103	5 12 24	3.75 9.0 18.0	0.4 1.0 2.0	100 800 2400	C		
4A	7104	5 12 24	3.75 9.0 18.0	0.4 1.0 2.0	80 550 2000	D		
1B ⁴	7121	5 12 24	3.75 9.0 18.0	0.4 1.0 2.0	150 1000 3500	B		
1C	7141	5 12 24	3.75 9.0 18.0	0.4 1.0 2.0	175 1100 4200	A		
2C	7142	5 12 24	3.75 9.0 18.0	0.4 1.0 2.0	65 490 1550	C		
3C	7143	5 12 24	3.75 9.0 18.0	0.4 1.0 2.0	55 300 1350	D		

Contact Form	Model Number	Nominal Coil Voltage VDC	Must Operate Voltage VDC max.	Must Release Voltage VDC min.	Coil Resistance $\pm 10\%$ @25°C	Width (See Table #1)	Schematic Top View ^{2,5} End to End Coil	Same End Coil
1A Hg wetted ⁵	7201	5 12 24	3.75 9.0 18.0	0.4 1.0 2.0	70 450 1785	A		
2A Hg wetted ⁵	7202	5 12 24	3.75 9.0 18.0	0.4 1.0 2.0	60 340 1330	B		
3A Hg wetted ⁵	7203	5 12 24	3.75 9.0 18.0	0.4 1.0 2.0	50 300 1200	C		
4A Hg wetted ⁵	7204	5 12 24	3.75 9.0 18.0	0.4 1.0 2.0	40 250 960	D		
1A High Voltage	7301	5 12 24	3.75 9.0 18.0	0.4 1.0 2.0	175 1100 4200	A		
2A High Voltage	7302	5 12 24	3.75 9.0 18.0	0.4 1.0 2.0	100 640 2450	B		
3A High Voltage	7303	5 12 24	3.75 9.0 18.0	0.4 1.0 2.0	65 490 1550	C		
4A High Voltage	7304	5 12 24	3.75 9.0 18.0	0.4 1.0 2.0	55 300 1350	D		

Notes:

⁴These relays contain bias magnets. Correct coil polarity must be observed.

⁵ Dot stamped on top of relay refers to pin #1 location. E-pin indicates Electrostatic shield pin. Unused pins omitted. Pin numbers for reference only.

⁶ All models with Hg wetted contacts are position sensitive, must be mounted within 30° of vertical plane. See schematic.



Компания «ЭлектроПласт» предлагает заключение долгосрочных отношений при поставках импортных электронных компонентов на взаимовыгодных условиях!

Наши преимущества:

- Оперативные поставки широкого спектра электронных компонентов отечественного и импортного производства напрямую от производителей и с крупнейших мировых складов;
- Поставка более 17-ти миллионов наименований электронных компонентов;
- Поставка сложных, дефицитных, либо снятых с производства позиций;
- Оперативные сроки поставки под заказ (от 5 рабочих дней);
- Экспресс доставка в любую точку России;
- Техническая поддержка проекта, помощь в подборе аналогов, поставка прототипов;
- Система менеджмента качества сертифицирована по Международному стандарту ISO 9001;
- Лицензия ФСБ на осуществление работ с использованием сведений, составляющих государственную тайну;
- Поставка специализированных компонентов (Xilinx, Altera, Analog Devices, Intersil, Interpoint, Microsemi, Aeroflex, Peregrine, Syfer, Eurofarad, Texas Instrument, Miteq, Cobham, E2V, MA-COM, Hittite, Mini-Circuits, General Dynamics и др.);

Помимо этого, одним из направлений компании «ЭлектроПласт» является направление «Источники питания». Мы предлагаем Вам помощь Конструкторского отдела:

- Подбор оптимального решения, техническое обоснование при выборе компонента;
- Подбор аналогов;
- Консультации по применению компонента;
- Поставка образцов и прототипов;
- Техническая поддержка проекта;
- Защита от снятия компонента с производства.



Как с нами связаться

Телефон: 8 (812) 309 58 32 (многоканальный)

Факс: 8 (812) 320-02-42

Электронная почта: org@eplast1.ru

Адрес: 198099, г. Санкт-Петербург, ул. Калинина, дом 2, корпус 4, литера А.