

SPEC

Spec No.	TQ3C-8EAF0-E1YAC18-00
Date	June 24, 2011

TYPE : TCG121SVLPBANN-AN00

< 12.1 inch SVGA transmissive color TFT
with LED backlight >

CONTENTS

1. Application
2. Construction and outline
3. Mechanical specifications
4. Absolute maximum ratings
5. Electrical characteristics
6. Optical characteristics
7. Interface signals
8. Input timing characteristics
9. Backlight system
10. Lot number identification
11. Warranty
12. Precautions for use
13. Reliability test data
14. Outline drawing



KYOCERA CORPORATION
LCD DIVISION

This specification is subject to change without notice.
Consult Kyocera before ordering.

Original Issue Date	Designed by: Engineering dept.			Confirmed by: QA dept.	
	Prepared	Checked	Approved	Checked	Approved
June 24, 2011	M. Yamamoto	Y. Ikeda	M. Fujitani	I. Hamada	H. Sak

Spec No. TQ3C-8EAF0-E1YAC18-00	Part No. TCG121SVLPBANN-AN00	Page -
-----------------------------------	---------------------------------	-----------

Warning

1. This Kyocera LCD module has been specifically designed for use only in electronic devices and industrial machines in the area of audio control, office automation, industrial control, home appliances, etc. The module should not be used in applications where the highest level of safety and reliability are required and module failure or malfunction of such module results in physical harm or loss of life, as well as enormous damage or loss. Such fields of applications include, without limitation, medical, aerospace, communications infrastructure, atomic energy control. Kyocera expressly disclaims any and all liability resulting in any way to the use of the module in such applications.

2. Customer agrees to indemnify, defend and hold Kyocera harmless from and against any and all actions, claims, damages, liabilities, awards, costs, and expenses, including legal expenses, resulting from or arising out of Customer's use, or sale for use, or Kyocera modules in applications.

Caution

1. Kyocera shall have the right, which Customer hereby acknowledges, to immediately scrap or destroy tooling for Kyocera modules for which no Purchase Orders have been received from the Customer in a two-year period.

Spec No. TQ3C-8EAF0-E1YAC18-00	Part No. TCG121SVLPBANN-AN00	Page -
-----------------------------------	---------------------------------	-----------

Revision record

Date		Designed by : Engineering dept.			Confirmed by : QA dept.	
		Prepared	Checked	Approved	Checked	Approved
Rev.No.	Date	Page	Descriptions			

1. Application

This document defines the specification of TCG121SVLPBANN-AN00. (RoHS Compliant)

2. Construction and outline

LCD	: Transmissive color dot matrix type TFT
Backlight system	: LED
Polarizer	: Anti-Glare treatment
Additional circuit	: Timing controller, Power supply (3.3V input) (without constant current circuit for LED Backlight)

3. Mechanical specifications

Item	Specification	Unit
Outline dimensions 1)	278.3(W)×(207.5)(H)×9.5(D)	mm
Active area	246(W)×184.5(H) (30.8cm/12.1 inch(Diagonal))	mm
Dot format	800×(R,G,B)(W)×600(H)	dot
Dot pitch	0.1025(W)×0.3075(H)	mm
Base color 2)	Normally White	-
Mass	645	g

1) Projection not included. Please refer to outline for details.

2) Due to the characteristics of the LCD material, the color varies with environmental temperature.

4. Absolute maximum ratings

4-1. Electrical absolute maximum ratings

Item	Symbol	Min.	Max.	Unit
Supply voltage	V _{DD}	-0.3	4.0	V
Input signal voltage 1)	V _{IN}	-0.3	4.0	V
LED forward current 2)	I _F	-	100	V

1) Input signal : CK, R0 ~ R5, G0 ~ G5, B0 ~ B5, H_{SYNC}, V_{SYNC}, ENAB, SC

2) For each “AN-CA”

4-2. Environmental absolute maximum ratings

Item	Symbol	Min.	Max.	Unit
Operating temperature 1)	T _{OP}	-20	70	°C
Storage temperature 2)	T _{STO}	-30	80	°C
Operating humidity 3)	H _{OP}	10	4)	%RH
Storage humidity 3)	H _{STO}	10	4)	%RH
Vibration	-	5)	5)	-
Shock	-	6)	6)	-

1) Operating temperature means a temperature which operation shall be guaranteed. Since display performance is evaluated at 25°C, another temperature range should be confirmed.

2) Temp. = -30°C < 48h , Temp. = 80°C < 168h

Store LCD at normal temperature/humidity. Keep them free from vibration and shock.

An LCD that is kept at a low or a high temperature for a long time can be defective due to other conditions, even if the low or high temperature satisfies the standard.

(Please refer to “Precautions for Use” for details.)

3) Non-condensing

4) Temp. 40°C, 85%RH Max.

Temp. > 40°C, Absolute humidity shall be less than 85%RH at 40°C.

5)

Frequency	10 ~ 55 Hz	Acceleration value (0.3 ~ 9 m/s ²)
Vibration width	0.15mm	
Interval	10-55-10 Hz	1 minutes

2 hours in each direction X, Y, Z (6 hours total)

EIAJ ED-2531

6) Acceleration: 490 m/s², Pulse width: 11 ms

3 times in each direction: ±X, ±Y, ±Z

EIAJ ED-2531

5. Electrical characteristics

Temp. = -20 ~ 70°C

Item	Symbol	Condition	Min.	Typ.	Max.	Unit
Supply voltage 1)	V _{DD}	-	3.0	3.3	3.6	V
Current consumption	I _{DD}	2)	-	280	340	mA
Permissive input ripple voltage	V _{RP}	V _{DD} =3.3V	-	-	100	mVp-p
Input signal voltage 3)	V _{IL}	"Low" level	0	-	0.8	V
	V _{IH}	"High" level	2.0	-	V _{DD}	V
V _{DD} -turn-on conditions 1)	t1	-	0.1	-	10	ms
	t2	-	0	-	-	ms
	t3	-	0	-	-	ms
	t4	-	1.0	-	-	s
	t5	-	200	--	-	ms
	t6	-	200	-	-	ms

1) V_{DD}-turn-on conditions

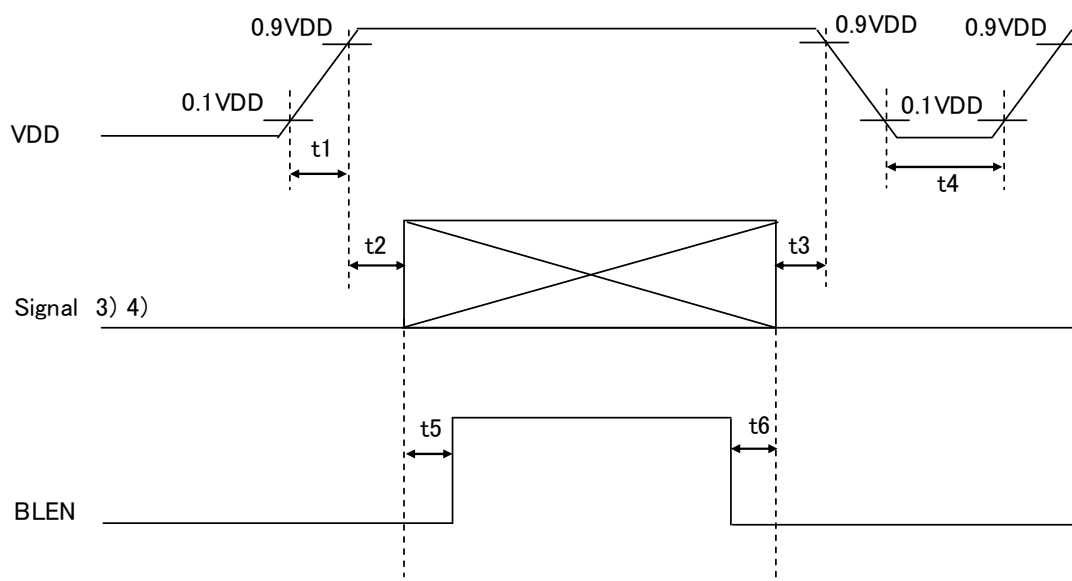

* If the condition of t5, t6 doesn't fill it, the display noise might be seen.

2) Display pattern:

V_{DD} = 3.3V, Temp. = 25°C

1 2 3 2398 2399 2400(dot)
 1
 2
 3
 :
 :
 :
 599
 600
 (dot)

3) Input signal : CK, R0 ~ R5, G0 ~ G5, B0 ~ B5, Hsync, Vsync, ENAB, SC

6. Optical characteristics

Measuring spot = 6.0mm, Temp. = 25°C

Item	Symbol	Condition	Min.	Typ.	Max.	Unit	
Response time	Rise	τ_r	= =0°	-	4	-	ms
	Down	τ_d	= =0°	-	22	-	ms
Viewing angle range View direction : 6 o'clock (Gray inversion)	UPPER	CR 10	= =0°	-	80	-	deg.
	LOWER			-	65	-	
	LEFT			-	80	-	deg.
	ϕ RIGHT			-	80	-	
Contrast ratio	CR	= =0°	700	1000	-	-	
Brightness	L	IF=60mA/Line	350	500	-	cd/m ²	
Chromaticity coordinates	Red	x	= =0°	0.560	0.610	0.660	-
		y		0.300	0.350	0.400	
	Green	x	= =0°	0.280	0.330	0.380	
		y		0.510	0.560	0.610	
	Blue	x	= =0°	0.100	0.150	0.200	
		y		0.070	0.120	0.170	
	White	x	= =0°	0.245	0.295	0.345	
		y		0.265	0.315	0.365	

6-1. Definition of contrast ratio

$$\text{CR(Contrast ratio)} = \frac{\text{Brightness with all pixels "White"}}{\text{Brightness with all pixels "Black"}}$$

6-2. Definition of response time

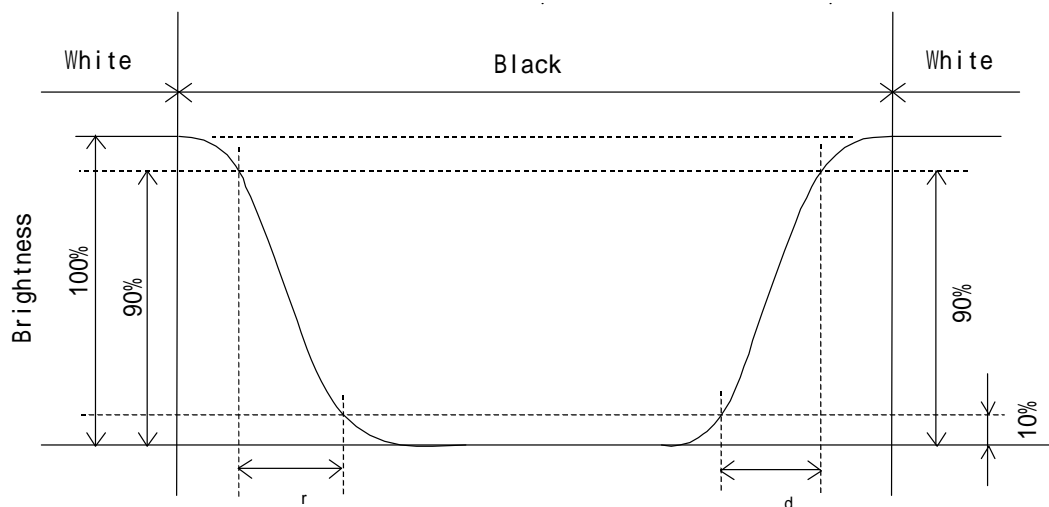

6-3. Definition of viewing angle

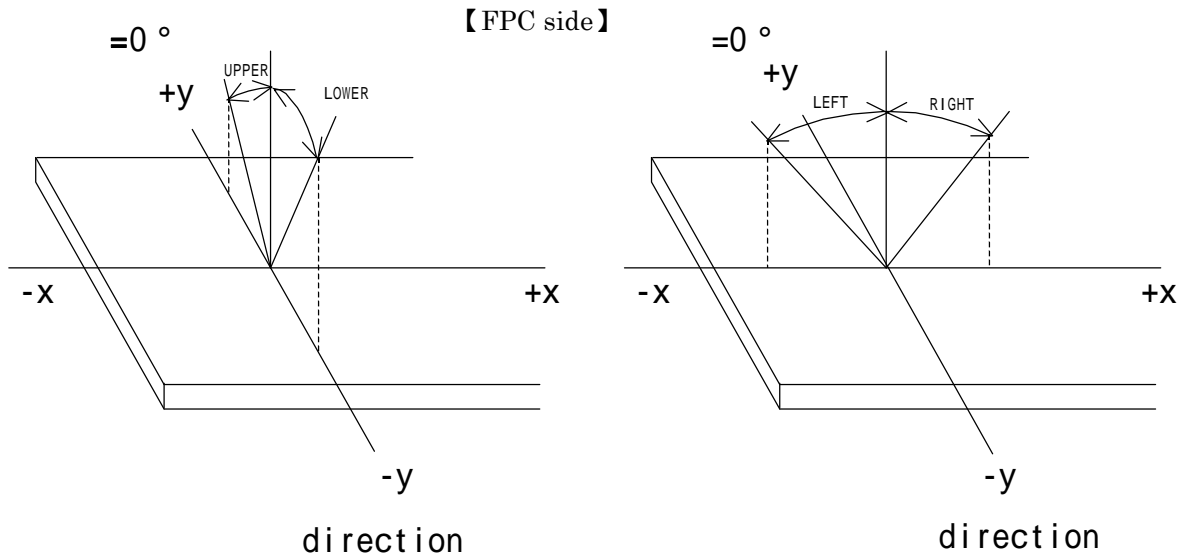

6-4. Brightness measuring points

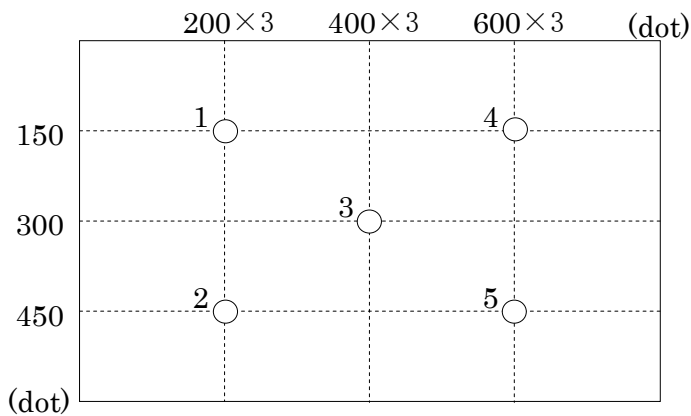

- 1) Rating is defined as the white brightness at center of display screen(3).
- 2) The brightness uniformity is calculated by using following formula.

$$\text{Brightness uniformity} = \frac{\text{Minimum brightness from 1 to 5}}{\text{Maximum brightness from 1 to 5}} \times 100 [\%]$$

- 3) 30 minutes after LED is turned on. (Ambient Temp.=25)

7. Interface signals

7-1. LED

No.	Symbol	Description	Note
1	SC	Scan direction control (GND or Open: Normal, High: Reverse)	1)
2	ENAB	Data Enable (positive)	
3	VSYNC	Vertical synchronous signal (negative)	
4	HSYNC	Horizontal synchronous signal (negative)	
5	GND	GND	
6	B5	BLUE data signal (MSB)	
7	B4	BLUE data signal	
8	B3	BLUE data signal	
9	B2	BLUE data signal	
10	B1	BLUE data signal	
11	B0	BLUE data signal (LSB)	
12	GND	GND	
13	G5	GREEN data signal (MSB)	
14	G4	GREEN data signal	
15	G3	GREEN data signal	
16	G2	GREEN data signal	
17	G1	GREEN data signal	
18	G0	GREEN data signal (LSB)	
19	GND	GND	
20	R5	RED data signal (MSB)	
21	R4	RED data signal	
22	R3	RED data signal	
23	R2	RED data signal	
24	R1	RED data signal	
25	R0	RED data signal (LSB)	
26	GND	GND	
27	CK	Sampling clock	
28	GND	GND	
29	V _{DD}	+3.3V power supply	
30	V _{DD}	+3.3V power supply	

LCD connector : 04 6240 030 026 846+ (ELCO)
 Recommended matching FFC or FPC : 0.5mm pitch

1) Scanning

SC : GND or Open

SC : High

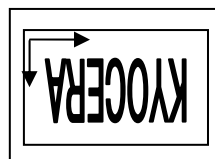
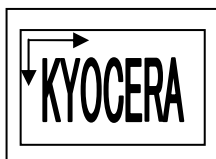

7-2. LED

No.	Symbol	Description	Note
1	AN1	Anode1	
2	AN2	Anode2	
3	AN3	Anode3	
4	CA3	Cathode3	
5	CA2	Cathode2	
6	CA1	Cathode1	

LED connector (CN2) : SM06B-SHLS-TF(LF)(SN) (JST)
 Matching connector : SHLP-06V-S-B (JST)

8. Input timing characteristics

8-1. DE mode

	Item	Symbol	Min.	Typ.	Max.	Unit	Note
Clock (CK)	Frequency	1/Tc	30	40	48	MHz	
	High time	Tch	4	-	-	ns	
	Low time	Tcl	2	-	-	ns	
Data (R0~R5, G0~G5, B0~B5)	Set up time	Tds	5	-	-	ns	
	Hold time	Tdh	5	-	-	ns	
Data Enable (ENAB)	Set up time	Tes	5	-	-	ns	
	Hold time	Teh	5	-	-	ns	
	Horizontal Period	Th	860	1056	1395	Tc	
			24.0	26.4	-	μs	1)
	Horizontal display period	Thd	800			Tc	
	Vertical Period	Tv	610	628	1024	Th	
Vertical display period	Tvd	600			Th		
Refresh rate		fv	50	60	70	Hz	2)

- 1) Please set a clock frequency, a vertical dormant period, and the horizontal dormant period so that the Horizontal Period should not reach less than Min. value.
- 2) If the refresh rate reach less than Min. value, the deterioration of the display quality, flicker etc., may occur.(fv=1/Tv)

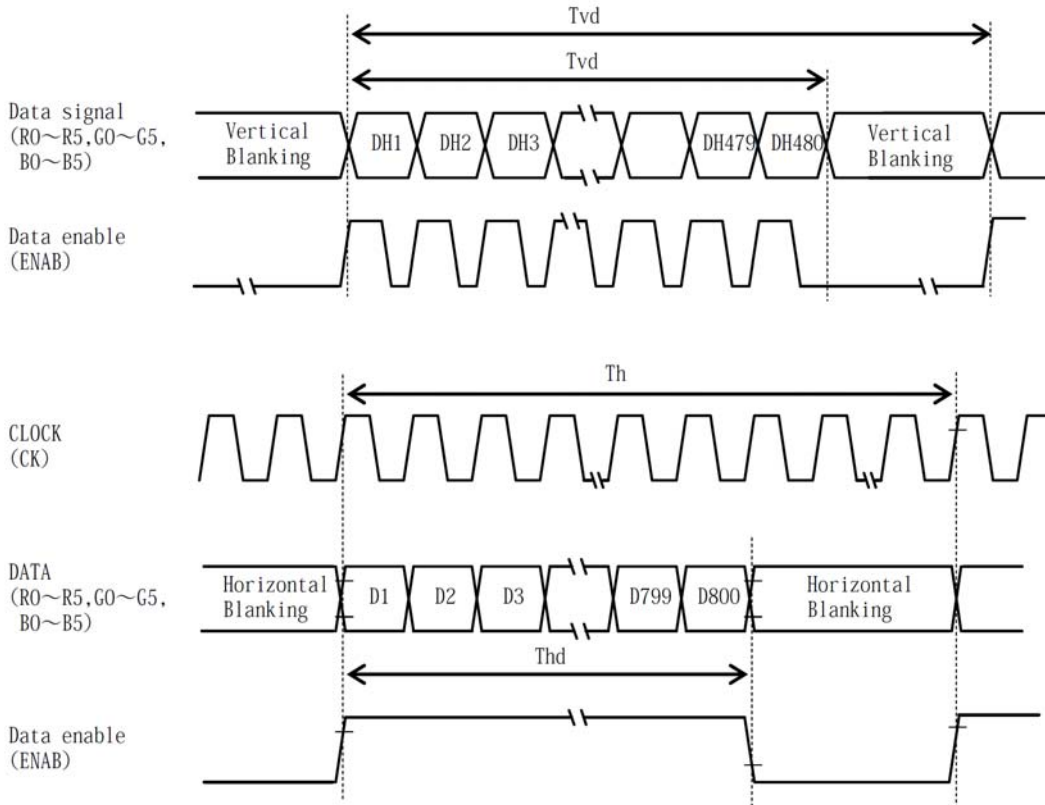
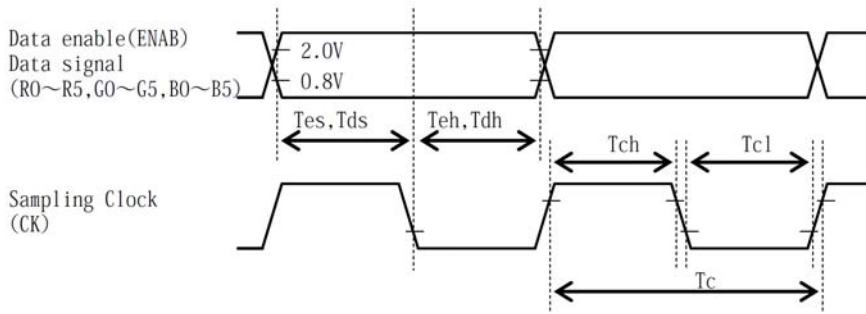

8-2 . SYNC mode

Item		Symbol	Min.	Typ.	Max.	Unit	Note
Clock (CK)	Frequency	1/Tc	30	40	48	MHz	
	High time	Tch	4	-	-	ns	
	Low time	Tcl	2	-	-	ns	
Data (R0 ~ R5,G0 ~ G5, B0 ~ B5)	Set up time	Tds	5	-	-	ns	
	Hold time	Tdh	5	-	-	ns	
Horizontal synchronous signal (H _{SYNC})	Set up time	Ths	5	-	-	ns	
	Hold time	Thh	5	-	-	ns	
	Period	Th	1017	1056	1395	Tc	
			24.0	26.4	-	μs	1)
	Front porch	Thf	1	40	379	Tc	
	Pulse width	Thp	4	128	212	Tc	2)
	Back porch	Thb	4	88	212	Tc	2)
Horizontal display period		Thd	800			Tc	
Vertical synchronous signal (V _{SYNC})	Set up time	Tvs	5	-	-	ns	
	Hold time	Tvh	5	-	-	ns	
	Period	Tv	628	628	1024	Th	
	Front porch	Tvf	1	1	397	Th	
	Pulse width	Tvp	2	4	25	Th	3)
	Back porch	Tvb	2	23	25	Th	3)
Vertical display period		Tvd	600			Th	
Refresh rate		fv	50	60	70	Hz	4)
Synchronous signal phase lag		Ths2vs	0	0	100	ns	5)

- 1) Please set a clock frequency, a vertical dormant period, and the horizontal dormant period so that the Horizontal Period should not reach less than Min. value.
- 2) $Thb + Thp = 216$
- 3) $Tvb + Tvp = 27$
- 4) If the refresh rate reach less than Min. value, the deterioration of the display quality, flicker etc.,may occur.($fv=1/Tv$)
- 5) V_{SYNC} must not stand up earlier than H_{SYNC}.

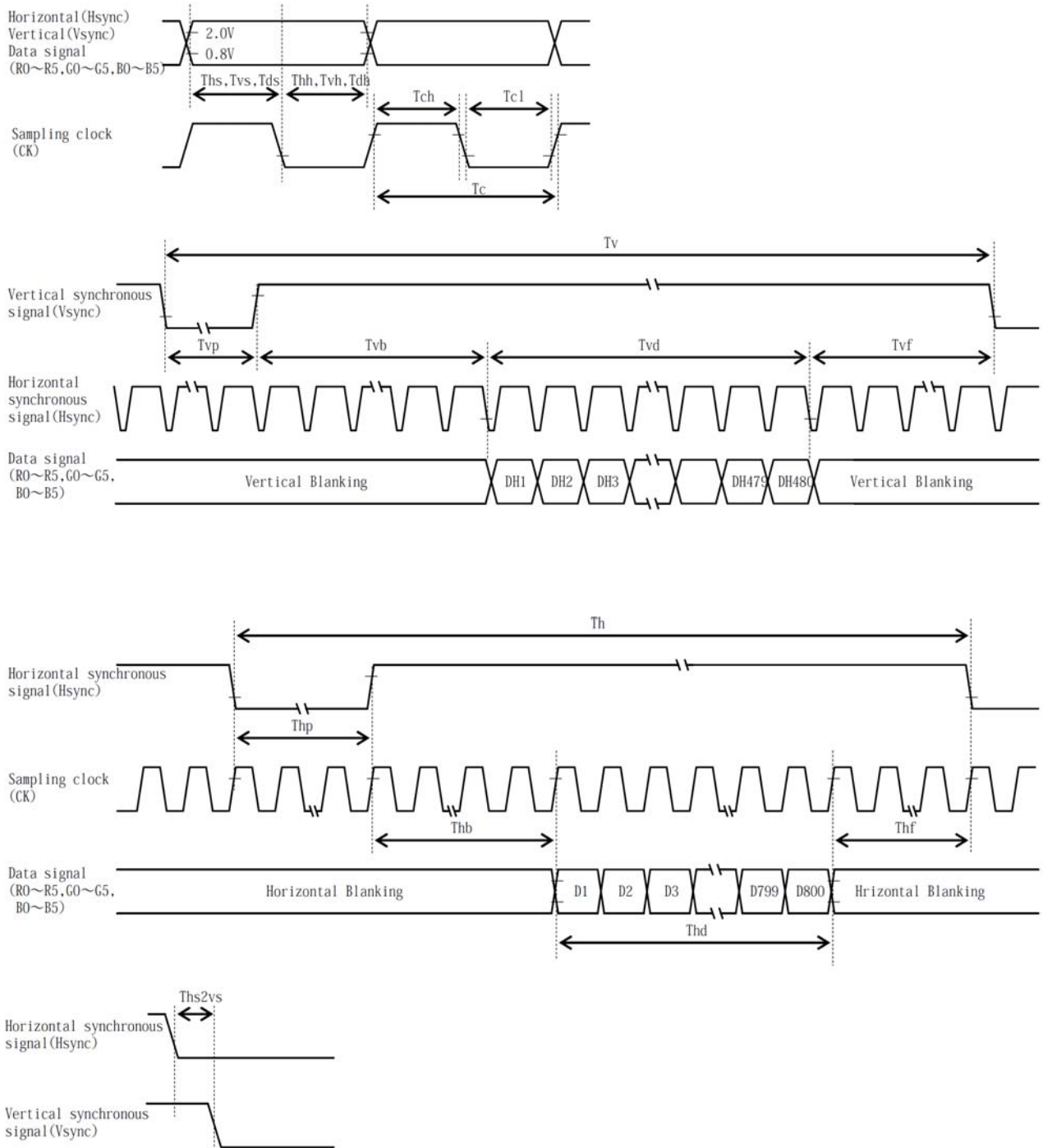

8-3 . Input Data Signals and Display position on the screen.

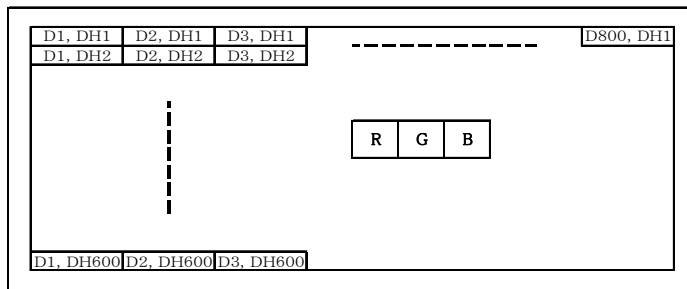

9 . Backlight system

Item	Symbol	Min.	Typ.	Max.	Unit	Note
Forward current 1)	IF	-	60	-	mA	Ta=-20 ~ 70
Forward voltage 1)	VF	-	22.0	25.8	V	IF=60mA, Ta=-20
		-	21.0	24.7	V	IF=60mA, Ta=25
		-	20.4	24.1	V	IF=60mA, Ta=70
Operating life time 2), 3)	T	-	70,000	-	h	IF=60mA, Ta=25

- 1) For each " AN-CA "
- 2) When brightness decrease 50% of minimum brightness.
The average life of a LED will decrease when the LCD is operating at higher temperatures.
- 3) Life time is estimated data. (Condition : IF=60mA, Ta=25°C in chamber).
- 4) An input current below 15mA may reduce the brightness uniformity of the LED backlight.
This is because the amount of light from each LED chip is different. Therefore, please evaluate carefully before finalizing the input current.

10. Lot number identification

The lot number shall be indicated on the back of the backlight case of each LCD.

TCG121SVLPBANN-AN00 - □□ - □□ - □ MADE IN □□□□□
 ↓↓ ↓ ↓ ↓ ↓
 1 2 3 4 5

No1. - No5. above indicate
 1. Year code
 2. Month code
 3. Date
 4. Version Number
 5. Country of origin (Japan or China)

Year	2011	2012	2013	2014	2015	2016
Code	1	2	3	4	5	6

Month	Jan.	Feb.	Mar.	Apr.	May	Jun.
Code	1	2	3	4	5	6

Month	Jul.	Aug.	Sep.	Oct.	Nov.	Dec.
Code	7	8	9	X	Y	Z

11. Warranty

11-1. Incoming inspection

Please inspect the LCD within one month after your receipt.

11-2. Production warranty

Kyocera warrants its LCD's for a period of 12 months from the ship date. Kyocera shall, by mutual agreement, replace or re-work defective LCD's that are shown to be Kyocera's responsibility.

Spec No.	Part No.	Page
TQ3C-8EAF0-E1YAC18-00	TCG121SVLPBANN-AN00	14

12. Precautions for use

12-1. Installation of the LCD

- 1) Please ground either of the mounting (screw) holes located at each corner of an LCD, in order to stabilize brightness and display quality.
- 2) A transparent protection plate shall be added to protect the LCD and its polarizer.
- 3) The LCD shall be installed so that there is no pressure on the LSI chips.
- 4) The LCD shall be installed flat, without twisting or bending.
- 5) A transparent protection sheet is attached to the polarizer. Please remove the protection film slowly before use, paying attention to static electricity.

12-2. Static electricity

- 1) Since CMOS ICs are mounted directly onto the LCD glass, protection from static electricity is required.
- 2) Workers should use body grounding. Operator should wear ground straps.

12-3. LCD operation

- 1) The LCD shall be operated within the limits specified. Operation at values outside of these limits may shorten life, and/or harm display images.

12-4. Storage

- 1) The LCD shall be stored within the temperature and humidity limits specified.
Store in a dark area, and protect the LCD from direct sunlight or fluorescent light.
- 2) Always store the LCD so that it is free from external pressure onto it.

12-5. Usage

- 1) **DO NOT** store in a high humidity environment for extended periods. Polarizer degradation bubbles, and/or peeling off of the polarizer may result.
- 2) The front polarizer is easily scratched or damaged. Prevent touching it with any hard material, and from being pushed or rubbed.
- 3) The LCD screen may be cleaned by wiping the screen surface with a soft cloth or cotton pad using a little Ethanol.
- 4) Water may cause damage or discoloration of the polarizer. Clean condensation or moisture from any source immediately.
- 5) Always keep the LCD free from condensation during testing. Condensation may permanently spot or stain the polarizer.
- 6) Do not disassemble LCD because it will result in damage.
- 7) This Kyocera LCD has been specifically designed for use in general electronic devices, but not for use in a special environment such as usage in an active gas. Hence, when the LCD is supposed to be used in a special environment, evaluate the LCD thoroughly beforehand and do not expose the LCD to chemicals such as an active gas.
- 8) Please do not use solid-base image pattern for long hours because a temporary afterimage may appear. We recommend using screen saver etc. in cases where a solid-base image pattern must be used.
- 9) Liquid crystal may leak when the LCD is broken. Be careful not to let the fluid go into your eyes and mouth. In the case the fluid touches your body; rinse it off right away with water and soap.

13. Reliability test data

Test item	Test condition	Test time	Judgement
High temp. atmosphere	80°C	240h	Display function : no defect Display quality : no defect Current consumption : no defect
Low temp. atmosphere	-30°C	240h	Display function : no defect Display quality : no defect Current consumption : no defect
High temp. humidity atmosphere	40°C 90% RH	240h	Display function : no defect Display quality : no defect Current consumption : no defect
Temp. cycle	-30°C 0.5h R.T. 0.5h 80°C 0.5h	10cycles	Display function : no defect Display quality : no defect Current consumption : no defect
High temp. operation	70°C	500h	Display function : no defect Display quality : no defect Current consumption : no defect

- 1) Each test item uses a test LCD only once. The tested LCD is not used in any other tests.
- 2) The LCD is tested in circumstances in which there is no condensation.
- 3) The reliability test is not an out-going inspection.
- 4) The result of the reliability test is for your reference purpose only.
The reliability test is conducted only to examine the LCD's capability.

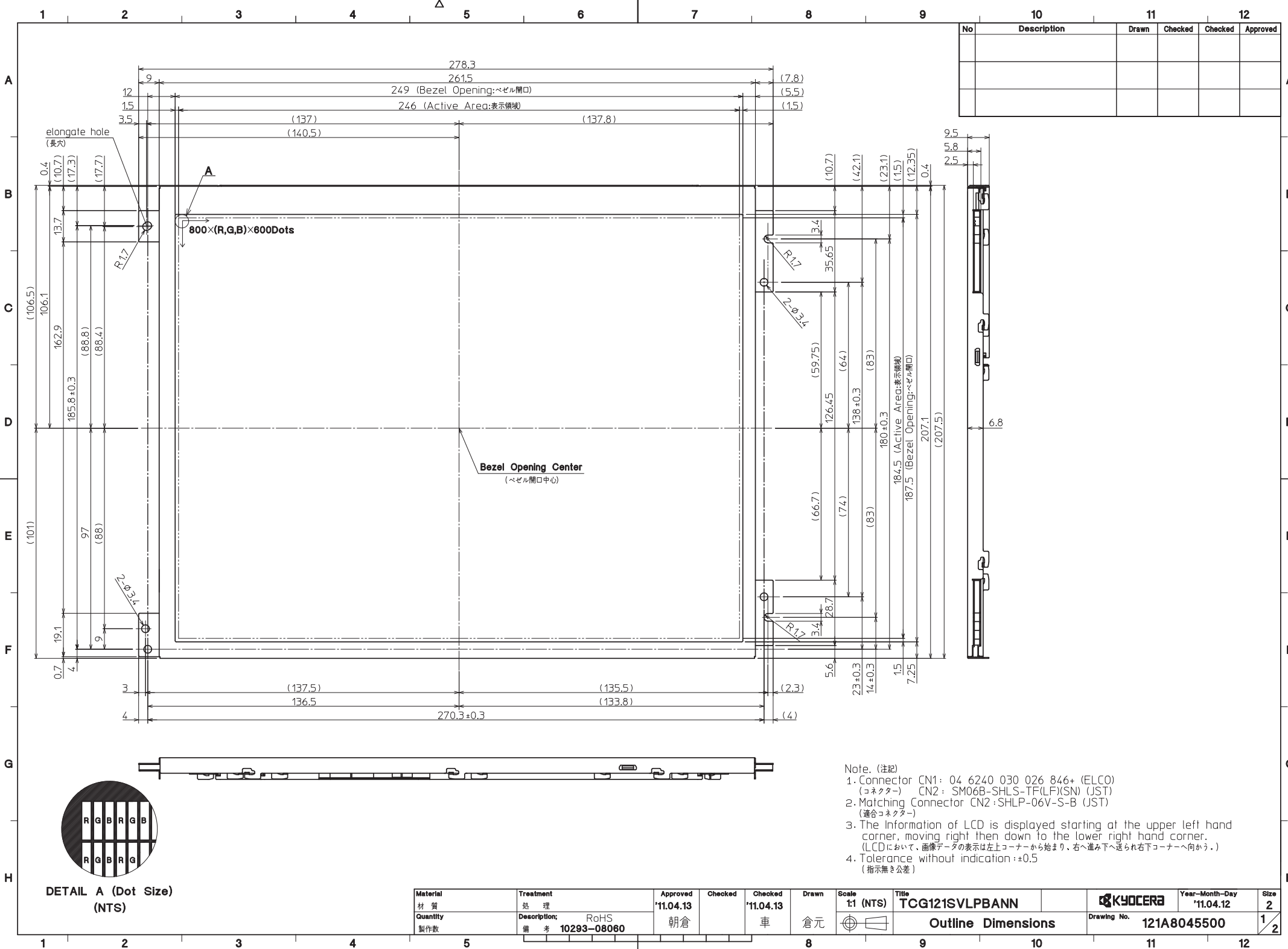

No	Description	Drawn	Checked	Checked	Approved



DETAIL A (Dot Size)
(NTS)

- Note. (注記)
1. Connector CN1: 04 6240 030 026 846+ (ELCO) (コネクタ) CN2: SM06B-SHLS-TF(LF)(SN) (JST)
 2. Matching Connector CN2: SHLP-06V-S-B (JST) (適合コネクタ)
 3. The Information of LCD is displayed starting at the upper left hand corner, moving right then down to the lower right hand corner. (LCDにおいて、画像データの表示は左上コーナーから始まり、右へ進み下へ送られ右下コーナーへ向かう。)
 4. Tolerance without indication: ±0.5 (指示無き公差)

Material 材質	Treatment 処理	Approved '11.04.13	Checked	Checked '11.04.13	Drawn 倉元	Scale 1:1 (NTS)	Title TCG121SVLPBANN	KYOCERA	Year-Month-Day '11.04.12	Size 2
Quantity 製作数	Description 備考	RoHS 10293-08060	朝倉	車	倉元	Outline Dimensions	Drawing No. 121A8045500		1	2

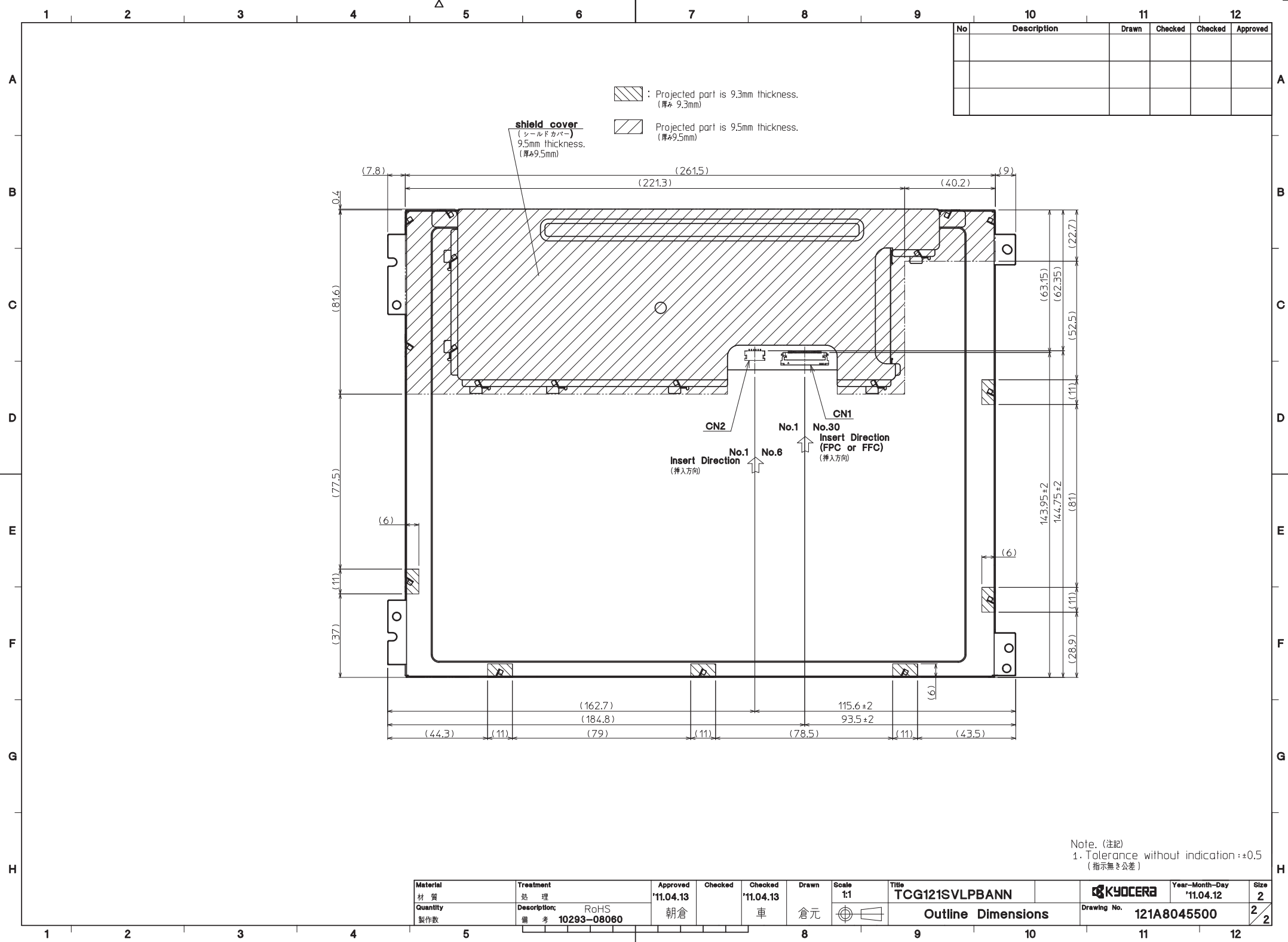

No	Description	Drawn	Checked	Checked	Approved

Note. (注記)
 1. Tolerance without indication : ±0.5
 (指示無き公差)

Material 材質	Treatment 処理	Approved '11.04.13	Checked	Checked '11.04.13	Drawn 倉元	Scale 1:1	Title TCG121SVLPBANN	KYOCERA	Year-Month-Day '11.04.12	Size 2
Quantity 製作数	Description 備考 RoHS 10293-08060	朝倉	車	倉元	⊕	Outline Dimensions	Drawing No. 121A8045500		2	

Spec No.	TQ3C-8EAF0-E2YAC18-00
Date	June 24, 2011

KYOCERA INSPECTION STANDARD

TYPE : TCG121SVLPBANN-AN00

KYOCERA CORPORATION
LCD DIVISION

Original Issue Date	Designed by : Engineering dept.			Confirmed by : QA dept.	
	Prepared	Checked	Approved	Checked	Approved
June 24, 2011	M. Yamamoto	<i>Y. Ikeda</i>	M. Fujitani	<i>I. Hamada</i>	<i>T. Ito</i>

Spec No.
TQ3C-8EAF0-E2YAC18-00

Part No.
TCG121SVLPBANN-AN00

Page
-

Revision record

Date		Designed by : Engineering dept.			Confirmed by : QA dept.	
		Prepared	Checked	Approved	Checked	Approved
Rev.No.	Date	Page	Descriptions			

Visuals specification

1) Note

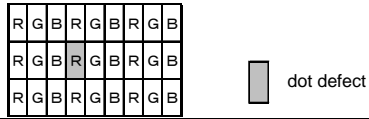
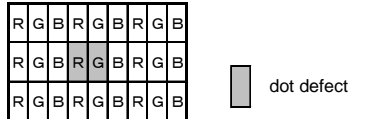
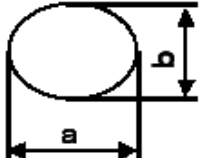
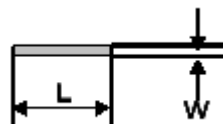
	Note	
General	<p>1. Customer identified anomalies not defined within this inspection standard shall be reviewed by Kyocera, and an additional standard shall be determined by mutual consent.</p> <p>2. This inspection standard about the image quality shall be applied to any defect within the active area and shall not be applicable to outside of the area.</p> <p>3. Inspection conditions</p> <p>Luminance : 500 Lux min.</p> <p>Inspection distance : 300 mm.</p> <p>Temperature : 25 ± 5</p> <p>Direction : Directly above</p>	
Definition of inspection item	Dot defect	<p>Bright dot defect</p> <p>The dot is constantly “on” when power applied to the LCD, even when all “Black” data sent to the screen. Inspection tool: 5% Transparency neutral density filter. Count dot: If the dot is visible through the filter. Don't count dot: If the dot is not visible through the filter.</p> 
		<p>Black dot defect</p> <p>The dot is constantly “off” when power applied to the LCD, even when all “White” data sent to the screen.</p>
		<p>Adjacent dot</p> <p>Adjacent dot defect is defined as two or more bright dot defects or black dot defects.</p> 
	External inspection	<p>Bubble, Scratch, Foreign particle (Polarizer, Cell, Backlight)</p> <p>Visible operating (all pixels “Black” or “White”) and non operating.</p>
		<p>Appearance inspection</p> <p>Does not satisfy the value at the spec.</p>
	Others	<p>LED wires</p> <p>Damaged to the LED wires, connector, pin, functional failure or appearance failure.</p>
	Definition of size	<p>Definition of circle size</p>  <p>$d = (a + b) / 2$</p> <p>Definition of linear size</p> 

2) Standard

Classification		Inspection item	Judgement standard																										
Defect (in LCD glass)	Dot defect	Bright dot defect	Acceptable number : 4 Bright dot spacing : 5 mm or more																										
		Black dot defect	Acceptable number : 5 Black dot spacing : 5 mm or more																										
		2 dot join	Bright dot defect	Acceptable number : 2																									
			Black dot defect	Acceptable number : 3																									
		3 or more dots join	Acceptable number : 0																										
		Total dot defects	Acceptable number : 5 Max																										
	Others	White dot, Dark dot (Circle)	<table border="1"> <thead> <tr> <th colspan="2">Size (mm)</th> <th>Acceptable number</th> </tr> </thead> <tbody> <tr> <td>d</td> <td>0.2</td> <td>(Neglected)</td> </tr> <tr> <td>0.2 < d</td> <td>0.4</td> <td>5</td> </tr> <tr> <td>0.4 < d</td> <td>0.5</td> <td>3</td> </tr> <tr> <td>0.5 < d</td> <td></td> <td>0</td> </tr> </tbody> </table>			Size (mm)		Acceptable number	d	0.2	(Neglected)	0.2 < d	0.4	5	0.4 < d	0.5	3	0.5 < d		0									
Size (mm)		Acceptable number																											
d	0.2	(Neglected)																											
0.2 < d	0.4	5																											
0.4 < d	0.5	3																											
0.5 < d		0																											
External inspection (Defect on Polarizer or between Polarizer and LCD glass)	Polarizer (Scratch)	<table border="1"> <thead> <tr> <th colspan="2">Width (mm)</th> <th colspan="2">Length (mm)</th> <th>Acceptable number</th> </tr> </thead> <tbody> <tr> <td>W</td> <td>0.1</td> <td colspan="2">-</td> <td>(Neglected)</td> </tr> <tr> <td rowspan="2">0.1 < W</td> <td rowspan="2">0.3</td> <td colspan="2">L 5.0</td> <td>(Neglected)</td> </tr> <tr> <td colspan="2">5.0 < L</td> <td>0</td> </tr> <tr> <td colspan="2">0.3 < W</td> <td colspan="2">-</td> <td>0</td> </tr> </tbody> </table>			Width (mm)		Length (mm)		Acceptable number	W	0.1	-		(Neglected)	0.1 < W	0.3	L 5.0		(Neglected)	5.0 < L		0	0.3 < W		-		0		
		Width (mm)		Length (mm)		Acceptable number																							
		W	0.1	-		(Neglected)																							
		0.1 < W	0.3	L 5.0		(Neglected)																							
	5.0 < L			0																									
	0.3 < W		-		0																								
	Polarizer (Bubble)	<table border="1"> <thead> <tr> <th colspan="2">Size (mm)</th> <th>Acceptable number</th> </tr> </thead> <tbody> <tr> <td>d</td> <td>0.2</td> <td>(Neglected)</td> </tr> <tr> <td>0.2 < d</td> <td>0.3</td> <td>5</td> </tr> <tr> <td>0.3 < d</td> <td>0.5</td> <td>3</td> </tr> <tr> <td>0.5 < d</td> <td></td> <td>0</td> </tr> </tbody> </table>			Size (mm)		Acceptable number	d	0.2	(Neglected)	0.2 < d	0.3	5	0.3 < d	0.5	3	0.5 < d		0										
		Size (mm)		Acceptable number																									
		d	0.2	(Neglected)																									
		0.2 < d	0.3	5																									
0.3 < d	0.5	3																											
0.5 < d		0																											
Foreign particle (Circular shape)	<table border="1"> <thead> <tr> <th colspan="2">Size (mm)</th> <th>Acceptable number</th> </tr> </thead> <tbody> <tr> <td>d</td> <td>0.2</td> <td>(Neglected)</td> </tr> <tr> <td>0.2 < d</td> <td>0.4</td> <td>5</td> </tr> <tr> <td>0.4 < d</td> <td>0.5</td> <td>3</td> </tr> <tr> <td>0.5 < d</td> <td></td> <td>0</td> </tr> </tbody> </table>			Size (mm)		Acceptable number	d	0.2	(Neglected)	0.2 < d	0.4	5	0.4 < d	0.5	3	0.5 < d		0											
	Size (mm)		Acceptable number																										
	d	0.2	(Neglected)																										
	0.2 < d	0.4	5																										
0.4 < d	0.5	3																											
0.5 < d		0																											
Foreign particle (Linear shape) Scratch	<table border="1"> <thead> <tr> <th colspan="2">Width (mm)</th> <th colspan="2">Length (mm)</th> <th>Acceptable number</th> </tr> </thead> <tbody> <tr> <td>W</td> <td>0.03</td> <td colspan="2">-</td> <td>(Neglected)</td> </tr> <tr> <td rowspan="3">0.03 < W</td> <td rowspan="3">0.1</td> <td colspan="2">L 2.0</td> <td>(Neglected)</td> </tr> <tr> <td colspan="2">2.0 < L 4.0</td> <td>3</td> </tr> <tr> <td colspan="2">4.0 < L</td> <td>0</td> </tr> <tr> <td colspan="2">0.1 < W</td> <td colspan="2">-</td> <td>(According to circular shape)</td> </tr> </tbody> </table>			Width (mm)		Length (mm)		Acceptable number	W	0.03	-		(Neglected)	0.03 < W	0.1	L 2.0		(Neglected)	2.0 < L 4.0		3	4.0 < L		0	0.1 < W		-		(According to circular shape)
	Width (mm)		Length (mm)		Acceptable number																								
	W	0.03	-		(Neglected)																								
	0.03 < W	0.1	L 2.0		(Neglected)																								
			2.0 < L 4.0		3																								
4.0 < L			0																										
0.1 < W		-		(According to circular shape)																									



Компания «ЭлектроПласт» предлагает заключение долгосрочных отношений при поставках импортных электронных компонентов на взаимовыгодных условиях!

Наши преимущества:

- Оперативные поставки широкого спектра электронных компонентов отечественного и импортного производства напрямую от производителей и с крупнейших мировых складов;
- Поставка более 17-ти миллионов наименований электронных компонентов;
- Поставка сложных, дефицитных, либо снятых с производства позиций;
- Оперативные сроки поставки под заказ (от 5 рабочих дней);
- Экспресс доставка в любую точку России;
- Техническая поддержка проекта, помощь в подборе аналогов, поставка прототипов;
- Система менеджмента качества сертифицирована по Международному стандарту ISO 9001;
- Лицензия ФСБ на осуществление работ с использованием сведений, составляющих государственную тайну;
- Поставка специализированных компонентов (Xilinx, Altera, Analog Devices, Intersil, Interpoint, Microsemi, Aeroflex, Peregrine, Syfer, Eurofarad, Texas Instrument, Miteq, Cobham, E2V, MA-COM, Hittite, Mini-Circuits, General Dynamics и др.);

Помимо этого, одним из направлений компании «ЭлектроПласт» является направление «Источники питания». Мы предлагаем Вам помощь Конструкторского отдела:

- Подбор оптимального решения, техническое обоснование при выборе компонента;
- Подбор аналогов;
- Консультации по применению компонента;
- Поставка образцов и прототипов;
- Техническая поддержка проекта;
- Защита от снятия компонента с производства.



Как с нами связаться

Телефон: 8 (812) 309 58 32 (многоканальный)

Факс: 8 (812) 320-02-42

Электронная почта: org@eplast1.ru

Адрес: 198099, г. Санкт-Петербург, ул. Калинина, дом 2, корпус 4, литера А.