

# HLMP-Cx1A/1B/2A/2B/3A/3B

## New 5mm Blue and Green LED Lamps



## Data Sheet



### Description

These high intensity blue and green T-1 $\frac{3}{4}$  package LEDs are untinted and non-diffused. Based on the most efficient and cost effective InGaN material technology and incorporating second generation optics they produce well defined spatial radiation patterns at specific viewing cone angles.

Advanced optical grade epoxy construction offers superior high temperature and moisture resistance performance in outdoor signal and sign applications. The epoxy contains UV inhibitor to reduce the effects of long term exposure to direct sunlight.

### Features

- Well defined spatial radiation pattern
- High luminous output
- Untinted, Non-diffused
- Available in Color:
  - Blue 470nm
  - Green 525nm
- Viewing Angle: 15°, 23° and 30°
- Standoff or non-standoff
- Superior resistance to moisture

### Applications

- Commercial outdoor advertising
- Traffic Sign
- Variable Message Sign

**CAUTION:** InGaN devices are Class 1C HBM ESD sensitive per JEDEC Standard. Please observe appropriate precautions during handling and processing. Refer to Application Note AN – 1142 for additional details.

## Package Dimensions

### Drawing A (Non-standoff)

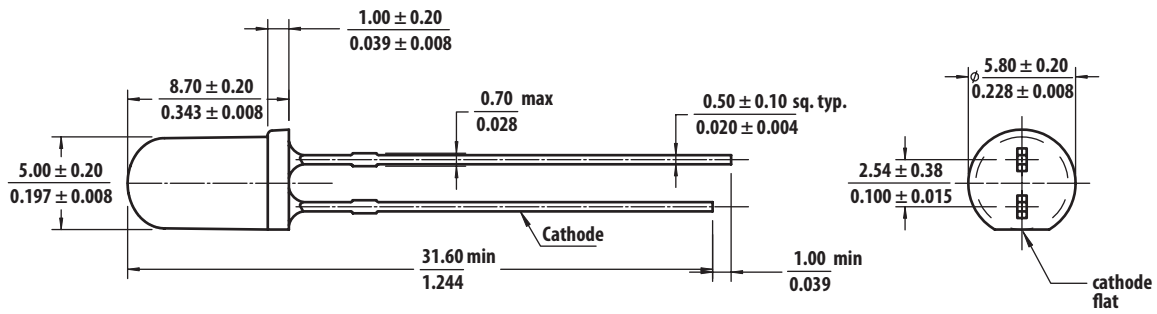

### Drawing B (Standoff)

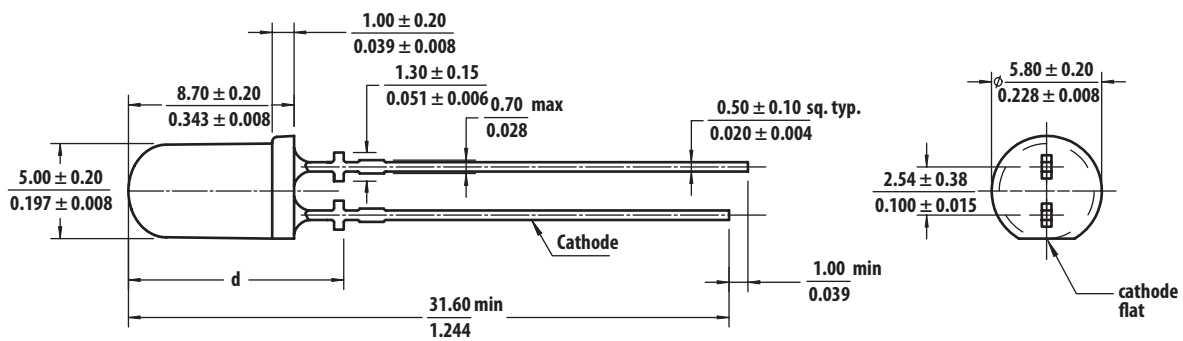

Viewing Angle	d
HLMP-Cx1B	12.96 ± 0.25 (0.510 ± 0.010)
HLMP-Cx2B	12.32 ± 0.25 (0.485 ± 0.010)
HLMP-Cx3B	12.00 ± 0.25 (0.472 ± 0.010)

#### Notes:

1. All dimensions are in millimeters (inches)
2. Leads are mild steel with tin plating.
3. The epoxy meniscus is 1.50mm max

## Device Selection Guide

Part Number	Color	Typical Viewing angle, $2\theta_{1/2}$ (°) [4]	Luminous Intensity $I_v$ (mcd) at 20 mA [1,2,5]		Standoff / Non Standoff	Package drawing			
			Min	Max					
HLMP-CB1A-XY0DD	Blue	15°	7200	12000	Non Standoff	A			
HLMP-CB1A-XYBDD									
HLMP-CB1A-XYCDD									
HLMP-CB1B-XY0DD					Standoff	B			
HLMP-CB1B-XYBDD									
HLMP-CB1B-XYCDD									
HLMP-CB2A-VW0DD		23°	4200	7200	Non Standoff	A			
HLMP-CB2A-VWBDD									
HLMP-CB2A-VWCDD									
HLMP-CB2B-VW0DD					Standoff	B			
HLMP-CB2B-VWBDD									
HLMP-CB2B-VWCDD									
HLMP-CB3A-UV0DD		30°	3200	5500	Non Standoff	A			
HLMP-CB3A-UVBDD									
HLMP-CB3A-UVCDD									
HLMP-CB3B-UV0DD					Standoff	B			
HLMP-CB3B-UVBDD									
HLMP-CB3B-UVCDD									
HLMP-CM1A-560DD	Green	15°	45000	76000	Non Standoff	A			
HLMP-CM1B-560DD					Standoff	B			
HLMP-CM2A-230DD					23°	21000	35000	Non Standoff	A
HLMP-CM2B-230DD								Standoff	B
HLMP-CM3A-Z10DD					30°	12000	21000	Non Standoff	A
HLMP-CM3A-Z1BDD									
HLMP-CM3A-Z1CDD									
HLMP-CM3B-Z10DD	Standoff	B							
HLMP-CM3B-Z1BDD									
HLMP-CM3B-Z1CDD									

### Notes:

1. The luminous intensity is measured on the mechanical axis of the lamp package and it is tested with pulsing condition.
2. The optical axis is closely aligned with the package mechanical axis.
3. Dominant wavelength,  $\lambda_d$ , is derived from the CIE Chromaticity Diagram and represents the color of the lamp.
4.  $\theta_{1/2}$  is the off-axis angle where the luminous intensity is half the on-axis intensity.
5. Tolerance for each bin limit is  $\pm 15\%$

## Part Numbering System

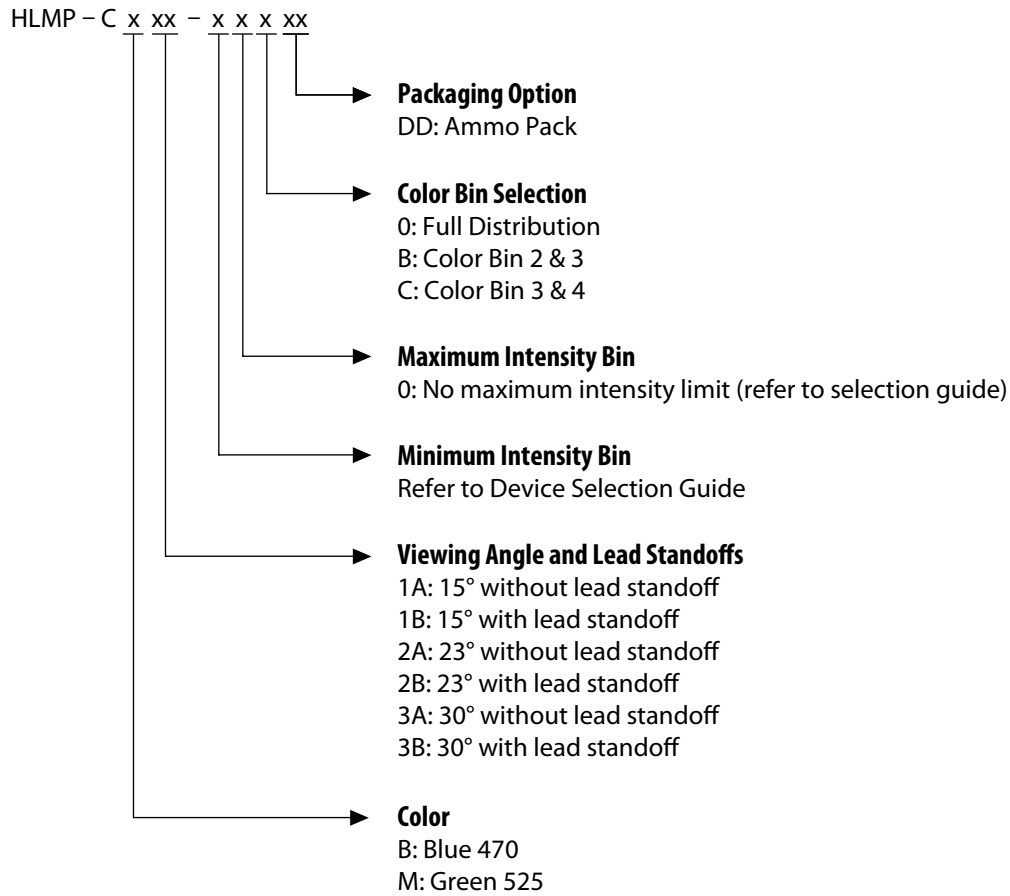

Note: please refer to AB 5337 for complete information on part numbering system

## Absolute Maximum Ratings

$T_J = 25^\circ\text{C}$

Parameter	Blue / Green	Unit
DC Forward Current <sup>[1]</sup>	30	mA
Peak Forward Current	100 <sup>[2]</sup>	mA
Power Dissipation	116	mW
Reverse Voltage	5	V
LED Junction Temperature	110	°C
Operating Temperature Range	-40 to + 85	°C
Storage Temperature Range	-40 to + 100	°C

Notes:

1. Derate linearly as shown in figure 4.
2. Duty Factor 10%, frequency 1KHz.

## Electrical / Optical Characteristics

$T_J = 25^\circ\text{C}$

Parameter	Symbol	Min.	Typ.	Max.	Units	Test Conditions
Forward Voltage Green / Blue	$V_F$	2.8	3.2	3.8	V	$I_F = 20\text{ mA}$
Reverse Voltage	$V_R$	5			V	$I_R = 10\ \mu\text{A}$
Dominant Wavelength <sup>[1]</sup> Green Blue	$\lambda_d$	519.0 460.0	525.0 470.0	539.0 480.0	nm	$I_F = 20\text{ mA}$
Peak Wavelength Green Blue	$\lambda_{PEAK}$		516 464		nm	Peak of Wavelength of Spectral Distribution at $I_F = 20\text{ mA}$
Spectral Half Width Green Blue	$\Delta\lambda_{1/2}$		30 23		nm	$I_F = 20\text{ mA}$
Thermal Resistance	$R\theta_{J-PIN}$		240		$^\circ\text{C}/\text{W}$	LED Junction-to-Pin
Luminous Efficacy <sup>[2]</sup> Green Blue	$\eta_V$		518 78		lm/W	Emitted Luminous Flux / Emitted Radiant Flux
Thermal coefficient of $\lambda_d$ Green Blue			0.028 0.024		nm/ $^\circ\text{C}$	$I_F = 20\text{ mA}$ ; $+25^\circ\text{C} \leq T_J \leq +100^\circ\text{C}$

Notes:

1. The dominant wavelength is derived from the chromaticity Diagram and represents the color of the lamp
2. The radiant intensity,  $I_e$  in watts per steradian, may be found from the equation  $I_e = I_V/\eta_V$  where  $I_V$  is the luminous intensity in candelas and  $\eta_V$  is the luminous efficacy in lumens/watt.

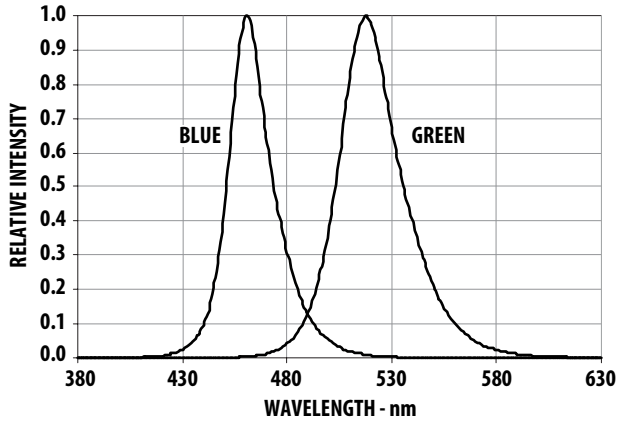

Figure 1. Relative Intensity vs Wavelength

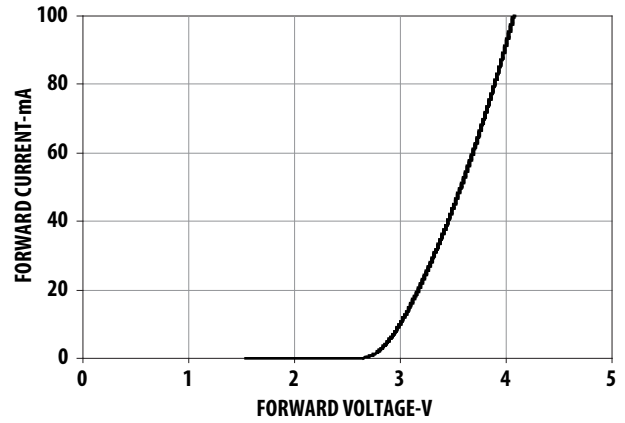

Figure 2. Forward Current vs Forward Voltage

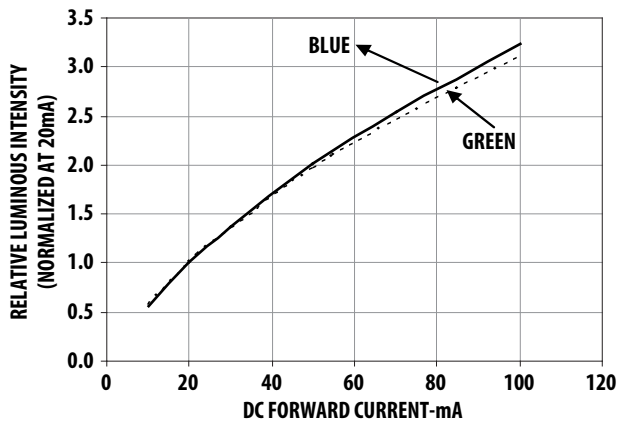

Figure 3. Relative Intensity vs Forward Current

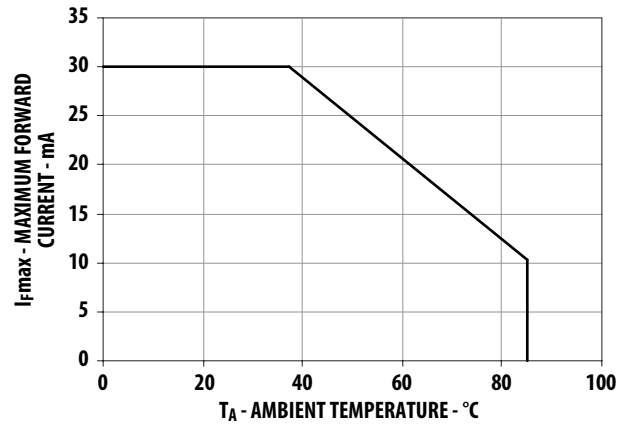

Figure 4. Maximum Forward Current vs Ambient Temperature

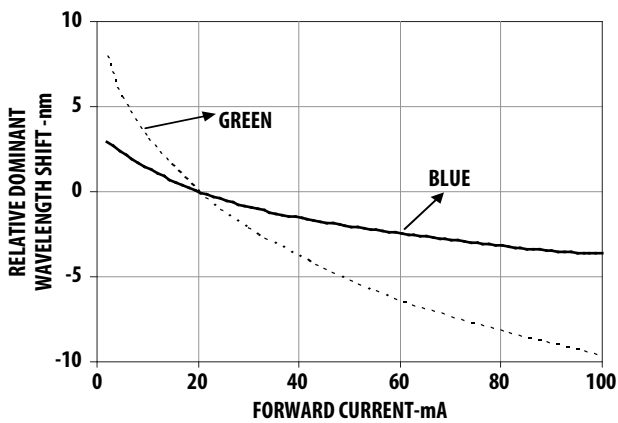

Figure 5. Relative Dominant Wavelength Shift vs Forward Current

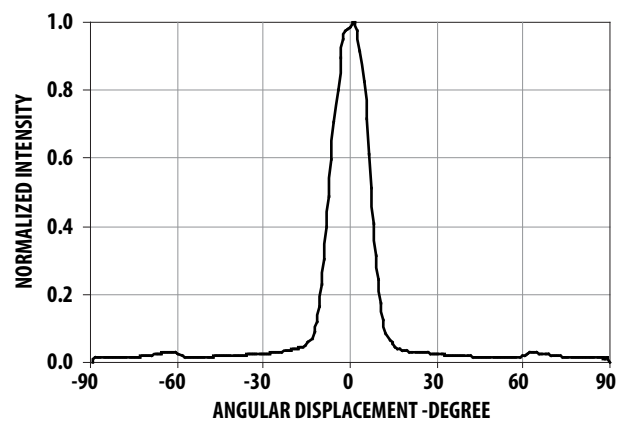

Figure 6. Radiation Pattern for 15°

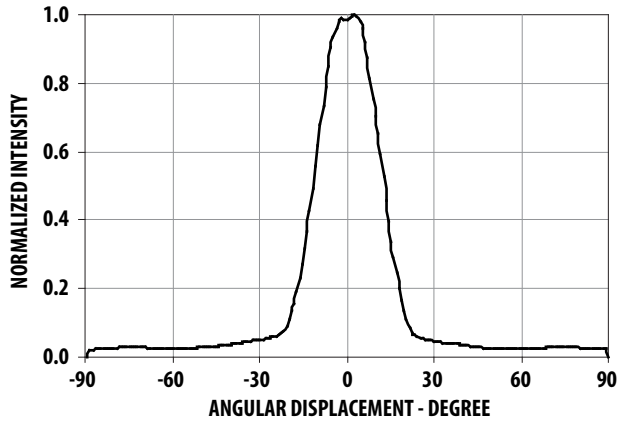

Figure 7. Radiation Pattern for 23°

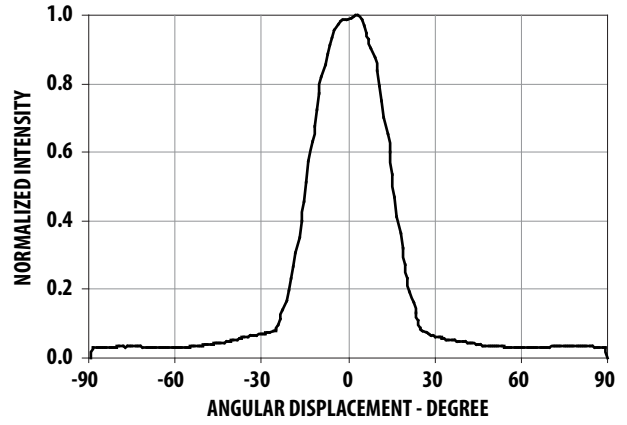

Figure 8. Radiation Pattern for 30°

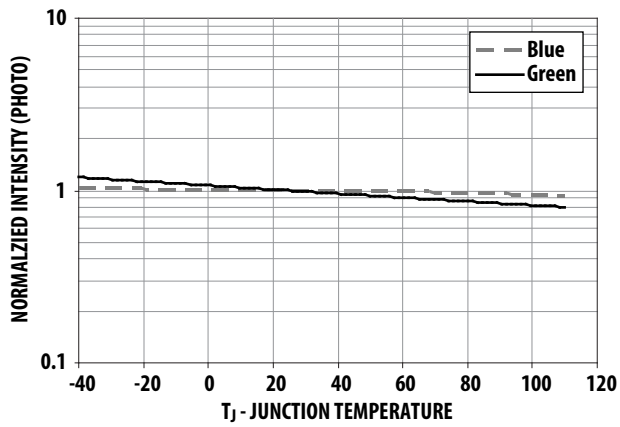

Figure 9. Relative Light Output vs Junction Temperature

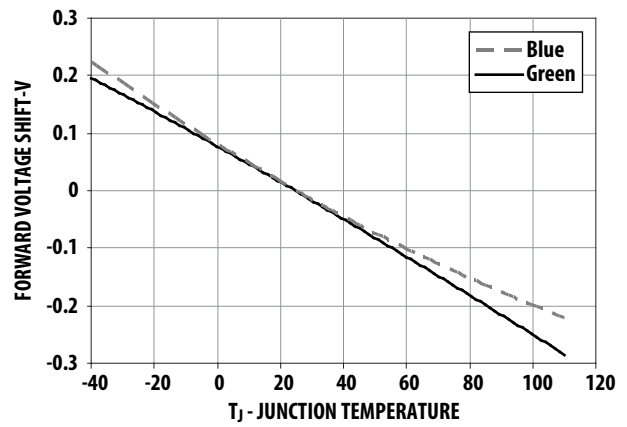

Figure 10. Relative Forward Voltage vs Junction Temperature

### Intensity Bin Limit Table (1.3:1 lv bin ratio)

Bin	Intensity (mcd) at 20mA	
	Min	Max
U	3200	4200
V	4200	5500
W	5500	7200
X	7200	9300
Y	9300	12000
Z	12000	16000
1	16000	21000
2	21000	27000
3	27000	35000
4	35000	45000
5	45000	59000
6	59000	76000

Tolerance for each bin limit is  $\pm 15\%$

### Green Color Bin Table

Bin	Min Dom	Max Dom	Corner Point	Chromaticity Coordinate			
				x	y	z	w
1	519	523	x	0.0667	0.1200	0.1450	0.0979
			y	0.8323	0.7375	0.7319	0.8316
2	523	527	x	0.0979	0.1450	0.1711	0.1305
			y	0.8316	0.7319	0.7218	0.8189
3	527	531	x	0.1305	0.1711	0.1967	0.1625
			y	0.8189	0.7218	0.7077	0.8012
4	531	535	x	0.1625	0.1967	0.2210	0.1929
			y	0.8012	0.7077	0.6920	0.7816
5	535	539	x	0.1929	0.2210	0.2445	0.2233
			y	0.7816	0.6920	0.6747	0.7600

Tolerance for each bin limit is  $\pm 0.5$  nm.

### Blue Color Bin Table

Bin	Min Dom	Max Dom	Corner Point	Chromaticity Coordinate			
				x	y	z	w
1	460	464	x	0.1440	0.1818	0.1766	0.1374
			y	0.0297	0.0904	0.0966	0.0374
2	464	468	x	0.1374	0.1766	0.1699	0.1291
			y	0.0374	0.0966	0.1062	0.0495
3	468	472	x	0.1291	0.1699	0.1616	0.1187
			y	0.0495	0.1062	0.1209	0.0671
4	472	476	x	0.1187	0.1616	0.1517	0.1063
			y	0.0671	0.1209	0.1423	0.0945
5	476	480	x	0.1063	0.1517	0.1397	0.0913
			y	0.0945	0.1423	0.1728	0.1327

Tolerance for each bin limit is  $\pm 0.5$  nm

Note:

1. All bin categories are established for classification of products. Products may not be available in all bin categories. Please contact your Avago representative for further information.



## Precautions:

### Lead Forming:

- The leads of an LED lamp may be preformed or cut to length prior to insertion and soldering on PC board.
- For better control, it is recommended to use proper tool to precisely form and cut the leads to applicable length rather than doing it manually.
- If manual lead cutting is necessary, cut the leads after the soldering process. The solder connection forms a mechanical ground which prevents mechanical stress due to lead cutting from traveling into LED package. This is highly recommended for hand solder operation, as the excess lead length also acts as small heat sink.

### Soldering and Handling:

- Care must be taken during PCB assembly and soldering process to prevent damage to the LED component.
- LED component may be effectively hand soldered to PCB. However, it is only recommended under unavoidable circumstances such as rework. The closest manual soldering distance of the soldering heat source (soldering iron's tip) to the body is 1.59mm. Soldering the LED using soldering iron tip closer than 1.59mm might damage the LED.
- ESD precaution must be properly applied on the

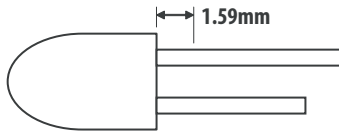

soldering station and personnel to prevent ESD damage to the LED component that is ESD sensitive. Do refer to Avago application note AN 1142 for details. The soldering iron used should have grounded tip to ensure electrostatic charge is properly grounded.

- Recommended soldering condition:

	Wave Soldering [1, 2]	Manual Solder Dipping
Pre-heat temperature	105°C Max.	-
Preheat time	60 sec Max	-
Peak temperature	260°C Max.	260°C Max.
Dwell time	5 sec Max.	5 sec Max

Note:

1. Above conditions refers to measurement with thermocouple mounted at the bottom of PCB.
  2. It is recommended to use only bottom preheaters in order to reduce thermal stress experienced by LED.
- Wave soldering parameters must be set and maintained according to the recommended temperature and dwell time. Customer is advised to perform daily check on the soldering profile to ensure that it is always conforming to recommended soldering conditions.

Note:

1. PCB with different size and design (component density) will have different heat mass (heat capacity). This might cause a change in temperature experienced by the board if same wave soldering setting is used. So, it is recommended to re-calibrate the soldering profile again before loading a new type of PCB.

### Avago Technologies LED Configuration

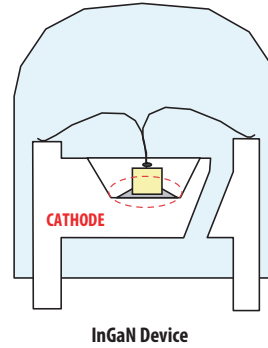

- Any alignment fixture that is being applied during wave soldering should be loosely fitted and should not apply weight or force on LED. Non metal material is recommended as it will absorb less heat during wave soldering process.
- At elevated temperature, LED is more susceptible to mechanical stress. Therefore, PCB must allowed to cool down to room temperature prior to handling, which includes removal of alignment fixture or pallet.
- If PCB board contains both through hole (TH) LED and other surface mount components, it is recommended that surface mount components be soldered on the top side of the PCB. If surface mount need to be on the bottom side, these components should be soldered using reflow soldering prior to insertion the TH LED.
- Recommended PC board plated through holes (PTH) size for LED component leads.

LED component lead size	Diagonal	Plated through hole diameter
0.45 x 0.45 mm (0.018x 0.018 inch)	0.636 mm (0.025 inch)	0.98 to 1.08 mm (0.039 to 0.043 inch)
0.50 x 0.50 mm (0.020x 0.020 inch)	0.707 mm (0.028 inch)	1.05 to 1.15 mm (0.041 to 0.045 inch)

- Over-sizing the PTH can lead to twisted LED after clinching. On the other hand under sizing the PTH can cause difficulty inserting the TH LED.

Refer to application note AN5334 for more information about soldering and handling of high brightness TH LED lamps.

### Example of Wave Soldering Temperature Profile for TH LED

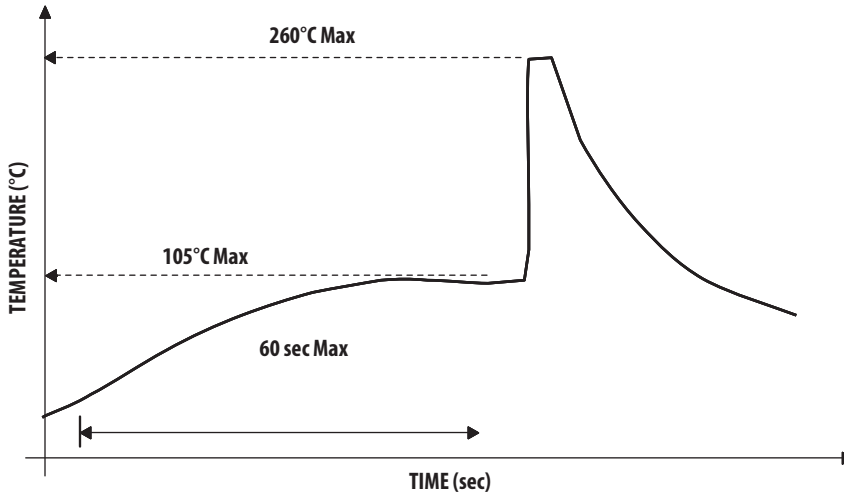

Recommended solder:  
 Sn63 (Leaded solder alloy)  
 SAC305 (Lead free solder alloy)

Flux: Rosin flux

Solder bath temperature:  $255^{\circ}\text{C} \pm 5^{\circ}\text{C}$   
 (maximum peak temperature =  $260^{\circ}\text{C}$ )

Dwell time: 3.0 sec - 5.0 sec  
 (maximum = 5sec)

Note: Allow for board to be sufficiently cooled to room temperature before exerting mechanical force.

### Ammo Packs Drawing

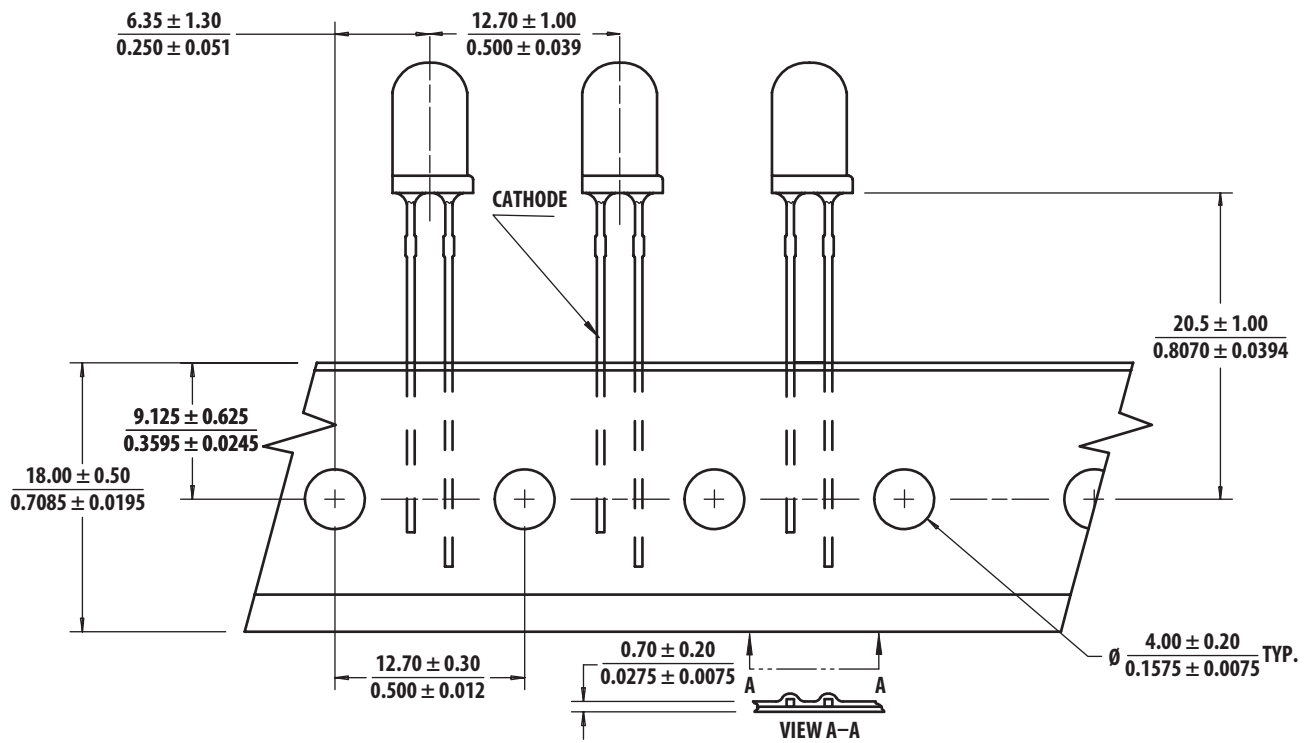

Note: The ammo-packs drawing is applicable for packaging option -DD & -ZZ and regardless standoff or non-standoff

## Packaging Box for Ammo Packs

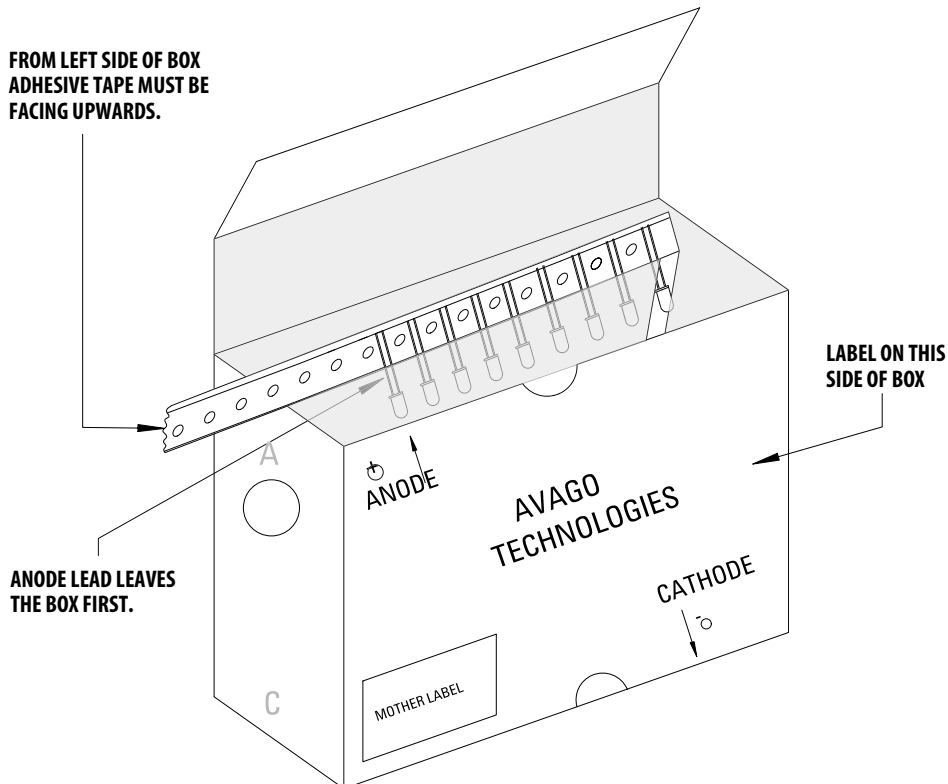







Note: For InGaN device, the ammo pack packaging box contain ESD logo

## Packaging Label

(i) Avago Mother Label: (Available on packaging box of ammo pack and shipping box)

<p>(1P) Item: <b>Part Number</b>  </p>		<p><b>AVAGO</b>          TECHNOLOGIES          STANDARD LABEL LS0002          RoHS Compliant          e3 max temp 260C</p>	
<p>(1T) Lot: <b>Lot Number</b>  </p>		<p>(Q) QTY: <b>Quantity</b>  </p>	
<p>LPN:  </p>		<p>CAT: <b>Intensity Bin</b>  </p>	
<p>(9D)MFG Date: <b>Manufacturing Date</b>  </p>		<p>BIN: <b>Color Bin</b>  </p>	
<hr/>			
<p>(P) Customer Item:  </p>			
<p>(V) Vendor ID:  </p>		<p>(9D) Date Code: <b>Date Code</b>  </p>	
<hr/>			
<p>DeptID:  </p>		<p>Made In: <b>Country of Origin</b>  </p>	

(ii) Avago Baby Label (Only available on bulk packaging)

<b>Avago</b> TECHNOLOGIES		RoHS Compliant e3 max temp 260C	
<b>Lamps Baby Label</b>			
(1P) PART #: Part Number			
(1T) LOT #: Lot Number			
(9D)MFG DATE: Manufacturing Date	QUANTITY: Packing Quantity		
C/O: Country of Origin			
Customer P/N:	CAT: Intensity Bin		
Supplier Code:	BIN: Color Bin		
	DATECODE: Date Code		

**DISCLAIMER:** Avago's products and software are not specifically designed, manufactured or authorized for sale as parts, components or assemblies for the planning, construction, maintenance or direct operation of a nuclear facility or for use in medical devices or applications. Customer is solely responsible, and waives all rights to make claims against avago or its suppliers, for all loss, damage, expense or liability in connection with such use.

For product information and a complete list of distributors, please go to our web site: [www.avagotech.com](http://www.avagotech.com)

Avago, Avago Technologies, and the A logo are trademarks of Avago Technologies in the United States and other countries. Data subject to change. Copyright © 2005-2013 Avago Technologies. All rights reserved.  
AV02-2228EN - May 22, 2013





Компания «ЭлектроПласт» предлагает заключение долгосрочных отношений при поставках импортных электронных компонентов на взаимовыгодных условиях!

Наши преимущества:

- Оперативные поставки широкого спектра электронных компонентов отечественного и импортного производства напрямую от производителей и с крупнейших мировых складов;
- Поставка более 17-ти миллионов наименований электронных компонентов;
- Поставка сложных, дефицитных, либо снятых с производства позиций;
- Оперативные сроки поставки под заказ (от 5 рабочих дней);
- Экспресс доставка в любую точку России;
- Техническая поддержка проекта, помощь в подборе аналогов, поставка прототипов;
- Система менеджмента качества сертифицирована по Международному стандарту ISO 9001;
- Лицензия ФСБ на осуществление работ с использованием сведений, составляющих государственную тайну;
- Поставка специализированных компонентов (Xilinx, Altera, Analog Devices, Intersil, Interpoint, Microsemi, Aeroflex, Peregrine, Syfer, Eurofarad, Texas Instrument, Miteq, Cobham, E2V, MA-COM, Hittite, Mini-Circuits, General Dynamics и др.);

Помимо этого, одним из направлений компании «ЭлектроПласт» является направление «Источники питания». Мы предлагаем Вам помощь Конструкторского отдела:

- Подбор оптимального решения, техническое обоснование при выборе компонента;
- Подбор аналогов;
- Консультации по применению компонента;
- Поставка образцов и прототипов;
- Техническая поддержка проекта;
- Защита от снятия компонента с производства.



#### Как с нами связаться

**Телефон:** 8 (812) 309 58 32 (многоканальный)

**Факс:** 8 (812) 320-02-42

**Электронная почта:** [org@eplast1.ru](mailto:org@eplast1.ru)

**Адрес:** 198099, г. Санкт-Петербург, ул. Калинина, дом 2, корпус 4, литера А.