

Easy-to-use, Space-saving Terminal Relay with Four-point Output

- Almost the same size as PYF Socket: 31 x 35 x 68 mm (W x H x D)
- Each terminal circuit (with coil or contact) is independent from one another.
- Short Bar ensures easy connection of common and adjacent terminals.
- Provided with a terminal cover that prevents electric-shock accidents.
- Relay and MOS FET relay models are available.
- LED operation indicator.
- Built-in diode absorbs coil surge.
- Mounts either on DIN track or screws.
- Tool for easy mounting or removal of Relays provided.
- UL, CSA, and VDE certification for standard models (VDE: G6D-F4B only).

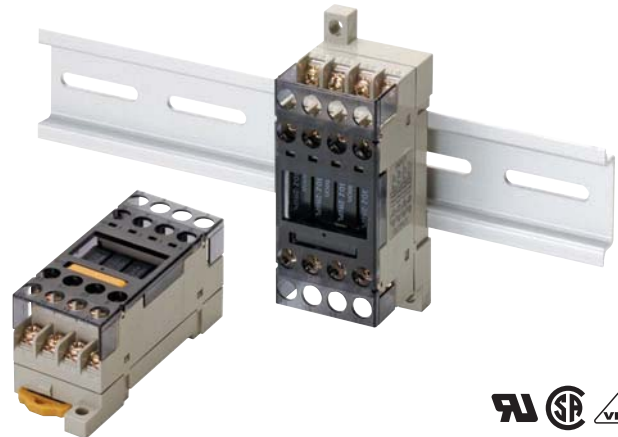

Model Number Structure

Model Number Legend

G6D/G3DZ-

1 2

1. Terminal Form
F: Flat type

2. Number of Relays Mounted
4B: 4

Ordering Information

List of Models

Output	Contact configuration	Model	Rated voltage
Relay output	SPST-NO × 4	G6D-F4B	12 VDC
			24 VDC
Power MOS FET relay output		G3DZ-F4B	12 VDC
			24 VDC

Note: When ordering add the rated coil voltage to the model number.

Example: G6D-F4B 24 VDC

Rated coil voltage

Specifications

■ Ratings

Coil Ratings (per G6D Relay)

Rated voltage	Rated current	Coil resistance	Must operate voltage	Must release voltage	Max. voltage	Power consumption
12 VDC	18.7 mA	720 Ω	70% max. (see note 1)	10% min.	130%	Approx. 200 mW
24 VDC	10.5 mA	2,880 Ω				

- Note:**
1. The must operate voltage is 75% or less of the rated voltage if the Relay is mounted upside down.
 2. Rated current and coil resistance were measured at a coil temperature of 23°C with a tolerance of ±10%.
 3. Operating characteristics were measured at a coil temperature of 23°C.
 4. The maximum allowable voltage is the maximum value of the allowable voltage range for the relay coil operating power supply. There is no continuous allowance.
 5. The rated current includes the terminal's LED current.

Contact Ratings (per G6D Relay)

Item	Resistive load (cosφ = 1)
Rated load	3 A at 250 VAC, 3 A at 30 VDC
Rated carry current	5 A
Max. switching voltage	250 VAC, 30 VDC
Max. switching current	5 A
Max. permissible capacity (reference value)	1,250 VA, 150 W
Error rate (reference value) (see note)	5 VDC, 10 mA

Note: This value is for a switching frequency of 120 times per minute.

■ Power MOS FET Relay Specifications

Input (per G3DZ Power MOS FET Relay)

Rated voltage	Operating voltage	Must operate voltage level	Must release voltage level	Input impedance	Rated current
12 VDC	9.6 to 14.4 VDC	9.6 VDC max.	1 VDC min.	2 kΩ±20%	8.0 mA±20%
24 VDC	19.2 to 28.8 VDC	19.2 VDC max.		4 kΩ±20%	8.2 mA±20%

Note: The rated current includes the terminal's LED current.

Output (per G3DZ Power MOS FET Relay)

Load voltage	Load current	Inrush current
3 to 264 VAC 3 to 125 VDC	100 μ to 0.3 A	6 A (10 ms)

Note: There is no output polarity for the G3DZ.

■ Characteristics

Item	G6D-F4B	
	Relay output	
Contact resistance (see note 2)	100 mΩ max.	
Must operate time (see note 3)	10 ms max.	
Release time (see note 3)	10 ms max.	
Insulation resistance	1,000 MΩ min. (at 500 VDC)	
Dielectric strength	2,000 VAC, 50/60 Hz for 1 min between coil and contacts.	
	1,500 VAC, 50/60 Hz for 1 min between contacts of different polarity	
	750 VAC, 50/60 Hz for 1 min between contacts of same polarity	
Impulse withstand voltage (between coil and contacts)	4,000 V (1.2 × 50 μs)	
Vibration resistance	Destruction: 10 to 55 to 10 Hz, 0.75-mm single amplitude (1.5-mm double amplitude) Malfunction: 10 to 55 to 10 Hz, 0.75-mm single amplitude (1.5-mm double amplitude)	
Shock resistance	Destruction: 500 m/s ² Malfunction: 100 m/s ²	
Endurance	Mechanical: 20,000,000 operations min. (at 18,000 operations/hr)	
	Electrical: 100,000 operations min. (3 A at 250 VAC, resistive load) 100,000 operations min. (3 A at 30 VDC, resistive load) (at 1,800 operations /hr)	
Ambient temperature	Operating: -25°C to 55°C (with no icing)	
Ambient humidity	Operating: 45% to 85%	
Weight	Approx. 65 g	

- Note:** 1. The above values are initial values.
 2. Measurement condition: 1 A at 5 VDC
 3. Ambient temperature condition: 23°C

Item	G3DZ-F4B	
	Power MOS FET relay output	
Must operate time	10 ms max.	
Release time	15 ms max.	
Output ON-resistance	2.4 Ω max.	
Leakage current at OFF state	10 μA max. (at 125 VDC)	
Insulation resistance	100 MΩ min. (at 500 VDC)	
Dielectric strength	2,000 VAC, 50/60 Hz for 1 min between input and output terminals	
	1,500 VAC, 50/60 Hz for 1 min between contacts of different polarity	
Vibration resistance	Destruction: 10 to 55 to 10 Hz, 0.75-mm single amplitude (1.5-mm double amplitude)	
Shock resistance	Destruction: 500 m/s ²	
Ambient temperature	Operating: -25°C to 55°C (with no icing)	
Ambient humidity	Operating: 45% to 85%	
Weight	Approx. 65 g	

Engineering Data

Maximum Switching Power

G6D-F4B

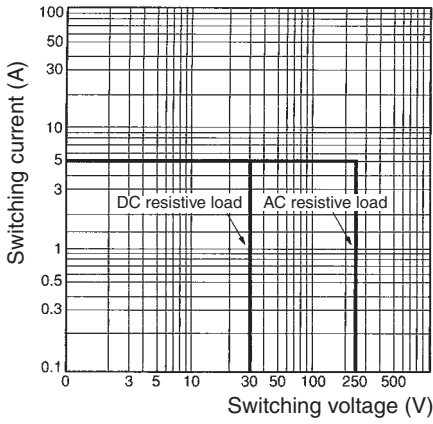

Endurance

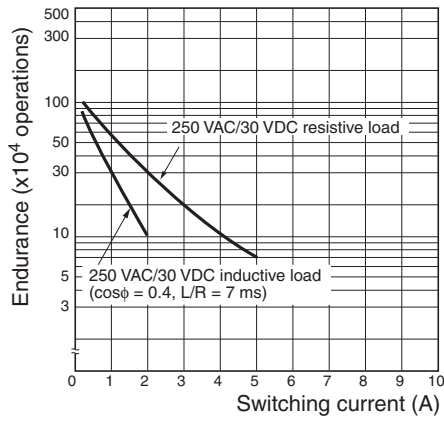

Load Current vs. Ambient Temperature

G3DZ-F4B

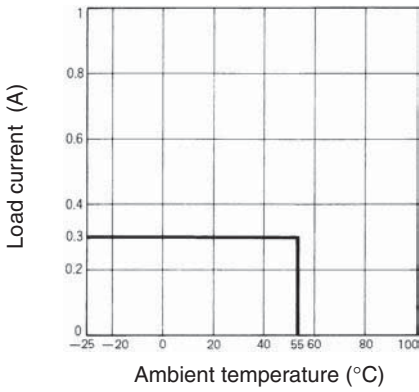

Inrush Current Resistivity: Non-repetitive

Keep the inrush current to half the rated value if it occurs repetitively.

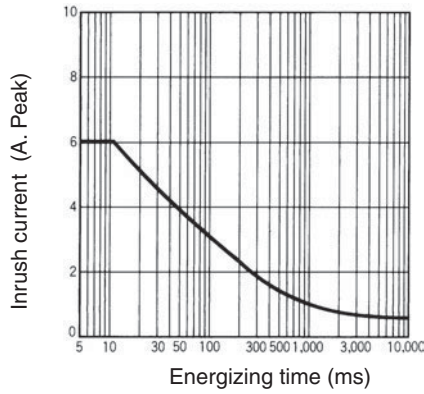

Dimensions

Note: All units are in millimeters unless otherwise indicated.

G6D-F4B G3DZ-F4B

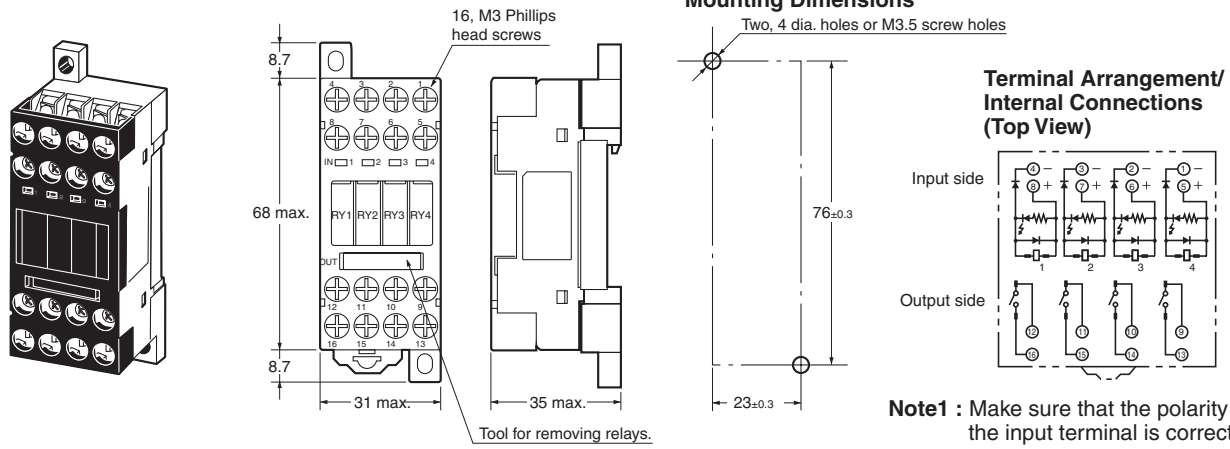

Note1 : Make sure that the polarity of the input terminal is correct.

Note2 : There is no output polarity for the G6D-F4B and G3DZ-F4B.

■ Accessories (Order Separately)

G6D-4-SB Short Bar

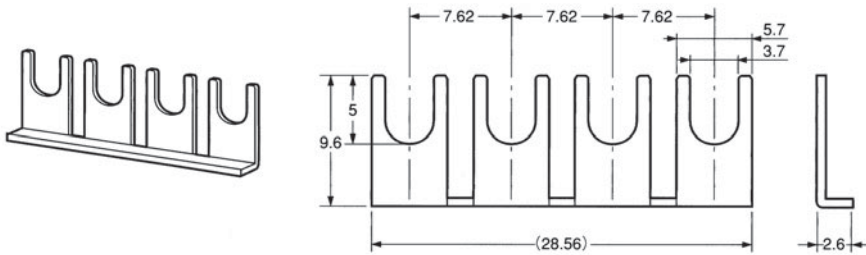

Applicable model	Model
G6D-F4B	G6D-4-SB
G3DZ-F4B	

Relay Mounting Products

Name	Model
Mounting track	PFP-100N
	PFP-50N
	PFP-100N2
End plate	PFP-M
Spacer	PFP-S

Short Bar

Applicable Terminal Relay	Model
G6D-F4B	G6D-4-SB
G3DZ-F4B	

Replacement Relays

Applicable Terminal Relay	Model	Rated voltage
G6D-F4B	G6D-1A-ASI	12 VDC
		24 VDC
G3DZ-F4B	G3DZ-2R6PL	12 VDC
		24 VDC

Note: Error rate (P level) for the G6D-1A-ASI is 5 V at 10 mA and that for the G6D-1A-AP is 5 V at 1 mA.

Safety Precautions

Refer to *Safety Precautions for All Relays*.

Wiring

Be sure to turn OFF the power when wiring the Unit and do not touch the charged terminals of the Unit. Otherwise, an electric shock may result.

Do not apply overvoltage to the input terminals. Otherwise, the Unit may malfunction or burn.

Relay Models

Do not connect the Unit to loads exceeding the rated switching power (switching voltage or current). Otherwise, faulty insulation, contact weld, or faulty contact of Relays, or damage to Relays may result, or the Relays may malfunction or burn.

The life of Relays varies with the switching condition. Test the Relays under the actual operating conditions before using the Relays within the permissible switching frequency. The use of deteriorated Relays may result in the faulty insulation of the Relays or cause the Relays to burn.

Do not use the Unit in locations with inflammable gas. Otherwise, a fire or explosion due to the heat of the Relays or sparks from the Relays may result when they are switched.

SSR Output (Power MOS FET Relay Model)

Do not connect the Unit to loads consuming a total current exceeding the rated output current of the Unit. Otherwise, the output element of the Unit may be damaged and a short or open-circuit malfunction may result.

If the Unit is connected to a DC inductive load, connect a diode to the Unit to protect the Unit from counter-electromotive voltage, otherwise the counter-electromotive voltage may damage the output element and a short or open-circuit malfunction may result.

■ Correct Use

Mounting

When mounting two or more Units, reduce the current and ON duty and provide an appropriate distance between the Units so that the ambient temperature will not exceed 55°C.

Relay Replacement

Use the Relay Removal Tool provided with the Unit to dismount a Relay.

Be sure to turn OFF the power to the Unit before replacing a Relay.

When mounting a Relay, insert the Relay vertically so that the relay terminals will come in contact with the socket contact pins properly.

Do not mount Relays that are different to one another in voltage.

Wiring

Pay utmost attention not to make mistakes with the polarity of the input terminals.

Coil Voltage

Make sure not to impose voltage exceeding the permissible voltage on the coil continuously.

Do not connect any inductive load in parallel to the coil input as shown in the following example or power supply with a surge voltage. Otherwise, the surge absorption diode will be damaged.

Do Not Use the Following Circuit

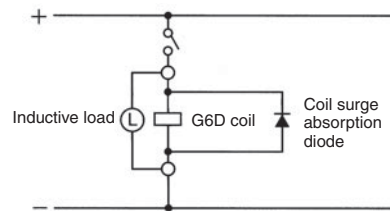

Handling

Do not drop, shock, or vibrate the Unit excessively. Otherwise, damage to the Unit may result or the Unit may malfunction.

Make sure that all the Relays are properly mounted before use.

Screw Tightening Torque

Tighten each terminal screw to a torque of 0.78 to 1.18N·m.

Tighten each mounting screw to a torque of 0.59 to 0.98 N·m.

Installation Environment

Do not install the Unit in the following locations. Otherwise, damage to the Unit may result or the Unit may malfunction.

Locations with direct sunlight.

Locations with an ambient temperature range not within -25°C to 55°C.

Locations with rapid temperature changes resulting in condensation or locations with relative humidity ranges not within 45% to 85%.

Locations with corrosive or inflammable gas.

Locations with excessive dust, salinity, or metal powder.

Locations with vibration or shock affecting the Unit.

Locations with water, oil, or chemical sprayed on the Unit.

Disassembly, Repair, and Modification

Do not disassemble, repair, or modify the Unit. Otherwise, an electric shock may result or the Unit may malfunction.

Mounted Relays

Relays and SSRs cannot be mounted together.

ALL DIMENSIONS SHOWN ARE IN MILLIMETERS.

To convert millimeters into inches, multiply by 0.03937. To convert grams into ounces, multiply by 0.03527.

In the interest of product improvement, specifications are subject to change without notice.



Компания «ЭлектроПласт» предлагает заключение долгосрочных отношений при поставках импортных электронных компонентов на взаимовыгодных условиях!

Наши преимущества:

- Оперативные поставки широкого спектра электронных компонентов отечественного и импортного производства напрямую от производителей и с крупнейших мировых складов;
- Поставка более 17-ти миллионов наименований электронных компонентов;
- Поставка сложных, дефицитных, либо снятых с производства позиций;
- Оперативные сроки поставки под заказ (от 5 рабочих дней);
- Экспресс доставка в любую точку России;
- Техническая поддержка проекта, помощь в подборе аналогов, поставка прототипов;
- Система менеджмента качества сертифицирована по Международному стандарту ISO 9001;
- Лицензия ФСБ на осуществление работ с использованием сведений, составляющих государственную тайну;
- Поставка специализированных компонентов (Xilinx, Altera, Analog Devices, Intersil, Interpoint, Microsemi, Aeroflex, Peregrine, Syfer, Eurofarad, Texas Instrument, Miteq, Cobham, E2V, MA-COM, Hittite, Mini-Circuits, General Dynamics и др.);

Помимо этого, одним из направлений компании «ЭлектроПласт» является направление «Источники питания». Мы предлагаем Вам помощь Конструкторского отдела:

- Подбор оптимального решения, техническое обоснование при выборе компонента;
- Подбор аналогов;
- Консультации по применению компонента;
- Поставка образцов и прототипов;
- Техническая поддержка проекта;
- Защита от снятия компонента с производства.



Как с нами связаться

Телефон: 8 (812) 309 58 32 (многоканальный)

Факс: 8 (812) 320-02-42

Электронная почта: org@eplast1.ru

Адрес: 198099, г. Санкт-Петербург, ул. Калинина, дом 2, корпус 4, литера А.