

Powerpole® Connectors - PP75: up to 120 Amps

PP75 with
Mounting Wings

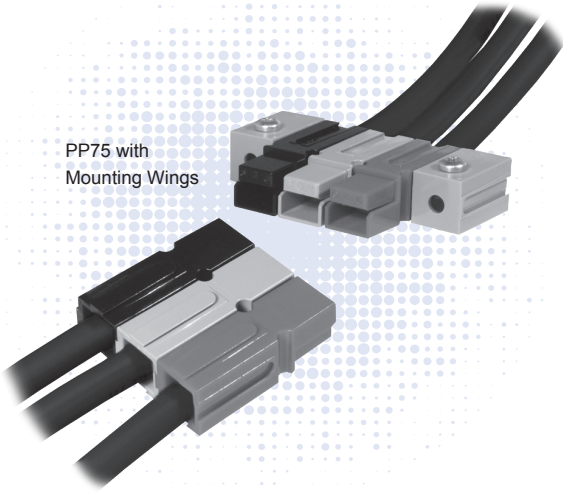

SECTION 2
Powerpole® PP75

PP75 series Powerpole® housings can be used for wire-to-wire, wire-to-board, and wire-to-busbar applications. Wire sizes from #16 AWG (1.3 mm²) to #6 (13.3 mm²) offer power capabilities up to 120 amps per pole. Locking housings offer the capability to secure Powerpole® housings to each other and to mounting pads. Housings made from chemical resistant (CR) resin withstand industrial solvents better than standard housings.

- **Large Wire Range Accommodates up to #6 (10mm²) Wire**
Reducing bushings allow as small as #16 (1.5 mm²) wire to be used
- **Wire, PCB, and Busbar Contacts**
Allows one connection system to meet multiple needs
- **Mini-Powerclaw PCB Contacts Minimize PCB Footprint**
Removes the PP75 housing from the board side

| PP75 ORDERING INFORMATION |

PP75 Standard Housings

The second smallest Powerpole® housing can be used with wire contacts for up to 6 AWG [10mm²] as well as PCB and busbar contacts.

| Description | ----- Part Numbers ----- | |
|----------------------|--------------------------|-----------|
| Minimum Quantity ... | 1,000 | 100 |
| Red | 5916G7-BK | 5916G7 |
| Green | 5916G6-BK | 5916G6 |
| Black | 5916G4-BK | 5916G4 |
| White | 5916G5-BK | 5916G5 |
| Blue | 5916-BK | 5916 |
| Yellow | 5916G15-BK | 5916G15 |
| Orange | 5916G14-BK | 5916G14 |
| Gray | 5916G16-BK | 5916G16 |

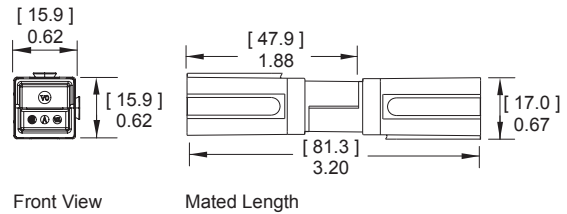

PP75 Chemical Resistant (CR) Housings

Has the same form and dimensions of the standard PP75 housing in a chemical resistant PBT/ PC blend housing. Suitable for use to -40°C.

| Description | - Part Numbers - |
|----------------------|------------------|
| Minimum Quantity ... | 1,000 |
| Red | P5916G7-BK |
| Black | P5916G4-BK |
| White | P5916G5-BK |
| Blue | P5916-BK |

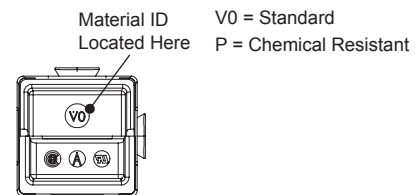

PP75 Locking Dovetail Housings

Offers dovetails for stacking housings that have a locking feature to prevent housings separating. Can mate to standard and chemical resistant housings, but cannot be stacked with them.

| Description | Part Numbers | |
|-----------------------|--------------|-----------|
| Minimum Quantity | 1,000 | 100 |
| Red | 75LOKRED-BK | 75LOKRED |
| Green | 75LOKGRN-BK | 75LOKGRN |
| Black | 75LOKBLK-BK | 75LOKBLK |
| White | 75LOKWHT-BK | 75LOKWHT |
| Blue | 75LOKBLU-BK | 75LOKBLU |
| Gray | 75LOKGRA-BK | 75LOKGRA |



PP75 Silver Plated Wire Contacts

Silver plated contacts offer the best electrical performance and durability up to 10,000 mating cycles. See reducing bushings in accessory section for smaller wires.

| AWG | mm ² | Mating Force | Loose Piece | | Dimensions - A - | |
|------------------------|-----------------|--------------|--------------------|------|------------------|------|
| | | | -- Part Numbers -- | | inches | mm |
| Minimum Quantity | | | 1,000 | 100 | | |
| 6 | 13.3 | Low | 1307-BK | 1307 | 0.22 | 5.59 |
| 6 | 13.3 | High | 5900-BK | 5900 | 0.22 | 5.59 |
| 8 | 8.4 | High | 5952-BK | 5952 | 0.19 | 4.83 |
| 12 to 10 | 3.3 to 5.3 | Low | 5953-BK | 5953 | 0.14 | 3.56 |
| 12 to 10 | 3.3 to 5.3 | High | 5915-BK | 5915 | 0.14 | 3.56 |



PP75 Silver Plated Busbar Contacts

Provide a quick disconnect input or output busbar connection. Busbar contacts are for mating with wire contacts only. Part number 75BBS includes lock nuts. Locknuts must be ordered separately for B01956P4.

| Type | Thread | Mating Force | Part Numbers | | |
|------------------------|--------|--------------|--------------|--------|--------|
| | | | | | |
| Minimum Quantity | | | 1,000 | 20 | 10 ... |
| Busbar | #10-24 | High | B01915P1 | - | 75BBS |
| Lock Nut | #10-24 | - | H1216P8 | 110G54 | - |

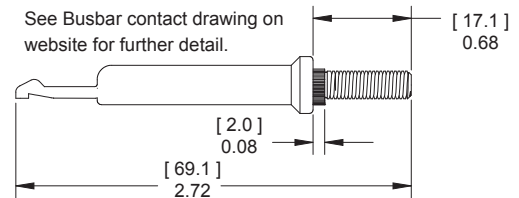

55A Right Angle Standard Powerclaw PCB Contacts

Standard Powerclaw contacts are for use inside a PP75 housing and provide a color coded right angle connection to the PCB.

| Description | --- Loose Piece Part Numbers --- | |
|------------------------|----------------------------------|-----------|
| Minimum Quantity | 500 | 100 |
| Tin Plated | PC5930T-BK | PC5930T |
| Silver Plated | PC5930S-BK | PC5930S |

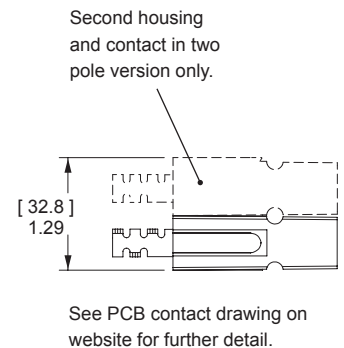
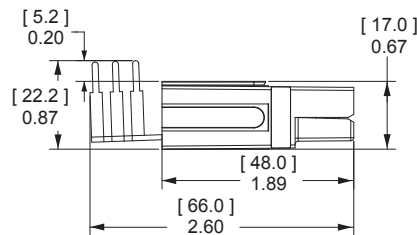
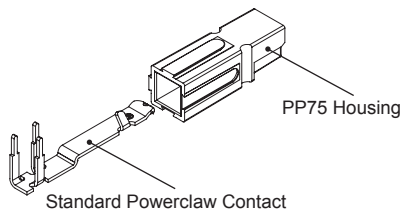

55A Right Angle Mini Powerclaw PCB Contacts

Right angle Mini Powerclaw contacts can be used on the PCB edge without a PP75 housing on the PCB side. A self polarizing design only allow PP75 wire housings to mate to PCB contacts one way.

| Description | Loose Piece | |
|----------------------|--------------------------|-----------|
| | ----- Part Numbers ----- | |
| Minimum Quantity ... | 1,000 | 100 |
| Tin Plated | PC5934T-BK | PC5934T |
| Silver Plated | PC5934S-BK | PC5934S |



55A Vertical Mini Powerclaw PCB Contacts

Vertical Mini Powerclaw contacts save space by not requiring a PP75 housing on the PCB side. The guide housing is required for 2 pole applications to provide a polarized connection. (See PP75 accessories).

| Description | Loose Piece | |
|----------------------|--------------------------|-----------|
| | ----- Part Numbers ----- | |
| Minimum Quantity ... | 1,500 | 100 |
| Tin Plated | PC5933T-BK | PC5933T |
| Silver Plated | PC5933S-BK | PC5933S |



See PCB contact drawing on website for further detail.

PP75 TEMPERATURE CHARTS

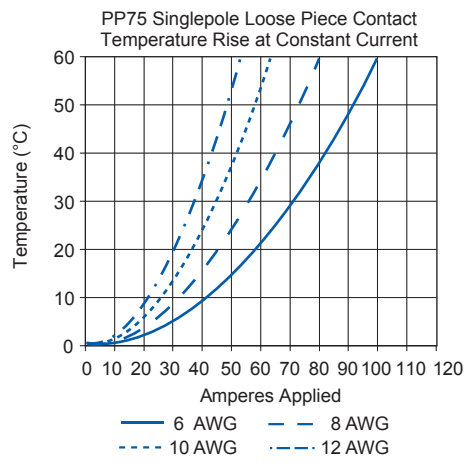

NOTE: Temperature rise charts are based on a 25°C ambient temperature. Powerclaw charts are based on #8 AWG equivalent copper foil on board side, mated to #6 AWG conductor on wire side.

PP75 SPECIFICATIONS |

| Electrical | | |
|---|----------------|------------|
| Current Rating Amperes¹ | UL 1977 | CSA |
| Wire to Wire (6 AWG) | 120 | 70 |
| Wire to PCB (6-AWG) | 55 | 50 |
| Wire to Busbar (6 AWG) | 75 | |
| Voltage Rating AC/DC | | |
| UL 1977 | 600 | |
| PCB Connector Recommended Voltage³ | | |
| per IEC 60950-1 Table 2L Pollution Degree² | | |
| Mini Vert. Contact Adjacent Poles | 220 | |
| Mini Horiz. Contact Adjacent Poles | 200 | |
| Standard Contact Adjacent Poles | 635 | |
| Dielectric Withstanding Voltage | | |
| Volts AC | 2,200 | |
| Avg. Mated Contact Resistance Milliohms¹ | | |
| Wire Contact with 1 1/4" of #6 AWG | 0.200 | |
| PCB Contact to Contact | 0.500 | |
| UL Hot Plug Current Rating Amperes - 250 cycles at 120V DC | | |
| Wire- wire | 50A | |
| PCB- wire (Vertical Mini Powerclaw) | 40A | |

| Materials | |
|------------------------------------|---------------------------|
| Housing | |
| Standard Plastic Resin | Polycarbonate |
| Chem. Resistant Resin | Polycarbonate / PBT blend |
| Contact Retention Spring | Stainless Steel |
| Housing Flammability Rating | |
| UL94 | V-0 |
| Contact | |
| Base | Copper Alloy |
| Wire Plating | Silver |
| PCB Plating | Sn or Ag over Ni |
| Contact Termination Methods | |
| Crimp ⁴ | Wire Contacts |
| Hand Solder | Wire and PCB Contacts |
| Solder Dip [*] | PCB Contacts |
| Wave Solder [*] | PCB Contacts |
| Wrench / Socket | Busbar Contacts |

| Mechanical | | |
|---|------------------------|-----------------------|
| Wire Size Range | AWG | mm² |
| Wire Conctcs with Bushings | 16 to 6 | 1.3 to 13.3 |
| Max. Wire Insulation Diameter | in. | mm |
| | 0.437 | 11.100 |
| Operating Temperature² | °F | °C |
| Standard | -4° to 221° | -20° to 105° |
| Chemical Resistant [*] | -40 to 221° | -40° to 105° |
| *Chemical resistant material not available for PCB guide housings | | |
| Mating Cycles No Load by Plating | Silver (Ag) | Tin (Sn) |
| Wire and PCB Contacts | 10,000 | 1,500 |
| Avg. Mating / Unmating Force | Lbf. | N |
| Wire to Wire Low Force Contacts | 5 | 22 |
| Wire to Wire High Force Contacts | 7 | 31 |
| Standard Powerclaw to Wire | 7 | 31 |
| Mini Powerclaw to Wire | 4 | 17 |
| PCB Specifications | | |
| Mounting Style | Plated Through Hole | |
| Max PCB Thickness- in. [mm] | Standard: 0.15 [0.381] | |
| | Mini: 0.25 [0.635] | |
| Recommended Traces | #8 AWG Cross Section | |
| Min. Contact / Spring Retention Force | Lbf. | N |
| Wire Housing | 50 | 222 |
| Min. Creepage / Clearance Distance PCB in. | | mm |
| Standard Powerclaw Adjacent Poles | 0.260 | 6.6 |
| Mini Vert. Powerclaw Adjacent Poles | 0.087 | 2.2 |
| Mini Horiz. Powerclaw Adjacent Poles | 0.079 | 2.0 |

| Protection | |
|--|------|
| Touch Safety with Wire Contacts | |
| IEC 60529 | IP10 |

¹ Based on: 105°C rated or better cable of the largest size, Properly calibrated APP® recommended tooling, and a 25°C ambient temperature. UL rating not to exceed the maximum operating temperature. CSA rating below a 30°C temperature rise.

² Limited by the thermal properties of the connector plastic housing.

³ Without use of spacers to increase creepage and clearance distances.

⁴ Use APP® recommended tooling only. Alternate tools may adversely affect the performance of our connectors along with UL and CSA recognition.



| Powerpole® PP75 Accessories |

Strain Relief Grommets

Use for strain relief in the back side of a PP75 housing. Wire gauge given for reference only, use grommet ID and wire OD to determine suitability in the end application.

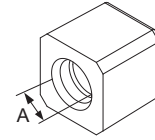

| Description | - Part Numbers - | Dimensions | |
|----------------------|------------------|------------|-----------|
| | | - A - | inches mm |
| Minimum Quantity ... | 100 | | |
| #6 AWG, Black | 114411P2 | 0.35 | 8.89 |
| #8 AWG, Black | 114411P1 | 0.25 | 6.35 |
| #10 - 12 AWG, Black | 114411P3 | 0.17 | 4.32 |

Mounting Wing for Standard or CR Housings

Mounting wings can be used to secure dovetailed Powerpole® 75 series housings by passing fasteners through the wings in either a horizontal or vertical orientation. Useful for sheet metal panels, printed circuit boards, and many other mounting surfaces. Fasteners not included.

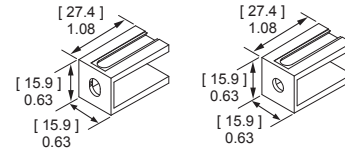

| Description | ----- Part Numbers ----- | |
|----------------------|--------------------------|---------|
| Minimum Quantity ... | 1,000 | 100 ... |
| Blue, Round Hole | 1399G20-BK | 1399G20 |
| Blue, Oval Hole | 1399G7-BK | 1399G7 |

Mounting Wing for Locking Housings

Mounting wings can be used to secure Powerpole® 75 series housings with locking dovetails by passing fasteners through the wings in either a horizontal or vertical orientation. Useful for sheet metal panels, printed circuit boards, and many other mounting surfaces. Fasteners not included.

| Description | ----- Part Numbers ----- | |
|----------------------|--------------------------|---------------|
| Minimum Quantity ... | 1,000 | 100 ... |
| Blue, Oval Hole | 75LOKWNGBLU-BK | 75LOKWNGBLU |
| Blue, Round Hole | 75LOKWNGBLU-R-BK | 75LOKWNGBLU-R |

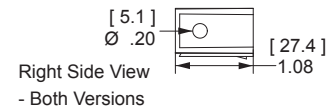
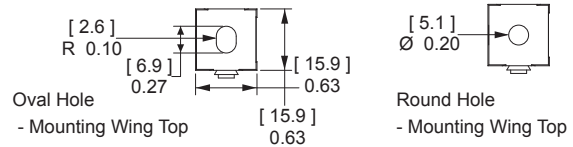

Surface Mount for Locking Housings

Use to secure Powerpole® 75 series housings with locking dovetails to a flat surface. Useful for sheet metal panels, printed circuit boards, and many other mounting surfaces. Fasteners not included.

| Description | ----- Part Numbers ----- | |
|----------------------|--------------------------|-------------|
| Minimum Quantity ... | 1,000 | 100 ... |
| Blue | 75LOKSMTBLU-BK | 75LOKSMTBLU |

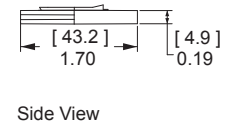
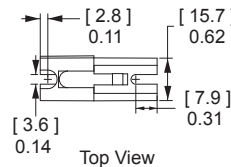

NEW Spacer

Use to separate housings under high power to minimize power capability derating due to heat rise. They are recommended for squaring off a block of Powerpole® 75 housings to enable mounting accessories or retaining pins to be used. Combining long and short spacers opposite each other in a mated block adds keying features, or use two short spacers to avoid interference.

| Description | ----- Part Numbers ----- | |
|---------------------|--------------------------|---------|
| Minimum Quantity... | 1000 | 100 ... |
| Red, Short | Available Soon | |
| Red, Long | Available Soon | |

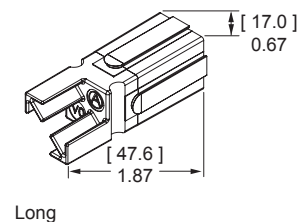
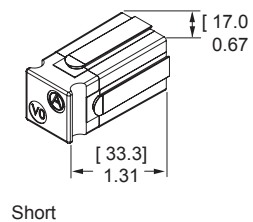

Guide Housings for Vertical Mini Powerclaw Contacts

Prevents polarity being reversed when a two pole PP75 block is mated to vertical mini Powerclaw contacts. Fastening hardware not included.

| Description | Part Numbers | |
|----------------------|--------------|-----------|
| Minimum Quantity ... | 1,000 | 100 ... |
| Black Guide Housing | PC-HSG-PP-BK | PC-HSG-PP |



Mounting Clamp

Mounting clamps can be used for fastening a block of Powerpole® 75 series housings to a panel. Connector blocks must be a complete square for the clamps to work properly. Fastening hardware not included.

| Description | Part Numbers | |
|----------------------|------------------|--|
| Minimum Quantity ... | 50 sets of 2 ... | |
| 2 or 4 Pole | 1463G1 | |
| 3 or 6 Pole | 1463G2 | |



Retaining Pins

Retaining pins are used to keep stacked Powerpole® 75 series housings from separating. Retaining pins are inserted in the circular opening between two housings stacked side by side. Dimension B is +/- 0.015 in or 0.38 mm.

| Description | Part Numbers | | Dimensions | | | |
|----------------------|--------------|--------|---------------|-------------|-------|--------|
| | | | - A - | | - B - | |
| | inches | mm | inches | mm | | |
| Minimum Quantity ... | 1,000 | 100 | | | | |
| 1 Block High | 111812P7 | 110G19 | 0.196 / 0.207 | 4.98 / 5.26 | 0.560 | 14.220 |
| 2 Block High | 111812P6 | 110G18 | 0.196 / 0.207 | 4.98 / 5.26 | 1.000 | 25.400 |



PCB Mounting Staples

Reduce strain on solder joints during mating and unmating. Staples bend over the underside of the PCB board to lock the housings in place. Staples are an interference fit with housings.

| Part Numbers | Number of Stacked Powerpoles® | H x W |
|----------------------|-------------------------------|-------|
| Minimum Quantity ... | 100 | |
| PCSTAPLE-1 | 1 x 1 | |
| PCSTAPLE-2 | 1 x 2 | |

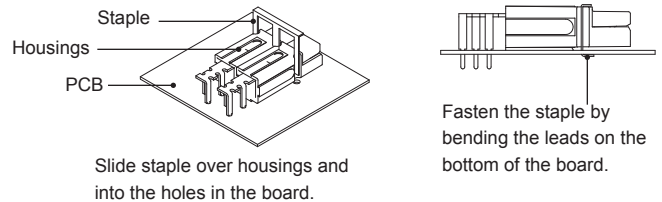

Reducing Bushings

Use with contact part number 5900-BK or 1307-BK to allow a smaller wire to be used with the connector. Electrical capability is derated with smaller wire.

| Contact Barrel Size | Wire Size | Part Numbers | | | Dimensions | | | |
|----------------------|----------------------------|--------------|---------|--------|------------|--------|------|-------|
| | | inches | mm | inches | mm | inches | mm | |
| Minimum Quantity ... | | 3,000 | 1,000 | 100 | | | | |
| #6 AWG [13.3 mm²] | #8 AWG [8.4 mm²] | - | 5912-BK | 5912 | 0.18 | 4.57 | 0.45 | 11.43 |
| #6 AWG [13.3 mm²] | #12- 10 AWG [3.3- 5.3 mm²] | 5910-BK | - | 5910 | 0.14 | 3.56 | 0.47 | 11.94 |
| #6 AWG [13.3 mm²] | #16- 14 AWG [1.3- 2.1 mm²] | 5913-BK | - | 5913 | 0.09 | 2.29 | 0.47 | 11.94 |

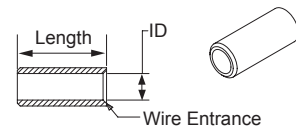

For environmentally sealed connector shells to hold Powerpole® 15-180 connectors, see APP®'s SPEC Pak® product series on our website, www.andersonpower.com



Powerpole® - Tooling Information

| Wire Size | | Loose Piece Part Numbers | | Loose Piece Contact Crimp Tool | | | | | Reeled Part Numbers | | Reeled Contact Crimp Tools | | | |
|---|------------|--------------------------|----------------|--------------------------------|------------------------|---------|-----------|------------------|---------------------|----------------|----------------------------|------------|--------------------------------|-------------------------------|
| AWG | mm² | Tin Plating | Silver Plating | Hand Tool or | Pneumatic Bench Tool | + Die | + Locator | Number of Crimps | Tin Plating | Silver Plating | ATS Applicator | ATS Press | Air Feed Kit* | |
| PP15 / 45 Flat Wiping Power & Ground | | | | | | | | | | | | | | |
| 16 / 20 | 1.3 / 0.52 | N/A | 1332 | 1309G2 or 1309G8 | 1367G1 | | | | N/A | N/A | N/A | N/A | N/A | |
| 12 / 16 | 3.3 / 1.3 | N/A | 1331 | | 1309G3 or 1309G8 | N/A | N/A | N/A | Single | 262G1 | 262G2 | 1385519-1 | 1725900-2 or [3-54500-1] | 1424266-1 or [354578-1] |
| 16 / 20 | 1.3 / 0.52 | 262G1-LPBK | 262G2-LPBK | 200G2L | | | | | | 200G4L | TBD | | | |
| 16 / 20 | 1.5 / 0.52 | 200G2L-LPBK | 200G4L-LPBK | 269G2 | | | | | | N/A | 1385519-1 | | | |
| 16 / 20 | 1.3 / 0.52 | 269G2-LPBK | N/A | 261G1 | | | | | | 261G4 | 1385520-1 | | | |
| 12 / 16 | 3.3 / 1.3 | 261G1-LPBK | 261G4-LPBK | 261G2 | | | | | | 261G3 | 1385458-1 | | | |
| 10 / 14 | 5.3 / 2.1 | 261G2-LPBK | 261G3-LPBK | 269G1 | | | | | | N/A | 1385520-1 | | | |
| 12 / 16 | 3.3 / 1.3 | 269G1-LPBK | N/A | 269G3 | | | | | | N/A | 1385458-1 | | | |
| 10 / 14 | 5.3 / 2.1 | 269G3-LPBK | N/A | 200G1L | | | | | | 200G3L | 1385460-1 | | | |
| 10 / 14 | 6.0 / 2.1 | 200G1L-LPBK | 200G3L-LPBK | 201G1H | | | | | | 201G3H | 1385460-1 | | | |
| 10 / 14 | 6.0 / 2.1 | 201G1H-LPBK | 201G3H-LPBK | 1830G1 | | | | | | 1830G2 | 1385460-1 | | | |
| 10 / 14 | 6.0 / 2.1 | 1830G1-LPBK | 1830G2-LPBK | | | | | | | | | | | |
| PP75 | | | | | | | | | | | | | | |
| #6 | 13.3 | N/A | 1307 | 1309G4 | 1387G1 | 1388G6 | 1389G6 | Single | 265G5 | N/A | 1385523-1 | 2-565435-2 | 692655-1 | |
| | | | 5900 | | | | | | | | | | | |
| #8 | 8.4 | | 5952 | | | | | | | | | | | |
| #10 / 12 | 5.3 / 3.3 | | 5953 | | | | | | | | | | | |
| | | | 5915 | | | | | | | | | | | |
| PP120 | | | | | | | | | | | | | | |
| 1/0 | 53.5 | N/A | 1323G2 | 1368 | 1387G1 | 1388G3 | 1389G4 | Single | N/A | N/A | N/A | N/A | N/A | |
| #1 | 42.4 | | 1323G1 | | | | | | | | | | | |
| #2 | 33.6 | | 1319 | | | | | | | | | | | |
| #4 | 21.2 | | 1319G4 | | | | | | | | | | | |
| #6 | 13.3 | | 1319G6 | | | | | | | | | | | |
| PP180 | | | | | | | | | | | | | | |
| 3/0 | 85 | N/A | 1328G2 | 1368 | 1387G1 | 1303G12 | 1304G32 | Double | N/A | N/A | N/A | N/A | N/A | |
| 2/0 | 53.5 | | 1328G1 | | | 1387G2 | | | | | | | | |
| 1/0 | 53.5 | | 1382 | | | 1303G13 | | | | | | | | |
| #1 | 42.4 | | 1347 | | | 1388G3 | 1389G3 | Single | | | | | | |
| #2 | 33.6 | | 1383 | | | 1387G2 | 1303G13 | 1304G32 | | | | | | Double |
| | | | | | | 1387G1 | 1388G3 | 1389G3 | | | | | | Single |
| #4 | 21.1 | | 1384 | | | 1387G2 | 1303G13 | 1304G32 | | | | | | Double |
| | | | | | | 1387G1 | 1388G4 | 1389G3 | | | | | | Single |
| #6 | 13.3 | | 1348 | | | | | | | | | | | |

* All ATS applicators for APP® contacts are air feed style, (except 1385870) and require the press to have an air feed kit installed.
NOTE: See website for the most current information.

Mouser Electronics

Authorized Distributor

Click to View Pricing, Inventory, Delivery & Lifecycle Information:

[Anderson Power Products:](#)

[PC5930S-BK](#) [PC5934S-BK](#) [PC5930T-BK](#) [PC5933S-BK](#)



Компания «ЭлектроПласт» предлагает заключение долгосрочных отношений при поставках импортных электронных компонентов на взаимовыгодных условиях!

Наши преимущества:

- Оперативные поставки широкого спектра электронных компонентов отечественного и импортного производства напрямую от производителей и с крупнейших мировых складов;
- Поставка более 17-ти миллионов наименований электронных компонентов;
- Поставка сложных, дефицитных, либо снятых с производства позиций;
- Оперативные сроки поставки под заказ (от 5 рабочих дней);
- Экспресс доставка в любую точку России;
- Техническая поддержка проекта, помощь в подборе аналогов, поставка прототипов;
- Система менеджмента качества сертифицирована по Международному стандарту ISO 9001;
- Лицензия ФСБ на осуществление работ с использованием сведений, составляющих государственную тайну;
- Поставка специализированных компонентов (Xilinx, Altera, Analog Devices, Intersil, Interpoint, Microsemi, Aeroflex, Peregrine, Syfer, Eurofarad, Texas Instrument, Miteq, Cobham, E2V, MA-COM, Hittite, Mini-Circuits, General Dynamics и др.);

Помимо этого, одним из направлений компании «ЭлектроПласт» является направление «Источники питания». Мы предлагаем Вам помощь Конструкторского отдела:

- Подбор оптимального решения, техническое обоснование при выборе компонента;
- Подбор аналогов;
- Консультации по применению компонента;
- Поставка образцов и прототипов;
- Техническая поддержка проекта;
- Защита от снятия компонента с производства.



Как с нами связаться

Телефон: 8 (812) 309 58 32 (многоканальный)

Факс: 8 (812) 320-02-42

Электронная почта: org@eplast1.ru

Адрес: 198099, г. Санкт-Петербург, ул. Калинина, дом 2, корпус 4, литера А.