

Product P/N	Flex Cable P/N In Wistron	DIM"A"	DIM"B"	DIM"C"	DIM"D"	DIM"E"	BGA Array Pattern
10127624-13608XXLF	13608	16.55	14.80	12.82	22.30	93.09	6X14
10127624-13609XXLF	13609	19.40	17.65	11.36	25.15	97.12	6X17

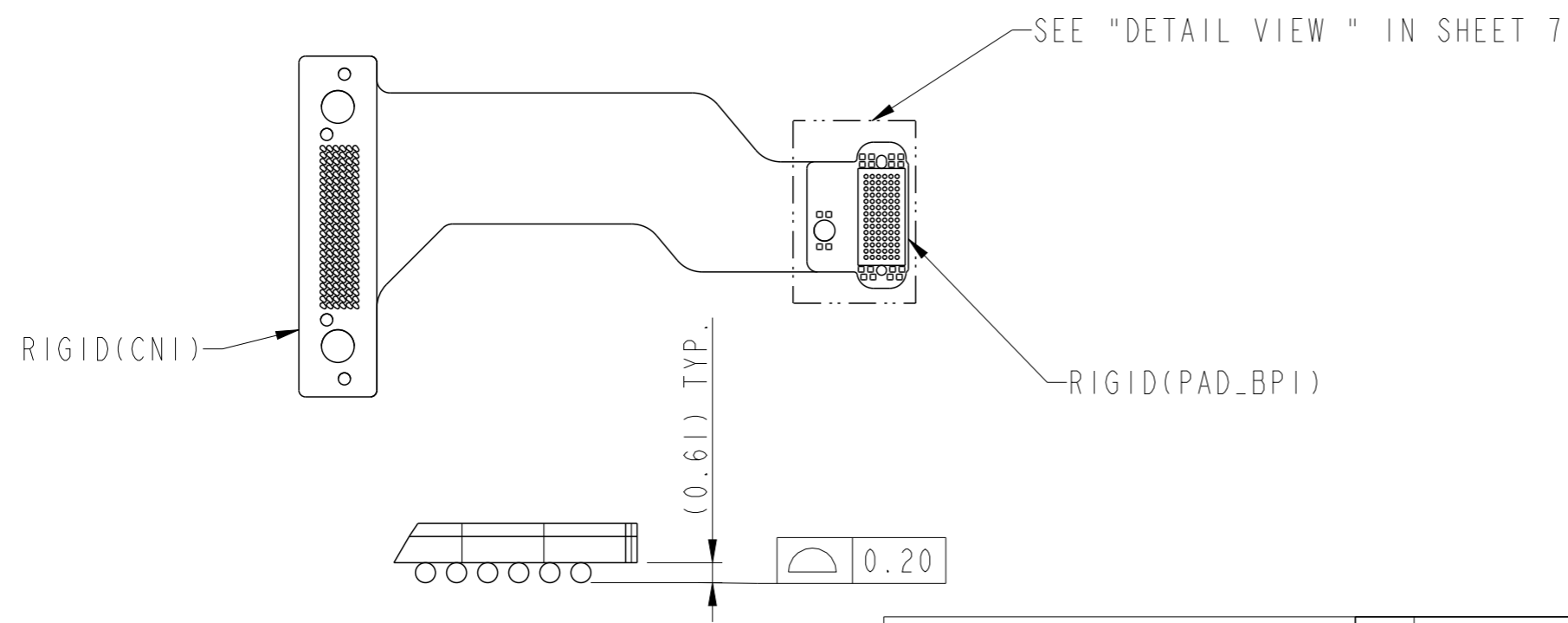
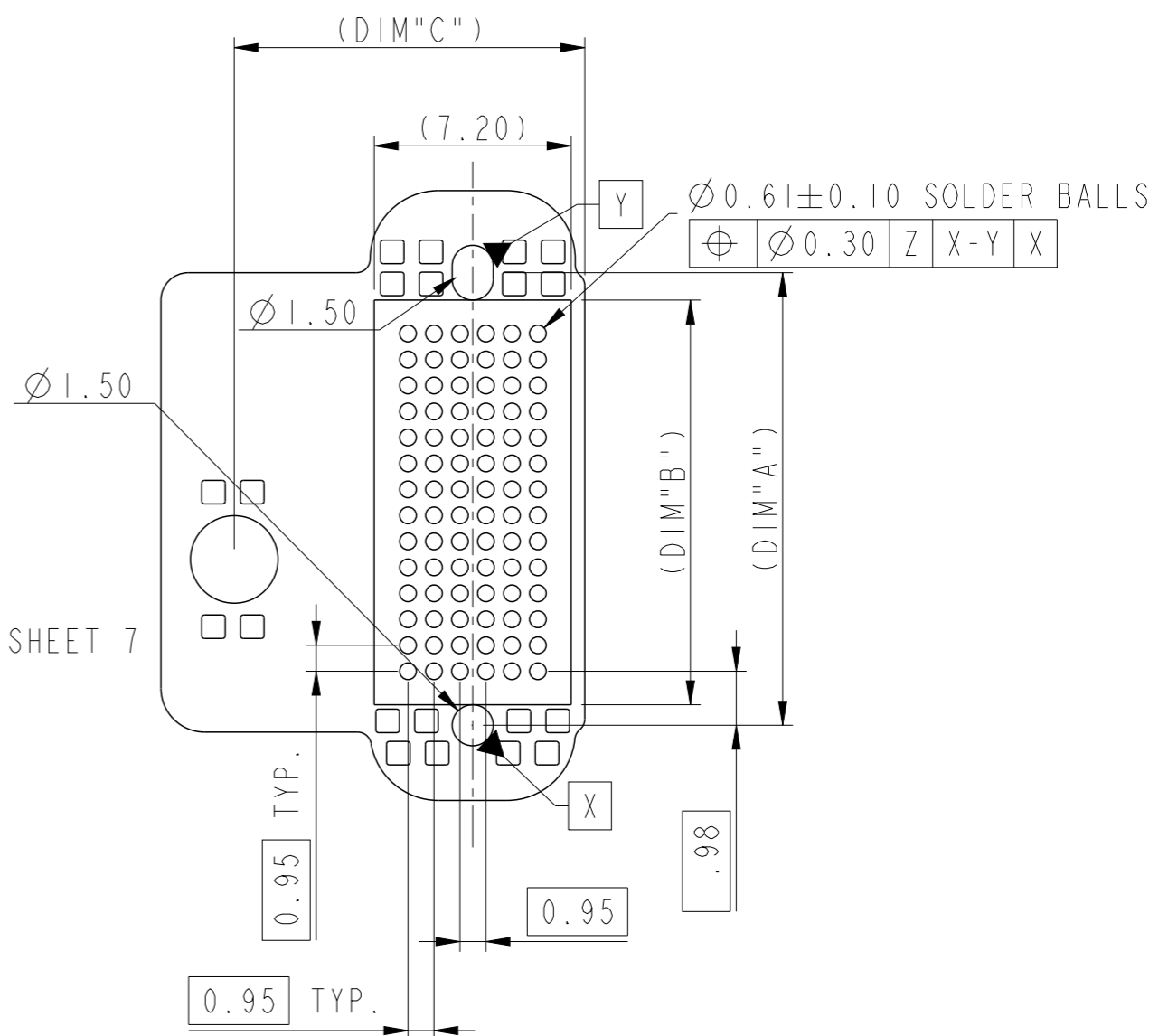
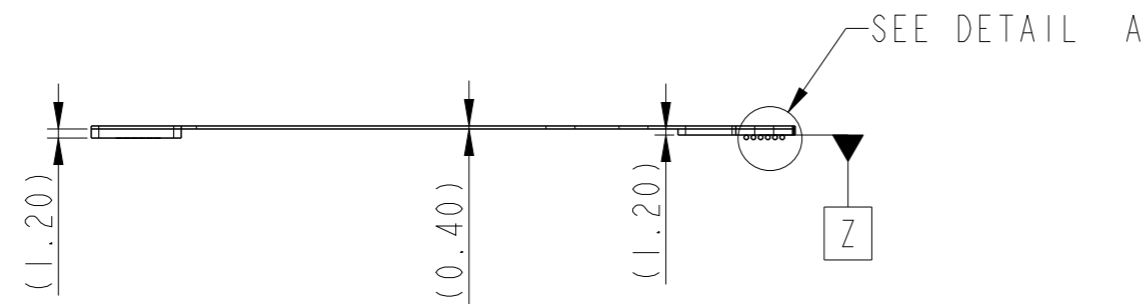
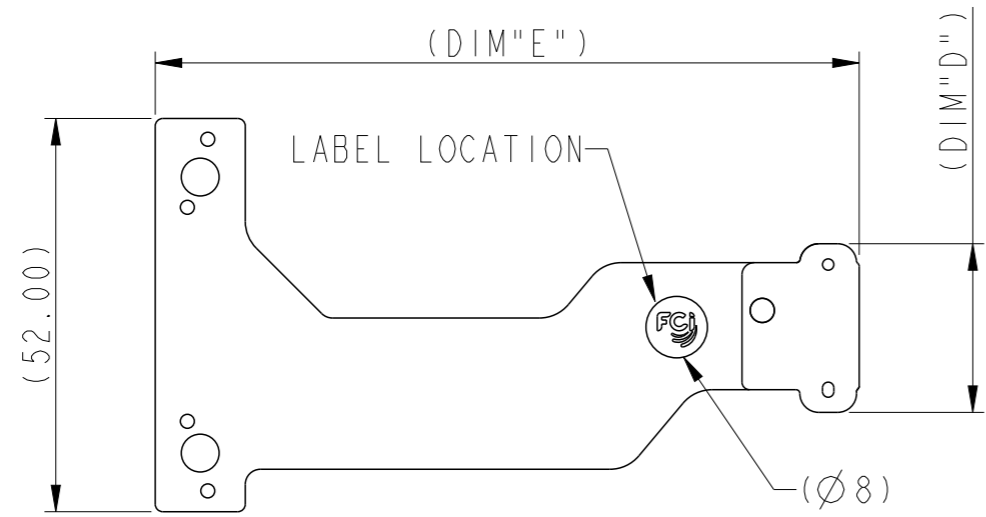

DETAIL A
SCALE 5:1

SCALE 4:1

spec ref	dr	Zhen Luo	2014/03/14	projection	MM	size	A3	scale	1:1
tolerance std	eng	Michael Song	2017/04/13			ecn no	ELX-DG-26616-1	rel level	Released
ASME Y14.5	chr	-	-						
surface linear ASME Y14.5 angular	0.X	±0.30	Amphenol FCI www.fci.com	title Flex Cable BGA	dwg no 10127624	rev C			
	0.XX	±0.20							
	0.XXX	±0.10							
ASME Y14.5	angular	0°	±2°	cat. no.	-	Product - Customer Drw	sheet 1 of 7		

© 2016 AFCI
 Amphenol FCI

Product P/N	Flex Cable P/N In Wistron	DIM"A"	DIM"B"	DIM"C"	DIM"D"	BGA Array Pattern
10127624-13611XXLF	13611	16.55	14.80	22.0	81.73	6X14
10127624-13614XXLF	13614	26.05	24.30	31.50	79.38	6X24
10127624-13658XXLF	13658	15.60	13.85	31.50	79.43	6X13

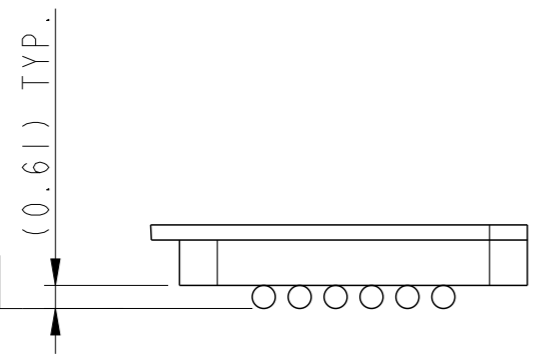
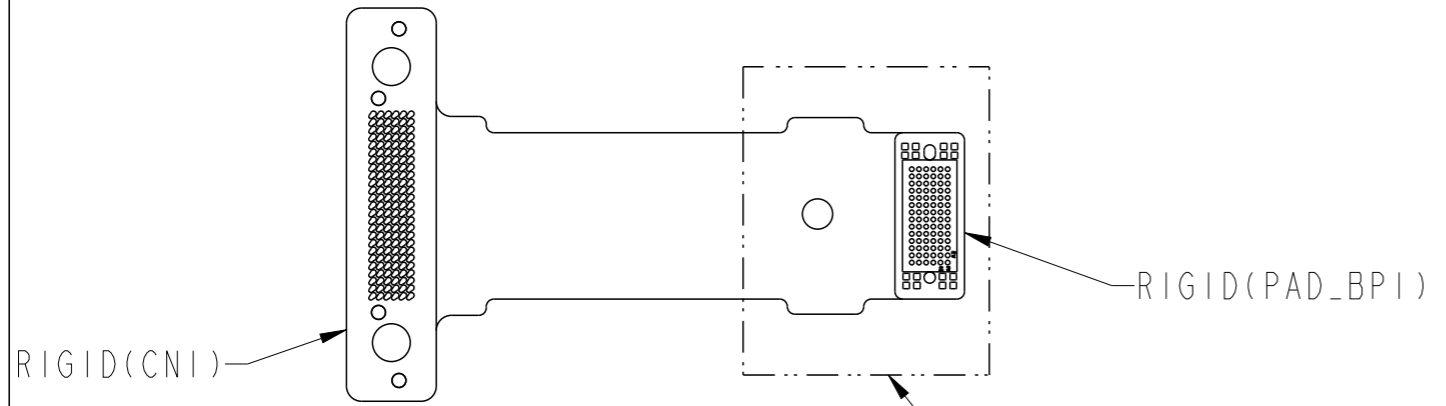
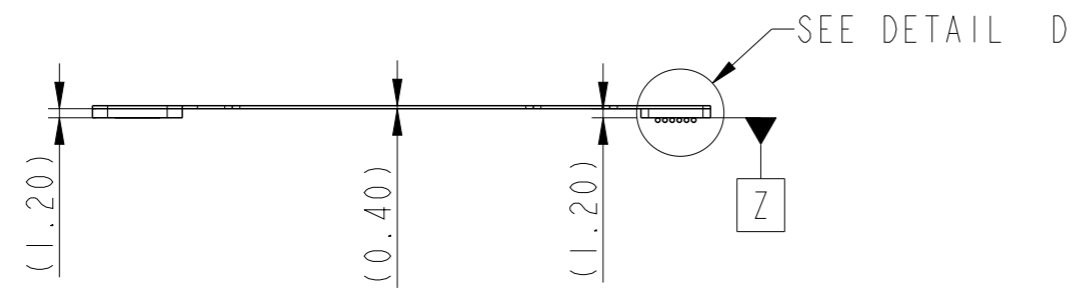
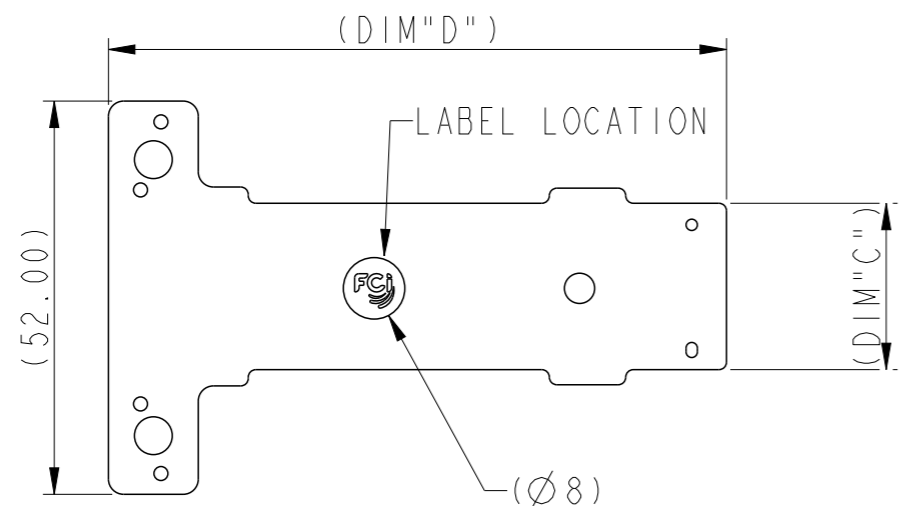

DETAIL D
SCALE 5:1

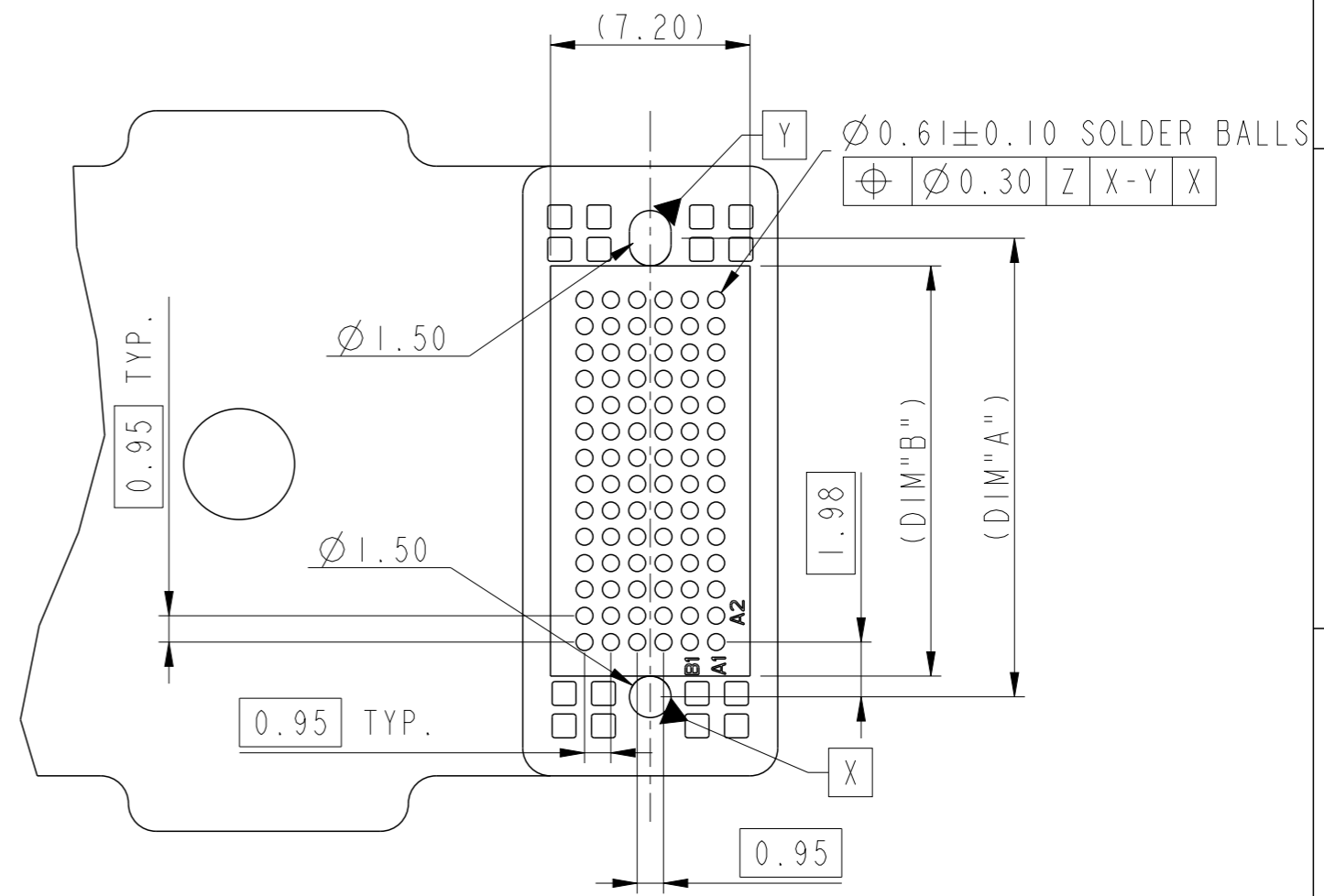

SCALE 4:1

spec ref	dr	Zhen Luo	2014/03/14	projection	MM	size	A3	scale	1:1
tolerance std	eng	Michael Song	2017/04/13			ecn no	ELX-DG-26616-1	rel level	Released
ASME Y14.5	chr	-	product family						
TOLERANCES UNLESS OTHERWISE SPECIFIED		appr	Heaven Cen	product family		rel level		Released	
surface	linear	0.X	±0.30	title		dwg no		rev	
		0.XX	±0.20	Flex Cable BGA		10127624		C	
		0.XXX	±0.10	www.fci.com					
ASME Y14.5	angular	0°	±2°	cat. no.		Product - Customer Drw		sheet 2 of 7	

Amphenol
FCi

© 2016 AFCI

Product P/N	Flex Cable P/N In Wistron	DIM"A"	DIM"B"	DIM"C"	BGA Array Pattern
10127624-13612XXLF	13612	16.55	14.80	22.0	6X14
10127624-13616XXLF	13616	27.0	25.25	32.45	6X25

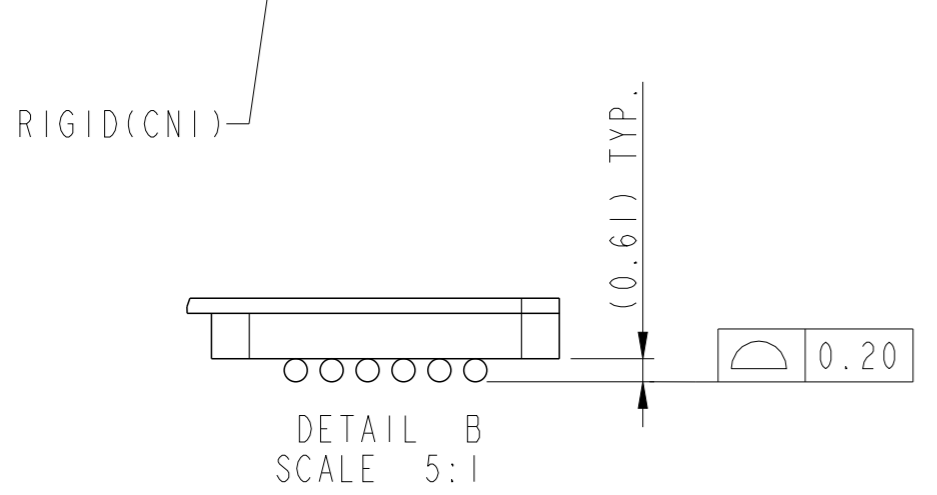
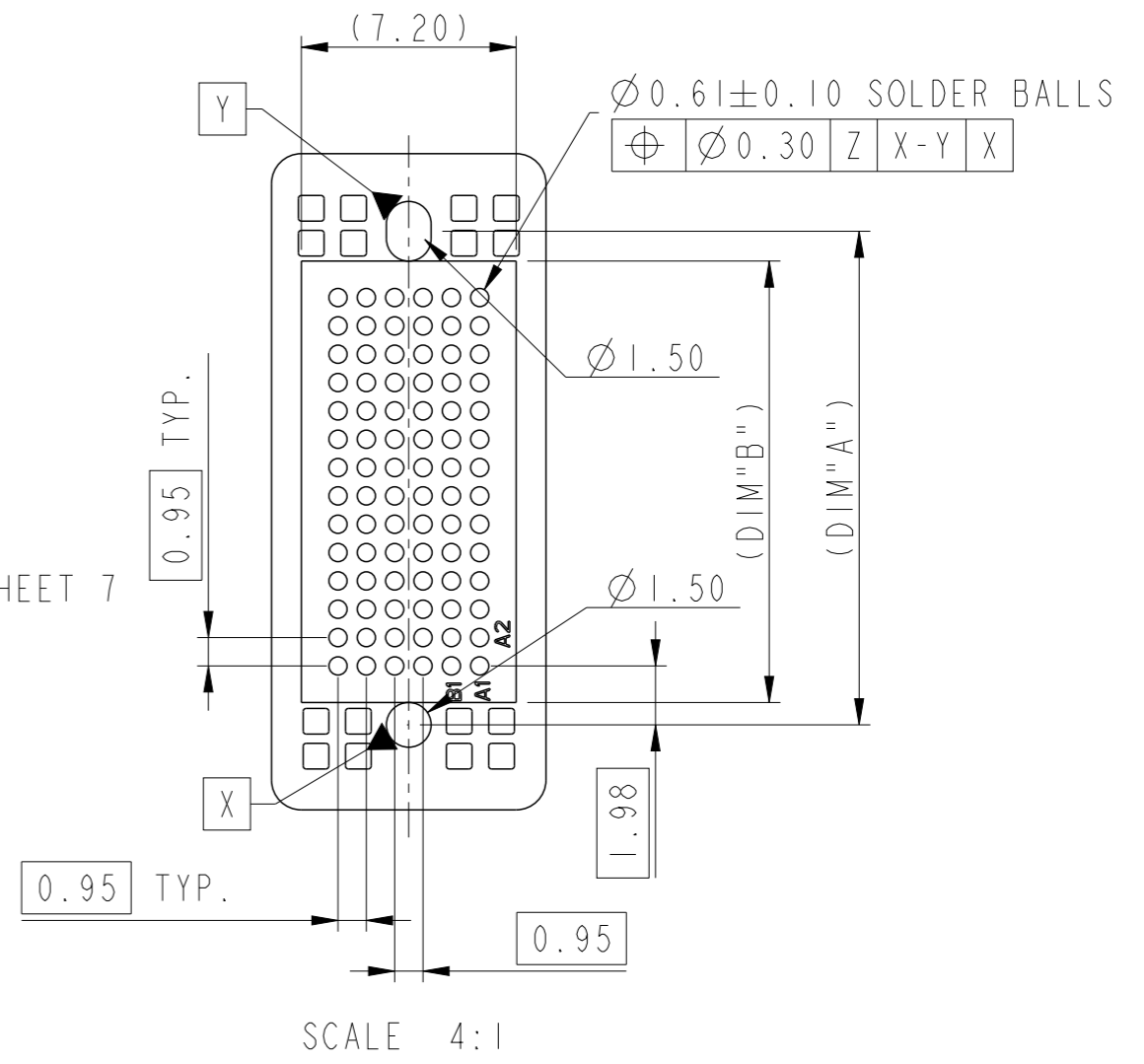
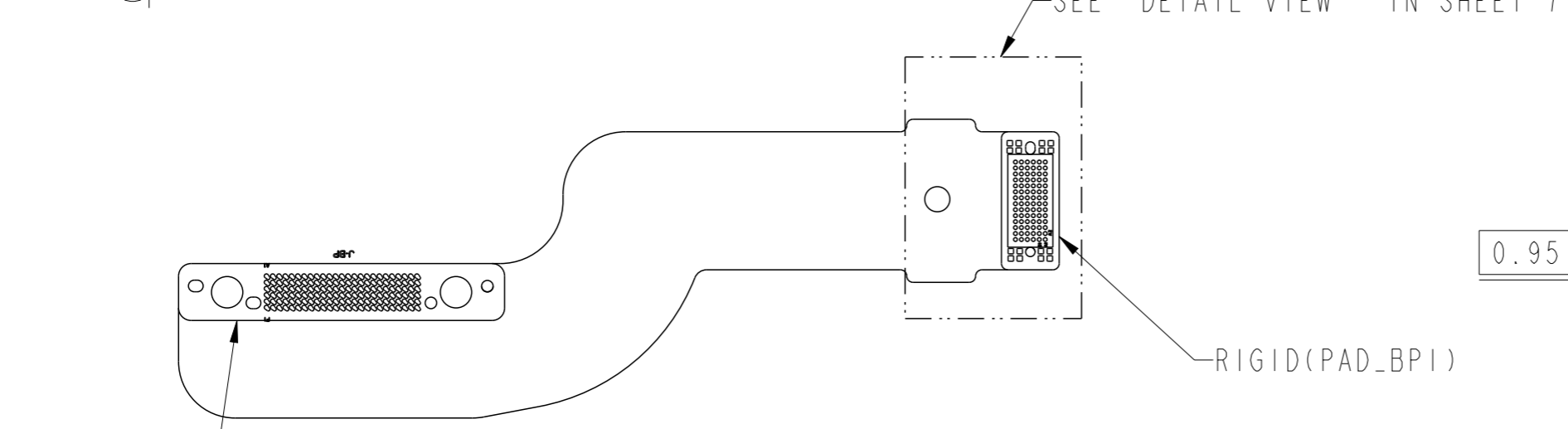
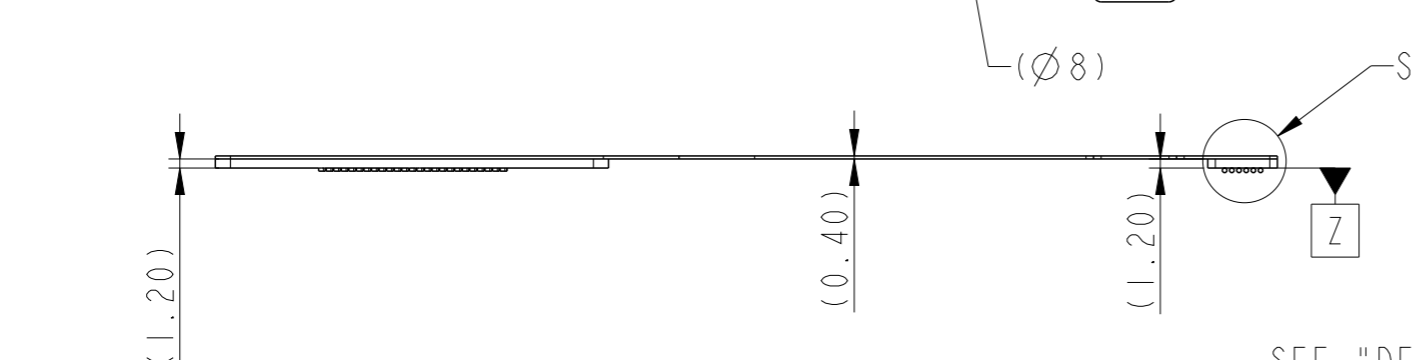
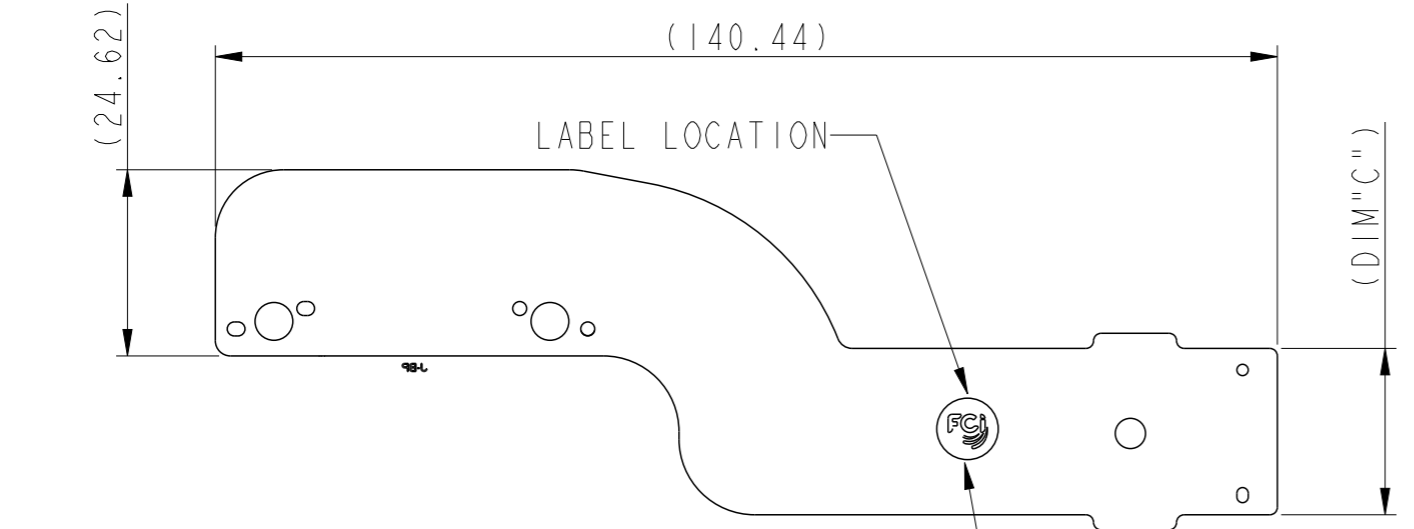

spec ref	dr	Zhen Luo	2014/03/14	projection	MM	size	A3	scale	1:1
tolerance std	eng	Michael Song	2017/04/13			ecn no	ELX-DG-26616-1	rel level	Released
ASME Y14.5	chr	-	product family						
TOLERANCES UNLESS OTHERWISE SPECIFIED		appr	Heaven Cen	product family		-		-	
surface	linear	0.X	±0.30	Flex Cable BGA		dwg no		10127624	
		0.XX	±0.20	www.fci.com		rev		C	
		0.XXX	±0.10	cat. no.		-		Product - Customer Drw	
ASME Y14.5	angular	0°	±2°	-		-		sheet 3 of 7	

Amphenol
FCi

© 2016 AFCI

Product P/N	Flex Cable P/N In Wistron	DIM"A"	DIM"B"	DIM"C"	DIM"D"	DIM"E"	BGA Array Pattern
10127624-13610XXLF	13610	27.0	25.25	12.82	32.75	151.11	6X25
10127624-13613XXLF	13613	19.40	17.65	11.36	25.15	159.14	6X17
10127624-13615XXLF	13615	16.55	14.80	12.82	22.30	151.10	6X14

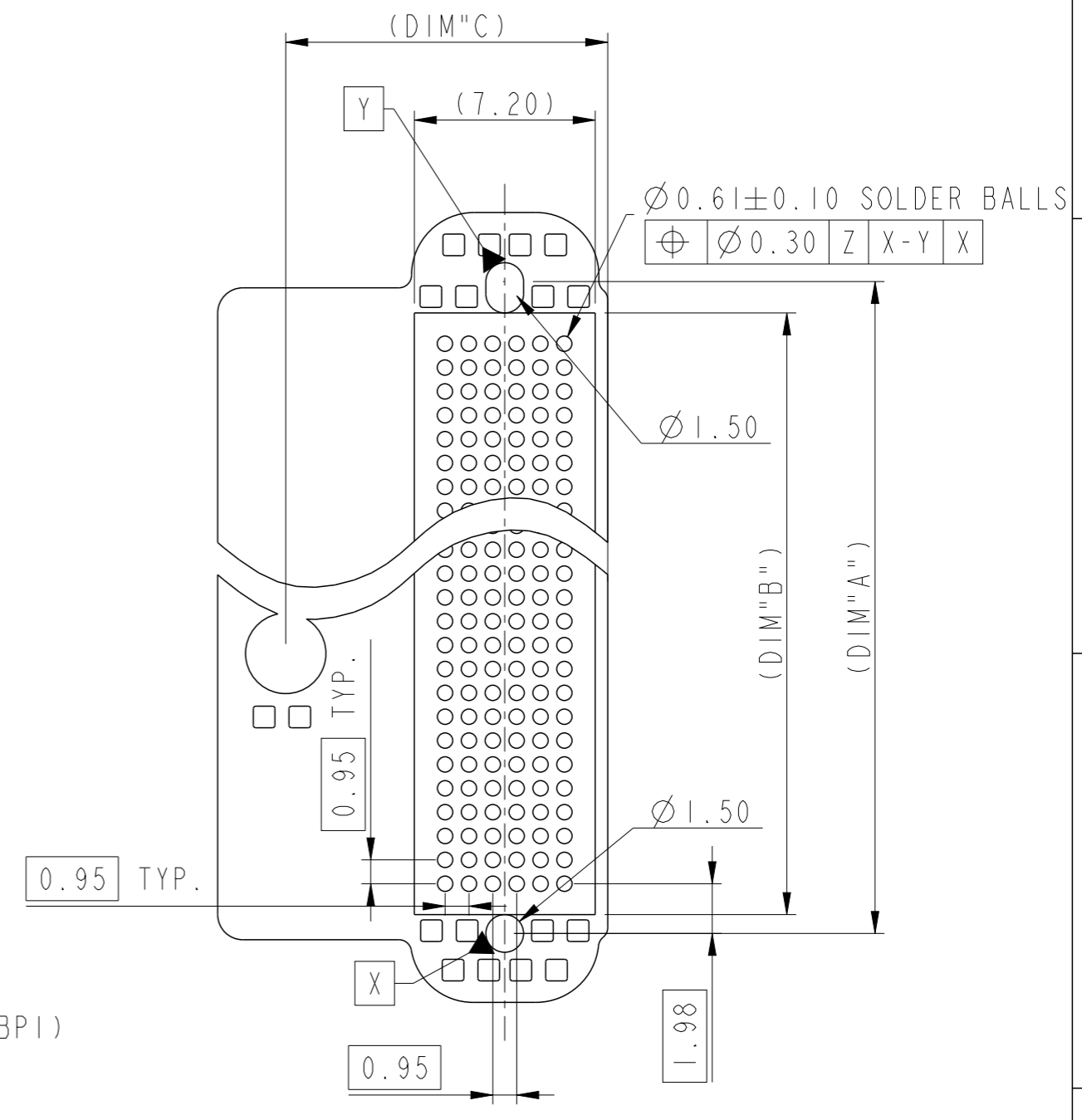
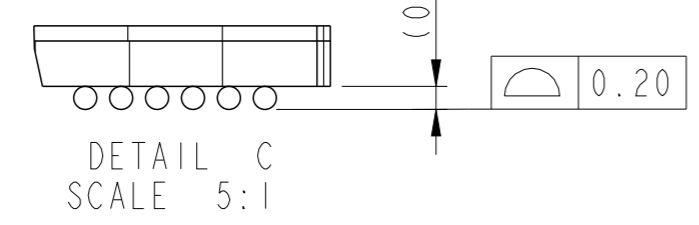
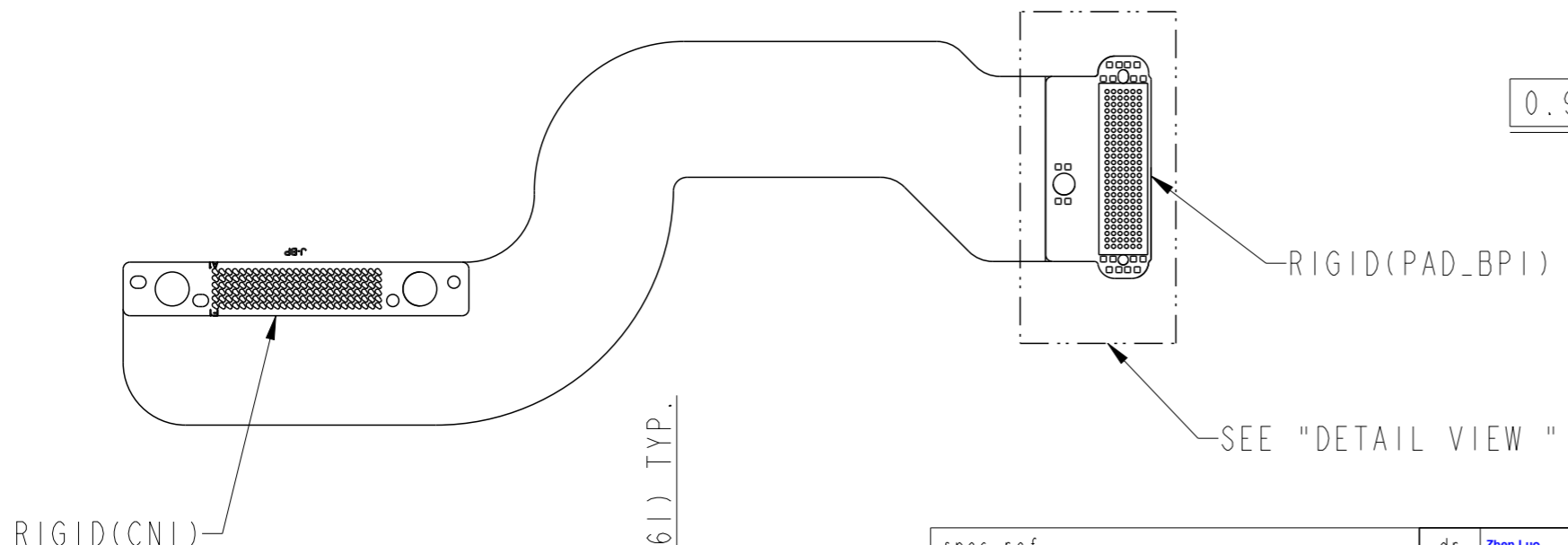
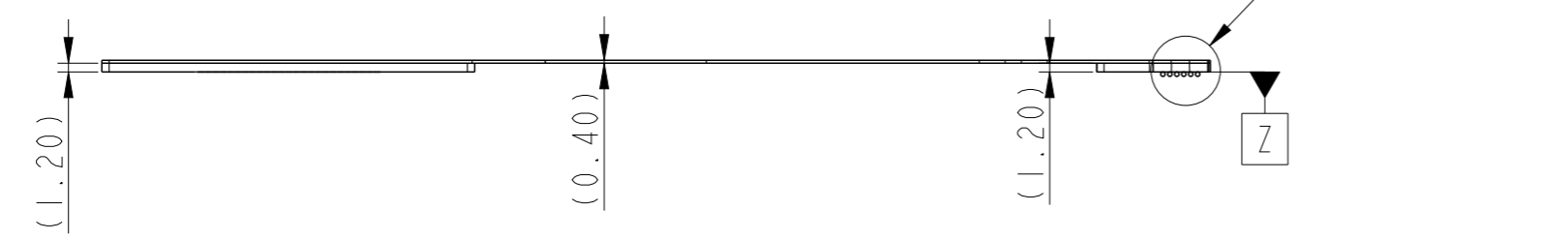
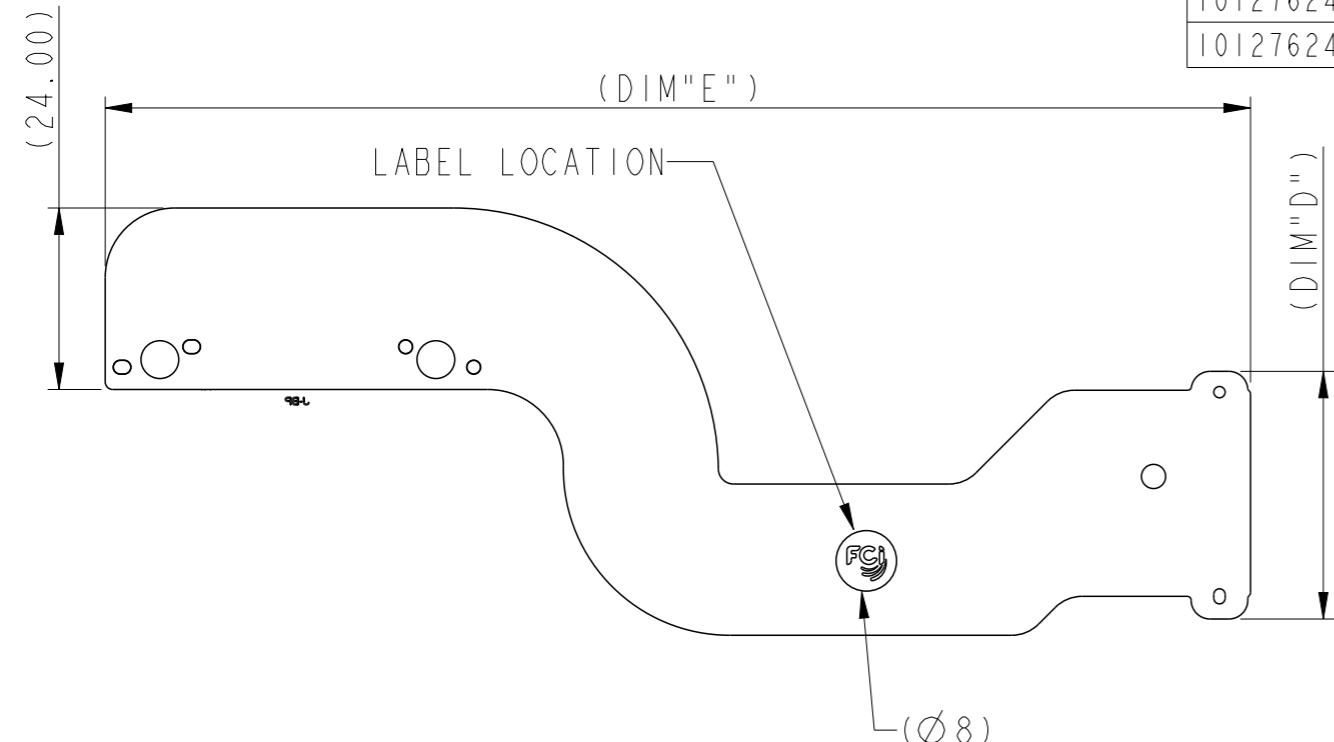

spec ref	dr	Zhen Luo	2014/03/14	projection	MM	size	A3	scale	1:1
tolerance std	eng	Michael Song	2017/04/13			ecn no	ELX-DG-26616-1	rel level	Released
ASME Y14.5	chr	-	product family						
TOLERANCES UNLESS OTHERWISE SPECIFIED		Amphenol FCI		Flex Cable BGA		dwg no		10127624	
surface	linear	0.X	±0.30	www.fci.com		cat. no.		-	
		0.XX	±0.20	Product - Customer Drw		sheet 4 of 7		rev	
		0.XXX	±0.10	PDS: Rev :C		STATUS:Released		Printed: Apr 13, 2017	
ASME Y14.5	angular	0°	±2°	Product - Customer Drw		sheet 4 of 7		C	

Product P/N	Flex Cable P/N In Wistron	BGA Array Pattern
10127624-13961XXLF	13961	6X25

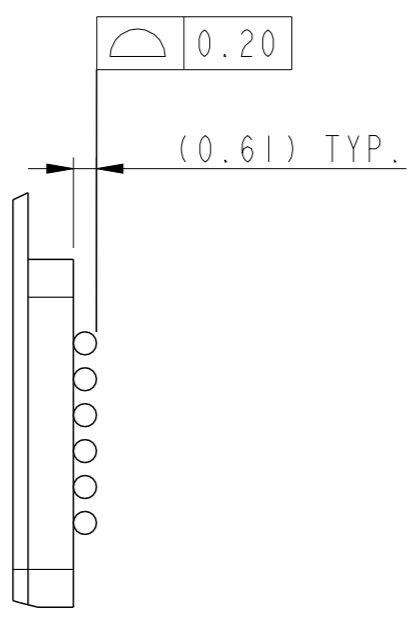
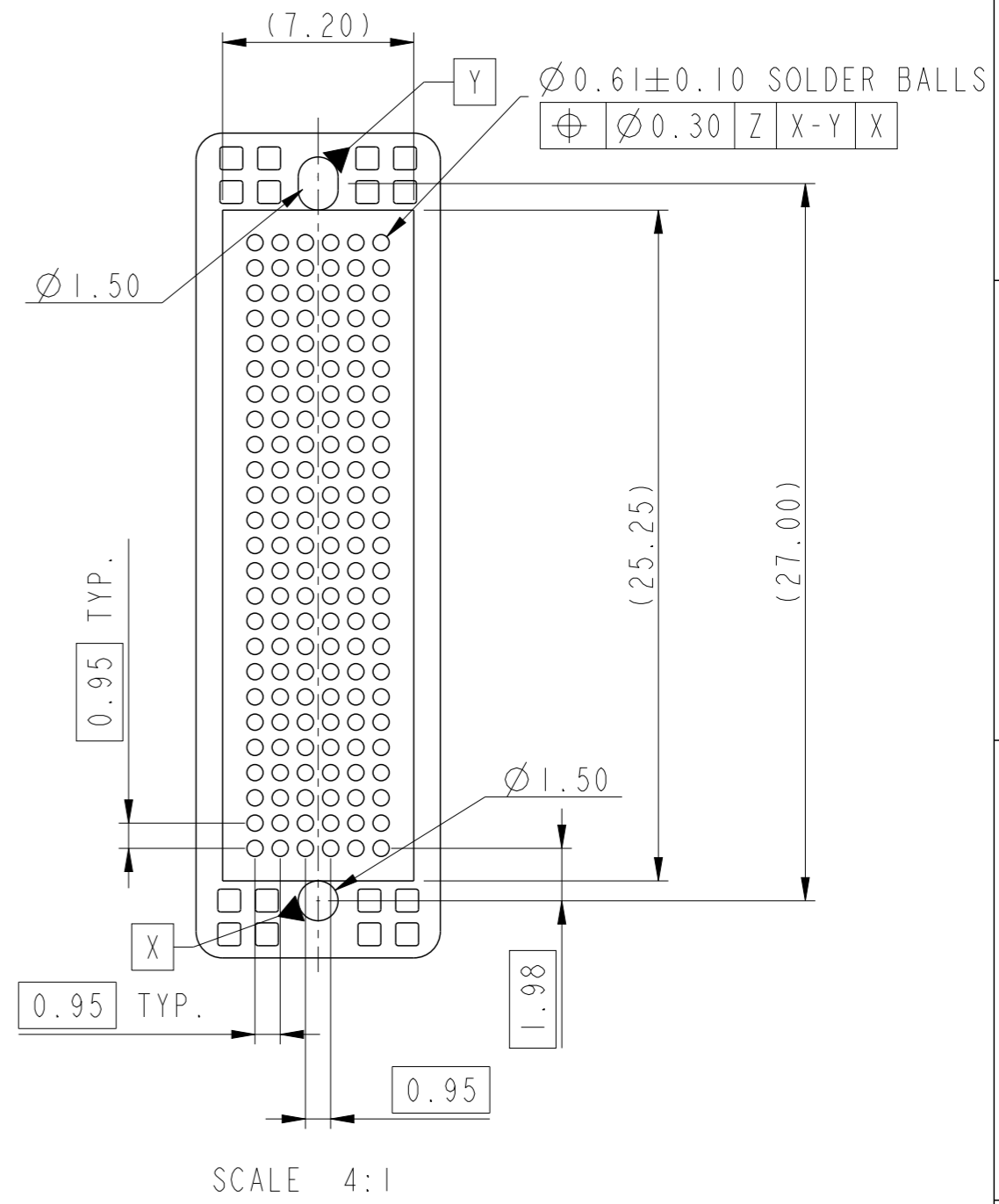
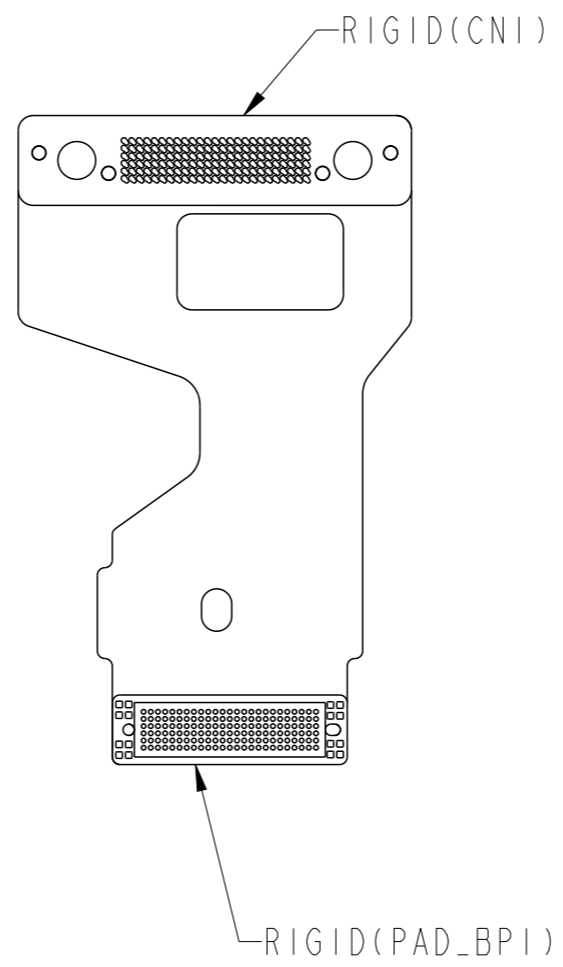
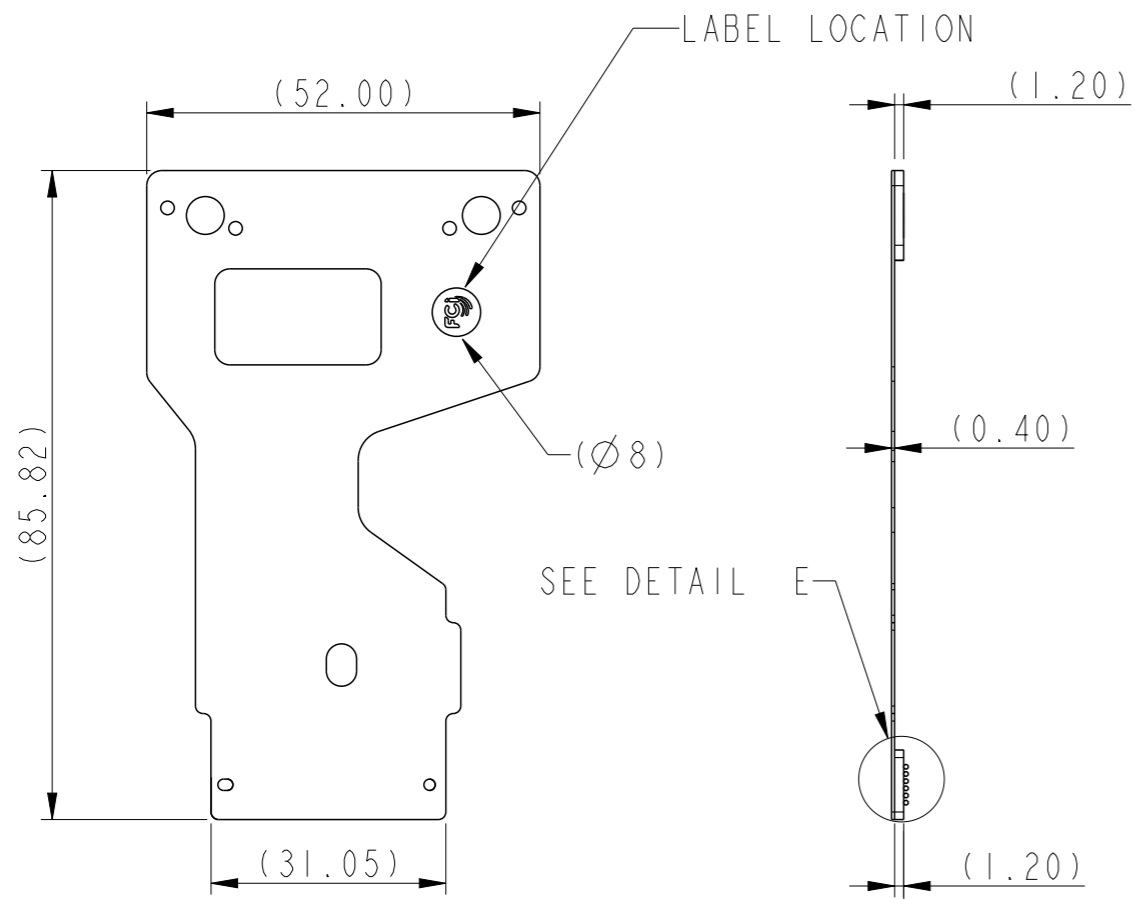

DETAIL E
SCALE 5:1

spec ref	dr	Zhen Luo	2014/03/14	projection	MM	size	A3	scale	1:1			
tolerance std	eng	Michael Song	2017/04/13			ecn no	ELX-DG-26616-1	rel level	Released			
ASME Y14.5	chr	-	-									
TOLERANCES UNLESS OTHERWISE SPECIFIED				product family	-							
surface	linear	0.X	±0.30	Amphenol FCI		title	Flex Cable BGA		dwg no	10127624	rev	C
		0.XX	±0.20	www.fci.com		cat. no.	-	Product - Customer Drw	sheet 5 of 7			
		0.XXX	±0.10									
ASME Y14.5	angular	0°	±2°									

Amphenol
FCi

© 2016 AFCI

Product P/N	Flex Cable P/N In Wistron	BGA Array Pattern
10127624-13962XXLF	13962	6X17

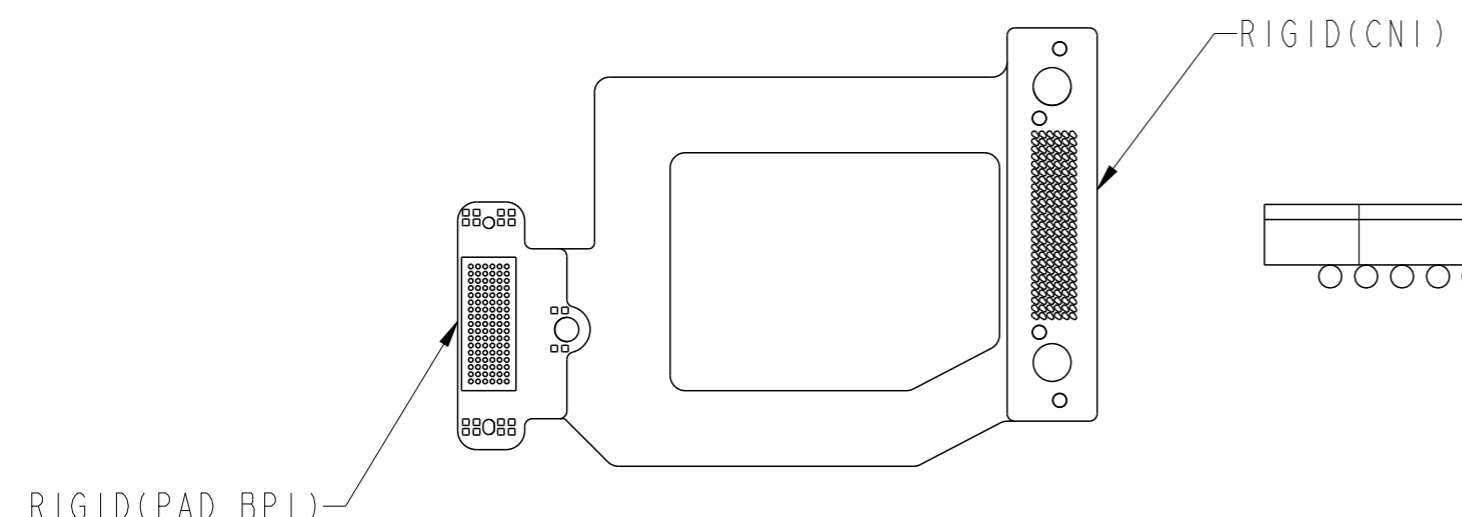
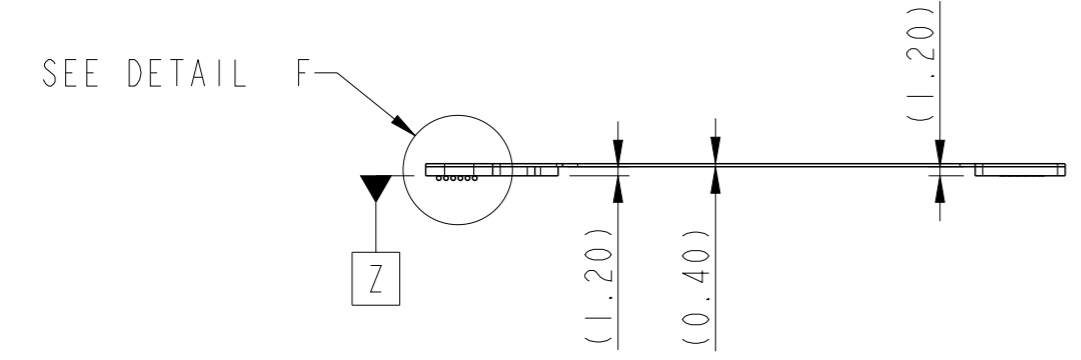
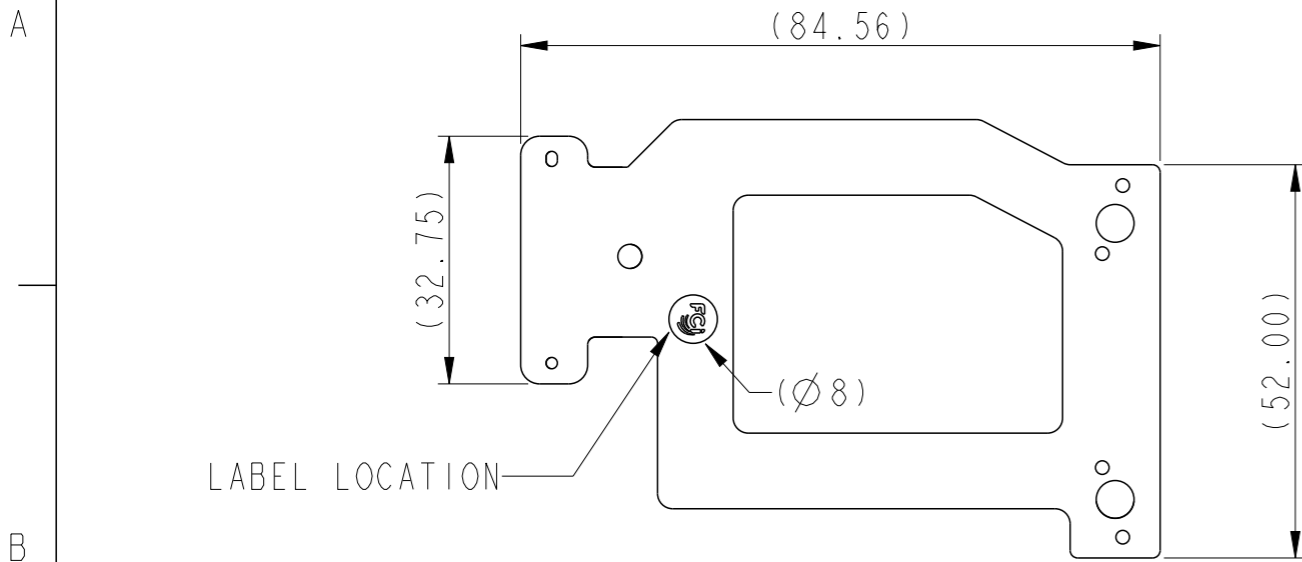

DETAIL F
SCALE 5:1

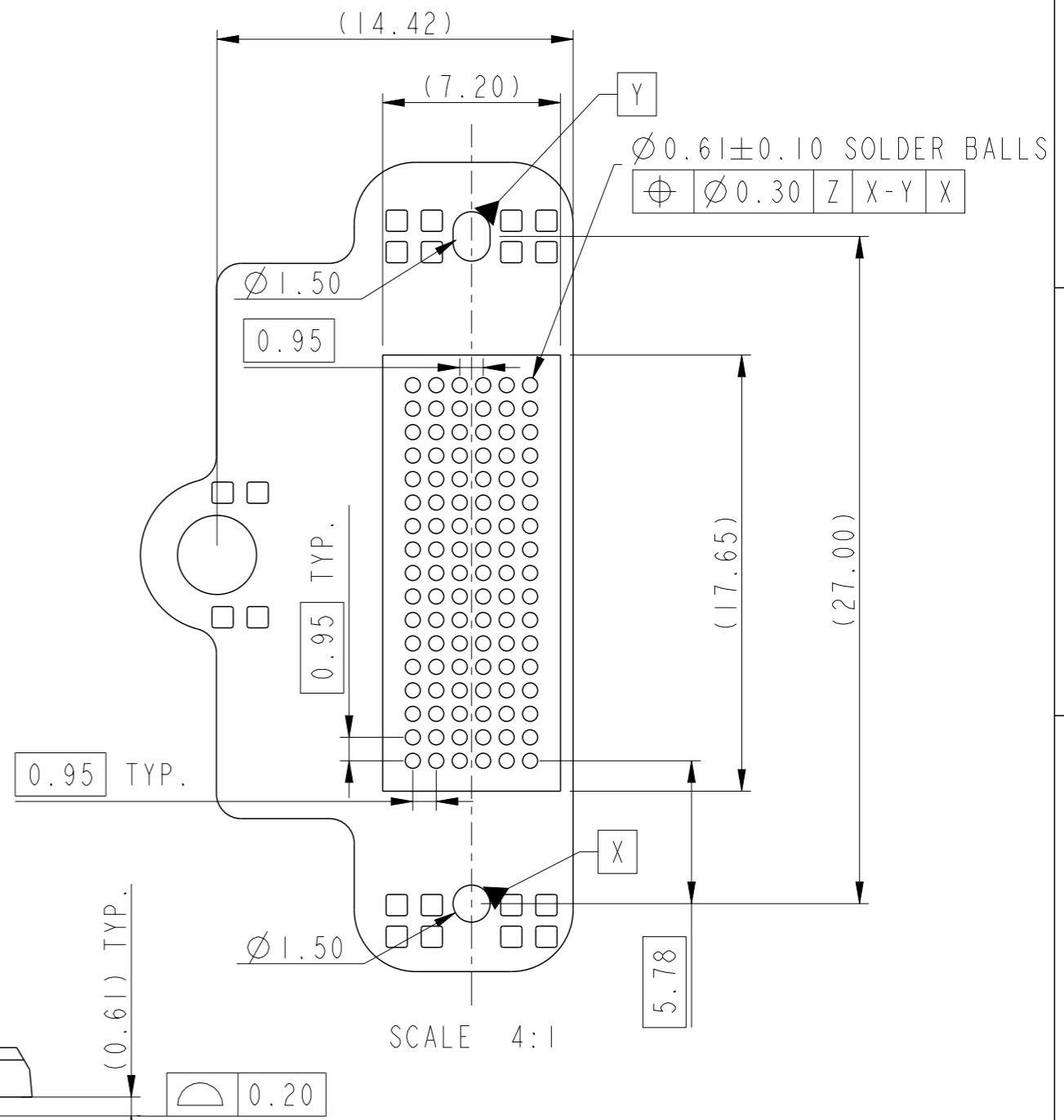

Ø0.61±0.10 SOLDER BALLS

⊕	Ø0.30	Z	X-Y	X
---	-------	---	-----	---

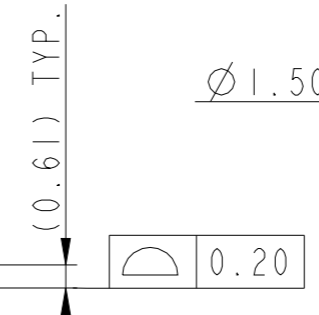

SCALE 4:1

spec ref	dr	Zhen Luo	2014/03/14	projection	MM	size	A3	scale	1:1		
tolerance std	eng	Michael Song	2017/04/13			ecn no	ELX-DG-26616-1	rel level	Released		
ASME Y14.5	chr	-	-								
TOLERANCES UNLESS OTHERWISE SPECIFIED				product family	-						
surface	linear	0.X	±0.30	Amphenol FCI www.fci.com	title Flex Cable BGA cat. no. -	dwg no 10127624	rev C				
		0.XX	±0.20					Product - Customer Drw		sheet 6 of 7	
ASME Y14.5	angular	0°	±2°					PDS: Rev :C		STATUS:Released	

Amphenol FCI

© 2016 AFCI

PRODUCT PART NUMBER

10127624-□□□□XXLF

BASE NUMBER

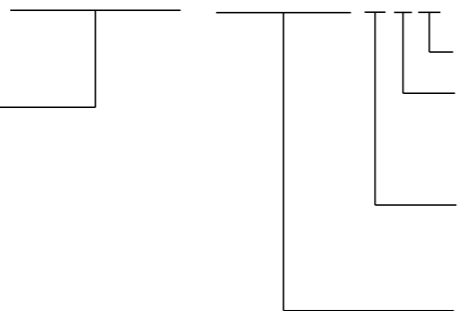

LEAD FREE
 PCB DESIGN:
 0: STANDARD
 I TO N: NEW STACKUP
 SUPPLIER:
 M: Multex
 T: TTM
 CODE (SEE TABLE)

- NOTES:
 1. MATERIAL:
 FLEX CABLE
 SOLDER BALL: LEAD FREE 96.5Sn/3Ag/0.5Cu
 2. SOLDER BALLS WILL NOT BE PERFECT SPHERICAL SHAPE DUE TO REFLOW ATTACHMENT.
 3. PRODUCT SPECIFICATION: GS-12-1183.
 4. APPLICATION SPECIFICATION: GS-20-0391.
 5. PACKAGE SPECIFICATION: GS-14-2365.
 6. PRODUCT MEET EUROPEAN UNION DIRECTIVES AND OTHER COUNTRY REGULATIONS DESCRIBED IN GS-22-08.

CODE	Flex Cable P/N In Wistron	DETAIL VIEW	CODE	Flex Cable P/N In Wistron	DETAIL VIEW	CODE	Flex Cable P/N In Wistron	DETAIL VIEW
13608	13608		13658	13658		13613	13613	
13609	13609		13612	13612		13615	13615	
13611	13611		13616	13616		13961	13961	
13614	13614		13610	13610		13962	13962	

Amphenol FCI © 2016 AFCI

spec ref	dr	Zhen Luo	2014/03/14	projection	MM	size	A3	scale	1:1
tolerance std	eng	Michael Song	2017/04/13		← →	ecn no		ELX-DG-26616-1	
ASME Y14.5	chr	-	-			rel level		Released	
surface	linear	0.X	±0.30	Amphenol FCI	Flex Cable BGA	dwg no	10127624	rev	C
		0.XX	±0.20						
ASME Y14.5	angular	0°	±2°	www.fci.com	cat. no.	-	Product - Customer Drw	sheet 7 of 7	



Компания «ЭлектроПласт» предлагает заключение долгосрочных отношений при поставках импортных электронных компонентов на взаимовыгодных условиях!

Наши преимущества:

- Оперативные поставки широкого спектра электронных компонентов отечественного и импортного производства напрямую от производителей и с крупнейших мировых складов;
- Поставка более 17-ти миллионов наименований электронных компонентов;
- Поставка сложных, дефицитных, либо снятых с производства позиций;
- Оперативные сроки поставки под заказ (от 5 рабочих дней);
- Экспресс доставка в любую точку России;
- Техническая поддержка проекта, помощь в подборе аналогов, поставка прототипов;
- Система менеджмента качества сертифицирована по Международному стандарту ISO 9001;
- Лицензия ФСБ на осуществление работ с использованием сведений, составляющих государственную тайну;
- Поставка специализированных компонентов (Xilinx, Altera, Analog Devices, Intersil, Interpoint, Microsemi, Aeroflex, Peregrine, Syfer, Eurofarad, Texas Instrument, Miteq, Cobham, E2V, MA-COM, Hittite, Mini-Circuits, General Dynamics и др.);

Помимо этого, одним из направлений компании «ЭлектроПласт» является направление «Источники питания». Мы предлагаем Вам помощь Конструкторского отдела:

- Подбор оптимального решения, техническое обоснование при выборе компонента;
- Подбор аналогов;
- Консультации по применению компонента;
- Поставка образцов и прототипов;
- Техническая поддержка проекта;
- Защита от снятия компонента с производства.



Как с нами связаться

Телефон: 8 (812) 309 58 32 (многоканальный)

Факс: 8 (812) 320-02-42

Электронная почта: org@eplast1.ru

Адрес: 198099, г. Санкт-Петербург, ул. Калинина, дом 2, корпус 4, литера А.