



Photocoupler

Product Data Sheet

6N137 series

Spec No.: DS70-2008-0035

Effective Date: 04/25/2014

Revision: B

LITE-ON DCC

RELEASE

BNS-OD-FC001/A4

PHOTOCOUPLER 6N137 series

1. DESCRIPTION

The 6N137 consists of a high efficient AlGaAs Light Emitting Diode and a high speed optical detector. This design provides excellent AC and DC isolation between the input and output sides of the Optocoupler. The output of the optical detector features an open collector Schottky clamped transistor. The enable function allows the optical detector to be strobed. A guaranteed common mode transient immunity is up to 10kV/ μ s at 3.3V.

The Optocoupler operational parameters are guaranteed over the temperature range from $-40^{\circ}\text{C} \sim +85^{\circ}\text{C}$.

1.1 Features

- 3.3V / 5V Dual Supply Voltages
- Low power consumption
- High speed – 15MBd typical
- 10kV/ μ s minimum Common Mode Rejection (CMR) at $V_{\text{CM}} = 1000\text{V}$
- Guaranteed AC and DC performance over temperature $-40^{\circ}\text{C} \sim +85^{\circ}\text{C}$.
- LVTTTL/LVCMOS Compatible.
- Available in Dual-in-line, Wide lead spacing, Surface mounting package.
- Strobable output.
- Safety approval
UL/ cUL 1577, 5000 Vrms/1 min
VDE DIN EN60747-5-5, $V_{\text{IORM}} = 567 \text{ Vpeak}$

1.2 Applications

- Isolation in line receivers
- Digital isolation for A/D, D/A conversion
- Ground loop elimination
- Feedback Element in Switching Mode Power Supplier
- Pulse transformer replacement
- Power transistor isolation in motor drives
- Interface between Microprocessor system, computer and their peripheral

1.3 Functional Diagram

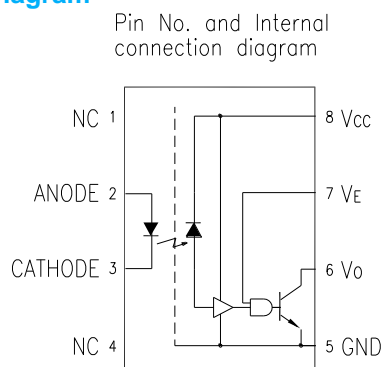

Truth Table (Positive Logic)

LED	ENABLE	OUT
ON	H	L
OFF	H	H
ON	L	H
OFF	L	H
ON	NC	L
OFF	NC	H

A 0.1 μ F bypass Capacitor must be connected between Pin8 and Pin5

PHOTOCOUPLER 6N137 series

2. PACKAGE DIMENSIONS

2.1 : 6N137

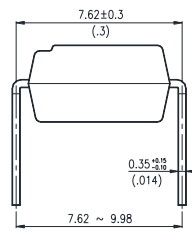
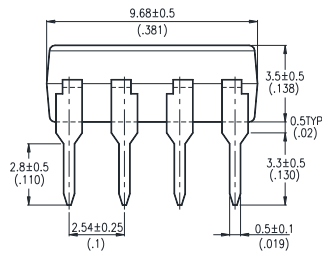

2.2 : 6N137M

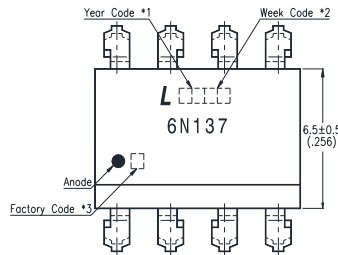

Notes :

1. Year date code.
 2. 2-digit work week.
 3. Factory identification mark (Y : Thailand).
- Dimensions are all in Millimeters.

**PHOTOCOUPLER
6N137 series**

2.3 : 6N137S

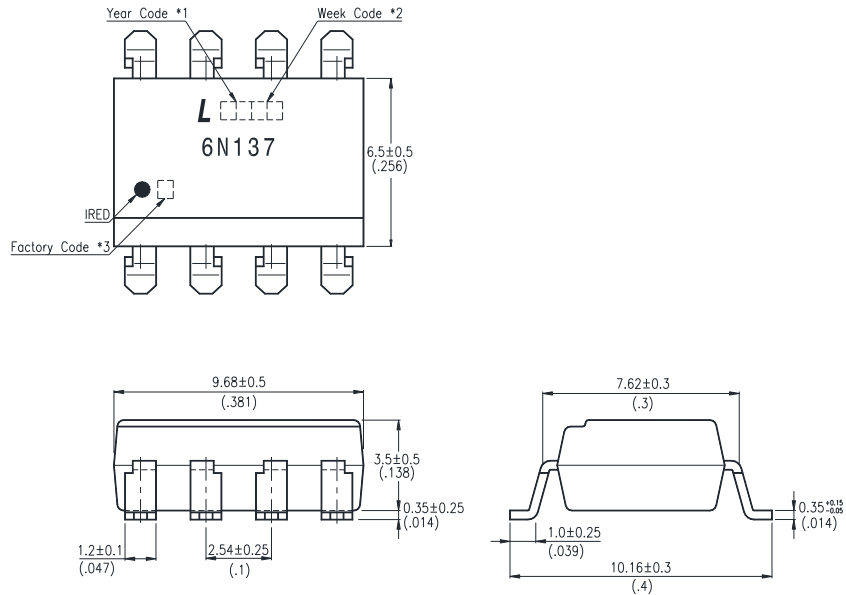

Notes :

1. Year date code.
2. 2-digit work week.
3. Factory identification mark (Y : Thailand).

Dimensions are all in Millimeters.

**PHOTOCOUPLER
6N137 series**

3. TAPING DIMENSIONS

3.1 : 6N137S-TA

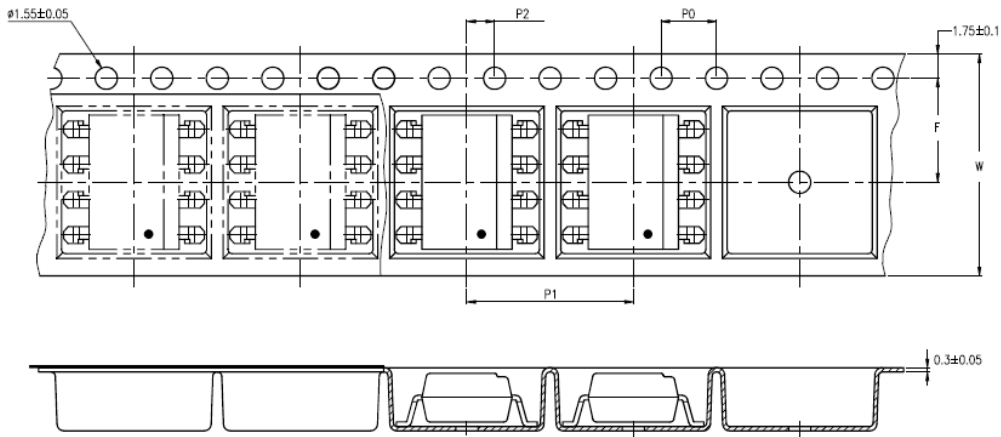

3.2 : 6N137S-TA1

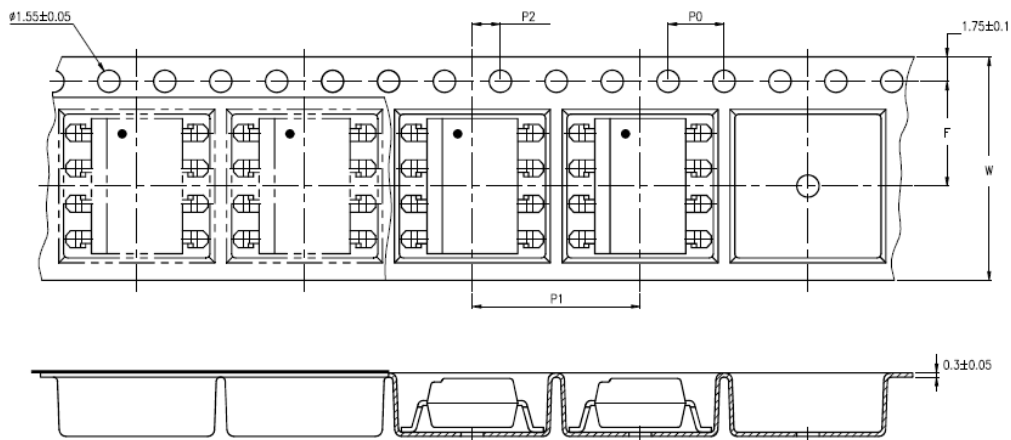

Description	Symbol	Dimension in mm (inch)
Tape wide	W	16±0.3 (0.63)
Pitch of sprocket holes	P_0	4±0.1 (0.15)
Distance of compartment	F	7.5±0.1 (0.295)
	P_2	2±0.1 (0.079)
Distance of compartment to compartment	P_1	8±0.1 (0.47)

Package Type	6N137
Quantities Per Reel (pcs)	1000

**PHOTOCOUPLER
6N137 series**

4. RATING AND CHARACTERISTICS

4.1 Absolute Maximum Ratings at Ta=25°C *1

	Parameter	Symbol	Rating	Unit	Note
Input	Average Forward Input Current	I_F	20	mA	2
	Reverse Input Voltage	V_R	5	V	
	Power Dissipation	P_I	40	mW	
	Enable Input Voltage	V_E	Vcc+0.5	V	
	Enable Input current	I_E	5	mA	
Output	Output Collector Current	I_O	50	mA	
	Output Collector Voltage	V_O	7	V	
	Output Collector Power Dissipation	P_O	85	mW	
	Isolation Voltage	V_{iso}	5000	V_{rms}	
	Supply Voltage	V_{CC}	7	V	
	Operating Temperature	T_{opr}	-40 ~ +85	°C	
	Storage Temperature	T_{stg}	-55 ~ +125	°C	
	Lead Solder Temperature *2	T_{sol}	260	°C	

1. Ambient temperature = 25°C, unless otherwise specified. Stresses exceeding the absolute maximum ratings can cause permanent damage to the device. Exposure to absolute maximum ratings for long periods of time can adversely affect reliability.
2. 260°C for 10 seconds. Refer to Lead Free Reflow Profile.

**PHOTOCOUPLER
6N137 series**

4.2 Recommended Operating Conditions

Parameter	Symbol	Min	Max	Unit
Operating Temperature	T_A	-40	85	°C
Supply Voltage	V_{CC}	2.7	3.6	V
		4.5	5.5	
Low Level Input Current	I_{FL}	0	250	μA
High Level Input Current	I_{FH}	5	15	mA
Low Level Enable Voltage	V_{EL}	0	0.8	V
High Level Enable Voltage	V_{EH}	2	V_{CC}	V
Output Pull-up Resistor	R_L	330	4k	Ω
Fan Out (at $R_L=1k\Omega$ per channel)	N	—	5	TTL Loads

PHOTOCOUPLER 6N137 series

4.3 ELECTRICAL OPTICAL CHARACTERISTICS at $T_A = 25^\circ\text{C}$

Parameter	Symbol	Min.	Typ.	Max.	Unit	Test Condition
Input						
Input Forward Voltage	V_F	—	1.38	1.70	V	$I_F = 10\text{mA}$
Input Forward Voltage Temperature Coefficient	$\Delta V_F / \Delta T$	—	-1.5	—	$\text{mV}/^\circ\text{C}$	$I_F = 10\text{mA}$
Input Reverse Voltage	BV_R	5.0	—	—	V	$I_R = 10\mu\text{A}$
Input Threshold Current	I_{TH}	—	1.5	5	mA	$V_E = 2\text{V}, V_{CC} = 3.3\text{V}, V_O = 0.6\text{V}$ $I_{OL} (\text{sinking}) = 13\text{mA}$
Input Capacitance	C_{IN}	—	34	—	pF	$f = 1\text{MHz}, V_F = 0\text{V}$
Detector						
High Level Supply Current	I_{CCH}	—	3.8	10	μA	$V_E = 0.5\text{V}, V_{CC} = 3.3\text{V}, I_F = 0\text{mA}$
Low Level Supply Current	I_{CCL}	—	5.8	13	mA	$V_E = 0.5\text{V}, V_{CC} = 3.3\text{V}, I_F = 10\text{mA}$
High Level Enable Current	I_{EH}	—	-0.19	-1.6	mA	$V_{CC} = 3.3\text{V}, V_E = 2\text{V}$
Low Level Enable Current	I_{EL}	—	-0.41	-1.6	mA	$V_{CC} = 3.3\text{V}, V_E = 0.5\text{V}$
High Level Enable Voltage	V_{EH}	2	—	—	V	
Low Level Enable Voltage	V_{EL}	—	—	0.8	V	
High Level Output Current	I_{OH}	—	5	100	μA	$V_E = 2\text{V}, V_{CC} = 3.3\text{V}, V_O = 3.3\text{V}, I_F = 250\mu\text{A}$
Low Level Output Voltage	V_{OL}	—	0.3	0.60	V	$V_E = 2\text{V}, V_{CC} = 3.3\text{V}, I_F = 5\text{mA}, I_{OL} (\text{sinking}) = 13\text{mA}$

Specified over recommended temperature ($T_A = -40^\circ\text{C}$ to $+85^\circ\text{C}$, $2.7\text{V} \leq V_{CC} \leq 3.6\text{V}$), $I_F = 7.5\text{mA}$ unless otherwise specified. All typicals at $T_A = 25^\circ\text{C}$, $V_{CC} = 3.3\text{V}$.

PHOTOCOUPLER 6N137 series

Parameter	Symbol	Min.	Typ.	Max.	Unit	Test Condition
Input						
Input Forward Voltage	V_F	—	1.38	1.70	V	$I_F = 10\text{mA}$
Input Forward Voltage Temperature Coefficient	$\Delta V_F / \Delta T$	—	-1.5	—	mV/°C	$I_F = 10\text{mA}$
Input Reverse Voltage	BV_R	5.0	—	—	V	$I_R = 10\mu\text{A}$
Input Threshold Current	I_{TH}	—	1.35	5	mA	$V_{CC} = 5.5\text{V}$, $V_O = 0.6\text{V}$ $I_{OL} > 13\text{mA}$
Input Capacitance	C_{IN}	—	34	—	pF	$f = 1\text{MHz}$, $V_F = 0\text{V}$
Detector						
High Level Supply Current	I_{CCH}	—	6.1	10	uA	$V_E = 0.5\text{V}$, $V_{CC} = 5.5\text{V}$, $I_F = 0\text{mA}$
Low Level Supply Current	I_{CCL}	—	8.3	13	mA	$V_E = 0.5\text{V}$, $V_{CC} = 5.5\text{V}$, $I_F = 10\text{mA}$
High Level Enable Current	I_{EH}	—	-0.6	-1.6	mA	$V_{CC} = 5.5\text{V}$, $V_E = 2\text{V}$
Low Level Enable Current	I_{EL}	—	-0.9	-1.6	mA	$V_{CC} = 5.5\text{V}$, $V_E = 0.5\text{V}$
High Level Enable Voltage	V_{EH}	2	—	—	V	
Low Level Enable Voltage	V_{EL}	—	—	0.8	V	
High Level Output Current	I_{OH}	—	0.9	100	μA	$V_E = 2\text{V}$, $V_{CC} = 5.5\text{V}$, $V_O = 5.5\text{V}$, $I_F = 250\mu\text{A}$
Low Level Output Voltage	V_{OL}	—	0.4	0.60	V	$V_{CC} = 5.5\text{V}$, $I_F = 5\text{mA}$, $I_{OL} (\text{sinking}) = 13\text{mA}$

Specified over recommended temperature ($T_A = -40^\circ\text{C}$ to $+85^\circ\text{C}$, $4.5\text{V} \leq V_{CC} \leq 5.5\text{V}$), $I_F = 7.5\text{mA}$ unless otherwise specified. All typicals at $T_A = 25^\circ\text{C}$, $V_{CC} = 5.0\text{V}$.

PHOTOCOUPLER 6N137 series

5 SWITCHING SPECIFICATION

Parameter	Symbol	Min.	Typ.	Max.	Unit	Test Condition	Note
Propagation Delay Time to High Output Level	t_{PLH}	25	48	90	ns	$R_L = 350\Omega, C_L = 15pF$	3
Propagation Delay Time to Low Output Level	t_{PHL}	25	35	75	ns		4
Pulse Width Distortion	$ t_{PLH} - t_{PHL} $	—	13	—	ns		—
Propagation Delay Skew	t_{PSK}	—	—	40			—
Output Rise Time (10 to 90%)	t_r	—	21	—	ns		—
Output Fall Time (90 to 10%)	t_f	—	6.6	—	ns		—
Propagation Delay Time of Enable from V_{EH} to V_{EL}	t_{ELH}	—	27	—	ns	$R_L = 350\Omega, C_L = 15pF, V_{EL} = 0V, V_{EH} = 3V$	5
Propagation Delay Time of Enable from V_{EL} to V_{EH}	t_{EHL}	—	9	—	ns	$R_L = 350\Omega, C_L = 15pF, V_{EL} = 0V, V_{EH} = 3V$	6

Specified over recommended temperature ($T_A = -40^\circ\text{C}$ to $+85^\circ\text{C}$, $2.7V \leq V_{CC} \leq 3.6V$), $I_F = 7.5\text{mA}$ unless otherwise specified. All typicals at $T_A = 25^\circ\text{C}$, $V_{CC} = 3.3V$.

Parameter	Symbol	Min.	Typ.	Max.	Unit	Test Condition	Note	
Propagation Delay Time to High Output Level	t_{PLH}	25	40	75	ns	$T_A = 25^\circ\text{C}$ $R_L = 350\Omega, C_L = 15pF$	3	
		—	—	100				
Propagation Delay Time to Low Output Level	t_{PHL}	25	32	75	ns	$T_A = 25^\circ\text{C}$ $R_L = 350\Omega, C_L = 15pF$	4	
		—	—	100				
Pulse Width Distortion	$ t_{PLH} - t_{PHL} $	—	8	—	ns	$R_L = 350\Omega, C_L = 15pF$	—	
Propagation Delay Skew	t_{PSK}	—	—	40			—	
Output Rise Time (10 to 90%)	t_r	—	22	—	ns		—	
Output Fall Time (90 to 10%)	t_f	—	6.9	—	ns		—	
Propagation Delay Time of Enable from V_{EH} to V_{EL}	t_{ELH}	—	28	—	ns		$R_L = 350\Omega, C_L = 15pF, V_{EL} = 0V, V_{EH} = 3V$	5
Propagation Delay Time of Enable from V_{EL} to V_{EH}	t_{EHL}	—	12	—	ns		$R_L = 350\Omega, C_L = 15pF, V_{EL} = 0V, V_{EH} = 3V$	6

Specified over recommended temperature ($T_A = -40^\circ\text{C}$ to $+85^\circ\text{C}$, $4.5V \leq V_{CC} \leq 5.5V$), $I_F = 7.5\text{mA}$ unless otherwise specified. All typicals at $T_A = 25^\circ\text{C}$, $V_{CC} = 5.0V$.

PHOTOCOUPLER 6N137 series

Parameter	Symbol	Min.	Typ.	Max.	Unit	Test Condition	Note
Logic High Common Mode Transient Immunity	CM _H	10	15	—	kV/μs	V _{CC} = 3.3V V _{CM} = 1000V R _L = 350Ω I _F = 0mA T _A = 25°C	7
		10	15	—		V _{CC} = 5V V _{CM} = 1000V R _L = 350Ω I _F = 0mA T _A = 25°C	
Logic Low Common Mode Transient Immunity	CM _L	10	15	—	kV/μs	V _{CC} = 3.3V V _{CM} = 1000V R _L = 350Ω I _F = 10.0mA T _A = 25°C	8
		10	15	—		V _{CC} = 5V V _{CM} = 1000V R _L = 350Ω I _F = 10.0mA T _A = 25°C	

PHOTOCOUPLER 6N137 series

6 ISOLATION CHARACTERISTIC

Parameter	Symbol	Min.	Typ.	Max.	Unit	Test Condition	Note
Input-Output Insulation Leakage Current	I_{I-O}	—	—	1.0	μA	45% RH, $t = 5s$, $V_{I-O} = 3kV$ DC, $T_A = 25^\circ C$	9
Withstand Insulation Test Voltage	V_{ISO}	5000	—	—	V_{RMS}	RH $\leq 50\%$, $t = 1min$, $T_A = 25^\circ C$	9, 10
Input-Output Resistance	R_{I-O}	—	10^{12}	—	Ω	$V_{I-O} = 500V$ DC	9,
Input-Output Capacitance	C_{I-O}	—	1.0	—	p	$f = 1MHz$, $T_A = 25^\circ C$	9,

Specified over recommended temperature ($T_A = -40^\circ C$ to $+85^\circ C$) unless otherwise specified. Typical values applies to $T_A = 25^\circ C$

Notes

1. A 0.1 μF or bigger bypass capacitor for V_{CC} is needed as shown in Fig.1
2. Peaking driving circuit may be used to speed up the LED. The peak drive current of LED may go up to 50mA and maximum pulse width 50ns, as long as average current doesn't exceed 20mA.
3. t_{PLH} (propagation delay) is measured from the 3.75 mA point on the falling edge of the input pulse to the 1.5 V point on the rising edge of the output pulse.
4. t_{PHL} (propagation delay) is measured from the 3.75 mA point on the rising edge of the input pulse to the 1.5 V point on the falling edge of the output pulse.
5. The t_{ELH} enable propagation delay is measured from the 1.5 V point on the falling edge of the enable input pulse to the 1.5 V point on the rising edge of the output pulse.
6. The t_{EHL} enable propagation delay is measured from the 1.5 V point on the rising edge of the enable input pulse to the 1.5 V point on the falling edge of the output pulse.
7. CM_H is the maximum tolerable rate of rise of the common mode voltage to assure that the output will remain in a high logic state (i.e., $V_O > 2.0 V$).
8. CM_L is the maximum tolerable rate of fall of the common mode voltage to assure that the output will remain in a low logic state (i.e., $V_O < 0.8 V$).
9. Device is considered a two-terminal device: pins 1, 2, 3 and 4 shorted together, and pins 5, 6, 7 and 8 shorted together.
10. In accordance with UL1577, each optocoupler is proof tested by applying an insulation test voltage 5250Vrms for one second (leakage current less than 10 μA). This test is performed before the 100% production test for partial discharge

PHOTOCOUPLER 6N137 series

6. SWITCHING TIME TEST CIRCUIT

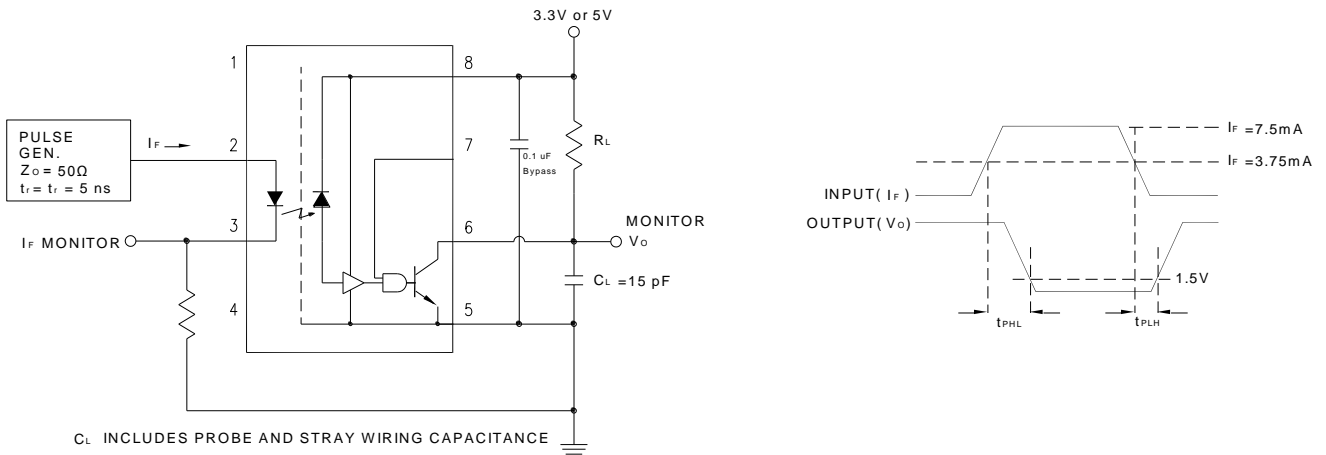

Figure 1: Test Circuit for t_{PHL} and t_{PLH}

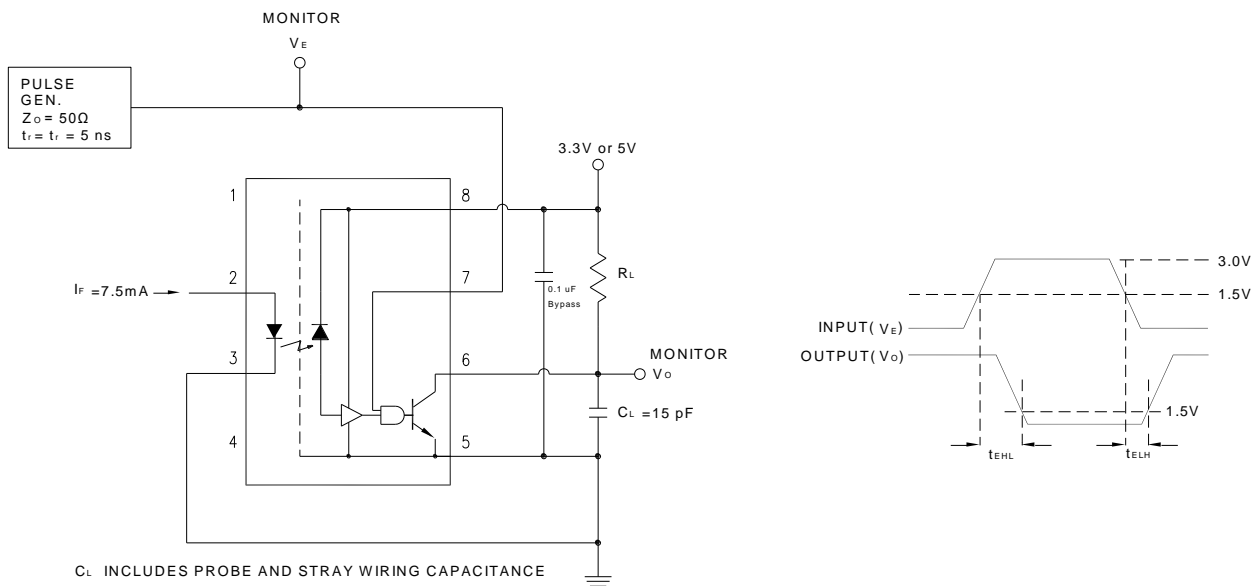

Figure 2: Single Channel Test Circuit for Common Mode Transient Immunity

**PHOTOCOUPLER
6N137 series**



Figure 3: Single Channel Test Circuit for Common Mode Transient Immunity

PHOTOCOUPLER 6N137 series

7. CHARACTERISTIC CURVES



Figure 4: Typical High Level Output Current vs. Ambient Temperature

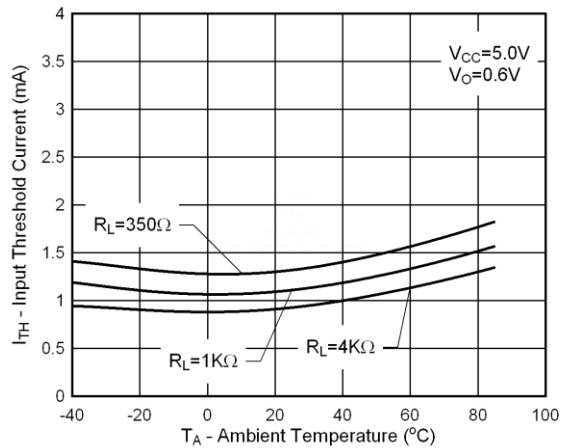

Figure 5: Typical Input Diode Threshold Current vs. Ambient Temperature

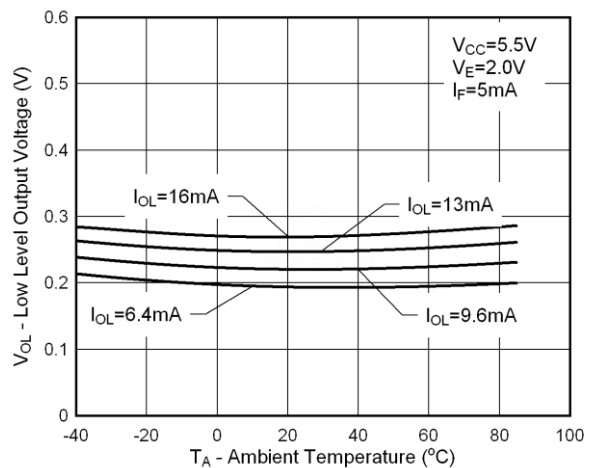
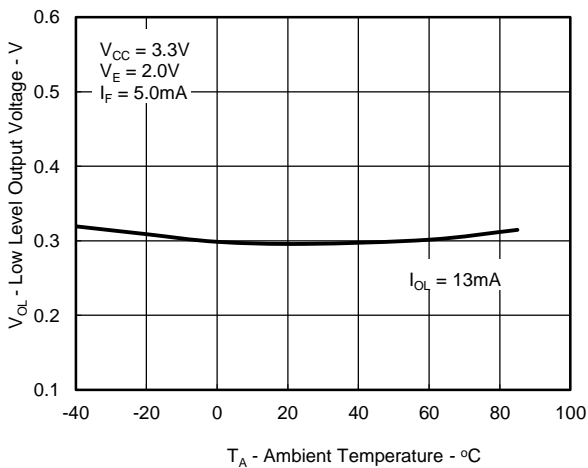

Figure 6: Typical Low Level Output Voltage vs. Ambient Temperature

PHOTOCOUPLER 6N137 series



Figure 7: Typical Low Level Output Current vs. temperature



Figure 8: Typical Input Diode Forward Characteristic

PHOTOCOUPLER 6N137 series

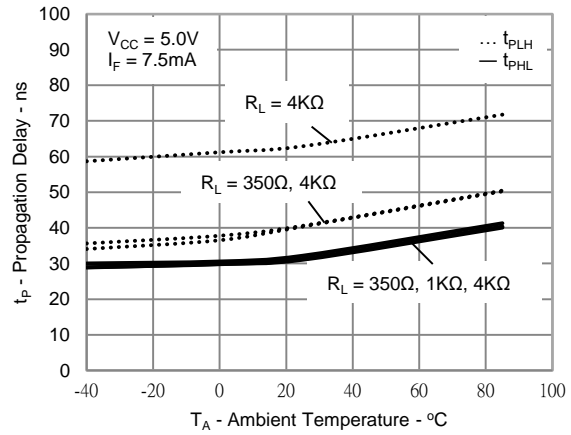

Figure 9: Typical Propagation Delay vs. Ambient Temperature

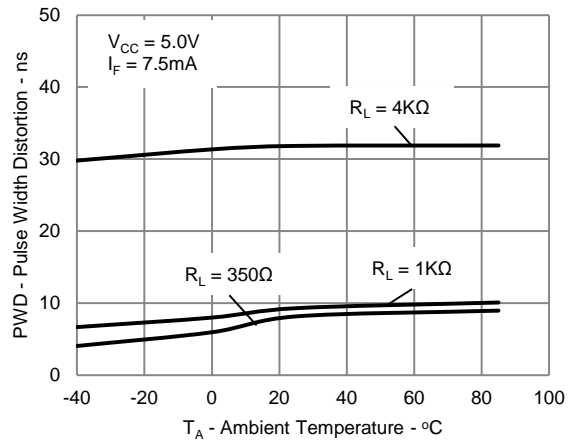

Figure 10: Typical Pulse Width Distortion vs. Ambient Temperature

PHOTOCOUPLER 6N137 series

8. TEMPERATURE PROFILE OF SOLDERING

8.1 IR Reflow soldering (JEDEC-STD-020C compliant)

One time soldering reflow is recommended within the condition of temperature and time profile shown below. Do not solder more than three times.

Profile item	Conditions
Preheat	
- Temperature Min (T_{Smin})	150°C
- Temperature Max (T_{Smax})	200°C
- Time (min to max) (t_s)	90±30 sec
Soldering zone	
- Temperature (T_L)	217°C
- Time (t_L)	60 ~ 100 sec
Peak Temperature (T_P)	260°C
Ramp-up rate	3°C / sec max.
Ramp-down rate	3~6°C / sec

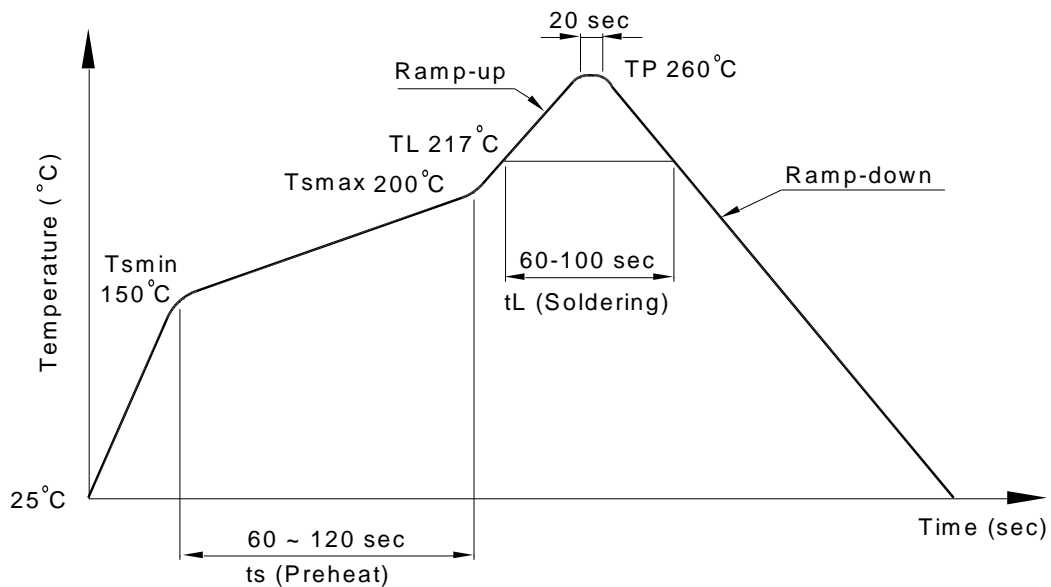

PHOTOCOUPLER 6N137 series

8.2 Wave soldering (JEDEC22A111 compliant)

One time soldering is recommended within the condition of temperature.

Temperature: $260 \pm 0 / -5^{\circ}\text{C}$

Time: 10 sec.

Preheat temperature: 25 to 140°C

Preheat time: 30 to 80 sec.

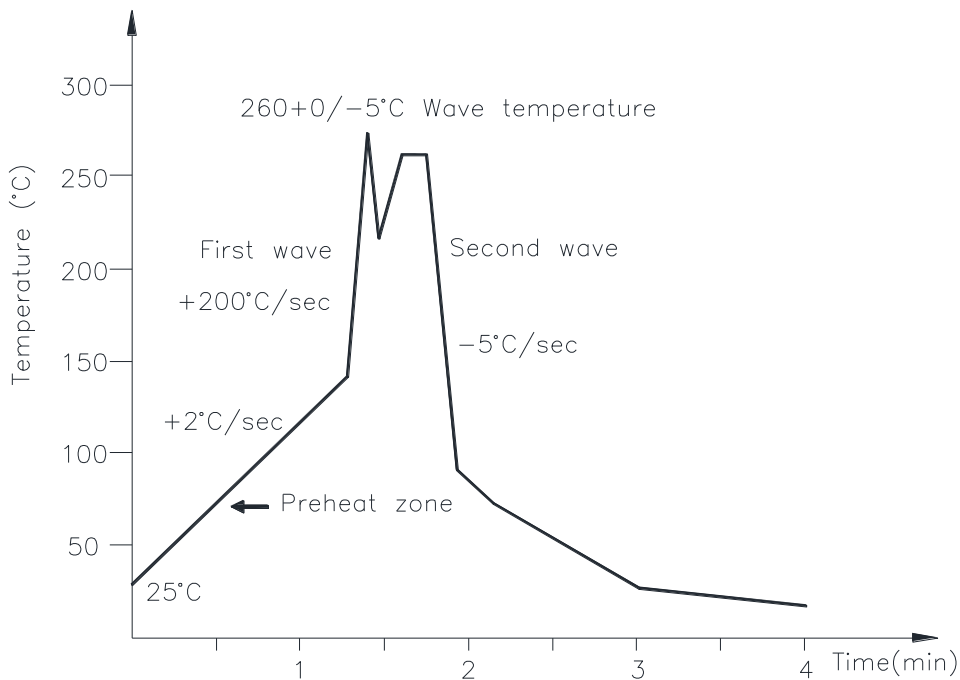

8.3 Hand soldering by soldering iron

Allow single lead soldering in every single process. One time soldering is recommended.

Temperature: $380 \pm 0 / -5^{\circ}\text{C}$

Time: 3 sec max.

9. Notes:

Specifications of the products displayed herein are subject to change without notice.

The products shown in this publication are designed for the general use in electronic applications such as office automation equipment, communications devices, audio/visual equipment, electrical instrumentation and application. For equipment/devices where high reliability or safety is required, such as space applications, nuclear power control equipment, medical equipment, etc, please contact our sales representatives.

Mouser Electronics

Authorized Distributor

Click to View Pricing, Inventory, Delivery & Lifecycle Information:

[Lite-On:](#)

[6N137S-TA1](#) [6N137S](#) [6N137](#) [6N137M](#)



Компания «ЭлектроПласт» предлагает заключение долгосрочных отношений при поставках импортных электронных компонентов на взаимовыгодных условиях!

Наши преимущества:

- Оперативные поставки широкого спектра электронных компонентов отечественного и импортного производства напрямую от производителей и с крупнейших мировых складов;
- Поставка более 17-ти миллионов наименований электронных компонентов;
- Поставка сложных, дефицитных, либо снятых с производства позиций;
- Оперативные сроки поставки под заказ (от 5 рабочих дней);
- Экспресс доставка в любую точку России;
- Техническая поддержка проекта, помощь в подборе аналогов, поставка прототипов;
- Система менеджмента качества сертифицирована по Международному стандарту ISO 9001;
- Лицензия ФСБ на осуществление работ с использованием сведений, составляющих государственную тайну;
- Поставка специализированных компонентов (Xilinx, Altera, Analog Devices, Intersil, Interpoint, Microsemi, Aeroflex, Peregrine, Syfer, Eurofarad, Texas Instrument, Miteq, Cobham, E2V, MA-COM, Hittite, Mini-Circuits, General Dynamics и др.);

Помимо этого, одним из направлений компании «ЭлектроПласт» является направление «Источники питания». Мы предлагаем Вам помощь Конструкторского отдела:

- Подбор оптимального решения, техническое обоснование при выборе компонента;
- Подбор аналогов;
- Консультации по применению компонента;
- Поставка образцов и прототипов;
- Техническая поддержка проекта;
- Защита от снятия компонента с производства.



Как с нами связаться

Телефон: 8 (812) 309 58 32 (многоканальный)

Факс: 8 (812) 320-02-42

Электронная почта: org@eplast1.ru

Адрес: 198099, г. Санкт-Петербург, ул. Калинина, дом 2, корпус 4, литера А.