



Surface Mount TRANSZORB® Transient Voltage Suppressors



DO-215AB (SMCG)

| PRIMARY CHARACTERISTICS | |
|---|----------------|
| V _{WM} | 5.0 V to 188 V |
| P _{PPM} | 1500 W |
| P _D | 6.5 W |
| I _{FSM} (uni-directional only) | 200 A |
| T _J max. | 150 °C |

DEVICES FOR BI-DIRECTION APPLICATIONS

For bi-directional devices use CA suffix (e.g. SMCG188CA).

Electrical characteristics apply in both directions.

FEATURES

- Low profile package
- Ideal for automated placement
- Glass passivated chip junction
- Available in uni-directional and bi-directional
- Excellent clamping capability
- Very fast response time
- Low incremental surge resistance
- Meets MSL level 1, per J-STD-020, LF maximum peak of 260 °C
- AEC-Q101 qualified
- Material categorization: For definitions of compliance please see www.vishay.com/doc?99912



RoHS COMPLIANT

TYPICAL APPLICATIONS

Use in sensitive electronics protection against voltage transients induced by inductive load switching and lighting on ICs, MOSFET, signal lines of sensor units for consumer, computer, industrial, automotive, and telecommunication.

MECHANICAL DATA

Case: DO-215AB (SMCG)

Molding compound meets UL 94 V-0 flammability rating
Base P/N-E3 - RoHS compliant, commercial grade
Base P/NHE3 - RoHS compliant, AEC-Q101 qualified

Terminals: Matte tin plated leads, solderable per J-STD-002 and JESD 22-B102

E3 suffix meets JESD 201 class 1A whisker test, HE3 suffix meets JESD 201 class 2 whisker test

Polarity: For uni-directional types the band denotes cathode end, no marking on bi-directional types

| MAXIMUM RATINGS (T _A = 25 °C unless otherwise noted) | | | |
|---|-----------------------------------|----------------|------|
| PARAMETER | SYMBOL | VALUE | UNIT |
| Peak pulse power dissipation with a 10/1000 μs waveform ⁽¹⁾⁽²⁾ | P _{PPM} | 1500 | W |
| Peak pulse current with a 10/1000 μs waveform ⁽¹⁾ | I _{PPM} | See next table | A |
| Peak forward surge current 8.3 ms single half sine-wave uni-directional only ⁽²⁾ | I _{FSM} | 200 | A |
| Power dissipation on infinite heatsink, T _A = 50 °C | P _D | 6.5 | W |
| Operating junction and storage temperature range | T _J , T _{STG} | - 55 to + 150 | °C |

Notes

⁽¹⁾ Non-repetitive current pulse, per fig. 3 and derated above T_A = 25 °C per fig. 2.

⁽²⁾ Mounted on 0.31" x 0.31" (8.0 mm x 8.0 mm) copper pads to each terminal



| ELECTRICAL CHARACTERISTICS (T _A = 25 °C unless otherwise noted) | | | | | | | | | |
|--|------------------------|-----|---|------|---|--|---|--|---|
| DEVICE TYPE MODIFIED GULL WING | DEVICE MARKING CODE | | BREAKDOWN VOLTAGE V _{BR} AT I _T ⁽¹⁾ (V) | | TEST CURRENT I _T (mA) | STAND-OFF VOLTAGE V _{WM} (V) | MAXIMUM REVERSE LEAKAGE AT V _{WM} I _D (µA) ⁽³⁾ | MAXIMUM PEAK PULSE SURGE CURRENT I _{PPM} (A) ⁽²⁾ | MAXIMUM CLAMPING VOLTAGE AT I _{PPM} V _C (V) |
| | UNI | BI | MIN. | MAX. | | | | | |
| (+)SMCG5.0A ⁽⁵⁾ | GDE | GDE | 6.40 | 7.07 | 10 | 5.0 | 1000 | 163.0 | 9.20 |
| (+)SMCG6.0A | GDG | GDG | 6.67 | 7.37 | 10 | 6.0 | 1000 | 145.6 | 10.3 |
| (+)SMCG6.5A | GDK | BDK | 7.22 | 7.98 | 10 | 6.5 | 500 | 133.9 | 11.2 |
| (+)SMCG7.0A | GDM | GDM | 7.78 | 8.60 | 10 | 7.0 | 200 | 125.0 | 12.0 |
| (+)SMCG7.5A | GDP | BDP | 8.33 | 9.21 | 1.0 | 7.5 | 100 | 116.3 | 12.9 |
| (+)SMCG8.0A | GDR | BDR | 8.89 | 9.83 | 1.0 | 8.0 | 50 | 110.3 | 13.6 |
| (+)SMCG8.5A | GDT | BDT | 9.44 | 10.4 | 1.0 | 8.5 | 20 | 104.2 | 14.4 |
| (+)SMCG9.0A | GDV | BDV | 10.0 | 11.1 | 1.0 | 9.0 | 10 | 97.4 | 15.4 |
| (+)SMCG10A | GDY | BDY | 11.1 | 12.3 | 1.0 | 10 | 5.0 | 88.2 | 17.0 |
| (+)SMCG11A | GDZ | GDZ | 12.2 | 13.5 | 1.0 | 11 | 5.0 | 82.4 | 18.2 |
| (+)SMCG12A | GEE | BEE | 13.3 | 14.7 | 1.0 | 12 | 5.0 | 75.4 | 19.9 |
| (+)SMCG13A | GEG | GEG | 14.4 | 15.9 | 1.0 | 13 | 1.0 | 69.8 | 21.5 |
| (+)SMCG14A | GEK | BEK | 15.6 | 17.2 | 1.0 | 14 | 1.0 | 64.7 | 23.2 |
| (+)SMCG15A | GEM | BEM | 16.7 | 18.5 | 1.0 | 15 | 1.0 | 61.5 | 24.4 |
| (+)SMCG16A | GEP | GEP | 17.8 | 19.7 | 1.0 | 16 | 1.0 | 57.7 | 26.0 |
| (+)SMCG17A | GER | GER | 18.9 | 20.9 | 1.0 | 17 | 1.0 | 54.3 | 27.6 |
| (+)SMCG18A | GET | BET | 20.0 | 22.1 | 1.0 | 18 | 1.0 | 51.4 | 29.2 |
| (+)SMCG20A | GEV | BEV | 22.2 | 24.5 | 1.0 | 20 | 1.0 | 46.3 | 32.4 |
| (+)SMCG22A | GEX | BEX | 24.4 | 26.9 | 1.0 | 22 | 1.0 | 42.3 | 35.5 |
| (+)SMCG24A | GEZ | BEZ | 26.7 | 29.5 | 1.0 | 24 | 1.0 | 38.6 | 38.9 |
| (+)SMCG26A | GFE | BFE | 28.9 | 31.9 | 1.0 | 26 | 1.0 | 35.6 | 42.1 |
| (+)SMCG28A | GFG | BFG | 31.1 | 34.4 | 1.0 | 28 | 1.0 | 33.0 | 45.4 |
| (+)SMCG30A | GFK | BFK | 33.3 | 36.8 | 1.0 | 30 | 1.0 | 31.0 | 48.4 |
| (+)SMCG33A | GFM | BFM | 36.7 | 40.6 | 1.0 | 33 | 1.0 | 28.1 | 53.3 |
| (+)SMCG36A | GFP | BFP | 40.0 | 44.2 | 1.0 | 36 | 1.0 | 25.8 | 58.1 |
| (+)SMCG40A | GFR | BFR | 44.4 | 49.1 | 1.0 | 40 | 1.0 | 23.3 | 64.5 |
| (+)SMCG43A | GFT | BFT | 47.8 | 52.8 | 1.0 | 43 | 1.0 | 21.6 | 69.4 |
| (+)SMCG45A | GFV | GFV | 50.0 | 55.3 | 1.0 | 45 | 1.0 | 20.6 | 72.7 |
| (+)SMCG48A | GFX | GFX | 53.3 | 58.9 | 1.0 | 48 | 1.0 | 19.4 | 77.4 |
| (+)SMCG51A | GFZ | GFZ | 56.7 | 62.7 | 1.0 | 51 | 1.0 | 18.2 | 82.4 |
| (+)SMCG54A | GGE | GGE | 60.0 | 66.3 | 1.0 | 54 | 1.0 | 17.2 | 87.1 |
| (+)SMCG58A | GGG | GGG | 64.4 | 71.2 | 1.0 | 58 | 1.0 | 16.0 | 93 |
| (+)SMCG60A | GGK | GGK | 66.7 | 73.7 | 1.0 | 60 | 1.0 | 15.5 | 96 |
| (+)SMCG64A | GGM | GGM | 71.1 | 78.6 | 1.0 | 64 | 1.0 | 14.6 | 103 |
| (+)SMCG70A | GGP | GGP | 77.8 | 86.0 | 1.0 | 70 | 1.0 | 13.3 | 113 |
| (+)SMCG75A | GGR | GGR | 83.3 | 92.1 | 1.0 | 75 | 1.0 | 12.4 | 121 |
| (+)SMCG78A | GGT | GGT | 86.7 | 95.8 | 1.0 | 78 | 1.0 | 11.9 | 126 |
| (+)SMCG85A | GGV | GGV | 94.4 | 104 | 1.0 | 85 | 1.0 | 10.9 | 137 |
| (+)SMCG90A | GGX | GGX | 100 | 111 | 1.0 | 90 | 1.0 | 10.3 | 146 |
| (+)SMCG100A | GGZ | GGZ | 111 | 123 | 1.0 | 100 | 1.0 | 9.3 | 162 |
| (+)SMCG110A | GHE | GHE | 122 | 135 | 1.0 | 110 | 1.0 | 8.5 | 177 |
| (+)SMCG120A | GHG | GHG | 133 | 147 | 1.0 | 120 | 1.0 | 7.8 | 193 |
| (+)SMCG130A | GHK | GHK | 144 | 159 | 1.0 | 130 | 1.0 | 7.2 | 209 |
| (+)SMCG150A | GHM | GHM | 167 | 185 | 1.0 | 150 | 1.0 | 6.2 | 243 |
| (+)SMCG160A | GHP | GHP | 178 | 197 | 1.0 | 160 | 1.0 | 5.8 | 259 |
| (+)SMCG170A | GHR | GHR | 189 | 209 | 1.0 | 170 | 1.0 | 5.5 | 275 |
| SMCG188A | GHS | GHS | 209 | 231 | 1.0 | 188 | 1.0 | 4.6 | 328 |

Notes

- (1) Pulse test: t_p ≤ 50 ms
- (2) Surge current waveform per fig. 3 and derate per fig. 2
- (3) For bi-directional types having V_{WM} of 10 V and less, the I_D limit is doubled
- (4) All terms and symbols are consistent with ANSI/IEEE C62.35
- (5) For the bi-directional SMCG5.0CA, the maximum V_{BR} is 7.25 V
- (6) V_F = 3.5 V at I_F = 100 A (uni-directional only)
- (*) Underwriters laboratory recognition for the classification of protectors (QVGQ2) under the UL standard for safety 497B and file number E136766 for both uni-directional and bi-directional devices

| THERMAL CHARACTERISTICS ($T_A = 25\text{ }^\circ\text{C}$ unless otherwise noted) | | | |
|---|-----------------|-------|------|
| PARAMETER | SYMBOL | VALUE | UNIT |
| Typical thermal resistance, junction to ambient ⁽¹⁾ | $R_{\theta JA}$ | 75 | °C/W |
| Typical thermal resistance, junction to lead | $R_{\theta JL}$ | 15 | |

Note

⁽¹⁾ Measured on minimum recommended pad layout

| ORDERING INFORMATION (Example) | | | | |
|---------------------------------------|-----------------|------------------------|---------------|------------------------------------|
| PREFERRED P/N | UNIT WEIGHT (g) | PREFERRED PACKAGE CODE | BASE QUANTITY | DELIVERY MODE |
| SMCG5.0A-E3/57T | 0.211 | 57T | 850 | 7" diameter plastic tape and reel |
| SMCG5.0A-E3/9AT | 0.211 | 9AT | 3500 | 13" diameter plastic tape and reel |
| SMCG5.0AHE3/57T ⁽¹⁾ | 0.211 | 57T | 850 | 7" diameter plastic tape and reel |
| SMCG5.0AHE3/9AT ⁽¹⁾ | 0.211 | 9AT | 3500 | 13" diameter plastic tape and reel |

Note

⁽¹⁾ AEC-Q101 qualified

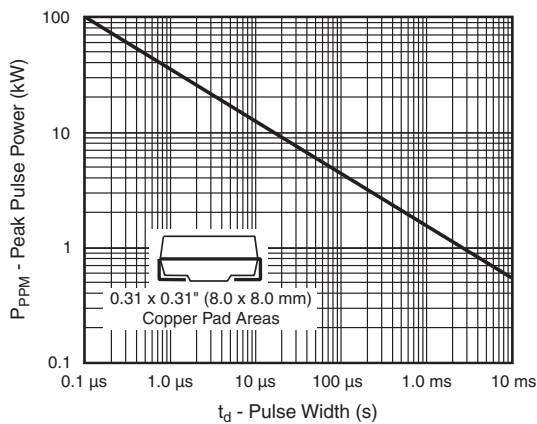
RATINGS AND CHARACTERISTICS CURVES ($T_A = 25\text{ }^\circ\text{C}$ unless otherwise noted)


Fig. 1 - Peak Pulse Power Rating Curve

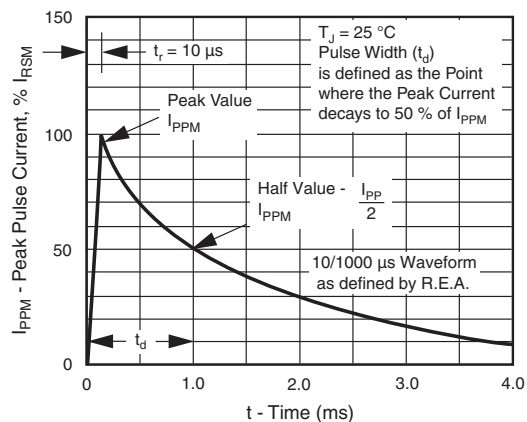


Fig. 3 - Pulse Waveform

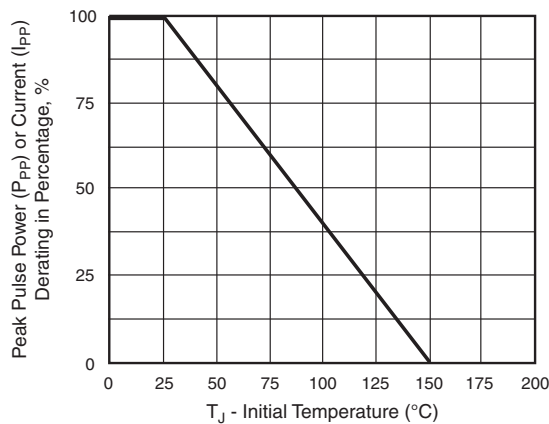


Fig. 2 - Pulse Power or Current vs. Initial Junction Temperature

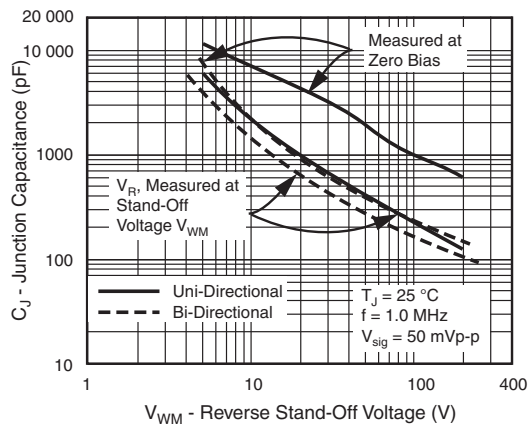


Fig. 4 - Typical Junction Capacitance Uni-Directional

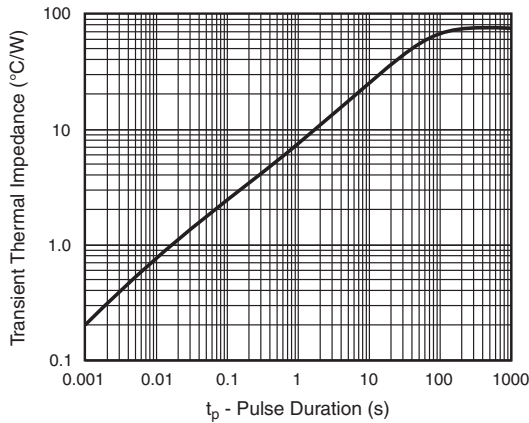


Fig. 5 - Typical Transient Thermal Impedance

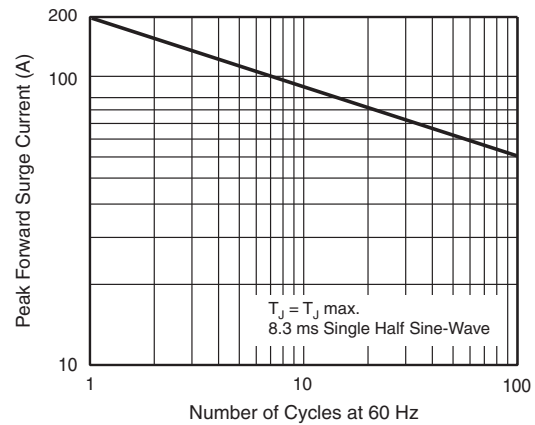
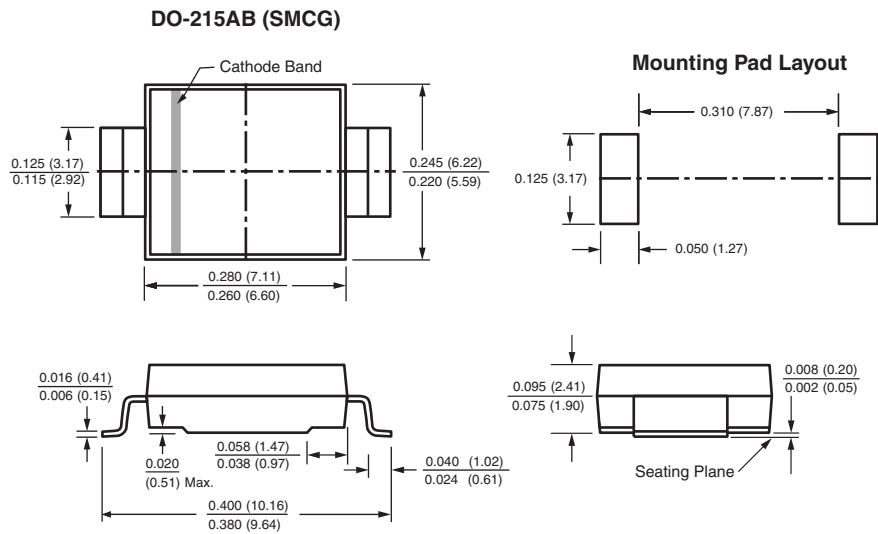


Fig. 6 - Maximum Non-Repetitive Peak Forward Surge Current
Uni-Directional Use Only

PACKAGE OUTLINE DIMENSIONS in inches (millimeters)





Disclaimer

ALL PRODUCT, PRODUCT SPECIFICATIONS AND DATA ARE SUBJECT TO CHANGE WITHOUT NOTICE TO IMPROVE RELIABILITY, FUNCTION OR DESIGN OR OTHERWISE.

Vishay Intertechnology, Inc., its affiliates, agents, and employees, and all persons acting on its or their behalf (collectively, "Vishay"), disclaim any and all liability for any errors, inaccuracies or incompleteness contained in any datasheet or in any other disclosure relating to any product.

Vishay makes no warranty, representation or guarantee regarding the suitability of the products for any particular purpose or the continuing production of any product. To the maximum extent permitted by applicable law, Vishay disclaims (i) any and all liability arising out of the application or use of any product, (ii) any and all liability, including without limitation special, consequential or incidental damages, and (iii) any and all implied warranties, including warranties of fitness for particular purpose, non-infringement and merchantability.

Statements regarding the suitability of products for certain types of applications are based on Vishay's knowledge of typical requirements that are often placed on Vishay products in generic applications. Such statements are not binding statements about the suitability of products for a particular application. It is the customer's responsibility to validate that a particular product with the properties described in the product specification is suitable for use in a particular application. Parameters provided in datasheets and/or specifications may vary in different applications and performance may vary over time. All operating parameters, including typical parameters, must be validated for each customer application by the customer's technical experts. Product specifications do not expand or otherwise modify Vishay's terms and conditions of purchase, including but not limited to the warranty expressed therein.

Except as expressly indicated in writing, Vishay products are not designed for use in medical, life-saving, or life-sustaining applications or for any other application in which the failure of the Vishay product could result in personal injury or death. Customers using or selling Vishay products not expressly indicated for use in such applications do so at their own risk and agree to fully indemnify and hold Vishay and its distributors harmless from and against any and all claims, liabilities, expenses and damages arising or resulting in connection with such use or sale, including attorneys fees, even if such claim alleges that Vishay or its distributor was negligent regarding the design or manufacture of the part. Please contact authorized Vishay personnel to obtain written terms and conditions regarding products designed for such applications.

No license, express or implied, by estoppel or otherwise, to any intellectual property rights is granted by this document or by any conduct of Vishay. Product names and markings noted herein may be trademarks of their respective owners.

Material Category Policy

Vishay Intertechnology, Inc. hereby certifies that all its products that are identified as RoHS-Compliant fulfill the definitions and restrictions defined under Directive 2011/65/EU of The European Parliament and of the Council of June 8, 2011 on the restriction of the use of certain hazardous substances in electrical and electronic equipment (EEE) - recast, unless otherwise specified as non-compliant.

Please note that some Vishay documentation may still make reference to RoHS Directive 2002/95/EC. We confirm that all the products identified as being compliant to Directive 2002/95/EC conform to Directive 2011/65/EU.



Компания «ЭлектроПласт» предлагает заключение долгосрочных отношений при поставках импортных электронных компонентов на взаимовыгодных условиях!

Наши преимущества:

- Оперативные поставки широкого спектра электронных компонентов отечественного и импортного производства напрямую от производителей и с крупнейших мировых складов;
- Поставка более 17-ти миллионов наименований электронных компонентов;
- Поставка сложных, дефицитных, либо снятых с производства позиций;
- Оперативные сроки поставки под заказ (от 5 рабочих дней);
- Экспресс доставка в любую точку России;
- Техническая поддержка проекта, помощь в подборе аналогов, поставка прототипов;
- Система менеджмента качества сертифицирована по Международному стандарту ISO 9001;
- Лицензия ФСБ на осуществление работ с использованием сведений, составляющих государственную тайну;
- Поставка специализированных компонентов (Xilinx, Altera, Analog Devices, Intersil, Interpoint, Microsemi, Aeroflex, Peregrine, Syfer, Eurofarad, Texas Instrument, Miteq, Cobham, E2V, MA-COM, Hittite, Mini-Circuits, General Dynamics и др.);

Помимо этого, одним из направлений компании «ЭлектроПласт» является направление «Источники питания». Мы предлагаем Вам помощь Конструкторского отдела:

- Подбор оптимального решения, техническое обоснование при выборе компонента;
- Подбор аналогов;
- Консультации по применению компонента;
- Поставка образцов и прототипов;
- Техническая поддержка проекта;
- Защита от снятия компонента с производства.



Как с нами связаться

Телефон: 8 (812) 309 58 32 (многоканальный)

Факс: 8 (812) 320-02-42

Электронная почта: org@eplast1.ru

Адрес: 198099, г. Санкт-Петербург, ул. Калинина, дом 2, корпус 4, литера А.