

VF4A (Standard, Shrouded and Weatherproof)

- Pin assignment similar to ISO 7588 part 1
- Plug-in terminals
- Customized versions on request
 - Integrated components (e.g. resistor, diode)
 - Customized marking
 - Special covers (e.g. brackets, shrouded)

Typical applications

Cross carline up to 40A for example: ABS control, blower fans, car alarm, cooling fan, Electric Power Steering, energy management, engine control, fuel pump, heated front screen, lamps: front, rear, fog light, main switch/supply relay, valves, wiper control.

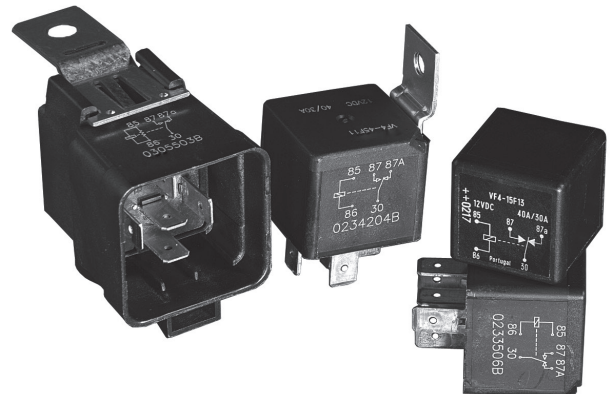

FVF4Aco_fcw1_bw

Contact Data	
Contact arrangement	1 form C, 1 CO
Rated voltage	12VDC
Limiting continuous current, form A/form B	NO/NC
23°C	60/45A
85°C	40/30A
125°C	17/12A
Limiting making current ¹⁾ , form A/form B	120/45A
Limiting breaking current, form A/form B	60/40A
Limiting short-time current overload current, ISO 8820-3 ²⁾	1.35 x 40A, 1800s 2.00 x 40A, 60s 6.00 x 40A, 1s
Jump start test, ISO 16750-1	24VDC for 5min, conducting nominal current at 23°C
Contact material	silver based
Min. recommended contact load ³⁾	1A at 5VDC
Initial voltage drop, form A (NO) contact at 40A, typ./max.	60/200mV
form B (NC) contact at 30A, typ./max.	60/250mV
Frequency of operation at nominal load	6 ops./min (0.1Hz)
Operate/release time typ.	7/2ms ⁴⁾
Electrical endurance, resistive load, form A (NO) contact	>1x10 ⁵ ops. 40A, 14VDC
resistive load, form B (NC) contact	30A, 14VDC

Contact Data (continued)	
Mechanical endurance	>1x10 ⁶ ops.

- 1) The values apply to a resistive or inductive load with suitable spark suppression and at maximum 14VDC for 12VDC or 28VDC for 24VDC load voltages. For a load current duration of maximum 3s for a make/break ratio of 1:10.
- 2) Current and time are compatible with circuit protection by a typical automotive fuse. Relay will make, carry and break the specified current.
- 3) See chapter Diagnostics of Relays in our Application Notes or consult the internet at <http://relays.te.com/appnotes/>
- 4) For unsuppressed relay coil. A low resistive suppression device in parallel to the relay coil increases the release time and reduces the lifetime caused by increased erosion and/or higher risk of contact tack welding.

Coil Data					
Rated coil voltage	12/24VDC				
Coil versions, DC coil					
Coil code	Rated voltage VDC	Operate voltage VDC	Release voltage VDC	Coil resistance ⁵⁾ Ω±10%	Rated coil power ⁵⁾ W
F	12	7.2	1.2	90	1.6
H	24	14.4	2.4	360	1.6

5) Without components in parallel.
All figures are given for coil without pre-energization, at ambient temperature +23°C.

Max. DC load breaking capacity

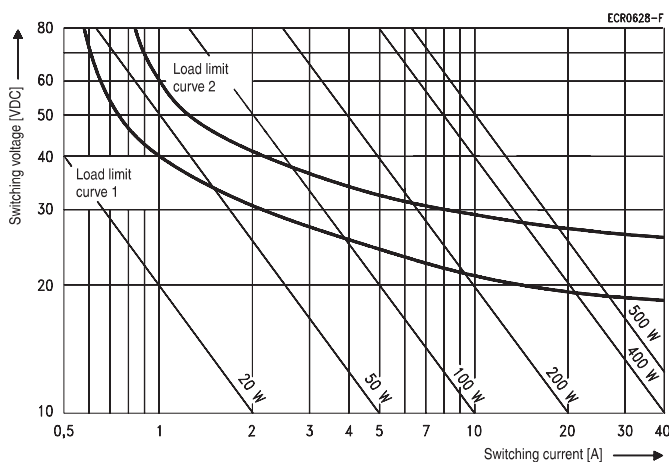

Load limit curve 1: arc extinguishes during transit time (changeover contact).
Load limit curve 2: safe shutdown, no stationary arc (make contact).
Load limit curves measured with low inductive resistors verified for 1000 switching events.

Coil operating range

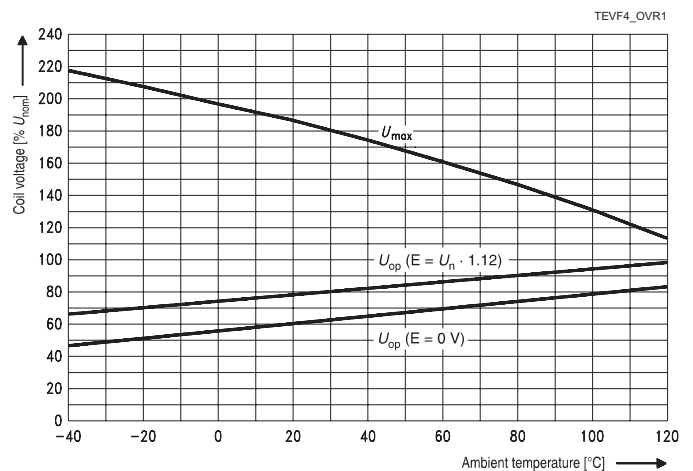

Does not take into account the temperature rise due to the contact current
E = pre-energization.

VF4A (Standard, Shrouded and Weatherproof) (Continued)

Insulation Data

Initial dielectric strength	
between open contacts	500V _{rms}
between contact and coil	500V _{rms}
between adjacent contacts	500V _{rms}

Other Data

EU RoHS/ELV compliance	compliant
Protection to heat and fire according UL94	UL94-HB or better
Ambient temperature	-40 to 125°C
Category of environmental protection, IEC 61810	RT I (dustproof), RT III (sealed/sealed – shrouded)
Degree of protection, IEC 60529	IP54 (dustproof), IP67 (sealed) IP67 (sealed – shrouded), only with special connector
Vibration resistance (functional) IEC 60068-2-6 (sine sweep)	10 to 500Hz, min. 5g ⁶⁾
Shock resistance (functional) IEC 60068-2-27 (half sine)	11ms, min. 20g ⁶⁾
Drop test, free fall, IEC 60068-2-32	1m onto concrete

Other Data (continued)

Terminal type	plug-in, QC
Cover retention	
axial force	150N
pull force	200N
push force	200N
Terminal retention	
pull force	100N
push force	100N
resistance to bending	10N ⁷⁾
force applied to side	10N ⁷⁾
torque	0.3Nm
Weight	approx. 35 to 60g (1.2 to 2.1oz)
Packaging unit	
cover type VF4-1	357 pcs.
VF4-4	200 pcs.
VF4-5, VF4-6	110 pcs.

6) No change in the switching state > 1ms. Valid for NC contacts, NO contact values significantly higher.

7) Values apply 2mm from the end of the terminal. When the force is removed, the terminal must not have moved by more than 0.3mm.

Accessories

For details see datasheet Connectors for Mini,
Mini (Shrouded) and Maxi ISO Relays

Terminal Assignment

CO
1 form C, 1 CO

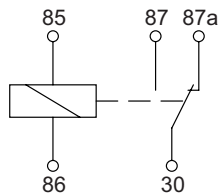

COD
1 form C, 1 CO with diode

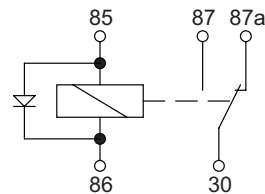

COR
1 form C, 1 CO with resistor

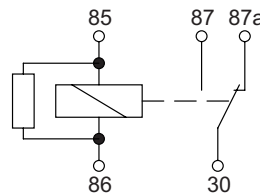

Dimensions

VF4A with dust cover
VF4-1**** (without bracket) and VF4-4**** (with bracket)

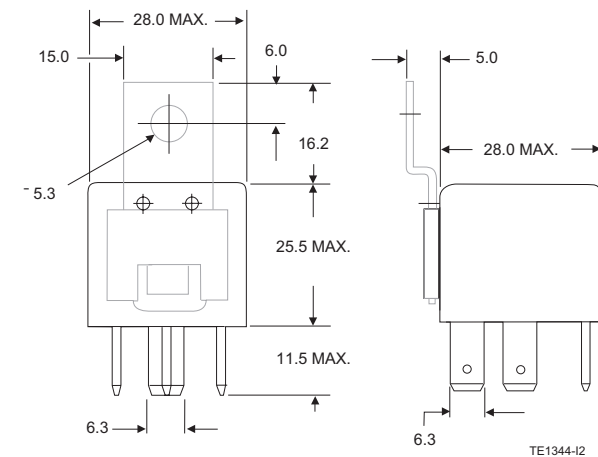

View of the terminals (bottom view)

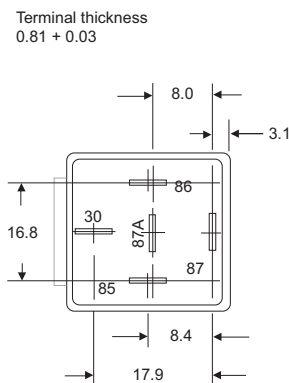

VF4A (Standard, Shrouded and Weatherproof) (Continued)

Dimensions

VF4A with shrouded dust cover
VF4-2**** (without bracket) and VF4-5**** (with bracket)

View of the terminals (bottom view)

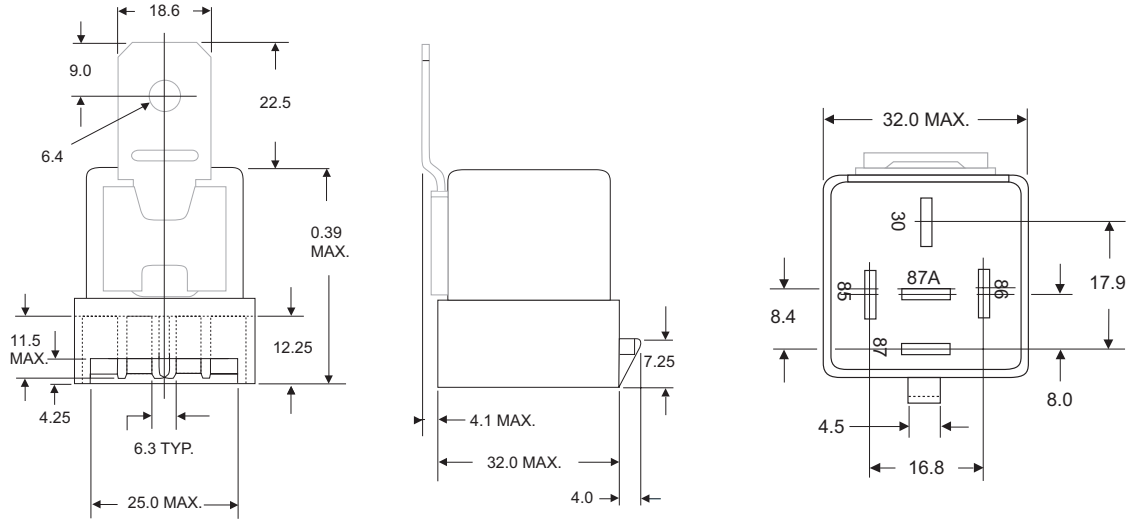

TE1347-82

VF4A with weatherproof cover
VF4-3**** (without bracket) and VF4-6**** (with bracket)

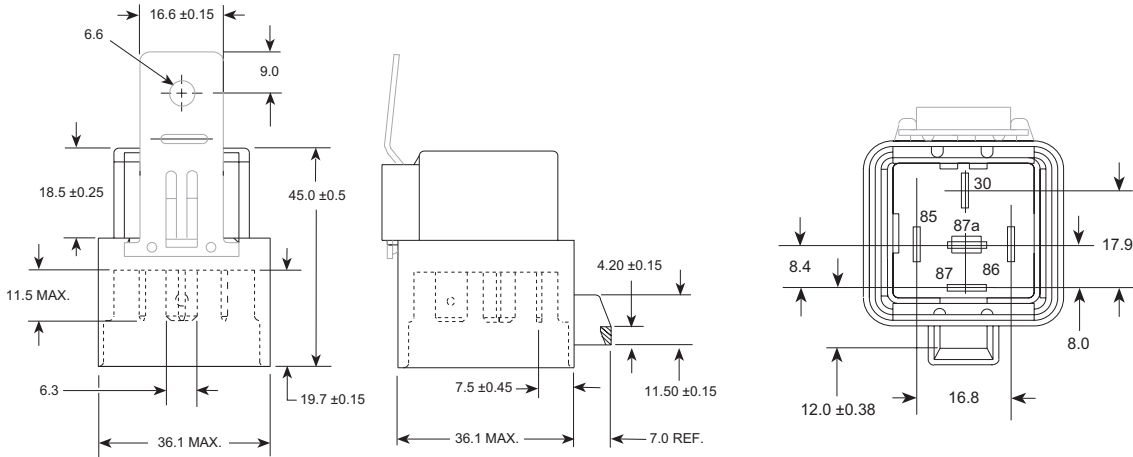

TE1348-91

VF4A (Standard, Shrouded and Weatherproof) (Continued)

Product code structure		Typical product code		VF4	-1	5	F	11	-S01
Type		VF4A							
Cover type		1 Dust cover standard		2 Shrouded dust cover standard					
3 Weatherproof cover standard		4 Dust cover with bracket							
5 Shrouded dust cover with bracket		6 Weatherproof cover with bracket							
Contact arrangement		5 1 form C, 1 CO							
Coil		F 12VDC		H 24VDC					
Contact material		11 Silver based		21 Silver based for capacitive loads					
Coil suppression		S01 Resistor in parallel (680Ω)		S05 Diode in parallel (cathode 86)					
S08 Resistor in parallel (2700Ω)									

Product code	Arrangement	Cover	Coil suppr.	Circuit ¹⁾	Coil	Cont. material	Terminals	Part number
VF4A-15F11	1 form C,	Standard		CO	12VDC	Silver based	Plug-in, QC	6-1393298-0
VF4A-15F11-S01	1 CO		Resistor 680Ω	COR				6-1393298-4
VF4A-15F11-S05			Diode (cathode 86)	COD				6-1393298-5
VF4A-15F21-S01			Resistor 680Ω	COR		Silver based ²⁾		7-1393298-3
VF4A-15H11				CO	24VDC	Silver based		8-1393298-1
VF4A-15H11-S08			Resistor 2700Ω	COR				5-1393305-7
VF4A-45F11		Bracket		CO	12VDC			8-1393298-8
VF4A-45F11-S01			Resistor 680Ω	COR				1-1393302-0
VF4A-45H11				CO	24VDC			1-1393302-1
VF4A-55F11-S01		Shrouded	Resistor 680Ω	COR	12VDC			8-1393305-7
VF4A-65F11-S01								9-1393305-5
VF4A-65H11-S08		Weatherproof						
			Resistor 2700Ω			24VDC		

1) See terminal assignment diagrams.

2) Special contact material for capacitive loads.

Other types on request.

This list represents the most common types and does not show all variants covered by this datasheet.



Компания «ЭлектроПласт» предлагает заключение долгосрочных отношений при поставках импортных электронных компонентов на взаимовыгодных условиях!

Наши преимущества:

- Оперативные поставки широкого спектра электронных компонентов отечественного и импортного производства напрямую от производителей и с крупнейших мировых складов;
- Поставка более 17-ти миллионов наименований электронных компонентов;
- Поставка сложных, дефицитных, либо снятых с производства позиций;
- Оперативные сроки поставки под заказ (от 5 рабочих дней);
- Экспресс доставка в любую точку России;
- Техническая поддержка проекта, помощь в подборе аналогов, поставка прототипов;
- Система менеджмента качества сертифицирована по Международному стандарту ISO 9001;
- Лицензия ФСБ на осуществление работ с использованием сведений, составляющих государственную тайну;
- Поставка специализированных компонентов (Xilinx, Altera, Analog Devices, Intersil, Interpoint, Microsemi, Aeroflex, Peregrine, Syfer, Eurofarad, Texas Instrument, Miteq, Cobham, E2V, MA-COM, Hittite, Mini-Circuits, General Dynamics и др.);

Помимо этого, одним из направлений компании «ЭлектроПласт» является направление «Источники питания». Мы предлагаем Вам помощь Конструкторского отдела:

- Подбор оптимального решения, техническое обоснование при выборе компонента;
- Подбор аналогов;
- Консультации по применению компонента;
- Поставка образцов и прототипов;
- Техническая поддержка проекта;
- Защита от снятия компонента с производства.



Как с нами связаться

Телефон: 8 (812) 309 58 32 (многоканальный)

Факс: 8 (812) 320-02-42

Электронная почта: org@eplast1.ru

Адрес: 198099, г. Санкт-Петербург, ул. Калинина, дом 2, корпус 4, литера А.