

**Accessories Interface Plug-in Relay XT**

- For Interface Plug-in Relay XT, pinning 5 mm
- Retainer clip with ejection function
- Easy replacement of relays on a densely packed DIN rail
- No reduction of protection class or creepage/clearance with plastic retainer
- Simple plug-in indicator- and protection modules
- White snap-on marking tags

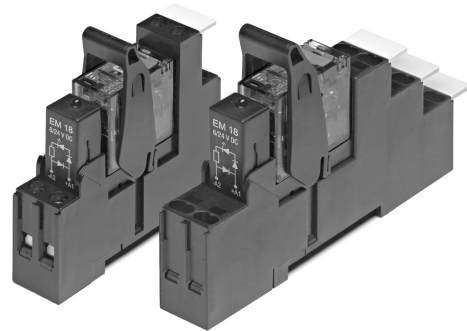

**Premium socket with screwless terminals for DIN rail mounting**

RT 78 72P Premium socket, logical terminal arrangement

- Screwless Clamps
- Mounting of solid wires without tool
- Double Clamps per terminal
- Jumper links for interconnection
- Open coil circuit for active modules
- Logical terminal arrangement

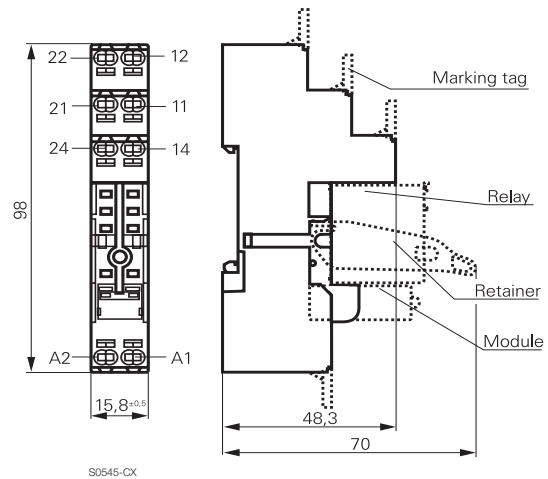
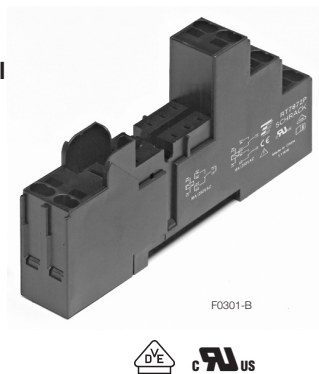

**Approvals**  
VDE Cert. No. 40017832, cULus E135149

Technical data	
Rated voltage/Max. switching voltage AC	240/400 VAC
Rated current	2 x 8 A, 16 A*)
Dielectric strength	
coil contact circuit	5000 V <sub>rms</sub>
open contact circuit	1000 V <sub>rms</sub>
adjacent contact circuits	2500 V <sub>rms</sub>
Clearance / creepage	
coil contact circuit	≥ 8/8 mm
Material group of insulation parts	
IIIa	
Insulation to IEC 60664-1	
Type of insulation coil-contact circuit	reinforced
open contact circuit	functional
adjacent contact circuits	functional
Rated insulation voltage	250 V
Pollution degree	2
Rated voltage system	230 / 400 V
Overvoltage category	III

\*) For 1 pole relays (16 A) the relay terminals 11-21, 12-22 and 14-24 have to be bridged

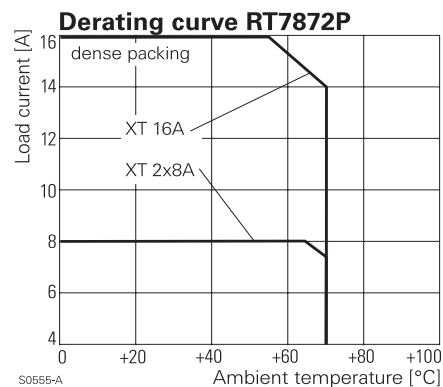

**Accessories Interface Plug-in Relay XT** (Continued)

**Technical data** (continued)

Material compliance: EU RoHS/ELV, China RoHS, REACH, Halogen content refer to the Product Compliance Support Center at [www.te.com/customersupport/rohssupportcenter](http://www.te.com/customersupport/rohssupportcenter)

Ambient temperature range	
for mounting/handling	-20...+70°C
in operation	-40...+70°C
Terminals	screwless
Wire strip length	12 mm
Wire cross section	
solid wire	1x0.75/1/1.5mm <sup>2</sup> 2x0.75/1mm <sup>2</sup> 2x1.5mm <sup>2</sup>
with stand. isolation (no oversize isolation)	
stranded wire	1x0.75/1/1.5mm <sup>2</sup> 2x0.75/1mm <sup>2</sup> 2x1.5mm <sup>2</sup>
without bootlace crimp	
without bootlace crimp with stand. isolation	1x0.75/1mm <sup>2</sup> 2x0.75mm <sup>2</sup>
with bootlace crimp	
with bootlace crimp without isolation	1x1.5mm <sup>2</sup>
or min 18 mm long	

For stranded wires with braids 0.05 mm or smaller the use of bootlace crimps is recommended. When using stranded wires without bootlace crimp, the clamp must be opened during insertion.

Insertion cycles	A (10)
Max. Insertion Force total	100 N
Mounting distance	≥ 0, dense packing
Weight	36 g
Packaging unit	10 pcs

**Socket with screwless terminals for DIN rail mounting**

Type	Part Number
<b>RT 78 72P</b> Premium socket, logical terminal arrangement Socket with screwless terminals pinning 5 mm for DIN rail mounting	1860200-1

**Accessories for RT 78 72P**

Type	Part Number
<b>XT 17 017</b> Plastic retaining clip, relay height 25.5 mm	2022104-1
<b>RT 17 040</b> Marking tag	2-1415038-1
<b>RT 17 0P1</b> Jumper link, max load 12 A	1860211-1

**How to use, Precautions**

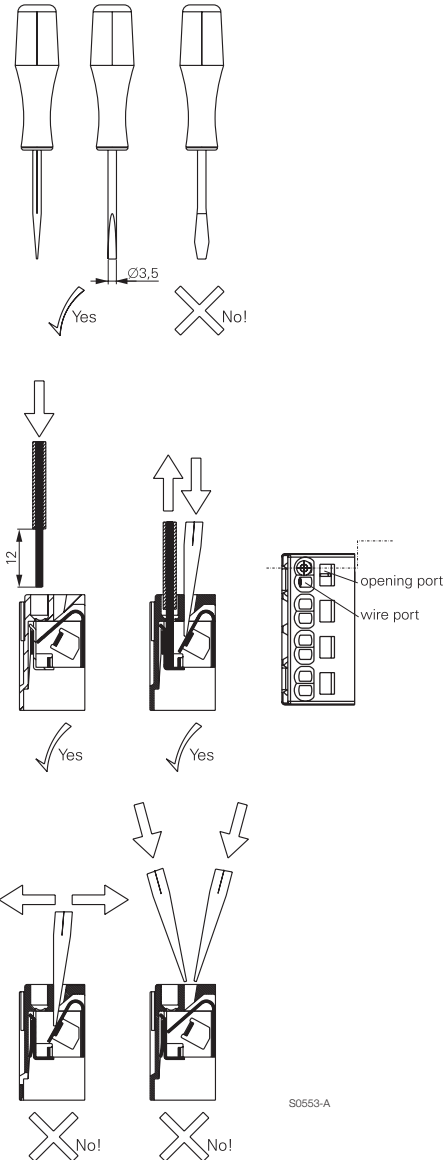

Jumper link

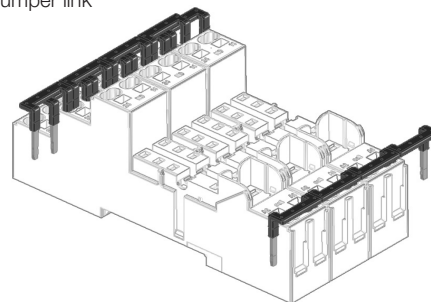

F0296-A

**Accessories Interface Plug-in Relay XT (Continued)**

**Socket with screw type terminals for DIN rail mounting**

**RT 78 726** Socket with screw-type terminals, logical terminal arrangement

- DIN-rail socket with logical setup of connections (input/output)
- High quality rising clamp terminals
- Captive combination terminal screws
- Jumper bars for interconnection

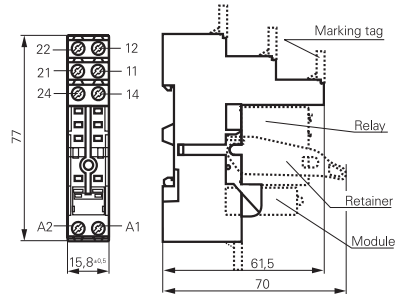
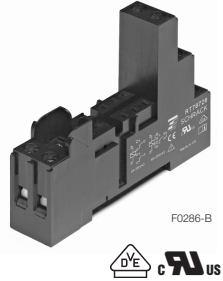

S0416-CX

**RT 78 725** Socket with screw-type terminals, conventional terminal arrangement

- Conventional terminal arrangement

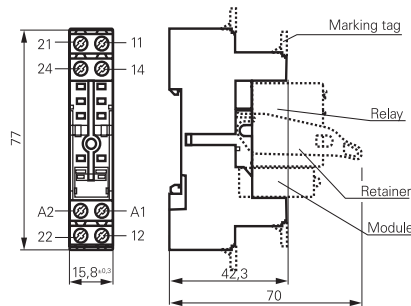
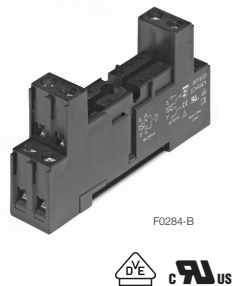

S0540-BX

**Approvals**

VDE Cert. No. 40017832, cULus E135149 in process

Technical data	RT 78 726	RT 78 725
Rated voltage/Max. switching voltage AC	240 / 400VAC	
Rated current	2 x 8A, 16 A*)	
Dielectric strength	coil contact circuit	5000 V <sub>rms</sub> / 4000 V <sub>rms</sub>
	open contact circuit	1000 V <sub>rms</sub> / 1000 V <sub>rms</sub>
	adjacent contact circuits	2500 V <sub>rms</sub> / 2500 V <sub>rms</sub>
Clearance / creepage	coil contact circuit	≥ 8/8 mm / ≥ 4.7/4.7 mm
	Material group of insulation parts	IIIa
Insulation to IEC 60664-1	Type of insulation coil-contact circuit	reinforced / basic
	open contact circuit	functional
	adjacent contact circuits	functional
Rated insulation voltage	250 V	
Pollution degree	2	
Rated voltage system	230 / 400 V	
Overvoltage category	III	
Material compliance: EU RoHS/ELV, China RoHS, REACH, Halogen content refer to the Product Compliance Support Center at <a href="http://www.te.com/customer-support/rohssupportcenter">www.te.com/customer-support/rohssupportcenter</a>		
Ambient temperature range	for mounting/handling	-20...+70°C
	in operation	-40...+70°C
Terminals	screw	
Terminals screw torque acc. IEC 61984		0.5 Nm
	max.	0.7 Nm

\*) For 1 pole relays (16 A) the relay terminals 11-21, 12-22 and 14-24 have to be bridged

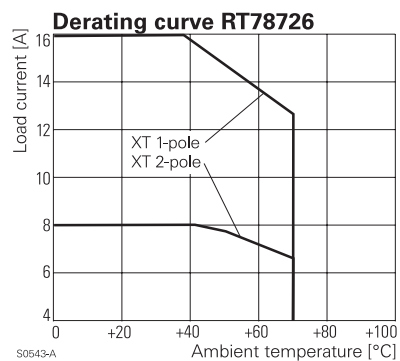

S0543-A

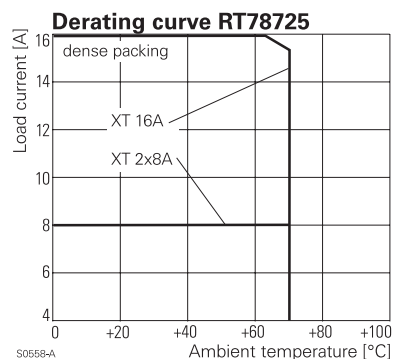

S0558-A

**Accessories Interface Plug-in Relay XT (Continued)**

Technical data (continued)	RT 78 726	RT 78 725
Wire cross section		
single wire	2 x 2.5 mm <sup>2</sup>	
fine wire	2 x 2.5 mm <sup>2</sup>	
with bootlace crimp (DIN 46228/1)	2 x 1.5 mm <sup>2</sup>	
Insertion cycles	A (10)	
Max. Insertion Force total	120 N	
Mounting distance	≥ 0, dense packing	
Weight	36 g	
Packaging unit	10 pcs	

Socket with screw type terminals for DIN rail mounting		
Type		Part Number
<b>RT 78 726</b>	Socket with screw type terminals, pinning 5 mm for DIN rail mounting, logical terminal arrangement	6-1415035-1
<b>RT 78 725</b>	Socket with screw type terminals, pinning 5 mm for DIN rail mounting, conventional terminal arrangement	1860306-1

Accessories for RT 78 725, RT 78 726		
Type		Part Number
<b>XT 17 017</b>	Plastic retaining clip, relay height 25.5 mm	2022104-1
<b>RT 17 040</b>	Marking tag	2-1415038-1
<b>RT 17 0R8</b>	Jumper bar, max load 12A for connection of up to 8 RT sockets	1860517-8
<b>XT 28 816</b>	Metal retaining clip, relay height 25.5 mm	1887204-1

**Marking tags**

- White marking area 15.5 x 6 mm
- Snaps on socket in up to 4 positions

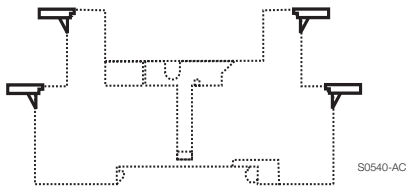
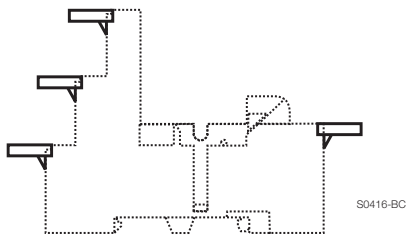

Jumper bar

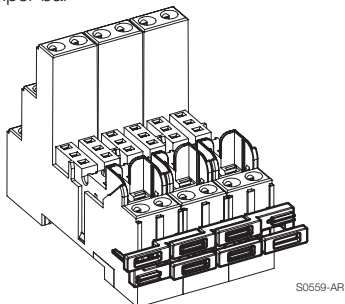

**LED- and Protection Modules for RT 78 72P, RT 78 725, RT 78 726**

Easy insertion of module into the socket  
Wiring in parallel to the coil

Type			Part Number
<b>PTM T0 0A0</b>	EM09	Protection diode (standard, A1+, A2-)	9-1415036-1
<b>PTM T0 0L0</b>	EM01	Protection diode (A1-, A2+)	1415037-1
<b>PTM U0 524</b>	EM02	RC-network 6...60 VAC	1-1415037-1
<b>PTM U0 730</b>	EM03	RC-network 110...230 VAC	2-1415037-1
<b>PTM V0 524</b>	EM04	Varistor 24 VAC	3-1415037-1
<b>PTM V0 615</b>	EM13	Varistor 115 VAC	6-1415365-1
<b>PTM V0 730</b>	EM05	Varistor 230 VAC	4-1415037-1
<b>PTM D0 730</b>	EM31	Residual current bypass RC 110...230 VAC	1415037-2
<b>PTM R0 730</b>	EM29	Residual current bypass resistor 110...230 VAC	1-1415539-2

**LED**

<b>PTM L0 024</b>	EM18	red LED 6...24 VDC w. prot. diode (std, A1+, A2-)	5-1415036-1
<b>PTM G0 024</b>	EM12	green LED 6...24 VDC w. prot. diode (std, A1+, A2-)	2-1415036-1
<b>PTM L1 024</b>	EM08	red LED 6...24 VDC w. prot. diode (A1-, A2+)	8-1415036-1
<b>PTM L0 060</b>	EM16	red LED 24...60 VDC w. prot. diode (std, A1+, A2-)	5-1415539-3
<b>PTM G0 060</b>	EM25	green LED 24...60 VDC w. prot. diode (std, A1+, A2-)	7-1415539-7
<b>PTM L0 110</b>	EM19	red LED 60...110 VDC w. prot. diode (A1+, A2-)	2-1415392-1
<b>PTM G0 110</b>	EM26	green LED 60...110 VDC w. prot. diode (A1+, A2-)	1-1415539-7
<b>PTM L0 220</b>	EM27	red LED 110...220 VDC w. prot. diode (A1+, A2-)	1-1415539-4
<b>PTM G0 220</b>	EM28	green LED 110...220 VDC w. prot. diode (A1+, A2-)	1-1415539-6
<b>PTM L0 524</b>	EM07	red LED 6...24 VDC/VAC	6-1415036-1
<b>PTM G0 524</b>	EM11	green LED 6...24 VDC/VAC	3-1415036-1
<b>PTM L0 560</b>	EM14	red LED 24...60 VDC/VAC	1-1415539-3
<b>PTM G0 560</b>	EM30	green LED 24...60 VDC/VAC	1-1415539-5
<b>PTM L0 730</b>	EM06	red LED 110...230 VAC	7-1415036-1
<b>PTM G0 730</b>	EM10	green LED 110...230 VAC	4-1415036-1

**Relay Packages**

Complete packages consisting of a relay mounted on a socket: see Relay Package XT





Компания «ЭлектроПласт» предлагает заключение долгосрочных отношений при поставках импортных электронных компонентов на взаимовыгодных условиях!

Наши преимущества:

- Оперативные поставки широкого спектра электронных компонентов отечественного и импортного производства напрямую от производителей и с крупнейших мировых складов;
- Поставка более 17-ти миллионов наименований электронных компонентов;
- Поставка сложных, дефицитных, либо снятых с производства позиций;
- Оперативные сроки поставки под заказ (от 5 рабочих дней);
- Экспресс доставка в любую точку России;
- Техническая поддержка проекта, помощь в подборе аналогов, поставка прототипов;
- Система менеджмента качества сертифицирована по Международному стандарту ISO 9001;
- Лицензия ФСБ на осуществление работ с использованием сведений, составляющих государственную тайну;
- Поставка специализированных компонентов (Xilinx, Altera, Analog Devices, Intersil, Interpoint, Microsemi, Aeroflex, Peregrine, Syfer, Eurofarad, Texas Instrument, Miteq, Cobham, E2V, MA-COM, Hittite, Mini-Circuits, General Dynamics и др.);

Помимо этого, одним из направлений компании «ЭлектроПласт» является направление «Источники питания». Мы предлагаем Вам помощь Конструкторского отдела:

- Подбор оптимального решения, техническое обоснование при выборе компонента;
- Подбор аналогов;
- Консультации по применению компонента;
- Поставка образцов и прототипов;
- Техническая поддержка проекта;
- Защита от снятия компонента с производства.



#### Как с нами связаться

**Телефон:** 8 (812) 309 58 32 (многоканальный)

**Факс:** 8 (812) 320-02-42

**Электронная почта:** [org@eplast1.ru](mailto:org@eplast1.ru)

**Адрес:** 198099, г. Санкт-Петербург, ул. Калинина, дом 2, корпус 4, литера А.