



Is Now Part of



**ON Semiconductor®**

To learn more about ON Semiconductor, please visit our website at  
[www.onsemi.com](http://www.onsemi.com)

Please note: As part of the Fairchild Semiconductor integration, some of the Fairchild orderable part numbers will need to change in order to meet ON Semiconductor's system requirements. Since the ON Semiconductor product management systems do not have the ability to manage part nomenclature that utilizes an underscore (\_), the underscore (\_) in the Fairchild part numbers will be changed to a dash (-). This document may contain device numbers with an underscore (\_). Please check the ON Semiconductor website to verify the updated device numbers. The most current and up-to-date ordering information can be found at [www.onsemi.com](http://www.onsemi.com). Please email any questions regarding the system integration to [Fairchild\\_questions@onsemi.com](mailto:Fairchild_questions@onsemi.com).

ON Semiconductor and the ON Semiconductor logo are trademarks of Semiconductor Components Industries, LLC dba ON Semiconductor or its subsidiaries in the United States and/or other countries. ON Semiconductor owns the rights to a number of patents, trademarks, copyrights, trade secrets, and other intellectual property. A listing of ON Semiconductor's product/patent coverage may be accessed at [www.onsemi.com/site/pdf/Patent-Marking.pdf](http://www.onsemi.com/site/pdf/Patent-Marking.pdf). ON Semiconductor reserves the right to make changes without further notice to any products herein. ON Semiconductor makes no warranty, representation or guarantee regarding the suitability of its products for any particular purpose, nor does ON Semiconductor assume any liability arising out of the application or use of any product or circuit, and specifically disclaims any and all liability, including without limitation special, consequential or incidental damages. Buyer is responsible for its products and applications using ON Semiconductor products, including compliance with all laws, regulations and safety requirements or standards, regardless of any support or applications information provided by ON Semiconductor. "Typical" parameters which may be provided in ON Semiconductor data sheets and/or specifications can and do vary in different applications and actual performance may vary over time. All operating parameters, including "Typicals" must be validated for each customer application by customer's technical experts. ON Semiconductor does not convey any license under its patent rights nor the rights of others. ON Semiconductor products are not designed, intended, or authorized for use as a critical component in life support systems or any FDA Class 3 medical devices or medical devices with a same or similar classification in a foreign jurisdiction or any devices intended for implantation in the human body. Should Buyer purchase or use ON Semiconductor products for any such unintended or unauthorized application, Buyer shall indemnify and hold ON Semiconductor and its officers, employees, subsidiaries, affiliates, and distributors harmless against all claims, costs, damages, and expenses, and reasonable attorney fees arising out of, directly or indirectly, any claim of personal injury or death associated with such unintended or unauthorized use, even if such claim alleges that ON Semiconductor was negligent regarding the design or manufacture of the part. ON Semiconductor is an Equal Opportunity/Affirmative Action Employer. This literature is subject to all applicable copyright laws and is not for resale in any manner.



# FPF1504 / FPF1504L

## Advanced Load Management Switch

### Features

- 1.0 V to 3.6 V Input Voltage Operating Range
- Typical  $R_{DS(ON)}$ :
  - 15 m $\Omega$  at  $V_{IN}=3.3$  V
  - 20 m $\Omega$  at  $V_{IN}=1.8$  V
  - 40 m $\Omega$  at  $V_{IN}=1.0$  V
- Slew Rate Control
- Output Discharge Function
- Low  $<1$   $\mu$ A Quiescent Current at  $V_{ON}=V_{IN}$
- ESD Protected: 4000 V HBM, 2000 V CDM
- GPIO/CMOS-Compatible Enable Circuitry
- Active HIGH and active LOW versions

### Applications

- Mobile Devices and Smart Phones
- Portable Media Devices
- Digital Cameras
- Advanced Notebook, UMPC, and MID
- Portable Medical Devices
- GPS and Navigation Equipment

### Description

The FPF1504/FPF1504L are low- $R_{DS}$  P-channel MOSFET load switches of the IntelliMAX™ family. Integrated slew-rate control prevents excessive inrush current from the supply rails with capacitive loads common in power applications. In addition, the FPF1504/FPF1504L feature output discharge capability.

The input voltage range operates from 1.0 V to 3.6 V to fulfill today's mobile device supply requirements. Switch control is by a logic input (ON pin) capable of interfacing directly with low-voltage CMOS control signals and GPIOs in embedded processors.

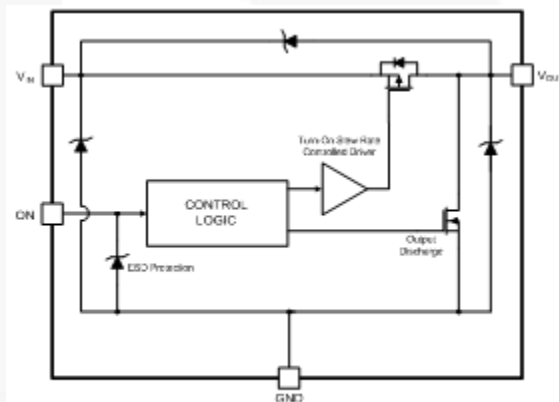

Figure 1. Block Diagram

### Ordering Information

Part Number	Top Mark	Switch (Typical) At 1.8 V <sub>IN</sub>	Input Buffer	Output Discharge	ON Pin Activity	Package
FPF1504UCX	G4	20 m $\Omega$	CMOS	YES	Active HIGH	4-Ball, WLCSP, 0.5 mm Pitch
FPF1504BUCX	G4	20 m $\Omega$	CMOS	YES	Active HIGH	4-Ball, WLCSP with Backside Laminate, 0.5 mm Pitch
FPF1504LUCX	GZ	20 m $\Omega$	CMOS	YES	Active LOW	4-Ball, WLCSP, 0.5 mm Pitch
FPF1504LBUCX	GZ	20 m $\Omega$	CMOS	YES	Active LOW	4-Ball, WLCSP with Backside Laminate, 0.5 mm Pitch

### Application Diagram

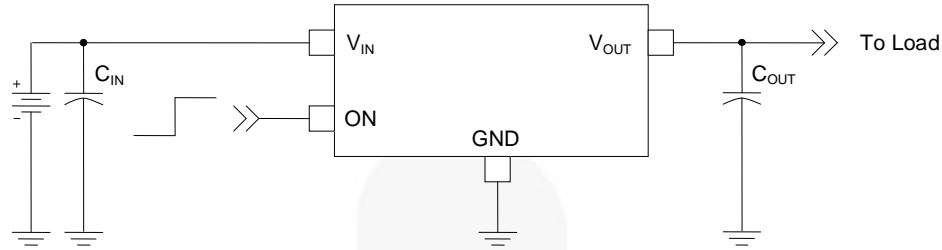

Figure 2. Typical Application

**Notes:**

1.  $C_{IN}=1\ \mu\text{F}$ , X5R, 0603, for example Murata GRM185R60J105KE26.
2.  $C_{OUT}=1\ \mu\text{F}$ , X5R, 0805, for example Murata GRM216R61A105KA01.

### Pin Configurations

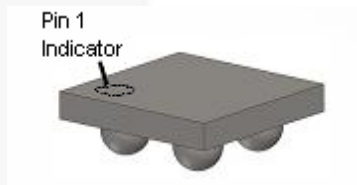

Figure 3. 1 x 1 mm WLCSP Bumps Facing Down

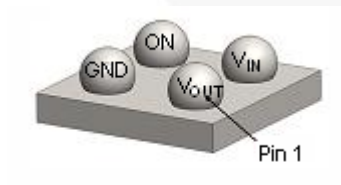

Figure 4. 1 x 1 mm WLCSP Bumps Facing Up

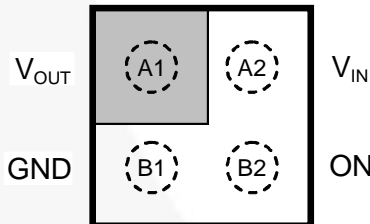

Figure 5. Pin Assignments (Top View)

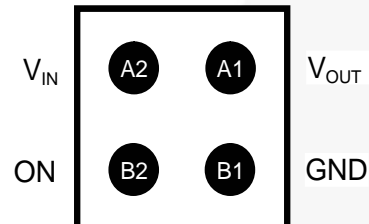

Figure 6. Pin Assignments (Bottom View)

### Pin Definitions

Pin #	Name	Description
A1	$V_{OUT}$	Switch Output
A2	$V_{IN}$	Supply Input; Input to the Power Switch
B1	GND	Ground
B2	ON	ON/OFF Control

## Absolute Maximum Ratings

Stresses exceeding the absolute maximum ratings may damage the device. The device may not function or be operable above the recommended operating conditions and stressing the parts to these levels is not recommended. In addition, extended exposure to stresses above the recommended operating conditions may affect device reliability. The absolute maximum ratings are stress ratings only.

Symbol	Parameter	Min.	Max.	Unit
$V_{IN}$	$V_{IN}$ , $V_{OUT}$ , $V_{ON}$ to GND	-0.3	4.0	V
$I_{SW}$	Maximum Continuous Switch Current		1.5	A
$P_D$	Power Dissipation at $T_A=25^\circ\text{C}$		1.0	W
$T_{STG}$	Storage Junction Temperature	-65	+150	$^\circ\text{C}$
$T_A$	Operating Temperature Range	-40	+85	$^\circ\text{C}$
$\Theta_{JA}$	Thermal Resistance, Junction-to-Ambient	1S2P with 1 Thermal Via	95	$^\circ\text{C}/\text{W}$
		1S2P without Thermal Via	187	
ESD	Electrostatic Discharge Capability	Human Body Model, JESD22-A114	4	kV
		Charged Device Model, JESD22-C101	2	

## Recommended Operating Conditions

The Recommended Operating Conditions table defines the conditions for actual device operation. Recommended operating conditions are specified to ensure optimal performance to the datasheet specifications. Fairchild does not recommend exceeding them or designing to Absolute Maximum Ratings.

Symbol	Parameter	Min.	Max.	Unit
$V_{IN}$	Supply Voltage	1.0	3.6	V
$T_A$	Ambient Operating Temperature	-40	+85	$^\circ\text{C}$

## Electrical Characteristics

Unless otherwise noted,  $V_{IN}=1.0$  to  $3.6$  V,  $T_A=-40$  to  $+85^\circ\text{C}$ ; typical values are at  $V_{IN}=3.3$  V and  $T_A=25^\circ\text{C}$ .

Symbol	Parameter		Conditions	Min.	Typ.	Max.	Units
<b>Basic Operation</b>							
$V_{IN}$	Supply Voltage			1.0		3.6	V
$I_{Q(OFF)}$	Off Supply Current	FPF1504	$V_{ON}=\text{GND}, V_{OUT}=\text{Open}$		0.25		$\mu\text{A}$
		FPF1504L	$V_{ON}=V_{IN}, V_{OUT}=\text{Open}$		0.3		
$I_{SD(OFF)}$	Off Switch Current	FPF1504	$V_{ON}=\text{GND}, V_{OUT}=\text{GND}$		0.25		
		FPF1504L	$V_{ON}=V_{IN}, V_{OUT}=\text{GND}$		0.3		
$I_Q$	Quiescent Current	FPF1504	$I_{OUT}=0$ mA, $V_{IN}=3.6$ V, $V_{ON}=V_{IN}$		0.08		
			$I_{OUT}=0$ mA, $V_{ON}=V_{IH(MIN)}$		0.75		
		FPF1504L	$I_{OUT}=0$ mA, $V_{IN}=3.6$ V, $V_{ON}=\text{GND}$		0.08		
			$I_{OUT}=0$ mA, $V_{ON}=V_{IL(MAX)}$		0.95		
$R_{ON}$	On Resistance	$V_{IN}=3.3$ V, $I_{OUT}=200$ mA, $T_A=25^\circ\text{C}$			15	30	m $\Omega$
		$V_{IN}=1.8$ V, $I_{OUT}=200$ mA, $T_A=25^\circ\text{C}$			20	40	
		$V_{IN}=1.5$ V, $I_{OUT}=200$ mA, $T_A=25^\circ\text{C}$			30		
		$V_{IN}=1.0$ V, $I_{OUT}=200$ mA, $T_A=25^\circ\text{C}$			40	80	
		$V_{IN}=1.8$ V, $I_{OUT}=200$ mA, $T_A=85^\circ\text{C}^{(3)}$			35	50	
$R_{PD}$	Output Discharge Pull-Down Resistance		$V_{ON}=0$ V or $V_{IN}$ , $I_{OUT}=-20$ mA		65	95	$\Omega$
$V_{IH}$	On Input Logic High Voltage	FPF1504		0.8			V
$V_{IL}$	On Input Logic Low Voltage	FPF1504			0.3		
$I_{ON}$	On Input Leakage		$V_{ON}=V_{IN}$ or GND			1	$\mu\text{A}$
<b>Dynamic Characteristics</b>							
$t_{DON}$	Turn-On Delay <sup>(4)</sup>	FPF1504	$R_L=10$ $\Omega$ , $C_L=0.1$ $\mu\text{F}$ , $V_{IN}=3.3$ V, $T_A=25^\circ\text{C}$		80		$\mu\text{s}$
$t_R$	$V_{OUT}$ Rise Time <sup>(4)</sup>	FPF1504			130		
$t_{ON}$	Turn-On Time <sup>(4)</sup>	FPF1504			210		
$t_{DON}$	Turn-On Delay <sup>(4)</sup>	FPF1504	$R_L=500$ $\Omega$ , $C_L=0.1$ $\mu\text{F}$ , $V_{IN}=3.3$ V, $T_A=25^\circ\text{C}$		70	100	$\mu\text{s}$
		FPF1504L			95		
$t_R$	$V_{OUT}$ Rise Time <sup>(4)</sup>	FPF1504			110	150	
		FPF1504L			115		
$t_{ON}$	Turn-On Time <sup>(4)</sup>	FPF1504			180	250	
		FPF1504L			210		

Continued on the following page...

## Electrical Characteristics (Continued)

Unless otherwise noted,  $V_{IN}=1.0$  to  $3.6$  V,  $T_A=-40$  to  $+85^\circ\text{C}$ ; typical values are at  $V_{IN}=3.3$  V and  $T_A=25^\circ\text{C}$ .

Symbol	Parameter	Conditions	Min.	Typ.	Max.	Units
<b>Dynamic Characteristics (Continued)</b>						
$t_{DOFF}$	Turn-Off Delay <sup>(4)</sup>	FPF1504		25	30	$\mu\text{s}$
$t_F$	$V_{OUT}$ Fall Time <sup>(4)</sup>	FPF1504	$R_L=10\ \Omega$ , $C_L=0.1\ \mu\text{F}$ , $V_{IN}=3.3\ \text{V}$ , $T_A=25^\circ\text{C}$	2		
$t_{OFF}$	Turn-Off Time <sup>(4)</sup>	FPF1504		27		
$t_{DOFF}$	Turn-Off Delay <sup>(4)</sup>	FPF1504 FPF1504L			25 2	
$t_F$	$V_{OUT}$ Fall Time <sup>(4)</sup>	FPF1504 FPF1504L	$R_L=500\ \Omega$ , $C_L=0.1\ \mu\text{F}$ , $V_{IN}=3.3\ \text{V}$ , $T_A=25^\circ\text{C}$	12 14		
$t_{OFF}$	Turn-Off Time <sup>(4)</sup>	FPF1504 FPF1504L		37 16		

**Notes:**

3. This parameter is guaranteed by design and characterization; not production tested.
4.  $t_{DON}/t_{DOFF}/t_R/t_F$  are defined in Figure 7.
5. Output discharge path is enabled during off.

### Timing Diagram – FPF1504

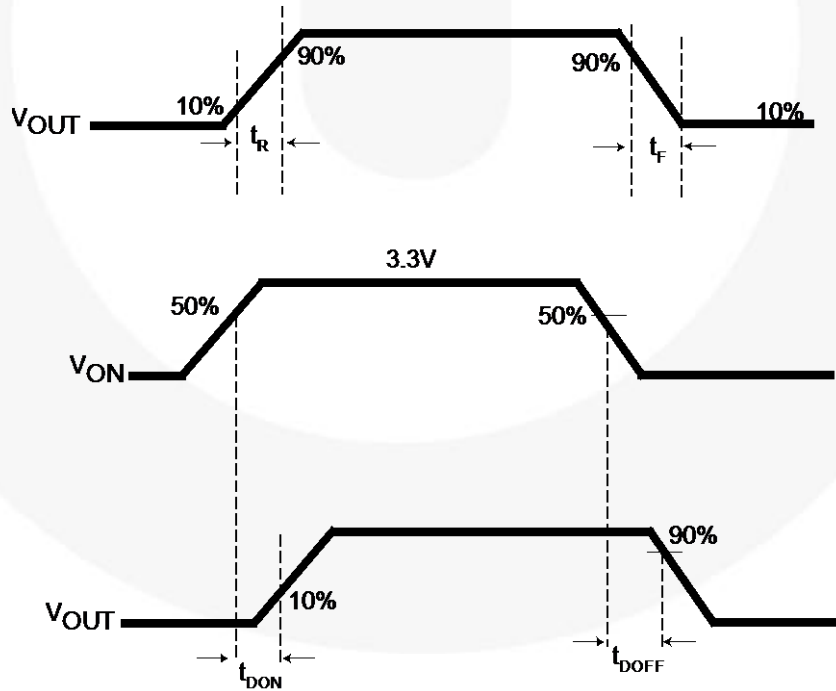

**Notes:**

6.  $t_{ON}=t_R + t_{DON}$ .
7.  $t_{OFF}=t_F + t_{DOFF}$ .

Figure 7. Timing Diagram for FPF1504

## Typical Performance Characteristics for FPF1504

Applicable to active high version only.

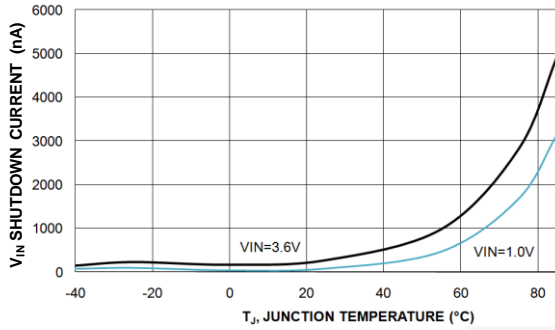

**Figure 8. Shutdown Current vs. Temperature**

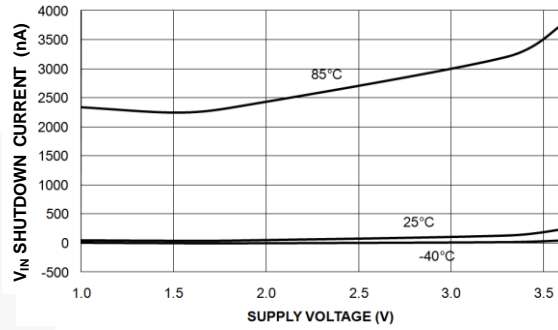

**Figure 9. Shutdown Current vs. Supply Voltage**

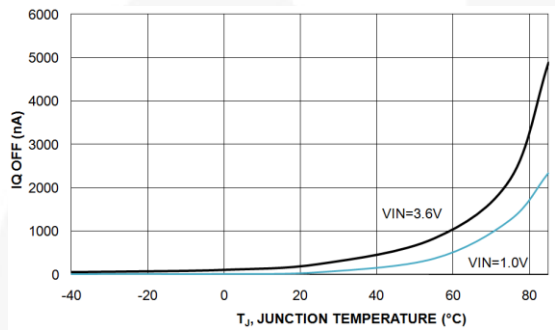

**Figure 10. Off Supply Current vs. Temperature**

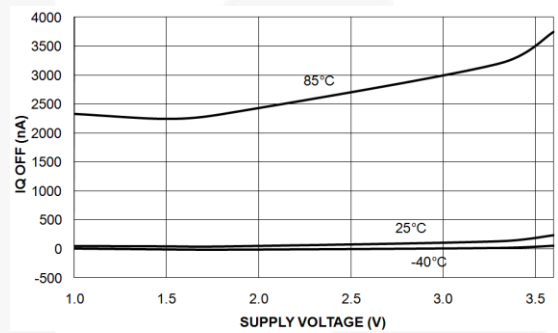

**Figure 11. Off Supply Current vs. Supply Voltage**

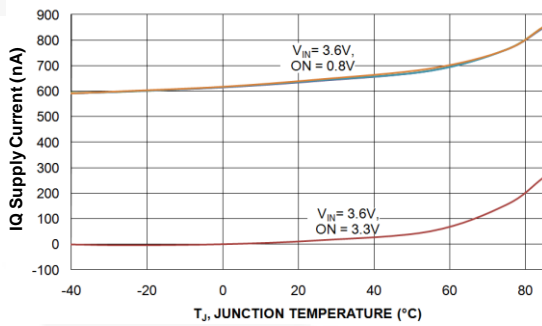

**Figure 12. Quiescent Current vs. Temperature**

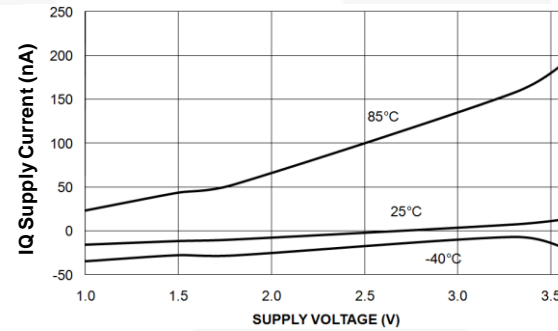

**Figure 13. Quiescent Current vs. Supply Voltage (V<sub>ON</sub>=V<sub>IN</sub>)**

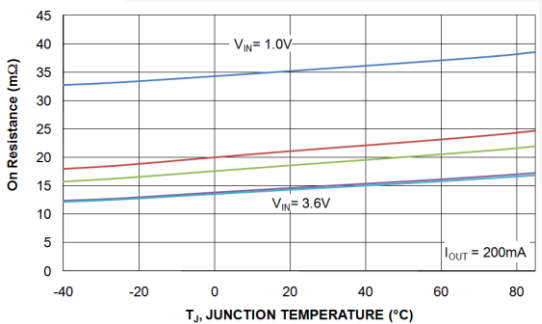

**Figure 14. R<sub>ON</sub> vs. Temperature**

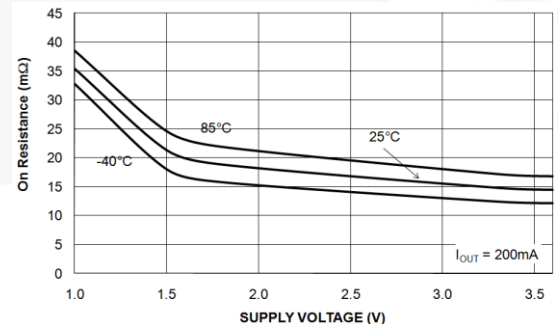

**Figure 15. R<sub>ON</sub> vs. Supply Voltage**

## Typical Performance Characteristics for FPF1504

Applicable to active high version only.

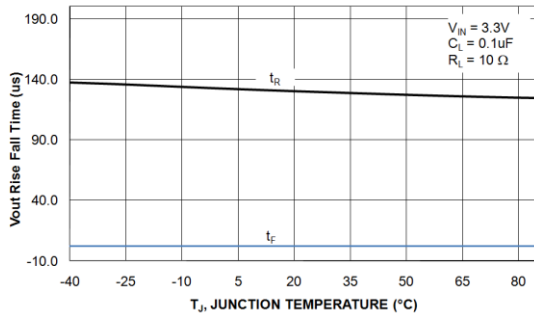

Figure 16.  $V_{OUT}$  Rise/Fall Times vs. Temperature ( $R_L=10\ \Omega$ )

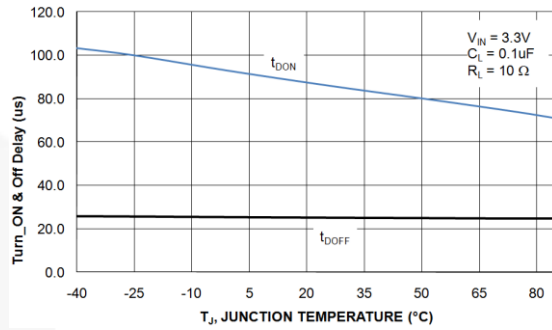

Figure 17.  $V_{OUT}$  Turn-On/Turn-Off Delays vs. Temperature ( $R_L=10\ \Omega$ )

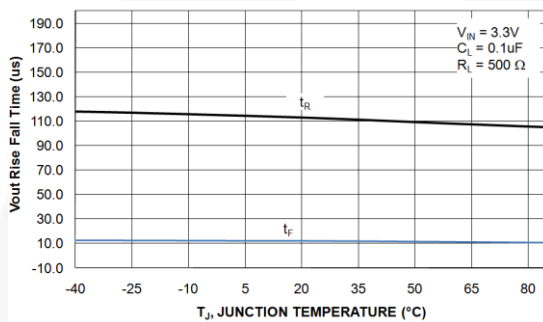

Figure 18.  $V_{OUT}$  Rise/Fall Time vs. Temperature ( $R_L=500\ \Omega$ )

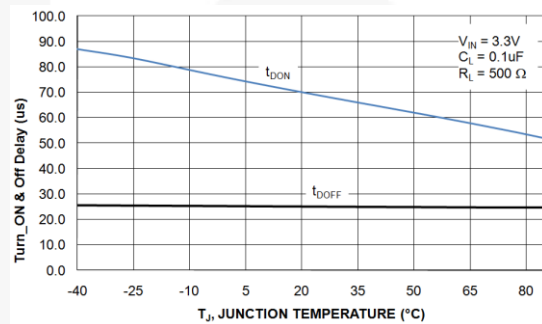

Figure 19.  $V_{OUT}$  Turn-On/Turn-Off Delays vs. Temperature ( $R_L=500\ \Omega$ )

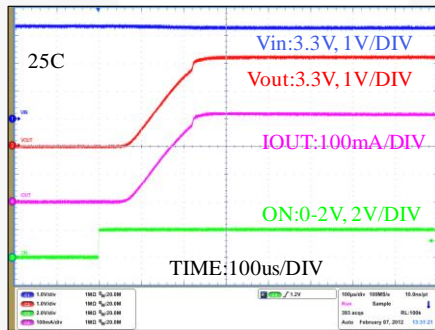

Figure 20. Turn-On Response ( $V_{IN}=3.3\ \text{V}$ ,  $C_{OUT}=0.1\ \mu\text{F}$ ,  $R_L=10\ \Omega$ )

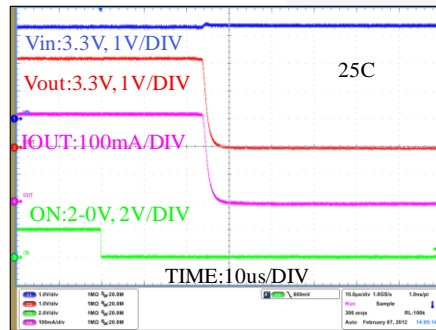

Figure 21. Turn-Off Response ( $V_{IN}=3.3\ \text{V}$ ,  $C_{OUT}=0.1\ \mu\text{F}$ ,  $R_L=10\ \Omega$ )

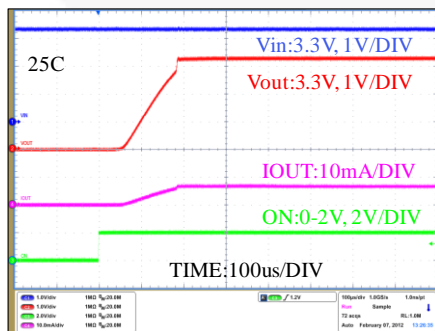

Figure 22. Turn-On Response ( $V_{IN}=3.3\ \text{V}$ ,  $C_{OUT}=0.1\ \mu\text{F}$ ,  $R_L=500\ \Omega$ )

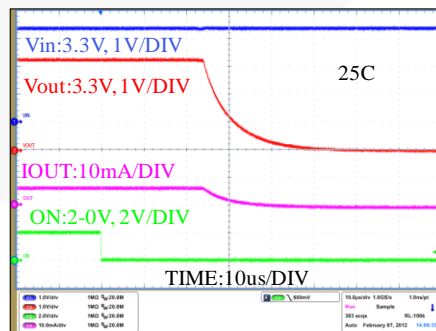

Figure 23. Turn-Off Response ( $V_{IN}=3.3\ \text{V}$ ,  $C_{OUT}=0.1\ \mu\text{F}$ ,  $R_L=500\ \Omega$ )



## Application Information

### Input Capacitor

IntelliMAX™ switches don't require an input capacitor. To reduce device inrush current, a 0.1 μF ceramic capacitor, C<sub>IN</sub>, is recommended close to the VIN pin. A higher value of C<sub>IN</sub> can be used to further reduce the voltage drop experienced as the switch is turned on into a large capacitive load.

### Output Capacitor

IntelliMAX™ switches work without an output capacitor. If the applications parasitic board inductance forces V<sub>OUT</sub> below GND when switching off, a 0.1 μF capacitor, C<sub>OUT</sub>, should be placed between V<sub>OUT</sub> and GND.

### Fall Time

Device output fall time can be calculated based on RC constant of external components as follows:

$$t_F = R_L \times C_L \times 2.2 \quad (1)$$

where t<sub>F</sub> is 90% to 10% fall time, R<sub>L</sub> is output load, load and C<sub>L</sub> is output capacitor.

The same equation works for a device with a pull-down output resistor, then R<sub>L</sub> is replaced by a parallel connected pull-down and external output resistor combination, as follows:

$$t_F = \frac{R_L \times R_{PD}}{R_L + R_{PD}} \times C_L \times 2.2 \quad (2)$$

where t<sub>F</sub> is 90% to 10% fall time, R<sub>L</sub> is output load, R<sub>PD</sub> is output pull-down resistor (65 Ω typical), and C<sub>L</sub> is the output capacitor.

## Recommended Land Pattern and Layout

For best thermal performance and minimal inductance and parasitic effects, it is recommended to keep input and output traces short and the capacitors as close to

the device as possible. Below is a recommended layout for this device to achieve optimum performance.

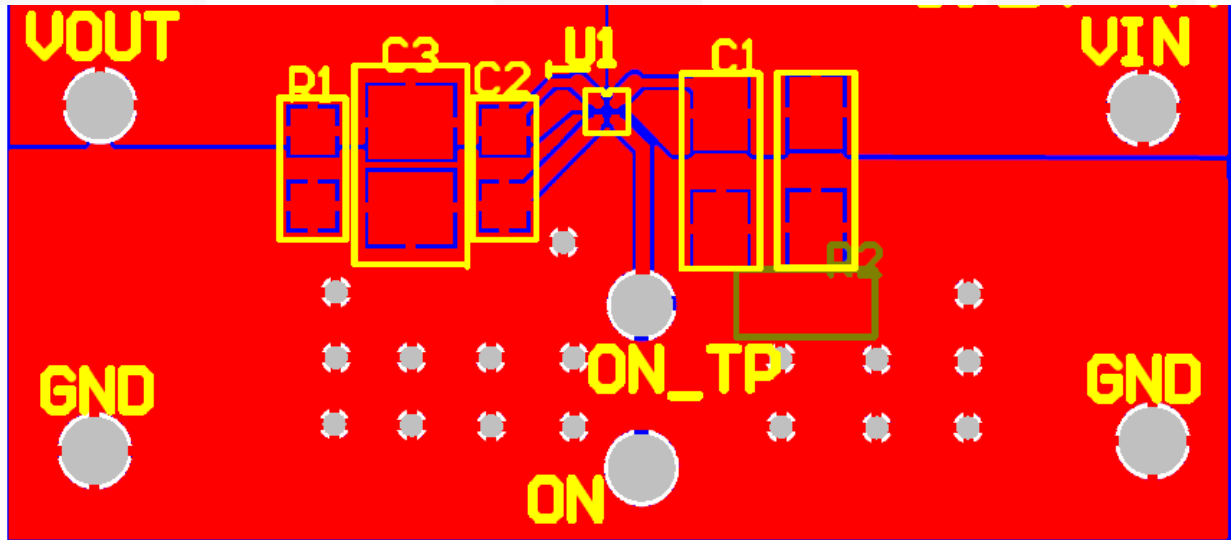

Figure 24. Recommended Land Pattern and Layout

The following information applies to the WLCSP package dimensions on the next page:

**Product-Specific Dimensions**

Product	D	E	X	Y
FPF1504UCX	960 $\mu\text{m}$ $\pm$ 30 $\mu\text{m}$	960 $\mu\text{m}$ $\pm$ 30 $\mu\text{m}$	0.230 mm	0.230 mm
FPF1504BUCX				
FPF1504LUCX				
FPF1504LBUCX				



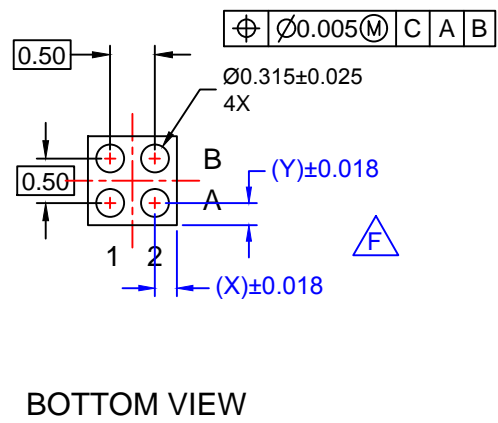
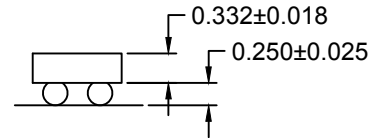
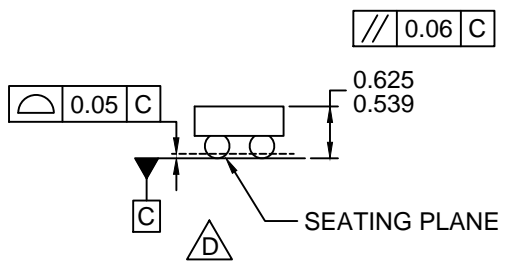
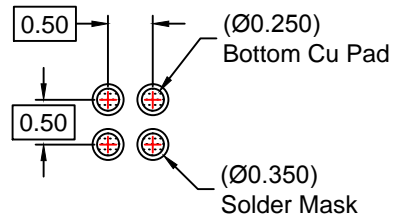
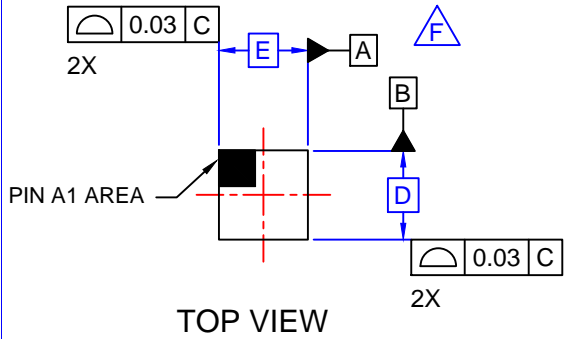

- NOTES:
- A. NO JEDEC REGISTRATION APPLIES.
  - B. DIMENSIONS ARE IN MILLIMETERS.
  - C. DIMENSIONS AND TOLERANCES PER ASME Y14.5M, 2009.
  - D. DATUM C IS DEFINED BY THE SPHERICAL CROWNS OF THE BALLS.
  - E. PACKAGE NOMINAL HEIGHT IS 582 MICRONS ±43 MICRONS (539-625 MICRONS).
  - F. FOR DIMENSIONS D, E, X, AND Y SEE PRODUCT DATASHEET.
  - G. DRAWING FILENAME: MKT-UC004ABrev3.



ON Semiconductor and  are trademarks of Semiconductor Components Industries, LLC dba ON Semiconductor or its subsidiaries in the United States and/or other countries. ON Semiconductor owns the rights to a number of patents, trademarks, copyrights, trade secrets, and other intellectual property. A listing of ON Semiconductor's product/patent coverage may be accessed at [www.onsemi.com/site/pdf/Patent-Marking.pdf](http://www.onsemi.com/site/pdf/Patent-Marking.pdf). ON Semiconductor reserves the right to make changes without further notice to any products herein. ON Semiconductor makes no warranty, representation or guarantee regarding the suitability of its products for any particular purpose, nor does ON Semiconductor assume any liability arising out of the application or use of any product or circuit, and specifically disclaims any and all liability, including without limitation special, consequential or incidental damages. Buyer is responsible for its products and applications using ON Semiconductor products, including compliance with all laws, regulations and safety requirements or standards, regardless of any support or applications information provided by ON Semiconductor. "Typical" parameters which may be provided in ON Semiconductor data sheets and/or specifications can and do vary in different applications and actual performance may vary over time. All operating parameters, including "Typicals" must be validated for each customer application by customer's technical experts. ON Semiconductor does not convey any license under its patent rights nor the rights of others. ON Semiconductor products are not designed, intended, or authorized for use as a critical component in life support systems or any FDA Class 3 medical devices or medical devices with a same or similar classification in a foreign jurisdiction or any devices intended for implantation in the human body. Should Buyer purchase or use ON Semiconductor products for any such unintended or unauthorized application, Buyer shall indemnify and hold ON Semiconductor and its officers, employees, subsidiaries, affiliates, and distributors harmless against all claims, costs, damages, and expenses, and reasonable attorney fees arising out of, directly or indirectly, any claim of personal injury or death associated with such unintended or unauthorized use, even if such claim alleges that ON Semiconductor was negligent regarding the design or manufacture of the part. ON Semiconductor is an Equal Opportunity/Affirmative Action Employer. This literature is subject to all applicable copyright laws and is not for resale in any manner.

## PUBLICATION ORDERING INFORMATION

### LITERATURE FULFILLMENT:

Literature Distribution Center for ON Semiconductor  
19521 E. 32nd Pkwy, Aurora, Colorado 80011 USA  
**Phone:** 303-675-2175 or 800-344-3860 Toll Free USA/Canada  
**Fax:** 303-675-2176 or 800-344-3867 Toll Free USA/Canada  
**Email:** [orderlit@onsemi.com](mailto:orderlit@onsemi.com)

**N. American Technical Support:** 800-282-9855 Toll Free  
USA/Canada  
**Europe, Middle East and Africa Technical Support:**  
Phone: 421 33 790 2910  
**Japan Customer Focus Center**  
Phone: 81-3-5817-1050

**ON Semiconductor Website:** [www.onsemi.com](http://www.onsemi.com)  
**Order Literature:** <http://www.onsemi.com/orderlit>  
For additional information, please contact your local  
Sales Representative

# Mouser Electronics

Authorized Distributor

Click to View Pricing, Inventory, Delivery & Lifecycle Information:

[ON Semiconductor:](#)

[FPF1504UCX](#) [FPF1504BUCX](#)



Компания «ЭлектроПласт» предлагает заключение долгосрочных отношений при поставках импортных электронных компонентов на взаимовыгодных условиях!

Наши преимущества:

- Оперативные поставки широкого спектра электронных компонентов отечественного и импортного производства напрямую от производителей и с крупнейших мировых складов;
- Поставка более 17-ти миллионов наименований электронных компонентов;
- Поставка сложных, дефицитных, либо снятых с производства позиций;
- Оперативные сроки поставки под заказ (от 5 рабочих дней);
- Экспресс доставка в любую точку России;
- Техническая поддержка проекта, помощь в подборе аналогов, поставка прототипов;
- Система менеджмента качества сертифицирована по Международному стандарту ISO 9001;
- Лицензия ФСБ на осуществление работ с использованием сведений, составляющих государственную тайну;
- Поставка специализированных компонентов (Xilinx, Altera, Analog Devices, Intersil, Interpoint, Microsemi, Aeroflex, Peregrine, Syfer, Eurofarad, Texas Instrument, Miteq, Cobham, E2V, MA-COM, Hittite, Mini-Circuits, General Dynamics и др.);

Помимо этого, одним из направлений компании «ЭлектроПласт» является направление «Источники питания». Мы предлагаем Вам помощь Конструкторского отдела:

- Подбор оптимального решения, техническое обоснование при выборе компонента;
- Подбор аналогов;
- Консультации по применению компонента;
- Поставка образцов и прототипов;
- Техническая поддержка проекта;
- Защита от снятия компонента с производства.



#### Как с нами связаться

**Телефон:** 8 (812) 309 58 32 (многоканальный)

**Факс:** 8 (812) 320-02-42

**Электронная почта:** [org@eplast1.ru](mailto:org@eplast1.ru)

**Адрес:** 198099, г. Санкт-Петербург, ул. Калинина, дом 2, корпус 4, литера А.