



24AA02E48/24AA025E48/ 24AA02E64/24AA025E64

2K I²C Serial EEPROMs with EUI-48™ or EUI-64™ Node Identity

Device Selection Table

Part Number	Vcc Range	Max. Clock Frequency	Temp. Ranges	Cascadable	Page Size	Node Address
24AA02E48	1.7V-5.5V	400 kHz ⁽¹⁾	I	No	8-Byte	EUI-48™
24AA025E48	1.7V-5.5V	400 kHz ⁽¹⁾	I	Yes	16-Byte	EUI-48™
24AA02E64	1.7V-5.5V	400 kHz ⁽¹⁾	I	No	8-Byte	EUI-64™
24AA025E64	1.7V-5.5V	400 kHz ⁽¹⁾	I	Yes	16-Byte	EUI-64™

Note 1: 100 kHz for Vcc <2.5V

Features

- Pre-Programmed Globally Unique, 48-bit or 64-bit Node Address
- Compatible with EUI-48™ and EUI-64™
- Single Supply with Operation Down to 1.7V
- Low-Power CMOS Technology:
 - Read current 1 mA, maximum
 - Standby current: 1 μ A, maximum (I-Temp.)
5 μ A, maximum (E-Temp.)
- 2-Wire Serial Interface, I²C Compatible
- Schmitt Trigger Inputs for Noise Suppression
- Output Slope Control to Eliminate Ground Bounce
- 100 kHz and 400 kHz Clock Compatibility
- Page Write Time 3 ms, typical
- Self-Timed Erase/Write Cycle
- Page Write Buffer:
 - 8-byte page (24AA02E48/24AA02E64)
 - 16-byte page (24AA025E48/24AA025E64)
- ESD Protection >4,000V
- More than 1 Million Erase/Write Cycles
- Data Retention >200 Years
- Factory Programming Available
- Available Packages:
 - 8-lead SOIC and 5-lead SOT-23 (24AA02E48/24AA02E64)
 - 8-lead SOIC and 6-lead SOT-23 (24AA025E48/24AA025E64)
- RoHS Compliant
- Available for Extended Temperature Ranges:
 - Industrial (I): -40°C to +85°C
 - Automotive (E): -40°C to +125°C

Description

The Microchip Technology Inc. 24AA02E48/24AA025E48/24AA02E64/24AA025E64 (24AA02EXXX) is a 2 Kbit Electrically Erasable PROM. The device is organized as two blocks of 128 x 8-bit memory with a 2-wire serial interface. Low-voltage design permits operation down to 1.7V, with maximum standby currents of only 1 μ A for I-Temp. and 5 μ A for E-Temp., as well as a maximum active current of 1 mA. The 24AA02EXXX also has a page write capability for up to eight bytes of data (16 bytes on the 24AA025E48/24AA025E64). The 24AA02EXXX is available in the standard 8-pin SOIC, 5-lead SOT-23, and 6-lead SOT-23 packages.

Note: 24AA02EXXX is used in this document as a generic part number for the 24AA02E48/24AA025E48/24AA02E64/24AA025E64 devices.

Packages (24AA02E48/24AA02E64)

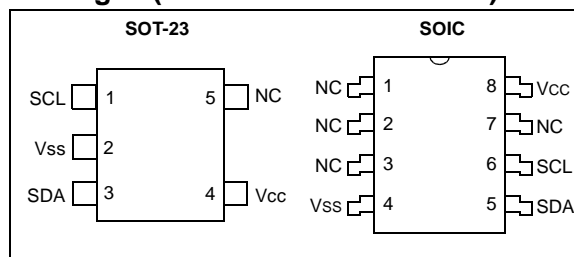

Packages (24AA025E48/24AA025E64)

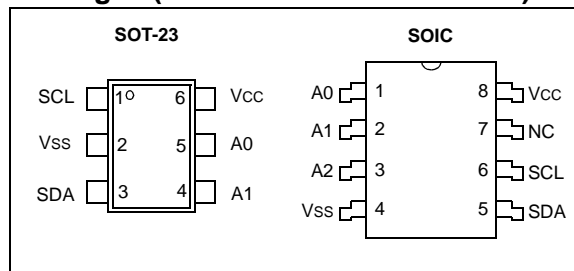

Block Diagram



1.0 ELECTRICAL CHARACTERISTICS

Absolute Maximum Ratings (†)

VCC.....	6.5V
All inputs and outputs w.r.t. VSS	-0.3V to VCC +1.0V
Storage temperature	-65°C to +150°C
Ambient temperature with power applied.....	-40°C to +125°C
ESD protection on all pins	≥4 kV

† **NOTICE:** Stresses above those listed under “Absolute Maximum Ratings” may cause permanent damage to the device. This is a stress rating only and functional operation of the device at those or any other conditions above those indicated in the operational listings of this specification is not implied. Exposure to maximum rating conditions for extended periods may affect device reliability.

TABLE 1-1: DC CHARACTERISTICS

DC CHARACTERISTICS			Industrial (I): TA = -40°C to +85°C, VCC = +1.7V to +5.5V Automotive (E): TA = -40°C to +125°C, VCC = +1.7V to +5.5V				
Param. No.	Symbol	Characteristic	Min.	Typ.	Max.	Units	Conditions
D1	V _{IH}	High-Level Input Voltage	0.7 V _{CC}	—	—	V	
D2	V _{IL}	Low-Level Input Voltage	—	—	0.3 V _{CC}	V	
D3	V _{HYS}	Hysteresis of Schmitt Trigger Inputs	0.05 V _{CC}	—	—	V	Note
D4	V _{OL}	Low-Level Output Voltage	—	—	0.40	V	I _{OL} = 3.0 mA, V _{CC} = 2.5V
D5	I _{LI}	Input Leakage Current	—	—	±1	µA	V _{IN} = V _{SS} or V _{CC}
D6	I _{LO}	Output Leakage Current	—	—	±1	µA	V _{OUT} = V _{SS} or V _{CC}
D7	C _{IN} , C _{OUT}	Pin Capacitance (all inputs/outputs)	—	—	10	pF	V _{CC} = 5.0V (Note) TA = 25°C, F _{CLK} = 1 MHz
D8	I _{CCWRITE}	Operating Current	—	0.1	3	mA	V _{CC} = 5.5V, SCL = 400 kHz
D9	I _{CCREAD}		—	0.05	1	mA	
D10	I _{CCS}	Standby Current	—	0.01	1	µA	Industrial (I) SDA = SCL = V _{CC}
			—	0.01	5	µA	Automotive (E) SDA = SCL = V _{CC}

Note: This parameter is periodically sampled and not 100% tested.

TABLE 1-2: AC CHARACTERISTICS

AC CHARACTERISTICS			Industrial (I):		TA = -40°C to +85°C, VCC = +1.7V to +5.5V		
			Automotive (E):		TA = -40°C to +125°C, VCC = +1.7V to +5.5V		
Param. No.	Symbol	Characteristic	Min.	Typ.	Max.	Units	Conditions
1	FCLK	Clock Frequency	—	—	400	kHz	2.5V ≤ VCC ≤ 5.5V
			—	—	100	kHz	1.7V ≤ VCC < 2.5V
2	THIGH	Clock High Time	600	—	—	ns	2.5V ≤ VCC ≤ 5.5V
			4000	—	—	ns	1.7V ≤ VCC < 2.5V
3	TLOW	Clock Low Time	1300	—	—	ns	2.5V ≤ VCC ≤ 5.5V
			4700	—	—	ns	1.7V ≤ VCC < 2.5V
4	TR	SDA and SCL Rise Time (Note 1)	—	—	300	ns	2.5V ≤ VCC ≤ 5.5V (Note 1)
			—	—	1000	ns	1.7V ≤ VCC < 2.5V (Note 1)
5	TF	SDA and SCL Fall Time	—	—	300	ns	Note 1
6	THD:STA	Start Condition Hold Time	600	—	—	ns	2.5V ≤ VCC ≤ 5.5V
			4000	—	—	ns	1.7V ≤ VCC < 2.5V
7	TSU:STA	Start Condition Setup Time	600	—	—	ns	2.5V ≤ VCC ≤ 5.5V
			4700	—	—	ns	1.7V ≤ VCC < 2.5V
8	THD:DAT	Data Input Hold Time	0	—	—	ns	Note 2
9	TSU:DAT	Data Input Setup Time	100	—	—	ns	2.5V ≤ VCC ≤ 5.5V
			250	—	—	ns	1.7V ≤ VCC < 2.5V
10	TSU:STO	Stop Condition Setup Time	600	—	—	ns	2.5V ≤ VCC ≤ 5.5V
			4000	—	—	ns	1.7V ≤ VCC < 2.5V
11	TAA	Output Valid from Clock (Note 2)	—	—	900	ns	2.5V ≤ VCC ≤ 5.5V
			—	—	3500	ns	1.7V ≤ VCC < 2.5V
12	TBUF	Bus Free Time: Bus time must be free before a new transmission can start	1300	—	—	ns	2.5V ≤ VCC ≤ 5.5V
			4700	—	—	ns	1.7V ≤ VCC < 2.5V
13	TOF	Output Fall Time from VIH Minimum to VIL Maximum	—	—	250	ns	2.5V ≤ VCC ≤ 5.5V
			—	—	250	ns	1.7V ≤ VCC < 2.5V
14	TSP	Input Filter Spike Suppression (SDA and SCL pins)	—	—	50	ns	Notes 1 and 3
15	TWC	Write Cycle Time (byte or page)	—	—	5	ms	
16		Endurance	1M	—	—	cycles	25°C (Note 4)

Note 1: Not 100% tested. CB = total capacitance of one bus line in pF.

2: As a transmitter, the device must provide an internal minimum delay time to bridge the undefined region (minimum 300 ns) of the falling edge of SCL to avoid unintended generation of Start or Stop conditions.

3: The combined TSP and VHYS specifications are due to new Schmitt Trigger inputs which provide improved noise spike suppression. This eliminates the need for a TI specification for standard operation.

4: This parameter is not tested but ensured by characterization. For endurance estimates in a specific application, please consult the Total Endurance™ Model which can be obtained from Microchip's website at www.microchip.com.

FIGURE 1-1: BUS TIMING DATA

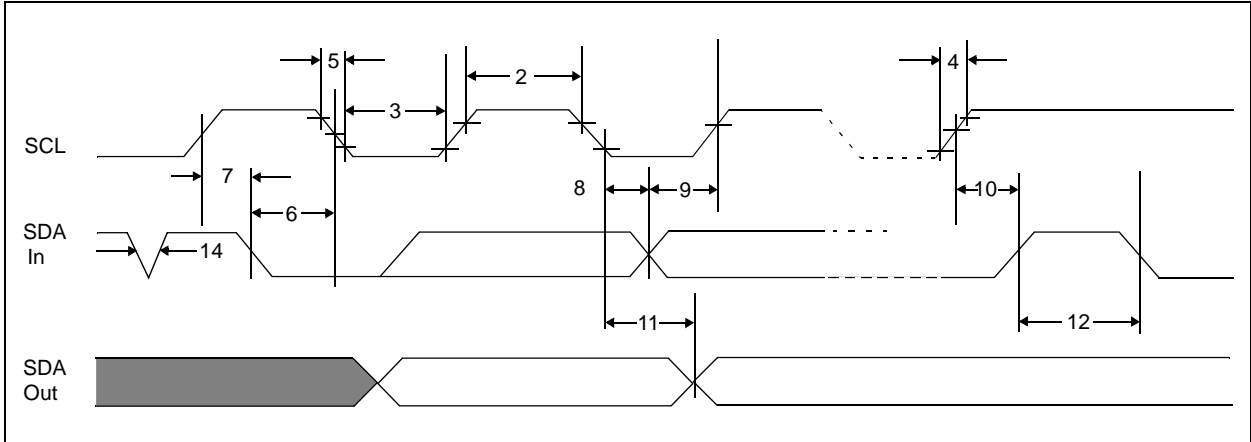
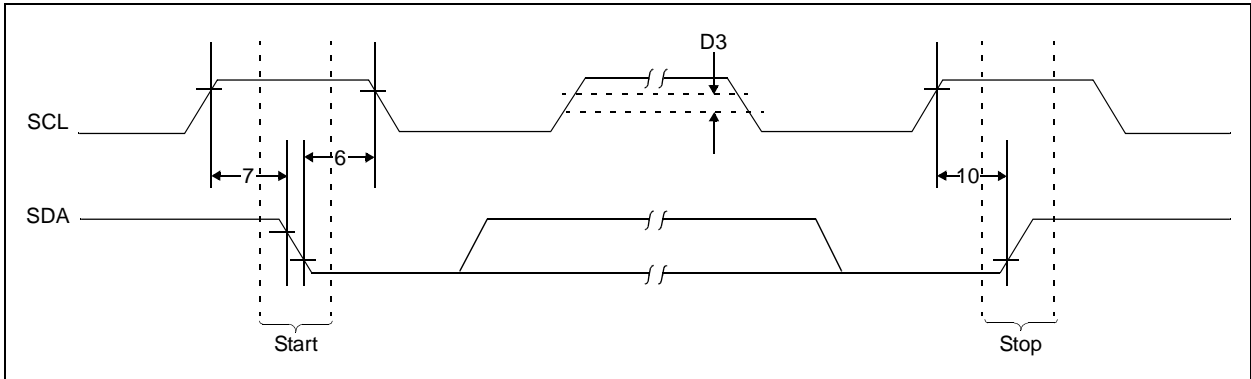

FIGURE 1-2: BUS TIMING START/STOP



2.0 PIN DESCRIPTIONS

The descriptions of the pins are listed in [Table 2-1](#).

TABLE 2-1: PIN FUNCTION TABLE

Name	SOIC	5-Pin SOT-23	6-Pin SOT-23	Description
A0	1	—	5	Chip Address Input ⁽¹⁾
A1	2	—	4	Chip Address Input ⁽¹⁾
A2	3	—	—	Chip Address Input ⁽¹⁾
Vss	4	2	2	Ground
SDA	5	3	3	Serial Address/Data I/O
SCL	6	1	1	Serial Clock
NC	7	5	—	Not Connected
Vcc	8	4	6	+1.7V to 5.5V Power Supply

Note 1: Chip address inputs A0, A1 and A2 are not connected on the 24AA02E48/24AA02E64.

2.1 Serial Address/Data Input/Output (SDA)

SDA is a bidirectional pin used to transfer addresses and data into and out of the device. Since it is an open-drain terminal, the SDA bus requires a pull-up resistor to Vcc (typical 10 k Ω for 100 kHz, 2 k Ω for 400 kHz).

For normal data transfer, SDA is allowed to change only during SCL low. Changes during SCL high are reserved for indicating Start and Stop conditions.

2.2 Serial Clock (SCL)

The SCL input is used to synchronize the data transfer to and from the device.

2.3 A0, A1, A2 Chip Address Inputs

The A0, A1 and A2 pins are not used by the 24AA02E48/24AA02E64. They may be left floating or tied to either Vss or Vcc.

For the 24AA025E48/24AA025E64, the levels on the A0, A1 and A2 inputs are compared with the corresponding bits in the slave address. The chip is selected if the compare is true. For the 6-lead SOT-23 package, pin A2 is not connected and its corresponding bit in the slave address should always be set to '0'.

Up to eight 24AA025E48/24AA025E64 devices (four for the SOT-23 package) may be connected to the same bus by using different Chip Select bit combinations. These inputs must be connected to either Vss or Vcc.

3.0 FUNCTIONAL DESCRIPTION

The 24AA02XEXX supports a bidirectional, 2-wire bus and data transmission protocol. A device that sends data onto the bus is defined as transmitter, while a device receiving data is defined as a receiver. The bus has to be controlled by a master device which generates the Serial Clock (SCL), controls the bus access and generates the Start and Stop conditions, while the 24AA02XEXX works as slave. Both master and slave can operate as transmitter or receiver, but the master device determines which mode is activated.

4.0 BUS CHARACTERISTICS

The following **bus protocol** has been defined:

- Data transfer may be initiated only when the bus is not busy.
- During data transfer, the data line must remain stable whenever the clock line is high. Changes in the data line while the clock line is high will be interpreted as a Start or Stop condition.

Accordingly, the following bus conditions have been defined (Figure 4-1).

4.1 Bus Not Busy (A)

Both data and clock lines remain high.

4.2 Start Data Transfer (B)

A high-to-low transition of the SDA line while the clock (SCL) is high determines a Start condition. All commands must be preceded by a Start condition.

4.3 Stop Data Transfer (C)

A low-to-high transition of the SDA line while the clock (SCL) is high determines a Stop condition. All operations must be ended with a Stop condition.

4.4 Data Valid (D)

The state of the data line represents valid data when, after a Start condition, the data line is stable for the duration of the high period of the clock signal.

The data on the line must be changed during the low period of the clock signal. There is one clock pulse per bit of data.

Each data transfer is initiated with a Start condition and terminated with a Stop condition. The number of data bytes transferred between Start and Stop conditions is determined by the master device and is, theoretically, unlimited (although only the last sixteen will be stored when doing a write operation). When an overwrite does occur, it will replace data in a first-in first-out (FIFO) fashion.

4.5 Acknowledge

Each receiving device, when addressed, is obliged to generate an acknowledge after the reception of each byte. The master device must generate an extra clock pulse which is associated with this Acknowledge bit.

Note: The 24AA02XEXX does not generate any Acknowledge bits if an internal programming cycle is in progress.

The device that acknowledges has to pull down the SDA line during the acknowledge clock pulse in such a way that the SDA line is stable-low during the high period of the acknowledge related clock pulse. Of course, setup and hold times must be taken into account. During reads, a master must signal an end of data to the slave by not generating an Acknowledge bit on the last byte that has been clocked out of the slave. In this case, the slave (24AA02XEXX) will leave the data line high to enable the master to generate the Stop condition.

FIGURE 4-1: DATA TRANSFER SEQUENCE ON THE SERIAL BUS



5.0 DEVICE ADDRESSING

A control byte is the first byte received following the Start condition from the master device. The control byte consists of a four-bit control code. For the 24AA02EXXX, this is set as '1010' binary for read and write operations. For the 24AA02E48/24AA02E64 the next three bits of the control byte are "don't cares".

For the 24AA025E48/24AA025E64, the next three bits of the control byte are the Chip Select bits (A2, A1, A0). The Chip Select bits allow the use of up to eight 24AA025E48/24AA025E64 devices on the same bus and are used to select which device is accessed. The Chip Select bits in the control byte must correspond to the logic levels on the corresponding A2, A1 and A0 pins for the device to respond. These bits are in effect the three Most Significant bits of the word address.

For the 6-pin SOT-23 package, the A2 address pin is not available. During device addressing, the A2 Chip Select bit should be set to '0'.

The last bit of the control byte defines the operation to be performed. When set to '1', a read operation is selected. When set to '0', a write operation is selected. Following the Start condition, the 24AA02EXXX monitors the SDA bus, checking the device type identifier being transmitted and, upon a '1010' code, the slave device outputs an Acknowledge signal on the SDA line. Depending on the state of the R/W bit, the 24AA02EXXX will select a read or write operation.

Operation	Control Code	Chip Select	R/W
Read	1010	Chip Address	1
Write	1010	Chip Address	0

FIGURE 5-1: CONTROL BYTE ALLOCATION



5.1 Contiguous Addressing Across Multiple Devices

The Chip Select bits A2, A1 and A0 can be used to expand the contiguous address space for up to 16K bits by adding up to eight 24AA025E48/24AA025E64 devices on the same bus. In this case, software can use A0 of the **control byte** as address bit A8, A1 as address bit A9 and A2 as address bit A10. It is not possible to sequentially read across device boundaries.

For the SOT-23 package, up to four 24AA025E48/24AA025E64 devices can be added for up to 8K bits of address space. In this case, software can use A0 of the **control byte** as address bit A8, and A1 as address bit A9. It is not possible to sequentially read across device boundaries.

FIGURE 5-2: ADDRESS SEQUENCE BIT ASSIGNMENTS



6.0 WRITE OPERATION

6.1 Byte Write

Following the Start condition from the master, the device code (four bits), the chip address (three bits) and the R/W bit which is a logic-low, is placed onto the bus by the master transmitter. This indicates to the addressed slave receiver that a byte with a word address will follow once it has generated an Acknowledge bit during the ninth clock cycle. Therefore, the next byte transmitted by the master is the word address and will be written into the Address Pointer of the 24AA02XEXX. After receiving another Acknowledge signal from the 24AA02XEXX, the master device will transmit the data word to be written into the addressed memory location. The 24AA02XEXX acknowledges again and the master generates a Stop condition. This initiates the internal write cycle and, during this time, the 24AA02XEXX will not generate Acknowledge signals (Figure 6-1).

6.2 Page Write

The write control byte, word address and the first data byte are transmitted to the 24AA02XEXX in the same way as in a byte write. However, instead of generating a Stop condition, the master transmits up to eight data bytes to the 24AA02XEXX, which are temporarily stored in the on-chip page buffer and will be written into memory once the master has transmitted a Stop condition. Upon receipt of each word, the three lower-order Address Pointer bits (four for the 24AA025E48/24AA025E64) are internally incremented by one.

The higher-order five bits (four for the 24AA025E48/24AA025E64) of the word address remain constant. If the master should transmit more than eight words (16 for the 24AA025E48/24AA025E64) prior to generating the Stop condition, the address counter will roll over and the previously received data will be overwritten. As with the byte write operation, once the Stop condition is received an internal write cycle will begin (Figure 6-2).

Note: Page write operations are limited to writing bytes within a single physical page **regardless** of the number of bytes actually being written. Physical page boundaries start at addresses that are integer multiples of the page buffer size (or 'page size') and end at addresses that are integer multiples of [page size - 1]. If a page write command attempts to write across a physical page boundary, the result is that the data wraps around to the beginning of the current page (overwriting data previously stored there), instead of being written to the next page, as might be expected. It is therefore necessary for the application software to prevent page write operations that would attempt to cross a page boundary.

6.3 Write Protection

The upper half of the array (80h-FFh) is permanently write-protected. Write operations to this address range are inhibited. Read operations are not affected.

The remaining half of the array (00h-7Fh) can be written to and read from normally.

FIGURE 6-1: BYTE WRITE



FIGURE 6-2: PAGE WRITE



7.0 ACKNOWLEDGE POLLING

Since the device will not acknowledge during a write cycle, this can be used to determine when the cycle is complete (this feature can be used to maximize bus throughput). Once the Stop condition for a write command has been issued from the master, the device initiates the internally timed write cycle and ACK polling can then be initiated immediately. This involves the master sending a Start condition followed by the control byte for a write command ($R/\overline{W} = 0$). If the device is still busy with the write cycle, no ACK will be returned. If the cycle is complete, the device will return the ACK and the master can then proceed with the next read or write command. See [Figure 7-1](#) for a flow diagram of this operation.

FIGURE 7-1: ACKNOWLEDGE POLLING FLOW



8.0 READ OPERATION

Read operations are initiated in the same way as write operations, with the exception that the R/W bit of the slave address is set to '1'. There are three basic types of read operations: current address read, random read and sequential read.

8.1 Current Address Read

The 24AA02XEXX contains an address counter that maintains the address of the last word accessed, internally incremented by one. Therefore, if the previous access (either a read or write operation) was to address 'n', the next current address read operation would access data from address $n + 1$. Upon receipt of the slave address with R/W bit set to '1', the 24AA02XEXX issues an acknowledge and transmits the 8-bit data word. The master will not acknowledge the transfer, but generate a Stop condition, and the 24AA02XEXX discontinues transmission (Figure 8-1).

8.2 Random Read

Random read operations allow the master to access any memory location in a random manner. To perform this type of read operation, the word address must first be set. This is accomplished by sending the word address to the 24AA02XEXX as part of a write operation. Once the word address is sent, the master generates a Start condition following the acknowledge. This terminates the write operation, but not before the internal Address Pointer is set. The master then issues the control byte again, but with the R/W bit set to a '1'. The 24AA02XEXX will then issue an acknowledge and transmit the 8-bit data word. The master will not acknowledge the transfer, but generate a Stop condition, and the 24AA02XEXX will discontinue transmission (Figure 8-2).

8.3 Sequential Read

Sequential reads are initiated in the same way as a random read, except that once the 24AA02XEXX transmits the first data byte, the master issues an acknowledge as opposed to a Stop condition in a random read. This directs the 24AA02XEXX to transmit the next sequentially addressed 8-bit word (Figure 8-3).

To provide sequential reads, the 24AA02XEXX contains an internal Address Pointer that is incremented by one upon completion of each operation. This Address Pointer allows the entire memory contents to be serially read during one operation.

8.4 Noise Protection

The 24AA02XEXX employs a VCC threshold detector circuit which disables the internal erase/write logic if the VCC is below 1.5V at nominal conditions.

The SCL and SDA inputs have Schmitt Trigger and filter circuits which suppress noise spikes to assure proper device operation, even on a noisy bus.

FIGURE 8-1: CURRENT ADDRESS READ



FIGURE 8-2: RANDOM READ



FIGURE 8-3: SEQUENTIAL READ



9.0 PRE-PROGRAMMED EUI-48™ OR EUI-64™ NODE ADDRESS

The 24AA02EXXX is programmed at the factory with a globally unique node address stored in the upper half of the array and permanently write-protected. The remaining 1,024 bits are available for application use.

FIGURE 9-1: MEMORY ORGANIZATION



9.1 EUI-48™ Node Address (24AAXXE48)

The 6-byte EUI-48™ node address value of the 24AAXXE48 is stored in array locations 0xFA through 0xFF, as shown in Figure 9-2. The first three bytes are the Organizationally Unique Identifier (OUI) assigned to Microchip by the IEEE Registration Authority. The remaining three bytes are the Extension Identifier, and are generated by Microchip to ensure a globally unique, 48-bit value.

FIGURE 9-2: EUI-48 NODE ADDRESS PHYSICAL MEMORY MAP EXAMPLE (24AAXXE48)

Description	24-bit Organizationally Unique Identifier			24-bit Extension Identifier		
	Data	00h	04h	A3h	12h	34h
Array Address	FAh			FFh		
Corresponding EUI-48™ Node Address: 00-04-A3-12-34-56						
Corresponding EUI-64™ Node Address After Encapsulation: 00-04-A3-FF-FE-12-34-56						

9.1.1 ORGANIZATIONALLY UNIQUE IDENTIFIERS (OUIs)

Each OUI provides roughly 16M (2^{24}) addresses. Once the address pool for an OUI is exhausted, Microchip will acquire a new OUI from IEEE to use for programming this model. For more information on past and current OUIs see "Organizationally Unique Identifiers For Preprogrammed EUI-48 and EUI-64 Address Devices" Technical Brief (DS90003187).

Note: The OUI will change as addresses are exhausted. Customers are not guaranteed to receive a specific OUI and should design their application to accept new OUIs as they are introduced.

9.1.2 EUI-64™ SUPPORT USING THE 24AAXXE48

The pre-programmed EUI-48 node address of the 24AAXXE48 can easily be encapsulated at the application level to form a globally unique, 64-bit node address for systems utilizing the EUI-64 standard. This is done by adding 0xFFFE between the OUI and the Extension Identifier, as shown below.

Note: As an alternative, the 24AAXXE64 features an EUI-64 node address that can be used in EUI-64 applications directly without the need for encapsulation, thereby simplifying system software. See Section 9.2 "EUI-64™ Node Address (24AAXXE64)" for details.

9.2 EUI-64™ Node Address (24AAXXE64)

The 8-byte EUI-64™ node address value of the 24AAXXE64 is stored in array locations 0xF8 through 0xFF, as shown in [Figure 9-3](#). The first three bytes are the Organizationally Unique Identifier (OUI) assigned to Microchip by the IEEE Registration Authority. The remaining five bytes are the Extension Identifier, and are generated by Microchip to ensure a globally unique, 64-bit value.

Note: In conformance with IEEE guidelines, Microchip will not use the values 0xFFFFE and 0xFFFF for the first two bytes of the EUI-64 Extension Identifier. These two values are specifically reserved to allow applications to encapsulate EUI-48 addresses into EUI-64 addresses.

FIGURE 9-3: EUI-64 NODE ADDRESS PHYSICAL MEMORY MAP EXAMPLE (24AAXXE64)

Description	24-bit Organizationally Unique Identifier			40-bit Extension Identifier					
	Data	00h	04h	A3h	12h	34h	56h	78h	90h
Array Address	F8h								FFh

Corresponding EUI-64™ Node Address: 00-04-A3-12-34-56-78-90

10.0 PACKAGING INFORMATION

10.1 Package Marking Information

8-Lead SOIC (3.90 mm)



Example



5-Lead SOT-23 (1-Line Marking)



Example



6-Lead SOT-23 (1-Line Marking)

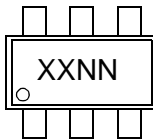

Example

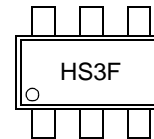

5-Lead SOT-23 (2-Line Marking)



Example



6-Lead SOT-23 (2-Line Marking)

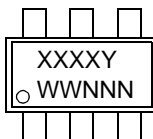

Example

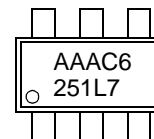

Part Number	1st Line Marking Code			
	SOT-23		SOIC	
	I-Temp.	E-Temp.	I-Temp.	E-Temp.
24AA02E48	2KNN ^(1,2)	AABLY ⁽³⁾	24A2E48I	24A2E48E
24AA025E48	HSNN ^(1,2)	AABMY ⁽³⁾	4A25E48I	4A25E48E
24AA02E64	AAABY ⁽³⁾	AABNY ⁽³⁾	24A2E64I	24A2E64E
24AA025E64	AAACY ⁽³⁾	AABPY ⁽³⁾	4A25E64I	4A25E64E

Note 1: NN = Alphanumeric traceability code

2: These parts use the 1-line SOT-23 marking format

3: These parts use the 2-line SOT-23 marking format

Legend:	XX...X	Part number or part number code
	T	Temperature (I, E)
	Y	Year code (last digit of calendar year)
	YY	Year code (last 2 digits of calendar year)
	WW	Week code (week of January 1 is week '01')
	NNN	Alphanumeric traceability code (2 characters for small packages)
	ⓔ3	JEDEC® designator for Matte Tin (Sn)

*Standard OTP marking consists of Microchip part number, year code, week code, and traceability code.

Note: For very small packages with no room for the JEDEC® designator ⓔ3, the marking will only appear on the outer carton or reel label.

Note: In the event the full Microchip part number cannot be marked on one line, it will be carried over to the next line, thus limiting the number of available characters for customer-specific information.

8-Lead Plastic Small Outline (SN) - Narrow, 3.90 mm (.150 In.) Body [SOIC]

Note: For the most current package drawings, please see the Microchip Packaging Specification located at <http://www.microchip.com/packaging>



Microchip Technology Drawing No. C04-057-SN Rev D Sheet 1 of 2

24AA02E48/24AA025E48/24AA02E64/24AA025E64

8-Lead Plastic Small Outline (SN) - Narrow, 3.90 mm (.150 In.) Body [SOIC]

Note: For the most current package drawings, please see the Microchip Packaging Specification located at <http://www.microchip.com/packaging>



Dimension Limits	Units	MILLIMETERS		
		MIN	NOM	MAX
Number of Pins	N	8		
Pitch	e	1.27 BSC		
Overall Height	A	-	-	1.75
Molded Package Thickness	A2	1.25	-	-
Standoff §	A1	0.10	-	0.25
Overall Width	E	6.00 BSC		
Molded Package Width	E1	3.90 BSC		
Overall Length	D	4.90 BSC		
Chamfer (Optional)	h	0.25	-	0.50
Foot Length	L	0.40	-	1.27
Footprint	L1	1.04 REF		
Foot Angle	φ	0°	-	8°
Lead Thickness	c	0.17	-	0.25
Lead Width	b	0.31	-	0.51
Mold Draft Angle Top	α	5°	-	15°
Mold Draft Angle Bottom	β	5°	-	15°

Notes:

1. Pin 1 visual index feature may vary, but must be located within the hatched area.
2. § Significant Characteristic
3. Dimensions D and E1 do not include mold flash or protrusions. Mold flash or protrusions shall not exceed 0.15mm per side.
4. Dimensioning and tolerancing per ASME Y14.5M
BSC: Basic Dimension. Theoretically exact value shown without tolerances.
REF: Reference Dimension, usually without tolerance, for information purposes only.
5. Datums A & B to be determined at Datum H.

Microchip Technology Drawing No. C04-057-SN Rev D Sheet 2 of 2

8-Lead Plastic Small Outline (SN) - Narrow, 3.90 mm Body [SOIC]

Note: For the most current package drawings, please see the Microchip Packaging Specification located at <http://www.microchip.com/packaging>



RECOMMENDED LAND PATTERN

Dimension Limits	Units	MILLIMETERS		
		MIN	NOM	MAX
Contact Pitch	E	1.27 BSC		
Contact Pad Spacing	C		5.40	
Contact Pad Width (X8)	X1			0.60
Contact Pad Length (X8)	Y1			1.55

Notes:

- Dimensioning and tolerancing per ASME Y14.5M
BSC: Basic Dimension. Theoretically exact value shown without tolerances.

Microchip Technology Drawing C04-2057-SN Rev B

5-Lead Plastic Small Outline Transistor (OT) [SOT23]

Note: For the most current package drawings, please see the Microchip Packaging Specification located at <http://www.microchip.com/packaging>



5-Lead Plastic Small Outline Transistor (OT) [SOT23]

Note: For the most current package drawings, please see the Microchip Packaging Specification located at <http://www.microchip.com/packaging>



VIEW A-A
SHEET 1

Dimension Limits	Units	MILLIMETERS		
		MIN	NOM	MAX
Number of Pins	N	6		
Pitch	e	0.95 BSC		
Outside lead pitch	e1	1.90 BSC		
Overall Height	A	0.90	-	1.45
Molded Package Thickness	A2	0.89	-	1.30
Standoff	A1	-	-	0.15
Overall Width	E	2.80 BSC		
Molded Package Width	E1	1.60 BSC		
Overall Length	D	2.90 BSC		
Foot Length	L	0.30	-	0.60
Footprint	L1	0.60 REF		
Foot Angle	φ	0°	-	10°
Lead Thickness	c	0.08	-	0.26
Lead Width	b	0.20	-	0.51

Notes:

- Dimensions D and E1 do not include mold flash or protrusions. Mold flash or protrusions shall not exceed 0.25mm per side.
- Dimensioning and tolerancing per ASME Y14.5M
 BSC: Basic Dimension. Theoretically exact value shown without tolerances.
 REF: Reference Dimension, usually without tolerance, for information purposes only.

Microchip Technology Drawing C04-091D [OT] Sheet 2 of 2

5-Lead Plastic Small Outline Transistor (OT) [SOT23]

Note: For the most current package drawings, please see the Microchip Packaging Specification located at <http://www.microchip.com/packaging>



RECOMMENDED LAND PATTERN

Dimension Limits	Units	MILLIMETERS		
		MIN	NOM	MAX
Contact Pitch	E		0.95 BSC	
Contact Pad Spacing	C		2.80	
Contact Pad Width (X5)	X			0.60
Contact Pad Length (X5)	Y			1.10
Distance Between Pads	G	1.70		
Distance Between Pads	GX	0.35		
Overall Width	Z			3.90

Notes:

1. Dimensioning and tolerancing per ASME Y14.5M

BSC: Basic Dimension. Theoretically exact value shown without tolerances.

Microchip Technology Drawing No. C04-2091A [OT]

6-Lead Plastic Small Outline Transistor (OT, OTY) [SOT-23]

Note: For the most current package drawings, please see the Microchip Packaging Specification located at <http://www.microchip.com/packaging>



Microchip Technology Drawing C04-028C (OT) Sheet 1 of 2

6-Lead Plastic Small Outline Transistor (OT, OTY) [SOT-23]

Note: For the most current package drawings, please see the Microchip Packaging Specification located at <http://www.microchip.com/packaging>



Dimension Limits	Units	MILLIMETERS		
		MIN	NOM	MAX
Number of Leads	N	6		
Pitch	e	0.95 BSC		
Outside lead pitch	e1	1.90 BSC		
Overall Height	A	0.90	-	1.45
Molded Package Thickness	A2	0.89	1.15	1.30
Standoff	A1	0.00	-	0.15
Overall Width	E	2.80 BSC		
Molded Package Width	E1	1.60 BSC		
Overall Length	D	2.90 BSC		
Foot Length	L	0.30	0.45	0.60
Footprint	L1	0.60 REF		
Seating Plane to Gauge Plane	L1	0.25 BSC		
Foot Angle	ϕ	0°	-	10°
Lead Thickness	c	0.08	-	0.26
Lead Width	b	0.20	-	0.51

Notes:

- Dimensions D and E1 do not include mold flash or protrusions. Mold flash or protrusions shall not exceed 0.25mm per side.
- Dimensioning and tolerancing per ASME Y14.5M
 BSC: Basic Dimension. Theoretically exact value shown without tolerances.
 REF: Reference Dimension, usually without tolerance, for information purposes only.

Microchip Technology Drawing C04-028C (OT) Sheet 2 of 2

6-Lead Plastic Small Outline Transistor (OT, OTY) [SOT-23]

Note: For the most current package drawings, please see the Microchip Packaging Specification located at <http://www.microchip.com/packaging>



RECOMMENDED LAND PATTERN

Dimension Limits	Units	MILLIMETERS		
		MIN	NOM	MAX
Contact Pitch	E	0.95 BSC		
Contact Pad Spacing	C		2.80	
Contact Pad Width (X3)	X			0.60
Contact Pad Length (X3)	Y			1.10
Distance Between Pads	G	1.70		
Distance Between Pads	GX	0.35		
Overall Width	Z			3.90

Notes:

1. Dimensioning and tolerancing per ASME Y14.5M

BSC: Basic Dimension. Theoretically exact value shown without tolerances.

Microchip Technology Drawing No. C04-2028B (OT)

APPENDIX A: REVISION HISTORY

Revision A (12/08)

Initial release of this document.

Revision B (01/09)

Removed preliminary status.

Revision C (03/10)

Added new sections 2.0 through 9.0.

Revision D (05/10)

Added 24AA025E48 part number and 6-lead SOT-23 package.

Revision E (04/13)

Added 24AA02E64 and 24AA025E64 part numbers.

Revision F (10/14)

Added E-temp. option to part numbers.

Revision G (08/16)

Added new OUI (54-10-EC) to list.

Revision H (02/18)

Added detailed description of OUIs.

NOTES:

THE MICROCHIP WEBSITE

Microchip provides online support via our website at www.microchip.com. This website is used as a means to make files and information easily available to customers. Accessible by using your favorite Internet browser, the website contains the following information:

- **Product Support** – Data sheets and errata, application notes and sample programs, design resources, user's guides and hardware support documents, latest software releases and archived software
- **General Technical Support** – Frequently Asked Questions (FAQ), technical support requests, online discussion groups, Microchip consultant program member listing
- **Business of Microchip** – Product selector and ordering guides, latest Microchip press releases, listing of seminars and events, listings of Microchip sales offices, distributors and factory representatives

CUSTOMER CHANGE NOTIFICATION SERVICE

Microchip's customer notification service helps keep customers current on Microchip products. Subscribers will receive e-mail notification whenever there are changes, updates, revisions or errata related to a specified product family or development tool of interest.

To register, access the Microchip website at www.microchip.com. Under "Support", click on "Customer Change Notification" and follow the registration instructions.

CUSTOMER SUPPORT

Users of Microchip products can receive assistance through several channels:

- Distributor or Representative
- Local Sales Office
- Field Application Engineer (FAE)
- Technical Support

Customers should contact their distributor, representative or Field Application Engineer (FAE) for support. Local sales offices are also available to help customers. A listing of sales offices and locations is included in the back of this document.

Technical support is available through the website at: <http://microchip.com/support>

NOTES:

PRODUCT IDENTIFICATION SYSTEM

To order or obtain information, e.g., on pricing or delivery, refer to the factory or the listed sales office.

<u>PART NO.</u>	<u>IXI⁽¹⁾</u>	<u>X</u>	<u>IXX</u>	
Device	Tape and Reel Option	Temperature Range	Package	
Device:	24AA02E48	=	1.7V, 2 Kbit I ² C Serial EEPROM with EUI-48™ Node Identity	Examples: a) 24AA02E48-I/SN: 2 Kbit, 8-byte page, Serial EEPROM with EUI-48 Node Identity, 1.7V, Industrial Temperature, SOIC package. b) 24AA02E48T-I/OT: 2 Kbit, 8-byte page, Serial EEPROM with EUI-48 Node Identity, 1.7V, Tape and Reel, Industrial Temperature, SOT-23 package. c) 24AA025E48-I/SN: 2 Kbit, 16-byte page, Serial EEPROM with EUI-48 Node Identity, X, 1.7V, Cascadable, Industrial Temperature, SOIC package. d) 24AA02E64-I/SN: 2 Kbit, 8-byte page, Serial EEPROM with EUI-64 Node Identity, 1.7V, Industrial Temperature, SOIC package. e) 24AA02E64T-I/OT: 2 Kbit, 8-byte page, Serial EEPROM with EUI-64 Node Identity, 1.7V, Tape and Reel, Industrial Temperature, SOT-23 package. f) 24AA025E64-I/SN: 2 Kbit, 16-byte page, Serial EEPROM with EUI-64 Node Identity, 1.7V, Cascadable, Industrial Temperature, SOIC package. g) 24AA025E48T-E/SN: 2 Kbit, 16-byte page, Serial EEPROM with EUI-48 Node Identity, 1.7V, Cascadable, Tape and Reel, Automotive Temperature, SOIC package. h) 24AA02E48-E/SN: 2 Kbit, 8-byte page, Serial EEPROM with EUI-48 Node Identity, 1.7V, Automotive Temperature, SOIC package. i) 24AA025E48T-E/OT: 2 Kbit, 16-byte page, Serial EEPROM with EUI-48 Node Identity, 1.7V, Cascadable, Tape and Reel, Automotive Temperature, SOT-23 package.
	24AA025E48	=	1.7V, 2 Kbit I ² C Serial EEPROM with EUI-48™ Node Identity and Address Pins	
	24AA02E64	=	1.7V, 2 Kbit I ² C Serial EEPROM with EUI-64™ Node Identity	
	24AA025E64	=	1.7V, 2 Kbit I ² C Serial EEPROM with EUI-64™ Node Identity and Address Pins	
Tape and Reel Option:	Blank	=	Standard packaging (tube or tray)	
	T	=	Tape and Reel ⁽¹⁾	
Temperature Range:	I	=	-40°C to +85°C	
	E	=	-40°C to +125°C	
Package:	SN	=	Plastic SOIC (3.90 mm body), 8-lead	
	OT	=	SOT-23 (Tape and Reel only)	
				Note 1: Tape and Reel identifier only appears in the catalog part number description. This identifier is used for ordering purposes and is not printed on the device package. Check with your Microchip Sales Office for package availability with the Tape and Reel option.

NOTES:

Note the following details of the code protection feature on Microchip devices:

- Microchip products meet the specification contained in their particular Microchip Data Sheet.
- Microchip believes that its family of products is one of the most secure families of its kind on the market today, when used in the intended manner and under normal conditions.
- There are dishonest and possibly illegal methods used to breach the code protection feature. All of these methods, to our knowledge, require using the Microchip products in a manner outside the operating specifications contained in Microchip's Data Sheets. Most likely, the person doing so is engaged in theft of intellectual property.
- Microchip is willing to work with the customer who is concerned about the integrity of their code.
- Neither Microchip nor any other semiconductor manufacturer can guarantee the security of their code. Code protection does not mean that we are guaranteeing the product as “unbreakable.”

Code protection is constantly evolving. We at Microchip are committed to continuously improving the code protection features of our products. Attempts to break Microchip's code protection feature may be a violation of the Digital Millennium Copyright Act. If such acts allow unauthorized access to your software or other copyrighted work, you may have a right to sue for relief under that Act.

Information contained in this publication regarding device applications and the like is provided only for your convenience and may be superseded by updates. It is your responsibility to ensure that your application meets with your specifications. MICROCHIP MAKES NO REPRESENTATIONS OR WARRANTIES OF ANY KIND WHETHER EXPRESS OR IMPLIED, WRITTEN OR ORAL, STATUTORY OR OTHERWISE, RELATED TO THE INFORMATION, INCLUDING BUT NOT LIMITED TO ITS CONDITION, QUALITY, PERFORMANCE, MERCHANTABILITY OR FITNESS FOR PURPOSE. Microchip disclaims all liability arising from this information and its use. Use of Microchip devices in life support and/or safety applications is entirely at the buyer's risk, and the buyer agrees to defend, indemnify and hold harmless Microchip from any and all damages, claims, suits, or expenses resulting from such use. No licenses are conveyed, implicitly or otherwise, under any Microchip intellectual property rights unless otherwise stated.

Microchip received ISO/TS-16949:2009 certification for its worldwide headquarters, design and wafer fabrication facilities in Chandler and Tempe, Arizona; Gresham, Oregon and design centers in California and India. The Company's quality system processes and procedures are for its PIC® MCUs and dsPIC® DSCs, KEELoQ® code hopping devices, Serial EEPROMs, microperipherals, nonvolatile memory and analog products. In addition, Microchip's quality system for the design and manufacture of development systems is ISO 9001:2000 certified.

**QUALITY MANAGEMENT SYSTEM
CERTIFIED BY DNV
= ISO/TS 16949 =**

Trademarks

The Microchip name and logo, the Microchip logo, AnyRate, AVR, AVR logo, AVR Freaks, BeaconThings, BitCloud, chipKIT, chipKIT logo, CryptoMemory, CryptoRF, dsPIC, FlashFlex, flexPWR, Heldo, JukeBlox, KEELoQ, KEELoQ logo, Kleer, LANCheck, LINK MD, maXStylus, maXTouch, MedialB, megaAVR, MOST, MOST logo, MPLAB, OptoLyzer, PIC, picoPower, PICSTART, PIC32 logo, Prochip Designer, QTouch, RightTouch, SAM-BA, SpyNIC, SST, SST Logo, SuperFlash, tinyAVR, UNI/O, and XMEGA are registered trademarks of Microchip Technology Incorporated in the U.S.A. and other countries.

ClockWorks, The Embedded Control Solutions Company, EtherSynch, Hyper Speed Control, HyperLight Load, IntelliMOS, mTouch, Precision Edge, and Quiet-Wire are registered trademarks of Microchip Technology Incorporated in the U.S.A.

Adjacent Key Suppression, AKS, Analog-for-the-Digital Age, Any Capacitor, AnyIn, AnyOut, BodyCom, CodeGuard, CryptoAuthentication, CryptoCompanion, CryptoController, dsPICDEM, dsPICDEM.net, Dynamic Average Matching, DAM, ECAN, EtherGREEN, In-Circuit Serial Programming, ICSP, Inter-Chip Connectivity, JitterBlocker, KleerNet, KleerNet logo, Mindi, MiWi, motorBench, MPASM, MPF, MPLAB Certified logo, MPLIB, MPLINK, MultiTRAK, NetDetach, Omniscient Code Generation, PICDEM, PICDEM.net, PICKit, PICTail, PureSilicon, QMatrix, RightTouch logo, REAL ICE, Ripple Blocker, SAM-ICE, Serial Quad I/O, SMART-I.S., SQI, SuperSwitcher, SuperSwitcher II, Total Endurance, TSHARC, USBCheck, VariSense, ViewSpan, WiperLock, Wireless DNA, and ZENA are trademarks of Microchip Technology Incorporated in the U.S.A. and other countries.

SQTP is a service mark of Microchip Technology Incorporated in the U.S.A.

Silicon Storage Technology is a registered trademark of Microchip Technology Inc. in other countries.

GestIC is a registered trademark of Microchip Technology Germany II GmbH & Co. KG, a subsidiary of Microchip Technology Inc., in other countries.

All other trademarks mentioned herein are property of their respective companies.

© 2008-2018, Microchip Technology Incorporated, All Rights Reserved.

ISBN: 978-1-5224-2735-3



MICROCHIP

Worldwide Sales and Service

AMERICAS

Corporate Office
2355 West Chandler Blvd.
Chandler, AZ 85224-6199
Tel: 480-792-7200
Fax: 480-792-7277
Technical Support:
<http://www.microchip.com/support>
Web Address:
www.microchip.com

Atlanta

Duluth, GA
Tel: 678-957-9614
Fax: 678-957-1455

Austin, TX

Tel: 512-257-3370

Boston

Westborough, MA
Tel: 774-760-0087
Fax: 774-760-0088

Chicago

Itasca, IL
Tel: 630-285-0071
Fax: 630-285-0075

Dallas

Addison, TX
Tel: 972-818-7423
Fax: 972-818-2924

Detroit

Novi, MI
Tel: 248-848-4000

Houston, TX

Tel: 281-894-5983

Indianapolis

Noblesville, IN
Tel: 317-773-8323
Fax: 317-773-5453
Tel: 317-536-2380

Los Angeles

Mission Viejo, CA
Tel: 949-462-9523
Fax: 949-462-9608
Tel: 951-273-7800

Raleigh, NC

Tel: 919-844-7510

New York, NY

Tel: 631-435-6000

San Jose, CA

Tel: 408-735-9110
Tel: 408-436-4270

Canada - Toronto

Tel: 905-695-1980
Fax: 905-695-2078

ASIA/PACIFIC

Australia - Sydney
Tel: 61-2-9868-6733

China - Beijing
Tel: 86-10-8569-7000

China - Chengdu
Tel: 86-28-8665-5511

China - Chongqing
Tel: 86-23-8980-9588

China - Dongguan
Tel: 86-769-8702-9880

China - Guangzhou
Tel: 86-20-8755-8029

China - Hangzhou
Tel: 86-571-8792-8115

China - Hong Kong SAR
Tel: 852-2943-5100

China - Nanjing
Tel: 86-25-8473-2460

China - Qingdao
Tel: 86-532-8502-7355

China - Shanghai
Tel: 86-21-3326-8000

China - Shenyang
Tel: 86-24-2334-2829

China - Shenzhen
Tel: 86-755-8864-2200

China - Suzhou
Tel: 86-186-6233-1526

China - Wuhan
Tel: 86-27-5980-5300

China - Xian
Tel: 86-29-8833-7252

China - Xiamen
Tel: 86-592-2388138

China - Zhuhai
Tel: 86-756-3210040

ASIA/PACIFIC

India - Bangalore
Tel: 91-80-3090-4444

India - New Delhi
Tel: 91-11-4160-8631

India - Pune
Tel: 91-20-4121-0141

Japan - Osaka
Tel: 81-6-6152-7160

Japan - Tokyo
Tel: 81-3-6880-3770

Korea - Daegu
Tel: 82-53-744-4301

Korea - Seoul
Tel: 82-2-554-7200

Malaysia - Kuala Lumpur
Tel: 60-3-7651-7906

Malaysia - Penang
Tel: 60-4-227-8870

Philippines - Manila
Tel: 63-2-634-9065

Singapore
Tel: 65-6334-8870

Taiwan - Hsin Chu
Tel: 886-3-577-8366

Taiwan - Kaohsiung
Tel: 886-7-213-7830

Taiwan - Taipei
Tel: 886-2-2508-8600

Thailand - Bangkok
Tel: 66-2-694-1351

Vietnam - Ho Chi Minh
Tel: 84-28-5448-2100

EUROPE

Austria - Wels
Tel: 43-7242-2244-39
Fax: 43-7242-2244-393

Denmark - Copenhagen
Tel: 45-4450-2828
Fax: 45-4485-2829

Finland - Espoo
Tel: 358-9-4520-820

France - Paris
Tel: 33-1-69-53-63-20
Fax: 33-1-69-30-90-79

Germany - Garching
Tel: 49-8931-9700

Germany - Haan
Tel: 49-2129-3766400

Germany - Heilbronn
Tel: 49-7131-67-3636

Germany - Karlsruhe
Tel: 49-721-625370

Germany - Munich
Tel: 49-89-627-144-0
Fax: 49-89-627-144-44

Germany - Rosenheim
Tel: 49-8031-354-560

Israel - Ra'anana
Tel: 972-9-744-7705

Italy - Milan
Tel: 39-0331-742611
Fax: 39-0331-466781

Italy - Padova
Tel: 39-049-7625286

Netherlands - Drunen
Tel: 31-416-690399
Fax: 31-416-690340

Norway - Trondheim
Tel: 47-7289-7561

Poland - Warsaw
Tel: 48-22-3325737

Romania - Bucharest
Tel: 40-21-407-87-50

Spain - Madrid
Tel: 34-91-708-08-90
Fax: 34-91-708-08-91

Sweden - Gothenberg
Tel: 46-31-704-60-40

Sweden - Stockholm
Tel: 46-8-5090-4654

UK - Wokingham
Tel: 44-118-921-5800
Fax: 44-118-921-5820

Mouser Electronics

Authorized Distributor

Click to View Pricing, Inventory, Delivery & Lifecycle Information:

Microchip:

[24AA02E48-I/SN](#) [24AA02E48T-I/SN](#) [24AA02E48T-I/OT](#) [24AA025E48-I/SN](#) [24AA025E48T-I/OT](#) [24AA025E48T-I/SN](#)
[24AA025E64-I/SN](#) [24AA025E64T-I/OT](#) [24AA025E64T-I/SN](#) [24AA02E64-I/SN](#) [24AA02E64T-I/OT](#) [24AA02E64T-I/SN](#)
[24AA025E48T-E/OT](#) [24AA02E64T-E/SN](#) [24AA025E64T-E/OT](#) [24AA025E48T-E/SN](#) [24AA02E64-E/SN](#)
[24AA025E64-E/SN](#) [24AA02E48T-E/SN](#) [24AA02E64T-E/OT](#) [24AA02E48T-E/OT](#) [24AA025E64T-E/SN](#) [24AA02E48-](#)
[E/SN](#) [24AA025E48-E/SN](#)



Компания «ЭлектроПласт» предлагает заключение долгосрочных отношений при поставках импортных электронных компонентов на взаимовыгодных условиях!

Наши преимущества:

- Оперативные поставки широкого спектра электронных компонентов отечественного и импортного производства напрямую от производителей и с крупнейших мировых складов;
- Поставка более 17-ти миллионов наименований электронных компонентов;
- Поставка сложных, дефицитных, либо снятых с производства позиций;
- Оперативные сроки поставки под заказ (от 5 рабочих дней);
- Экспресс доставка в любую точку России;
- Техническая поддержка проекта, помощь в подборе аналогов, поставка прототипов;
- Система менеджмента качества сертифицирована по Международному стандарту ISO 9001;
- Лицензия ФСБ на осуществление работ с использованием сведений, составляющих государственную тайну;
- Поставка специализированных компонентов (Xilinx, Altera, Analog Devices, Intersil, Interpoint, Microsemi, Aeroflex, Peregrine, Syfer, Eurofarad, Texas Instrument, Miteq, Cobham, E2V, MA-COM, Hittite, Mini-Circuits, General Dynamics и др.);

Помимо этого, одним из направлений компании «ЭлектроПласт» является направление «Источники питания». Мы предлагаем Вам помощь Конструкторского отдела:

- Подбор оптимального решения, техническое обоснование при выборе компонента;
- Подбор аналогов;
- Консультации по применению компонента;
- Поставка образцов и прототипов;
- Техническая поддержка проекта;
- Защита от снятия компонента с производства.



Как с нами связаться

Телефон: 8 (812) 309 58 32 (многоканальный)

Факс: 8 (812) 320-02-42

Электронная почта: org@eplast1.ru

Адрес: 198099, г. Санкт-Петербург, ул. Калинина, дом 2, корпус 4, литера А.