



## GaAs PHEMT MMIC MODULATOR DRIVER AMPLIFIER, DC - 20 GHz

### Typical Applications

The HMC465LP5(E) wideband driver is ideal for:

- OC192 LN/MZ Modulator Driver
- Microwave Radio & VSAT
- Test Instrumentation
- Military EW, ECM & C<sup>3</sup>I

### Features

- Gain: 15 dB
- Output Voltage to 10Vpk-pk
- +24 dBm Saturated Output Power
- Supply Voltage: +8V @160 mA
- 50 Ohm Matched Input/Output
- 32 Lead 5x5 mm QFN Package: 25 mm<sup>2</sup>

### Functional Diagram

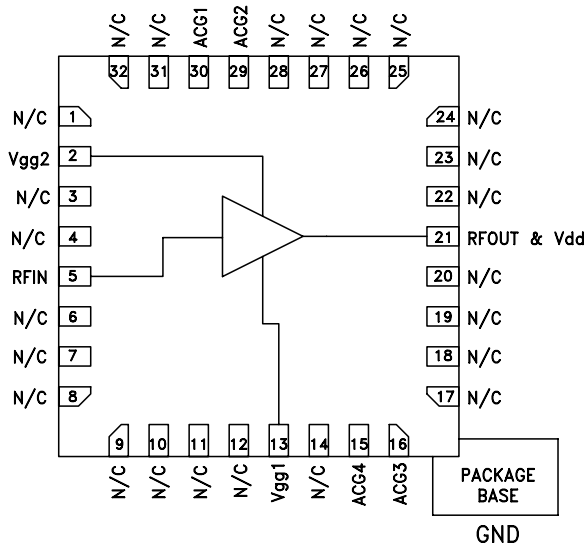

### General Description

The HMC465LP5(E) is a GaAs MMIC PHEMT Distributed Driver Amplifier packaged in leadless 5x5 mm surface mount package which operate between DC and 20 GHz. The amplifier provides 15 dB of gain, 3 dB noise figure and +25 dBm of saturated output power while requiring only 160 mA from a +8V supply. Gain flatness is excellent at ±0.5 dB as well as ±4 deg deviation from linear phase from DC - 10 GHz making the HMC465LP5(E) ideal for OC192 fiber optic LN/MZ modulator driver amplifiers as well as test equipment applications. The HMC465LP5(E) amplifiers I/Os are internally matched to 50 Ohms.

### Electrical Specifications, $T_A = +25^\circ C$ , $V_{dd} = 8V$ , $V_{gg2} = 1.5V$ , $I_{dd} = 160 mA^*$

Parameter	Min.	Typ.	Max.	Min.	Typ.	Max.	Min.	Typ.	Max.	Units
Frequency Range	DC - 6			6.0 - 12.0			12.0 - 20.0			GHz
Gain	13	16		12	15		9.5	12.5		dB
Gain Flatness		±0.75			±0.25			±1.5		dB
Gain Variation Over Temperature		0.015	0.02		0.020	0.025		0.035	0.045	dB/ °C
Noise Figure		3.0			3.0			4.0		dB
Input Return Loss		20			15			8		dB
Output Return Loss		22			17			12		dB
Output Power for 1 dB Compression (P1dB)	21	24		20	23		16	20		dBm
Saturated Output Power (Psat)		25.5			25			23		dBm
Output Third Order Intercept (IP3)		32			28			24		dBm
Saturated Output Voltage		10			10			8		Vpk-pk
Group Delay Variation		±15			±15					pSec
Supply Current (Idd) (Vdd= 8V, Vgg1= -0.6V Typ.)		160			160			160		mA

\* Adjust Vgg1 between -2 to 0V to achieve Idd= 160 mA typical.



**GAAS PHEMT MMIC MODULATOR DRIVER  
AMPLIFIER, DC - 20 GHz**

**Gain & Return Loss**

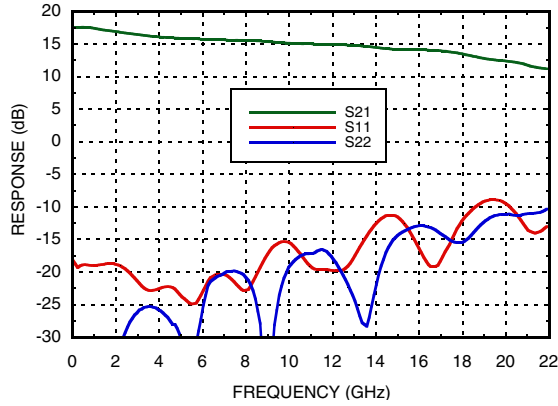

**Gain vs. Temperature**

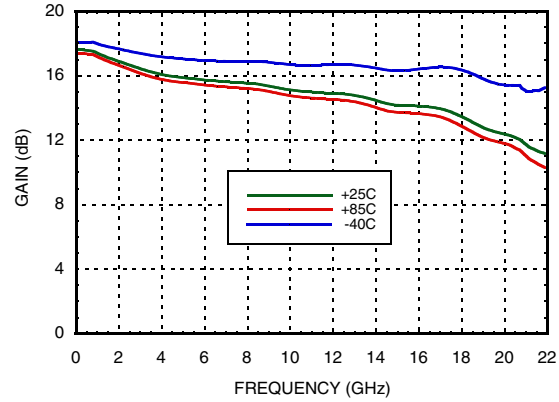

**Input Return Loss vs. Temperature**

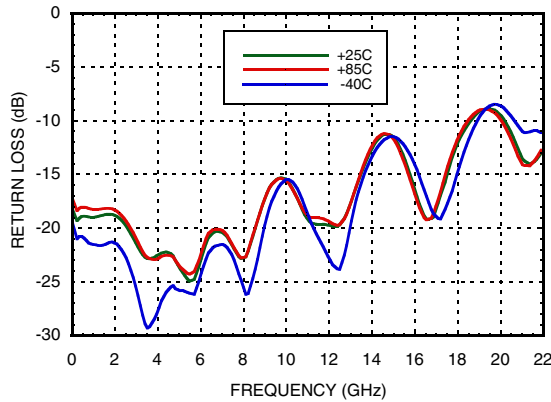

**Output Return Loss vs. Temperature**

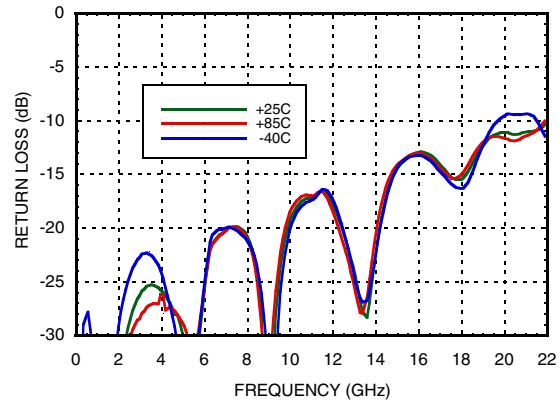

**Low Frequency Gain & Return Loss**

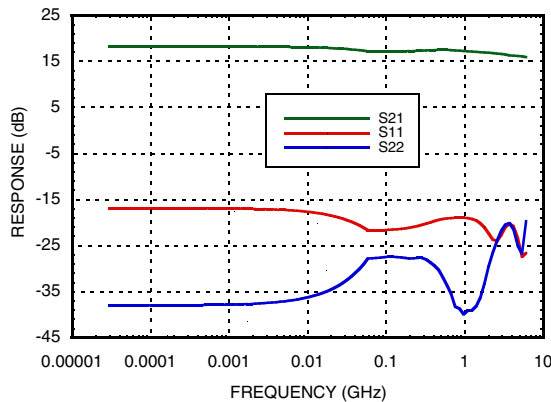

**Noise Figure vs. Temperature**

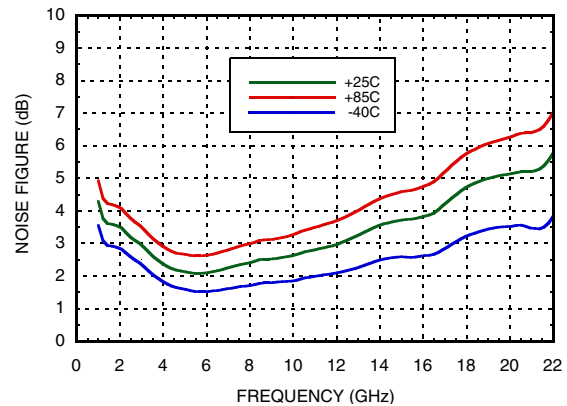



**GAAS PHEMT MMIC MODULATOR DRIVER AMPLIFIER, DC - 20 GHz**

AMPLIFIERS - DRIVER & GAIN BLOCK - SMT

**P1dB vs. Temperature**

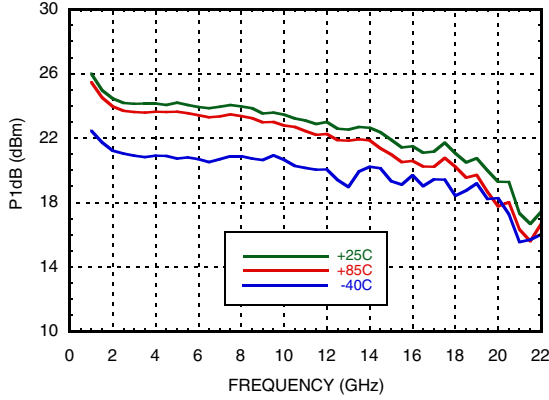

**Psat vs. Temperature**

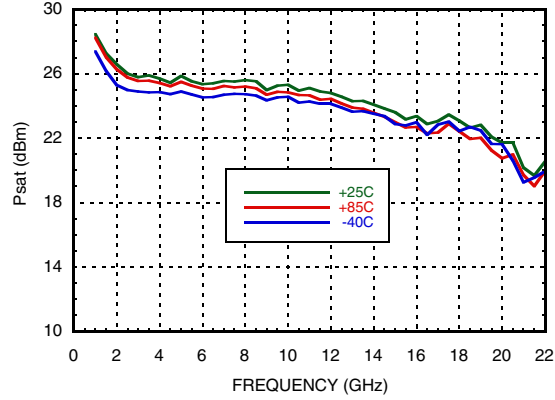

**Output IP3 vs. Temperature**

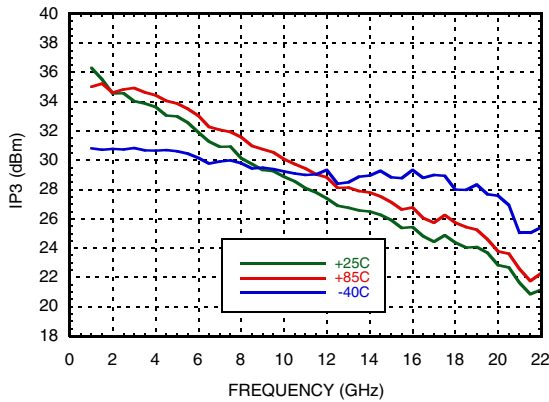

**Gain, Power & Output IP3 vs. Supply Voltage @ 10 GHz, I<sub>dd</sub> = 160mA**

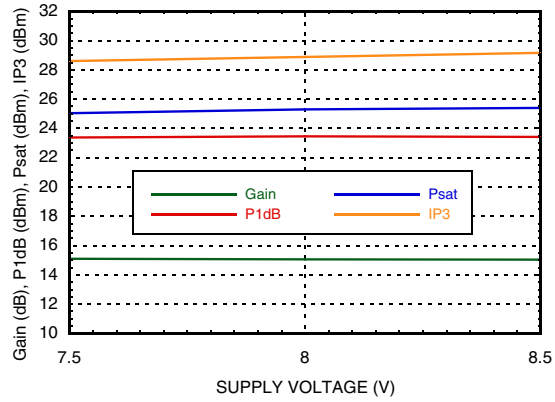

**Group Delay**

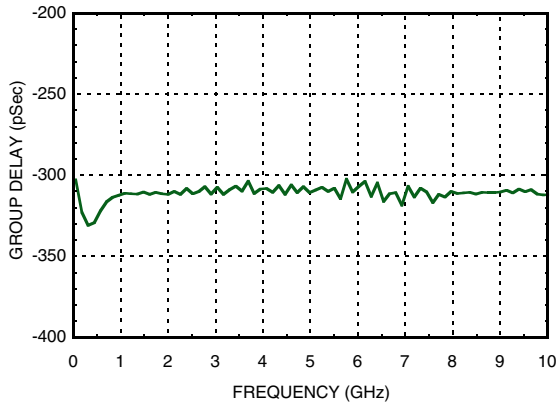

**Deviation from Linear Phase**

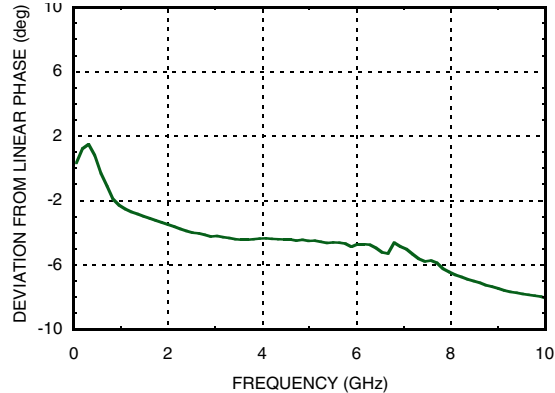



## GAAS PHEMT MMIC MODULATOR DRIVER AMPLIFIER, DC - 20 GHz

### Absolute Maximum Ratings

Drain Bias Voltage (Vdd)	+9 Vdc
Gate Bias Voltage (Vgg1)	-2 to 0 Vdc
Gate Bias Current (Igg1)	+3.2mA
Gate Bias Voltage (Vgg2)	(Vdd -8) Vdc to +3 Vdc
Gate Bias Current (Igg2)	+3.2mA
RF Input Power (RFIN)(Vdd = +8 Vdc)	+23 dBm
Channel Temperature	150 °C
Continuous Pdiss (T = 85 °C) (derate 24 mW/°C above 85 °C)	1.56 W
Thermal Resistance (channel to ground paddle)	41.5 °C/W
Storage Temperature	-65 to +150 °C
Operating Temperature	-40 to +85 °C

### Typical Supply Current vs. Vdd

Vdd (V)	Idd (mA)
+7.5	161
+8.0	160
+8.5	159



ELECTROSTATIC SENSITIVE DEVICE  
OBSERVE HANDLING PRECAUTIONS

### Outline Drawing

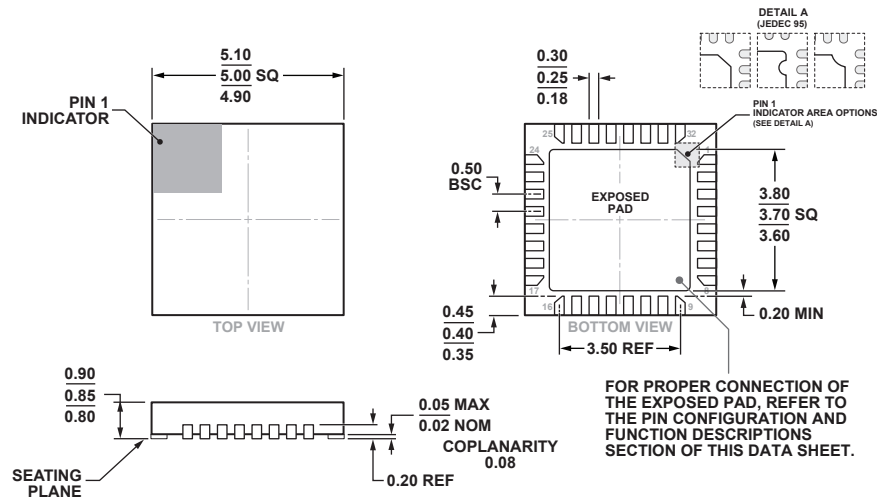

COMPLIANT TO JEDEC STANDARDS MO-220-VHHD-4.

32-Lead Lead Frame Chip Scale Package [LFCSP]  
5 mm x 5 mm and 0.85 mm Package Height  
(HCP-32-1)

Dimensions shown in millimeters.

### Package Information

Part Number	Package Body Material	Lead Finish	MSL Rating	Package Marking <sup>[3]</sup>
HMC465LP5	Low Stress Injection Molded Plastic	Sn/Pb Solder	MSL1 <sup>[1]</sup>	H465 XXXX
HMC465LP5E	RoHS-compliant Low Stress Injection Molded Plastic	100% matte Sn	MSL1 <sup>[2]</sup>	H465 XXXX

[1] Max peak reflow temperature of 235 °C

[2] Max peak reflow temperature of 260 °C

[3] 4-Digit lot number XXXX



**GAAS PHEMT MMIC MODULATOR DRIVER  
AMPLIFIER, DC - 20 GHz**

**Pin Descriptions**

Pin Number	Function	Description	Interface Schematic
1, 3, 4, 6 - 12, 14, 17, 18, 19, 20, 22 - 28, 31, 32	N/C	The pins are not connected internally; however, all data shown herein was measured with these pins connected to RF/DC ground externally.	
2	Vgg2	Gate Control 2 for amplifier. +1.5V should be applied to Vgg2 for nominal operation.	
5	RFIN	This pad is DC coupled and matched to 50 Ohms.	
13	Vgg1	Gate Control 1 for amplifier.	
15	ACG4	Low frequency termination. Attach bypass capacitor per application circuit herein.	
16	ACG3		
21	RFOUT & Vdd	RF output for amplifier. Connect the DC bias (Vdd) network to provide drain current (Idd). See application circuit herein.	
29	ACG2	Low frequency termination. Attach bypass capacitor per application circuit herein.	
30	ACG1		
Ground Paddle	GND	Ground paddle must be connected to RF/DC ground.	

**Application Circuit**

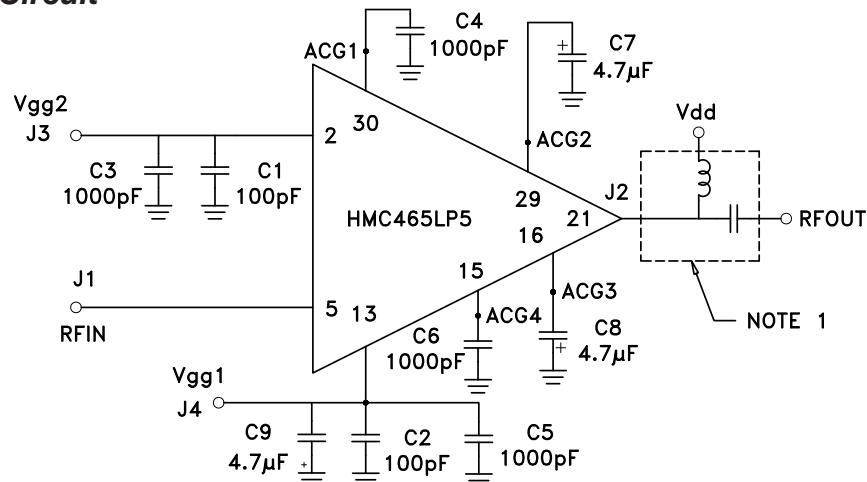

NOTE 1: Drain Bias (Vdd) must be applied through a broadband bias tee or external bias network.

**Evaluation PCB**

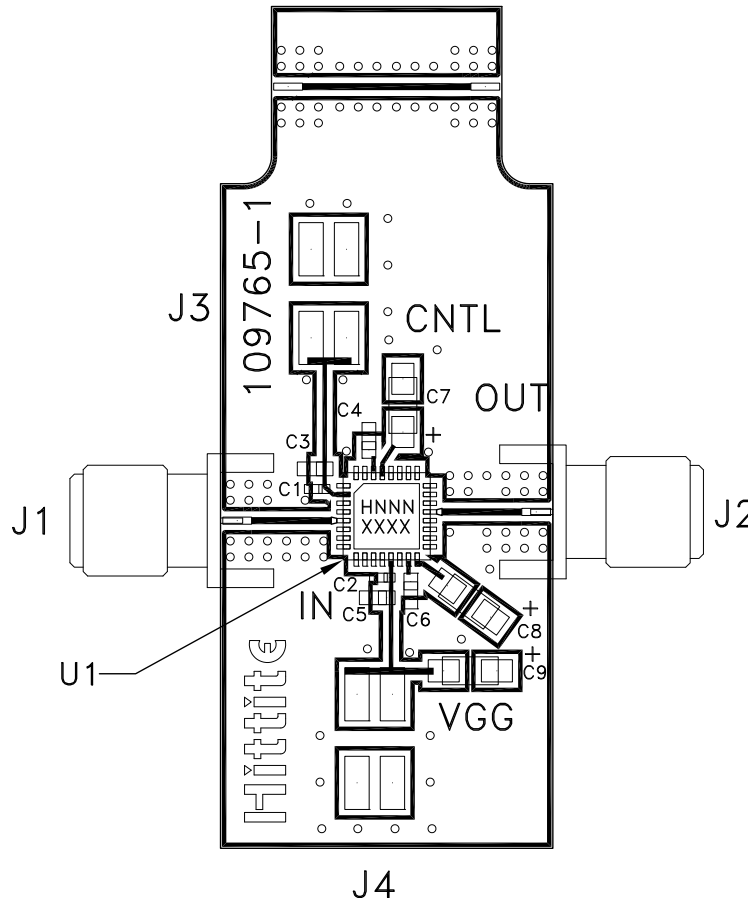

**List of Materials for Evaluation PCB 108347 [1]**

Item	Description
J1 - J2	SRI K Connector
J3 - J4	2mm Molex Header
C1, C2	100 pF Capacitor, 0402 Pkg.
C3 - C6	1000 pF Capacitor, 0603 Pkg.
C7 - C9	4.7 μF Capacitor, Tantalum
U1	HMC465LP5 / HMC465LP5E
PCB [2]	109765 Evaluation PCB

[1] Reference this number when ordering complete evaluation PCB

[2] Circuit Board Material: Rogers 4350

The circuit board used in the final application should use RF circuit design techniques. Signal lines should have 50 Ohm impedance while the package ground leads and package bottom should be connected directly to the ground plane similar to that shown. A sufficient number of via holes should be used to connect the top and bottom ground planes. The evaluation board should be mounted to an appropriate heat sink. The evaluation circuit board shown is available from Analog Devices, upon request.

**GAAS PHEMT MMIC MODULATOR DRIVER  
AMPLIFIER, DC - 20 GHz****Device Operation**

These devices are susceptible to damage from Electrostatic Discharge. Proper precautions should be observed during handling, assembly and test.

The input to this device should be AC-coupled. To provide the typical 8Vp-p output voltage swing, a 1.2Vp-p AC-coupled input voltage swing is required.

**Device Power Up Instructions**

1. Ground the device
  2. Set V<sub>gg</sub> to -2V (no drain current)
  3. Set V<sub>ctl</sub> to +1V (no drain current)
  4. Set V<sub>dd</sub> to +5V (no drain current)
  5. Adjust V<sub>gg</sub> for I<sub>dd</sub> = 140mA
- V<sub>gg</sub> may be varied between -1V and 0V to provide the desired eye crossing point percentage (i.e. 50% crosspoint) and a limited cross point control capability.
  - V<sub>dd</sub> may be increased to +8V if required to achieve greater output voltage swing.
  - V<sub>ctl</sub> may be adjusted between +2V and +0V to vary the output voltage swing.

**Device Power Down Instructions**

1. Reverse the sequence identified above in steps 1 through 4.



# HMC465LP5 / 465LP5E

v07.0418

## GAAS PHEMT MMIC MODULATOR DRIVER AMPLIFIER, DC - 20 GHz

**Notes:**





Компания «ЭлектроПласт» предлагает заключение долгосрочных отношений при поставках импортных электронных компонентов на взаимовыгодных условиях!

Наши преимущества:

- Оперативные поставки широкого спектра электронных компонентов отечественного и импортного производства напрямую от производителей и с крупнейших мировых складов;
- Поставка более 17-ти миллионов наименований электронных компонентов;
- Поставка сложных, дефицитных, либо снятых с производства позиций;
- Оперативные сроки поставки под заказ (от 5 рабочих дней);
- Экспресс доставка в любую точку России;
- Техническая поддержка проекта, помощь в подборе аналогов, поставка прототипов;
- Система менеджмента качества сертифицирована по Международному стандарту ISO 9001;
- Лицензия ФСБ на осуществление работ с использованием сведений, составляющих государственную тайну;
- Поставка специализированных компонентов (Xilinx, Altera, Analog Devices, Intersil, Interpoint, Microsemi, Aeroflex, Peregrine, Syfer, Eurofarad, Texas Instrument, Miteq, Cobham, E2V, MA-COM, Hittite, Mini-Circuits, General Dynamics и др.);

Помимо этого, одним из направлений компании «ЭлектроПласт» является направление «Источники питания». Мы предлагаем Вам помощь Конструкторского отдела:

- Подбор оптимального решения, техническое обоснование при выборе компонента;
- Подбор аналогов;
- Консультации по применению компонента;
- Поставка образцов и прототипов;
- Техническая поддержка проекта;
- Защита от снятия компонента с производства.



#### Как с нами связаться

**Телефон:** 8 (812) 309 58 32 (многоканальный)

**Факс:** 8 (812) 320-02-42

**Электронная почта:** [org@eplast1.ru](mailto:org@eplast1.ru)

**Адрес:** 198099, г. Санкт-Петербург, ул. Калинина, дом 2, корпус 4, литера А.