

Features

Switching Regulator

- Efficiency up to 97%, no need for heatsinks
- Pin-out compatible with LM78XX linears
- Very low profile
- 4.75V - 32V Wide input range
- Short circuit protection, thermal shutdown
- Low ripple and noise
- IEC/EN60950-1 certified
- Positive to negative converter

RECOM

DC/DC Converter

R-78-0.5

0.5 Amp
SIP3
Single Output



Description

The R-78xx-Series high efficiency switching regulators are ideally suited to replace 78xx linear regulators and are pin compatible. The efficiency of up to 97% means that very little energy is wasted as heat so there is no need for any heat sinks with their additional space and mounting costs. Low ripple and noise figures and short circuit, overload and over-temperature protection round off the specifications of this versatile converter series. This R-78xx-0.5 is fully certified to EN55032 EMC Standard and for IEC/EN-60950-1 + AM2 Safety.

Selection Guide

Part Number	Input Voltage Range [VDC]	Output Voltage [VDC]	Output Current [A]	Efficiency	
				@ min Vin [%]	@ max. Vin [%]
R-781.5-0.5	4.75 - 30 ⁽¹⁾	1.5	0.5	73	63
R-781.8-0.5	4.75 - 32	1.8	0.5	82	71
R-782.5-0.5	4.75 - 32	2.5	0.5	87	77
R-783.3-0.5	4.75 ⁽²⁾ - 32	3.3	0.5	91	81
R-785.0-0.5	6.5 - 32	5.0	0.5	94	86
R-786.5-0.5	8.0 - 32	6.5	0.5	95	88
R-789.0-0.5	11 - 32	9.0	0.5	96	92
R-7812-0.5	15 - 32	12	0.5	97	94
R-7815-0.5	18 - 32	15	0.5	97	95

Notes:

- Note1: 1.5V Output can be unstable with Vin>30VDC
 Note2: Refer to Transient Response on page I-3



IEC/EN60950-1 certified
 EN55032 compliant

Model Numbering

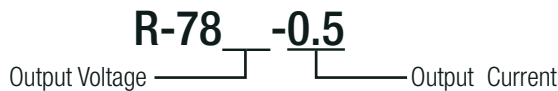

Specifications (measured @ Ta= 25°C, 10% minimum load, unless otherwise stated)

BASIC CHARACTERISTICS

Parameter	Condition	Min.	Typ.	Max.
Absolute Maximum Input Voltage				34VDC
Quiescent Current	nom. Vin= 24VDC		5mA	7mA
Internal Power Dissipation				0.4W
Minimum Load ⁽³⁾		0%		
Internal Operating Frequency		280kHz	330kHz	380kHz
Output Ripple and Noise	20MHz BW, without output capacitor	1.5 - 6.5VDC 9 - 15.5VDC	20mVp-p 30mVp-p	30mVp-p 40mVp-p
	20MHz BW ⁽⁴⁾	1.5VDC 1.8 - 15.5VDC	15mVp-p 25mVp-p	20mVp-p 35mVp-p
Absolute Maximum Capacitive Load	1 second start up, no external components			220µF
	<1 second start up + diode protection circuit			6800µF

Notes:

Note3: Operation under no load will not harm the converter, but specifications may not be met

A minimum load of 6mA is recommended

Note4: Measurements are made with a 100nF MLCC across output (low ESR)

Efficiency vs. Vin (full load)

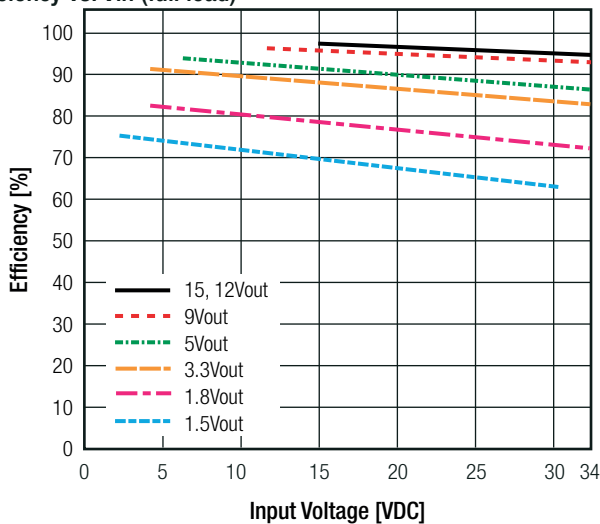

Ripple vs. Vin (full load)

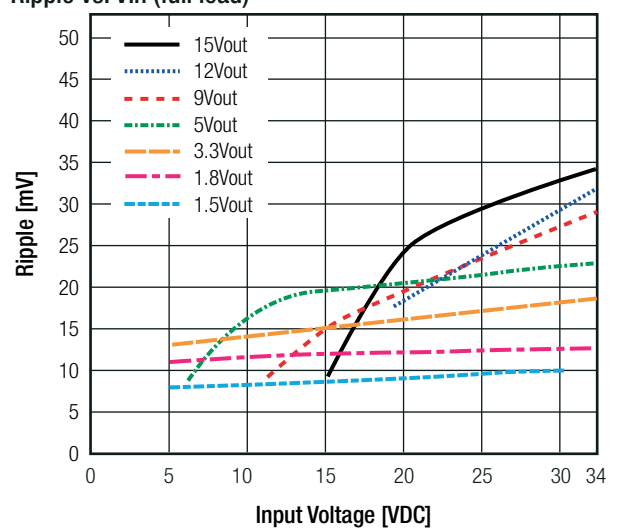

Efficiency vs. Load (max. Vin)

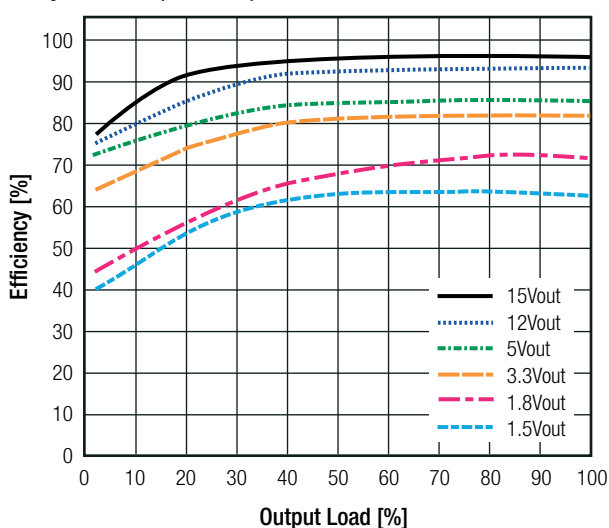

Ripple vs. Load (nom. Vin)

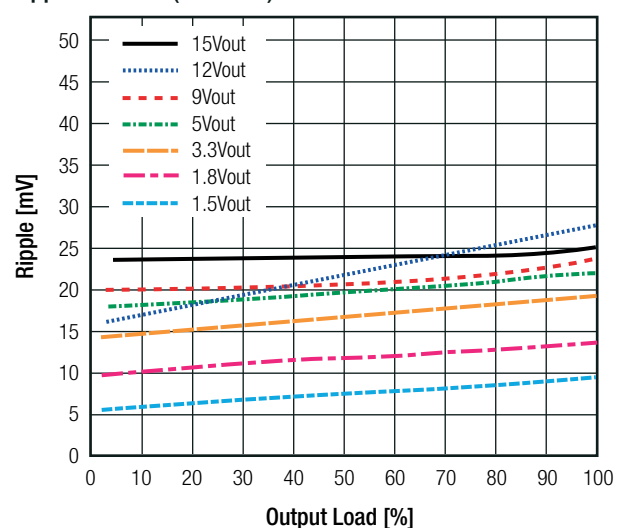

continued on next page

Specifications (measured @ Ta= 25°C, 10% minimum load, unless otherwise stated)

Efficiency vs. Load (min. Vin)

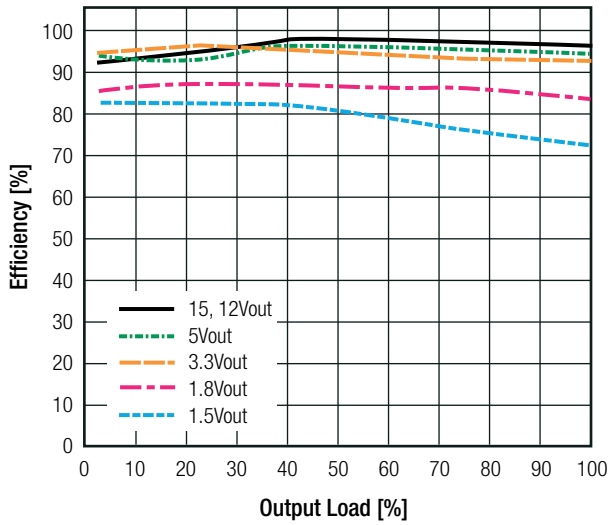

Ripple vs. Load (min. Vin)

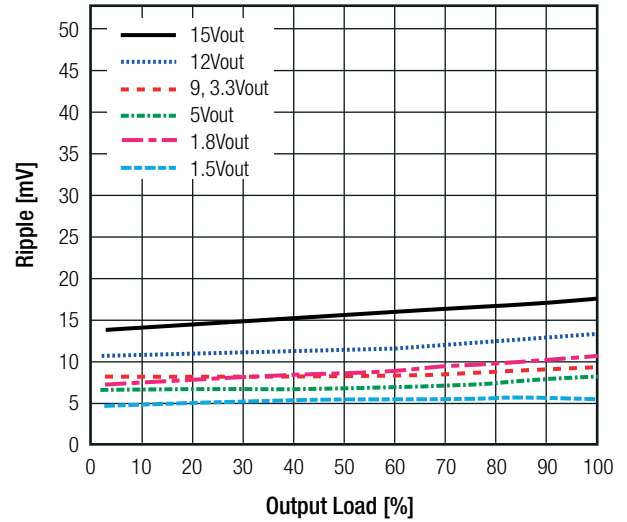

REGULATIONS

Parameter	Condition		Value
Output Accuracy	100% load		±2.0% typ / ±3.0% max.
Line Regulation	low line to high line, 100% load	1.5V - 6.5V 9V - 15.5V	±0.2% typ. / ±0.4% max. ±0.1% typ. / ±0.2% max.
Load Regulation	10% to 100% load	1.5V - 6.5V 9V - 15.5V	±0.4% typ. / ±0.6% max. ±0.25% typ. / ±0.4% max.
Transient Response ⁽⁵⁾	100% <-> 50% load 100% <-> 10% load		±75mV typ. ±100mV max.

Notes:

Note5: The R.783.3-0.5 requires Vin>5.5V to meet the Transient Response specifications

PROTECTIONS

Parameter	Condition	Value
Short Circuit Protection (SCP)		continuous, automatic recovery
Short Circuit Input Current	nom. Vin= 24VDC	60mA max.

Optional Diode Protection Circuit

Add a blocking diode to Vout if current can flow backwards into the output, as this can damage the converter when it is powered down.

The diode can either be fitted across the device if the source is low impedance or fitted in series with the output (recommended).

Application example:

Driving a high capacitive load

Optional Protection 1:

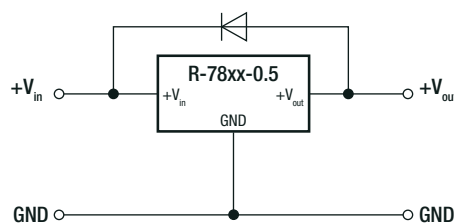

Optional Protection 2:

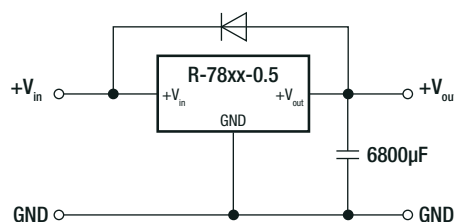
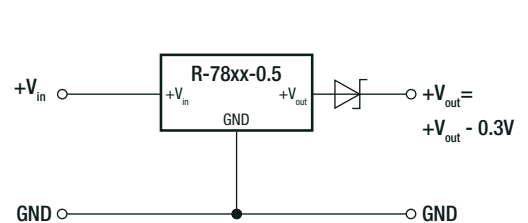

Specifications (measured @ Ta= 25°C, 10% minimum load, unless otherwise stated)

ENVIRONMENTAL

Parameter	Condition		Value
Operating Temperature Range	with derating (see graph)		-40°C to +85°C
Maximum Case Temperature			+100°C
Temperature Coefficient			±0.015%/K
Thermal Impedance	0.1 m/s, vertical		70K/W
Operating Altitude			2000m
Operating Humidity	non-condensing		95% RH max.
Pollution Degree			PD2
MTBF	according to MIL-HDBK-217F, G.B.	+25°C	26163 x 10 ³ hours

Derating Graph

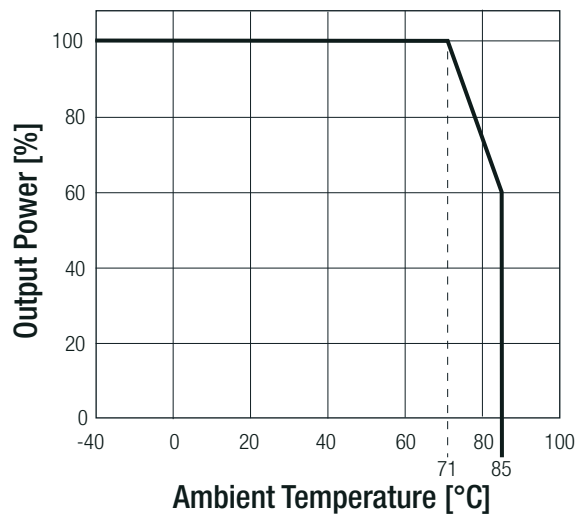

SAFETY AND CERTIFICATIONS

Certificate Type (Safety)	Report / File Number	Standard
Information Technology Equipment, General Requirements for Safety	1603123	IEC60950-1:2005, 2nd Edition + Am 2:2013 EN60950-1:2006 + Am 2:2013
EAC	RU-AT.49.09571	TP TC 004/2011
RoHS 2+		RoHS 2011/65/EU + AM2015/863

EMC Compliance	Condition	Standard / Criterion
Electromagnetic compatibility of multimedia equipment - Emission requirements	with external filter (see filter suggestion below)	EN55032, Class A and B
ESD Electrostatic discharge immunity test	Contact ±6kV	EN61000-4-2, Criteria A
Radiated, radio-frequency, electromagnetic field immunity test	3V/m	EN61000-4-3, Criteria A
Fast Transient and Burst Immunity	±1.0kV	EN61000-4-4, Criteria A
Immunity to conducted disturbances, induced by radio-frequency fields	3V	EN61000-4-6, Criteria A
Power Magnetic Field Immunity	50Hz, 3A/m	EN61000-4-8, Criteria A

continued on next page

Specifications (measured @ Ta= 25°C, 10% minimum load, unless otherwise stated)

EMC Filter Suggestion according to EN55032

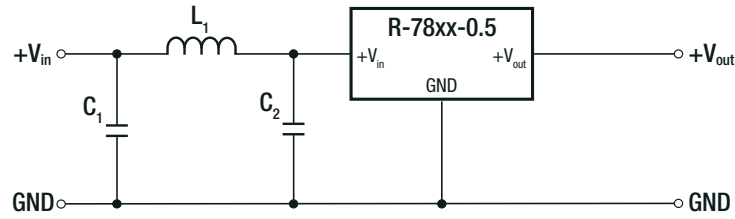

Component List Class A

MODEL	C1	C2	L1
R-785.0-0.5	10µF	3.3µF	3.9µH choke
R-7812-0.5	100V MLCC	100V MLCC	RLS-397

Component List Class B

MODEL	C1	C2	L1
R-785.0-0.5	10µF	3.3µF	5.6µH choke
R-7812-0.5	100V MLCC	100V MLCC	RLS-567

Notes:

Note6: Filter suggestions are valid for indicated part numbers only. For other part numbers, please contact RECOM tech support for advice

DIMENSION AND PHYSICAL CHARACTERISTICS

Parameter	Type	Value
Material	case potting PCB	non-conductive black plastic, (UL94 V-0) silicone, (UL94 V-0) FR4, (UL94 V-0)
Package Dimension (LxWxH)		11.5 x 7.55 x 10.2mm
Package Weight		1.9g typ.

Dimension Drawing (mm)

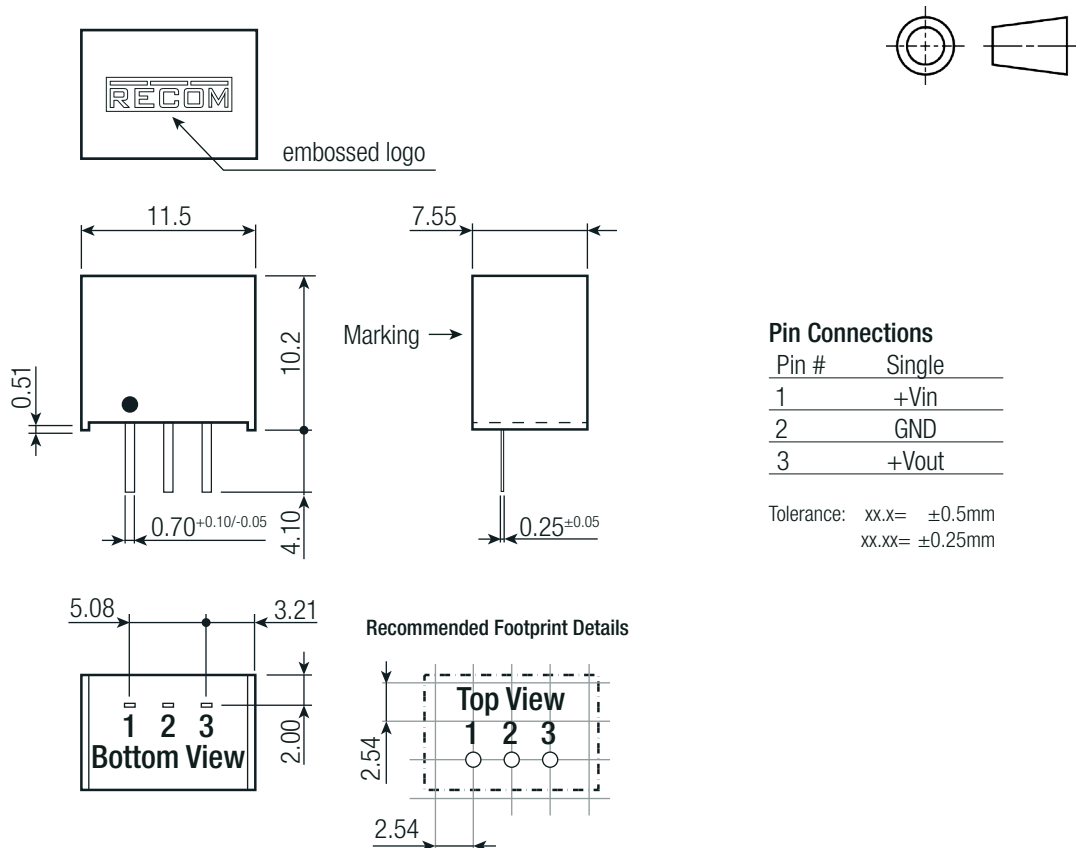

Pin Connections

Pin #	Single
1	+Vin
2	GND
3	+Vout

Tolerance: xx.x= ±0.5mm
xx.xx= ±0.25mm

Specifications (measured @ Ta= 25°C, 10% minimum load, unless otherwise stated)

INSTALLATION AND APPLICATION

Positive to Negative Converter

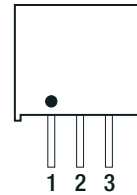
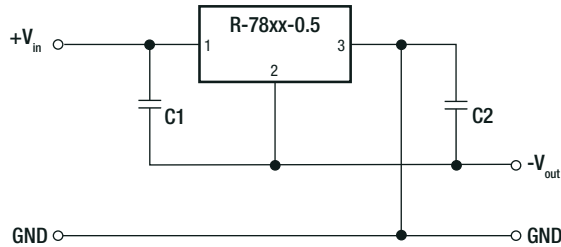

C1 and C2 are required and should be fitted close to the converter pins.

Maximum capacitive load including C2 is 220µF

Pin Connections

Pin #	Negative	Positive
1	+Vin	+Vin
2	-Vout	GND
3	GND	+Vout

Selection Guide - Negative Output

Part Number	Input Voltage Range [VDC]	Output Voltage [VDC]	Output Current [A]	Efficiency		External Capacitor	
				@ min Vin [%]	@ max. Vin [%]	C1	C2 ⁽⁷⁾
R-781.5-0.5	4.75 - 28	-1.5	-0.4	68	67	10µF/35V	22µF/6.3V
R-781.8-0.5	4.75 - 28	-1.8	-0.4	71	70	10µF/50V	22µF/6.3V
R-782.5-0.5	4.75 - 28	-2.5	-0.4	75	76	10µF/50V	22µF/6.3V
R-783.3-0.5	4.75 - 28	-3.3	-0.4	77	80	10µF/50V	22µF/6.3V
R-785.0-0.5	4.75 - 28	-5.0	-0.4	79	84	10µF/50V	22µF/10V
R-786.5-0.5	5.0 - 26	-6.5	-0.3	81	86	10µF/50V	10µF/10V
R-789.0-0.5	8.0 - 18	-9.0	-0.2	87	89	10µF/50V	10µF/16V
R-7812-0.5	8.0 - 18	-12	-0.2	87	90	10µF/50V	10µF/25V
R-7815-0.5	8.0 - 18	-15	-0.2	87	81	10µF/50V	10µF/25V

Notes:

Note7: Maximum Capacitive Load including C2 is 220µF

Dual Output (two Converters) with Negative Output

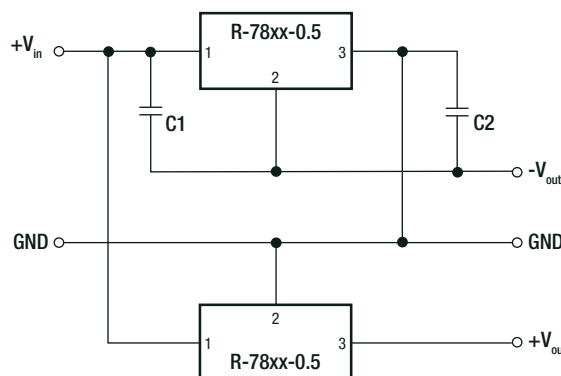

continued on next page

Specifications (measured @ Ta= 25°C, 10% minimum load, unless otherwise stated)

Standard Application Circuit

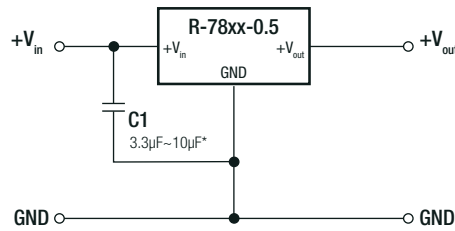

* Input capacitor required if $V_{in} > 26VDC$ (3.3µF) or if the supply is a battery or other low impedance source (4.7µF~10µF)
Capacitor should be electrolytic or MLCC with low ESR ($\leq 1\Omega$)

High Efficiency, Isolated, Dual Unregulated Output

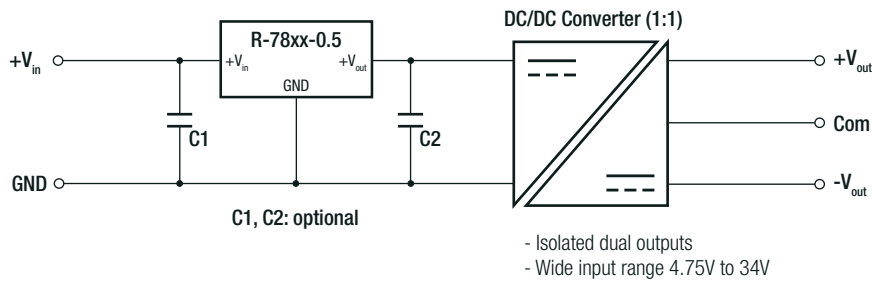

Isolated (up to 6kVDC), Wide Input Range Regulated Output

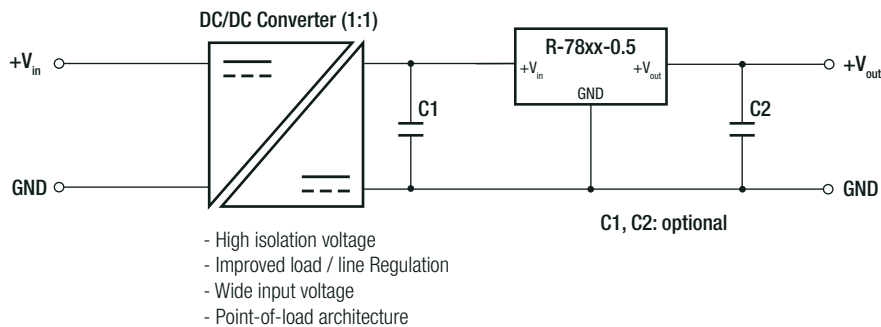

PACKAGING INFORMATION

Parameter	Type	Value
Packaging Dimension (LxWxH)	tube	520.0 x 9.3 x 16.5mm
Packaging Quantity	tube	42pcs
Storage Temperature Range		-55°C to +125°C
Storage Humidity		95% RH max.

The product information and specifications may be subject to changes even without prior written notice. The product has been designed for various applications; its suitability lies in the responsibility of each customer. The products are not authorized for use in safety-critical applications without RECOM's explicit written consent. A safety-critical application is an application where a failure may reasonably be expected to endanger or cause loss of life, inflict bodily harm or damage property. The applicant shall indemnify and hold harmless RECOM, its affiliated companies and its representatives against any damage claims in connection with the unauthorized use of RECOM products in such safety-critical applications.



Компания «ЭлектроПласт» предлагает заключение долгосрочных отношений при поставках импортных электронных компонентов на взаимовыгодных условиях!

Наши преимущества:

- Оперативные поставки широкого спектра электронных компонентов отечественного и импортного производства напрямую от производителей и с крупнейших мировых складов;
- Поставка более 17-ти миллионов наименований электронных компонентов;
- Поставка сложных, дефицитных, либо снятых с производства позиций;
- Оперативные сроки поставки под заказ (от 5 рабочих дней);
- Экспресс доставка в любую точку России;
- Техническая поддержка проекта, помощь в подборе аналогов, поставка прототипов;
- Система менеджмента качества сертифицирована по Международному стандарту ISO 9001;
- Лицензия ФСБ на осуществление работ с использованием сведений, составляющих государственную тайну;
- Поставка специализированных компонентов (Xilinx, Altera, Analog Devices, Intersil, Interpoint, Microsemi, Aeroflex, Peregrine, Syfer, Eurofarad, Texas Instrument, Miteq, Cobham, E2V, MA-COM, Hittite, Mini-Circuits, General Dynamics и др.);

Помимо этого, одним из направлений компании «ЭлектроПласт» является направление «Источники питания». Мы предлагаем Вам помощь Конструкторского отдела:

- Подбор оптимального решения, техническое обоснование при выборе компонента;
- Подбор аналогов;
- Консультации по применению компонента;
- Поставка образцов и прототипов;
- Техническая поддержка проекта;
- Защита от снятия компонента с производства.



Как с нами связаться

Телефон: 8 (812) 309 58 32 (многоканальный)

Факс: 8 (812) 320-02-42

Электронная почта: org@eplast1.ru

Адрес: 198099, г. Санкт-Петербург, ул. Калинина, дом 2, корпус 4, литера А.