

# High Temperature, Programmable SMD MEMS Oscillator



2.0 x 1.6 x 0.75mm; 2.5 x 2.0 x 0.75mm;  
3.2 x 2.5 x 0.75mm; 5.0 x 3.2 x 0.75mm;  
7.0 x 5.0 x 0.9mm

ASTMHT



RoHS/RoHS II compliant

Moisture Sensitivity Level (MSL) – 1

## FEATURES:

- Industry standard package sizes: 2.0 x 1.6 x 0.75mm, 2.5 x 2.0 x 0.75mm, 3.2 x 2.5 x 0.75mm, 5 x 3.2 x 0.75mm, 7.0 x 5.0 x 0.9mm
- Output frequency between 1MHz and 137MHz
- Supply voltage options: 3.3V, 3.0V, 2.8V, 2.5V, 1.8V, 2.25V ~ 3.63V
- Low current consumption: 3.5mA typ. (@20MHz, 1.8V, no load); 4.9mA typ. (@125MHz, 1.8V, no load)
- Wide operating temperature range options: -40 ~ +105°C; -40 ~ +125°C; -55 ~ +125°C
- Frequency stability options: ±20ppm, ±25ppm, ±30ppm, ±50ppm
- Factory programmable drive strength for improved jitter, reduced EMI or higher capacitive output load

## APPLICATIONS:

- High temperature applications for Industrial, medical, non-automotive and avionics
- Harsh environment (vibration, shock-prone and humid)

## STANDARD SPECIFICATIONS:

All electrical specifications are specified with 15pF output load and for all V<sub>dd</sub>(s) unless otherwise stated. The typical value of any parameter in the table is specified for the nominal value of the highest voltage option for that parameter and at 25°C temperature.

Parameters	Min	Typ	Max	Unit	Notes
Output Frequency Range (F)	1.000000		110.000000	MHz	Available with operation temp. range option "X", "A" and "Z"
	115.194001		119.342000		Available with operation temp. range option "X" and "A"
	119.342001		137.000000		Available with operation temp. range option "X", "A" and "Z"
Standard Frequencies	See Section 1.1 for Standard Frequencies			MHz	
Frequency Stability (F <sub>stab</sub> )	-20		+20	ppm	Inclusive of initial tolerance at 25°C, 1 <sup>st</sup> year aging at 25°C, and variations over operating temperature, rated power supply voltage and load (15pF±10%)
	-25		+25		
	-30		+30		
	-50		+50		
Operating Temperature Range (T <sub>use</sub> )	-40		+105	°C	Option "X"
	-40		+125		Option "A"
	-55		+125		Option "Z"
Supply Voltage (V <sub>dd</sub> )	1.62	1.8	1.98	V	Option "18"
	2.25	2.5	2.75		Option "25"
	2.52	2.8	3.08		Option "28"
	2.7	3.0	3.3		Option "30"
	2.97	3.3	3.63		Option "33"
	2.25		3.63		Option "Blank" (default)
Current Consumption (I <sub>dd</sub> )		3.8	4.7	mA	No load, F=20MHz, V <sub>dd</sub> =2.8V,3.0V,3.3V
		3.6	4.5		No load, F=20MHz, V <sub>dd</sub> =2.5V
		3.5	4.5		No load, F=20MHz, V <sub>dd</sub> =1.8V
		6.2	8		No load, F=125MHz, V <sub>dd</sub> =2.8V,3.0V,3.3V
		5.4	7		No load, F=125MHz, V <sub>dd</sub> =2.5V
		4.9	6		No load, F=125MHz, V <sub>dd</sub> =1.8V
OE Disable Current (I <sub>OD</sub> )			4.5	mA	F=1MHz~110MHz, V <sub>dd</sub> =2.5V-3.3V, OE=Low, output is in High-Z state
			4.3		F=1MHz~110MHz, V <sub>dd</sub> =1.8V, OE=Low, output is in High-Z state
			4.7		F=115.194001MHz~110MHz, V <sub>dd</sub> =2.5V-3.3V, OE=Low, output is in High-Z state
			4.5		F=115.194001MHz~110MHz, V <sub>dd</sub> =1.8V, OE=Low, output is in High-Z state

ABRACON IS  
ISO9001:2008  
CERTIFIED



5101 Hidden Creek Lane Spicewood TX 78669  
Phone: 512-371-6159 | Fax: 512-351-8858  
For terms and conditions of sales please visit:  
www.abracon.com

Revised: 06.17.2016

# High Temperature, Programmable SMD MEMS Oscillator



ASTMHT



RoHS/RoHS II compliant

2.0 x 1.6 x 0.75mm; 2.5 x 2.0 x 0.75mm;  
3.2 x 2.5 x 0.75mm; 5.0 x 3.2 x 0.75mm;  
7.0 x 5.0 x 0.9mm

(Continued)

Parameters	Min	Typ	Max	Unit	Notes
Standby Current ( $I_{std}$ )		2.6	8.5	$\mu A$	$\overline{ST}$ =Low, $V_{dd}$ =2.8V-3.3V, output is weakly pulled down
		1.4	5.5		$\overline{ST}$ =Low, $V_{dd}$ =2.5V, output is weakly pulled down
		0.6	4.0		$\overline{ST}$ =Low, $V_{dd}$ =1.8V, output is weakly pulled down
Output Type	LVCMOS				
Duty Cycle	45		55	%	All $V_{dd}$ options
Rise/Fall Time ( $T_r/T_f$ )		1	2	ns	$V_{dd}$ =2.5V, 2.8V, 3.0V or 3.3V, 20%-80%
		1.3	2.5		$V_{dd}$ =1.8V, 20%-80%
		1	3		$V_{dd}$ =2.25V-3.63V, 20%-80%
Output High Voltage ( $V_{OH}$ )	90%* $V_{dd}$			V	$I_{OH}$ =-4mA ( $V_{dd}$ =3.0V or 3.3V)
					$I_{OH}$ =-3mA ( $V_{dd}$ =2.8V or 2.5V)
					$I_{OH}$ =-2mA ( $V_{dd}$ =1.8V)
Output Low Voltage ( $V_{OL}$ )			10%* $V_{dd}$	V	$I_{OL}$ =4mA ( $V_{dd}$ =3.0V or 3.3V)
					$I_{OL}$ =3mA ( $V_{dd}$ =2.8V or 2.5V)
					$I_{OL}$ =2mA ( $V_{dd}$ =1.8V)
Input High Voltage( $V_{IH}$ )	70%* $V_{dd}$			V	Pin 1
Input Low Voltage( $V_{IL}$ )			30%* $V_{dd}$	V	Pin 1
Input Pull-up Impedance ( $Z_{in}$ )	50	87	150	k $\Omega$	Pin 1, OE logic high or logic low, $\overline{ST}$ logic high
	2			M $\Omega$	Pin 1, $\overline{ST}$ logic low
Startup Time ( $T_{start}$ )			5	ms	Measured from the time $V_{dd}$ reaches 90% of its final value
Enable/Disable Time ( $T_{oe}$ )			130	ns	F=110MHz, 115.194001MHz, 119.342001MHz. For other frequencies, $T_{oe}$ =100ns+3*cycles
Resume Time ( $T_{resume}$ )			5	ms	Measured from the time $\overline{ST}$ pin crosses 50% threshold
RMS Period Jitter ( $T_{jitt}$ )		1.6	2.5	ps	F=75MHz, 125MHz, $V_{dd}$ =2.5V, 2.8V, 3.0V or 3.3V
		1.9	3		F=75MHz, 125MHz, $V_{dd}$ =1.8V
Peak-to-peak Period Jitter ( $T_{pk}$ )		12	20	ps	F=75MHz, 125MHz, $V_{dd}$ =2.5V, 2.8V, 3.0V or 3.3V
		14	25		F=75MHz, 125MHz, $V_{dd}$ =1.8V
RMS Phase Jitter (random) ( $T_{phj}$ )		0.5	0.8	ps	F=75MHz, 125MHz integration bandwidth=900kHz to 7.5MHz
		1.3	2		F=75MHz, 125MHz integration bandwidth=12kHz to 20MHz

# High Temperature, Programmable SMD MEMS Oscillator



2.0 x 1.6 x 0.75mm; 2.5 x 2.0 x 0.75mm;  
3.2 x 2.5 x 0.75mm; 5.0 x 3.2 x 0.75mm;  
7.0 x 5.0 x 0.9mm

ASTMHT



RoHS/RoHS II compliant

## Standard Frequency (MHz)

Standard Frequency (MHz)								
7.3728	8	8.192	9.8304	9.84375	11.0592	12	12.288	13
13.225625	13.52127	14.31818	14.7456	15	16	16.384	18.432	19.6608
20	22.1184	24	24.56	24.576	25	26	27	29.4912
30	32	33	36	40	48			

## Absolute Maximum Ratings

Attempted operation outside the absolute maximum ratings may cause permanent damage to the part. Actual performance of the IC is only guaranteed within the operational specifications, not at absolute maximum ratings.

Parameters	Min.	Max.	Unit
Storage Temperature	-65	150	°C
V <sub>DD</sub>	-0.5	4	V
Electrostatic Discharge (HBM)		2000	V
Soldering Temperature (follow standard Pb free soldering guidelines)		260	°C
Junction Temperature <sup>(1)</sup>		150	°C

Note: 1. Exceeding this temperature for extended period of time may damage the device

## Thermal Consideration

Package	θJA, 4 Layer Board (°C/W)	θJA, 2 Layer Board (°C/W)	θJC, Bottom (°C/W)
7.0 x 5.0mm	142	273	30
5.0 x 3.2mm	97	199	24
3.2 x 2.5mm	109	212	27
2.5 x 2.0mm	117	222	26
2.0 x 1.6mm	152	252	36

## Maximum Operating Junction Temperature <sup>(2)</sup>

Max. Operating Temperature (ambient)	Max. Operating Junction Temperature
105°C	115°C
125°C	135°C

Note: 2. Datasheet specifications are not guaranteed if junction temperature exceeds the maximum operating junction temperature

# High Temperature, Programmable SMD MEMS Oscillator



2.0 x 1.6 x 0.75mm; 2.5 x 2.0 x 0.75mm;  
3.2 x 2.5 x 0.75mm; 5.0 x 3.2 x 0.75mm;  
7.0 x 5.0 x 0.9mm

ASTMHT



RoHS/RoHS II compliant

## PART IDENTIFICATION:

ASTMHT [ ] - [ ] - [ ] MHz - [ ] [ ] - [ ] [ ] - [ ]

Package Size
A: 2.0x1.6mm
D: 2.5x2.0mm
E: 3.2x2.5mm
FL: 5.0x3.2mm
V: 7.0x5.0mm

Output Frequency in MHz
e.g. 7.3728, 125.000

Operating Temp.
X: -40°C ~ +105°C
A: -40°C ~ +125°C
Z: -55°C ~ +125°C

Pin 1 Function
E: Output Enable
S: Standby
N: No Connect

Packaging
Blank: Bulk
T: Tape & Reel (1kpcs / reel)
T3: Tape & Reel (3kpcs / reel)

Supply Voltage
Blank: 2.25V~3.63V
18: 1.8V±10%
25: 2.5V±10%
28: 2.8V±10%
30: 3.0V±10%
33: 3.3V±10%

Freq. Stability
J: ±20ppm
R: ±25 ppm
K: ±30ppm
C: ±50 ppm

Output Drive Strength*
Blank: Default
L**
A**
R
B
T
E
U
F

\* See Table 1 to 5 for the Rise/Fall times at different drive strength and available options

\*\* Only available for F=1MHz~110MHz

List of Supported Frequency Ranges (MHz)			
-40°C~+105°C/-40°C~+125°C		-55°C~+125°C	
Min	Max	Min	Max
1.000000	61.222999	1.000000	61.222999
61.974001	69.795999	61.674001	69.239999
70.485001	79.062999	70.827001	78.714999
79.162001	81.427999	79.561001	80.159999
82.232001	91.833999	80.174001	80.779999
92.155001	94.248999	82.632001	91.833999
94.430001	94.874999	95.474001	96.191999
94.994001	97.713999	96.209001	96.935999
98.679001	110.000000	99.158001	110.000000
115.194001	117.810999	119.342001	120.238999
118.038001	118.593999	120.262001	121.169999
118.743001	122.141999	121.243001	121.600999
122.705001	123.021999	123.948001	137.000000
123.348001	137.000000		



**Table 1:  $V_{dd}=1.8V$  Rise/Fall Times for Specific  $C_{LOAD}$**

**(a) Output Frequency: 1MHz – 110MHz**

Drive Strength Options	Rise/Fall Time Typ. (ns)				
	$C_{LOAD}$				
	5pF	15pF	30pF	45pF	60pF
L	6.16	11.61	22.00	31.27	39.91
A	3.19	6.35	11.00	16.01	21.52
R	2.11	4.31	7.65	10.77	14.47
B	1.65	3.23	5.79	8.18	11.08
T	0.93	1.91	3.32	4.66	6.48
E	0.78	1.66	2.94	4.09	5.74
U	0.70	1.48	2.64	3.68	5.09
F or Blank (default)	0.65	1.30	2.40	3.35	4.56

**(b) Output Frequency: 115.194001MHz – 137MHz**

Drive Strength Options	Rise/Fall Time Typ. (ns)	
	$C_{LOAD}$	
	5pF	15pF
T	0.93	N/A
E	0.78	N/A
U	0.70	1.48
F or Blank (default)	0.65	1.30

**Table 2:  $V_{dd}=2.5V$  Rise/Fall Times for Specific  $C_{LOAD}$**

**(a) Output Frequency: 1MHz – 110MHz**

Drive Strength Options	Rise/Fall Time Typ. (ns)				
	$C_{LOAD}$				
	5pF	15pF	30pF	45pF	60pF
L	4.13	8.25	12.82	21.45	27.79
A	2.11	4.27	7.64	11.20	14.49
R	1.45	2.81	5.16	7.65	9.88
B	1.09	2.20	3.88	5.86	7.57
T	0.62	1.28	2.27	3.51	4.45
E or Blank (default)	0.54	1.00	2.01	3.10	4.01
U	0.43	0.96	1.81	2.79	3.65
F	0.34	0.88	1.64	2.54	3.32

**(b) Output Frequency: 115.194001MHz – 137MHz**

Drive Strength Options	Rise/Fall Time Typ. (ns)	
	$C_{LOAD}$	
	5pF	15pF
R	1.45	N/A
B	1.09	N/A
T	0.62	1.28
E or Blank (default)	0.54	1.00
U	0.43	0.96
F	0.34	0.88

**Table 3:  $V_{dd}=2.8V$  Rise/Fall Times for Specific  $C_{LOAD}$**

**(a) Output Frequency: 1MHz – 110MHz**

Drive Strength Options	Rise/Fall Time Typ. (ns)				
	$C_{LOAD}$				
	5pF	15pF	30pF	45pF	60pF
L	3.77	7.54	12.28	19.57	25.27
A	1.94	3.90	7.03	10.24	13.34
R	1.29	2.57	4.72	7.01	9.06
B	0.97	2.00	3.54	5.43	6.93
T	0.55	1.12	2.08	3.22	4.08
E or Blank (default)	0.44	1.00	1.83	2.82	3.67
U	0.34	0.88	1.64	2.52	3.30
F	0.29	0.81	1.48	2.29	2.99

**(b) Output Frequency: 115.194001MHz – 137MHz**

Drive Strength Options	Rise/Fall Time Typ. (ns)		
	$C_{LOAD}$		
	5pF	15pF	30pF
R	1.29	N/A	N/A
B	0.97	N/A	N/A
T	0.55	1.12	N/A
E or Blank (default)	0.44	1.00	N/A
U	0.34	0.88	N/A
F	0.29	0.81	1.48



## TYPICAL PERFORMANCE DATA

**Table 4: V<sub>dd</sub>=3.0V Rise/Fall Times for Specific C<sub>LOAD</sub>**

(a) Output Frequency: 1MHz – 110MHz

Drive Strength Options	Rise/Fall Time Typ. (ns)				
	C <sub>LOAD</sub>				
	5pF	15pF	30pF	45pF	60pF
L	3.60	7.21	11.97	18.74	24.30
A	1.84	3.71	6.72	9.86	12.68
R	1.22	2.46	4.54	6.76	8.62
B	0.89	1.92	3.39	5.20	6.64
T or Blank (default)	0.51	1.00	1.97	3.07	3.90
E	0.38	0.92	1.72	2.71	3.51
U	0.30	0.83	1.55	2.40	3.13
F	0.27	0.76	1.39	2.16	2.85

(b) Output Frequency: 115.194001MHz – 137MHz

Drive Strength Options	Rise/Fall Time Typ. (ns)		
	C <sub>LOAD</sub>		
	5pF	15pF	30pF
R	1.22	N/A	N/A
B	0.89	N/A	N/A
T or Blank (default)	0.51	1.00	N/A
E	0.38	0.92	N/A
U	0.30	0.83	N/A
F	0.27	0.76	1.39

**Table 5: V<sub>dd</sub>=3.3V Rise/Fall Times for Specific C<sub>LOAD</sub>**

(a) Output Frequency: 1MHz – 110MHz

Drive Strength Options	Rise/Fall Time Typ. (ns)				
	C <sub>LOAD</sub>				
	5pF	15pF	30pF	45pF	60pF
L	3.39	6.88	11.63	17.56	23.59
A	1.74	3.50	6.38	8.98	12.19
R	1.16	2.33	4.29	6.04	8.34
B	0.81	1.82	3.22	4.52	6.33
T or Blank (default)	0.46	1.00	1.86	2.60	3.84
E	0.33	0.87	1.64	2.30	3.35
U	0.28	0.79	1.46	2.05	2.93
F	0.25	0.72	1.31	1.83	2.61

(b) Output Frequency: 115.194001MHz – 137MHz

Drive Strength Options	Rise/Fall Time Typ. (ns)		
	C <sub>LOAD</sub>		
	5pF	15pF	30pF
R	1.16	N/A	N/A
B	0.81	N/A	N/A
T or Blank (default)	0.46	1.00	N/A
E	0.33	0.87	N/A
U	0.28	0.79	1.46
F	0.25	0.72	1.31

### Calculating Maximum Frequency

Based on the rise and fall time data given in Table 1 through 5, the maximum frequency the oscillator can operate with a guaranteed full swing of the output voltage over temperature is calculated as follows:

$$Max. Frequency = \frac{1}{5 \times T_{r/f}}$$

Example:

Calculate F<sub>max</sub> of a 1MHz ~ 110MHz device with the following condition:

- V<sub>dd</sub> = 1.8V (Table 1)
- Capacitive Load = 30pF
- Desired T<sub>r/f</sub> Time: = 3ns (rise/fall time option code “E”)

The F<sub>max</sub> is 66.66666MHz.

# High Temperature, Programmable SMD MEMS Oscillator



ASTMHT



RoHS/RoHS II compliant

2.0 x 1.6 x 0.75mm; 2.5 x 2.0 x 0.75mm;  
3.2 x 2.5 x 0.75mm; 5.0 x 3.2 x 0.75mm;  
7.0 x 5.0 x 0.9mm

## TYPICAL PERFORMANCE DATA

All plots are measured with 15pF load at room temperature, unless otherwise stated.

### I<sub>DD</sub> vs. Frequency

1MHz-110MHz Devices



115.194001MHz -137MHz Devices



### Frequency vs. Temperature



# High Temperature, Programmable SMD MEMS Oscillator



ASTMHT



RoHS/RoHS II compliant

2.0 x 1.6 x 0.75mm; 2.5 x 2.0 x 0.75mm;  
3.2 x 2.5 x 0.75mm; 5.0 x 3.2 x 0.75mm;  
7.0 x 5.0 x 0.9mm

## TYPICAL PERFORMANCE DATA

### RMS Period Jitter vs. Frequency

1MHz-110MHz Devices

115.194001MHz -137MHz Devices

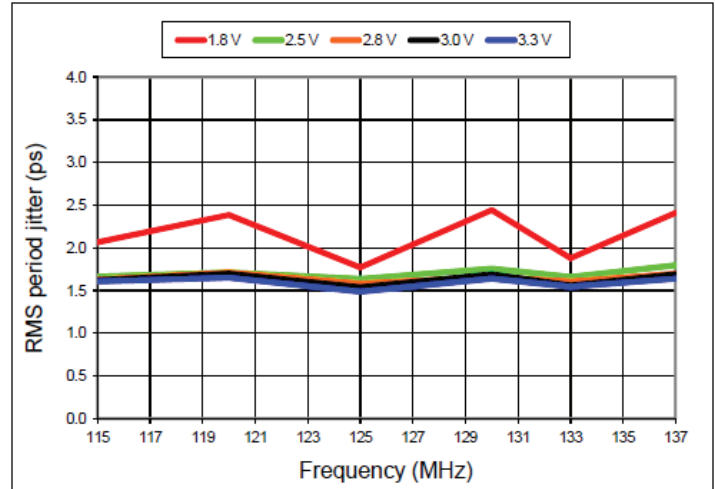
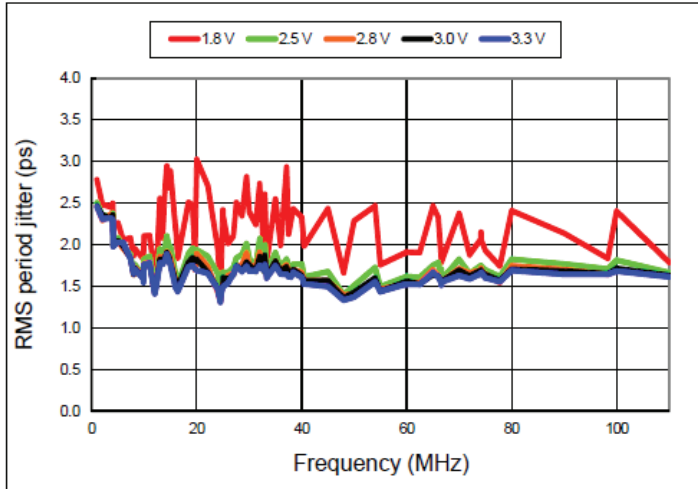

### Duty Cycle vs. Frequency

1MHz-110MHz Devices

115.194001MHz -137MHz Devices

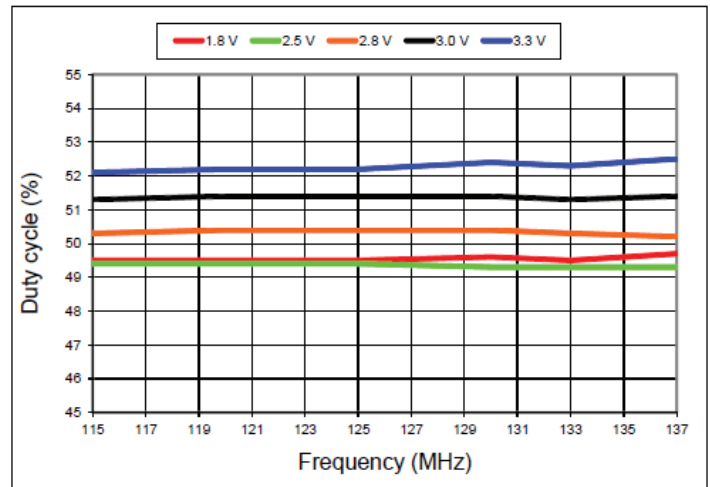
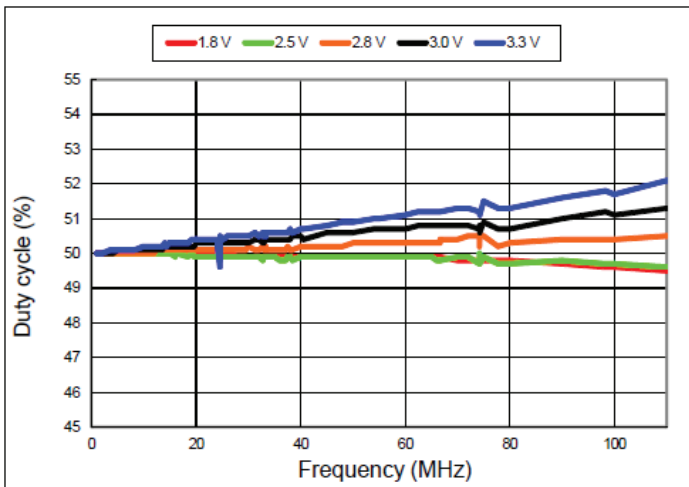



# High Temperature, Programmable SMD MEMS Oscillator



ASTMHT



RoHS/RoHS II compliant

2.0 x 1.6 x 0.75mm; 2.5 x 2.0 x 0.75mm;  
3.2 x 2.5 x 0.75mm; 5.0 x 3.2 x 0.75mm;  
7.0 x 5.0 x 0.9mm

## TYPICAL PERFORMANCE DATA

### 20% - 80% Rise Time vs. Temperature

1MHz-110MHz Devices



115.194001MHz -137MHz Devices



### 20% - 80% Fall Time vs. Temperature



# High Temperature, Programmable SMD MEMS Oscillator



ASTMHT



RoHS/RoHS II compliant

2.0 x 1.6 x 0.75mm; 2.5 x 2.0 x 0.75mm;  
3.2 x 2.5 x 0.75mm; 5.0 x 3.2 x 0.75mm;  
7.0 x 5.0 x 0.9mm

## TYPICAL PERFORMANCE DATA

### RMS Integrated Phase Jitter Random (12kHz to 20MHz) vs Frequency <sup>(3)</sup>

1MHz-110MHz Devices



115.194001MHz -137MHz Devices



### RMS Integrated Phase Jitter Random (900kHz to 7.5MHz) vs Frequency <sup>(3)</sup>

1MHz-110MHz Devices



115.194001MHz -137MHz Devices



Notes: 3. Phase noise plots are measured with Agilent E5052B signal source analyzer. Integration range is 12kHz to 5MHz for carrier frequencies up to 40MHz.

# High Temperature, Programmable SMD MEMS Oscillator



ASTMHT



RoHS/RoHS II compliant

2.0 x 1.6 x 0.75mm; 2.5 x 2.0 x 0.75mm;  
3.2 x 2.5 x 0.75mm; 5.0 x 3.2 x 0.75mm;  
7.0 x 5.0 x 0.9mm

## OUTLINE DIMENSION:

### 2.0 x 1.6mm Package (Option "A")



### Recommended Land Pattern



### 2.5 x 2.0mm Package (Option "D")

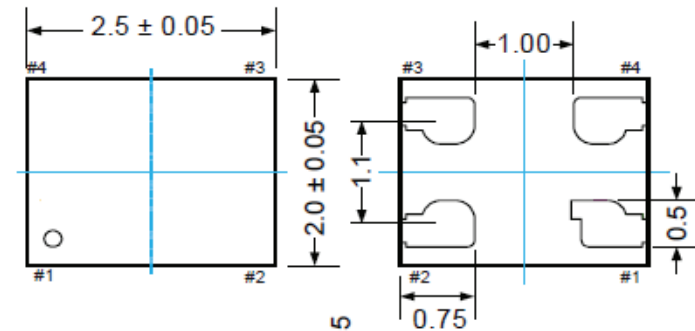

### Recommended Land Pattern

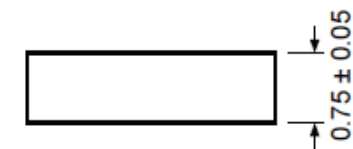
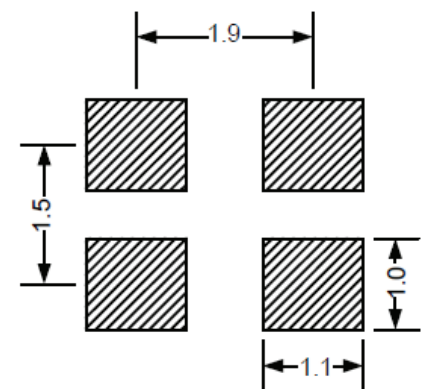

### 3.2 x 2.5mm Package (Option "E")

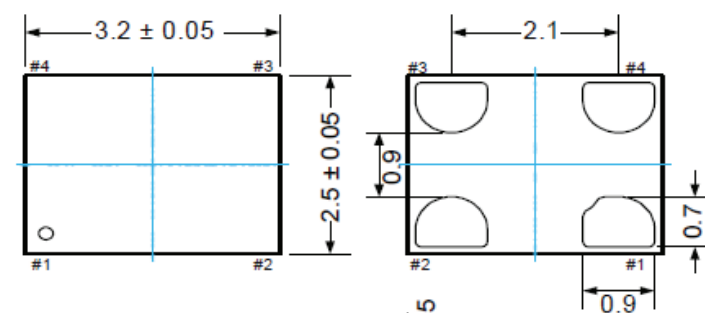

### Recommended Land Pattern

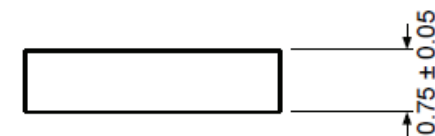
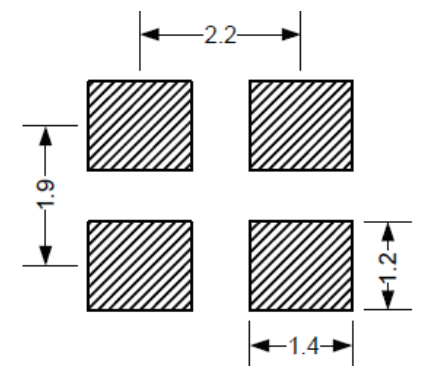

# High Temperature, Programmable SMD MEMS Oscillator



ASTMHT



RoHS/RoHS II compliant

2.0 x 1.6 x 0.75mm; 2.5 x 2.0 x 0.75mm;  
3.2 x 2.5 x 0.75mm; 5.0 x 3.2 x 0.75mm;  
7.0 x 5.0 x 0.9mm

## OUTLINE DIMENSION:

### 5.0 x 3.2mm Package (Option "FL")



### Recommended Land Pattern



### 7.0 x 5.0mm Package (Option "V")



### Recommended Land Pattern



Pin	Name		Functionality
1	OE/ $\overline{ST}$	Output Enable	H or Open <sup>(4)</sup> : specified frequency output L: output is high impedance. Only output driver is disabled
		Standby	H or Open <sup>(4)</sup> : specified frequency output L: output is low (weak pull down). Device goes to sleep mode. Supply current reduces to $I_{std}$ .
		No Connect	Any voltage between 0 and $V_{dd}$ or Open <sup>(4)</sup> : specified frequency output. Pin 1 has no function.
2	GND	Power	Electrical ground <sup>(5)</sup>
3	Out	Output	Oscillator clock output
4	$V_{dd}$	Power	Power supply voltage <sup>(5)</sup>

Notes: 4. In OE or  $\overline{ST}$  mode, a pull-up resistor of 10k $\Omega$  or less between OE/ $\overline{ST}$  pin and  $V_{dd}$  is recommended if pin 1 is not externally driven. If pin 1 needs to be left floating, use the NC option.  
5. A capacitor value of 0.1 $\mu$ F or higher between  $V_{dd}$  and GND is required.

Dimensions: mm

# High Temperature, Programmable SMD MEMS Oscillator



ASTMHT



RoHS/RoHS II compliant

2.0 x 1.6 x 0.75mm; 2.5 x 2.0 x 0.75mm;  
3.2 x 2.5 x 0.75mm; 5.0 x 3.2 x 0.75mm;  
7.0 x 5.0 x 0.9mm

## REFLOW PROFILE:



Item	Conditions
T <sub>S</sub> MAX to T <sub>L</sub> (Ramp-up Rate)	3°C/second max
Preheat	
Temperature Minimum (T <sub>S</sub> MIN)	150°C
Temperature Typical (T <sub>S</sub> TYP)	175°C
Temperature Maximum (T <sub>S</sub> MAX)	200°C
Time (t <sub>s</sub> )	60 – 180 seconds
Ramp-up Rate (T <sub>L</sub> to T <sub>P</sub> )	3°C/second max
Time Maintained Above	
Temperature (T <sub>L</sub> )	217°C
Time (t <sub>L</sub> )	60 – 150 seconds
Peak Temperature (T <sub>P</sub> )	260°C max
Target Peak Temperature (T <sub>P</sub> Target)	255°C
Time within 5°C of actual peak (t <sub>p</sub> )	20 – 40 seconds
Max. Number of Reflow Cycles	3
Ramp-down Rate	6°C/second max
Time 25°C to Peak Temperature (t)	8 minutes max

## TAPE & REEL:



Unit: mm

Device Size	D0	D1 min.	E1	E2 min.	F	P0	P1	P2
2016	1.55±0.05	0.9	1.75±0.1	6.05	3.5±0.05	4.0±0.1	4.0±0.1	2.0±0.05
2520	1.55±0.05	1.0	1.75±0.1	5.85	3.5±0.05	4.0±0.1	4.0±0.1	2.0±0.05
3225	1.5+0.1/-0.0	1.0	1.75±0.1	5.95	3.5±0.05	4.0±0.1	4.0±0.1	2.0±0.05
5032	1.5+0.1/-0.0	1.5	1.75±0.1	10.25	5.5±0.05	4.0±0.1	8.0±0.1	2.0±0.05
7050	1.5+0.1/-0.0	1.5	1.75±0.1	14.25	7.5±0.1	4.0±0.1	8.0±0.1	2.0±0.1

Unit: mm

Device Size	T	T1 max.	T2 max.	W max.	A0	B0	K0
2016	0.3±0.05	0.1	1.55	8.3	1.9±0.05	2.3±0.05	1.00±0.10
2520	0.3±0.05	0.1	1.65	8.3	2.25±0.05	2.8±0.05	1.10±0.10
3225	0.2±0.05	0.1	1.6	8.2	2.7±0.10	3.4±0.10	1.15±0.10
5032	0.6	0.1	1.65	12.3	3.5±0.10	5.3±0.10	1.10±0.10
7050	0.6	0.1	1.80	16.3	5.4±0.10	7.4±0.10	1.3±0.10

ABRACON IS  
ISO9001:2008  
CERTIFIED



5101 Hidden Creek Lane Spicewood TX 78669  
Phone: 512-371-6159 | Fax: 512-351-8858  
For terms and conditions of sales please visit:  
www.abracon.com

Revised: 06.17.2016

# High Temperature, Programmable SMD MEMS Oscillator



ASTMHT



RoHS/RoHS II compliant

2.0 x 1.6 x 0.75mm; 2.5 x 2.0 x 0.75mm;  
3.2 x 2.5 x 0.75mm; 5.0 x 3.2 x 0.75mm;  
7.0 x 5.0 x 0.9mm

## TAPE & REEL:



Unit: mm

Tape Size	A max.	B min.	C	D min.	N	W1	W2 max.
8mm	180	1.5	13.0+0.6/-0.2	20.2	60±0.5	8.4+1.5/-0	14.4
12mm	180	1.5	13.0±0.2	20.2	60±0.5	12.4+2.0/-0	18.4
	330	1.5	13.0±0.2	20.2	100±0.5	12.4+2.0/-0	18.4
16mm	180	1.5	13.0±0.2	20.2	60±0.5	16.4+2.0/-0	22.4
	330	1.5	13.0±0.2	20.2	100±0.5	16.4+2.0/-0	22.4

Device Size	"T" (1k/reel)		"T3" (3k/reel)	
2016	8mm Tape	7" Reel	8mm Tape	7" Reel
2520	8mm Tape	7" Reel	8mm Tape	7" Reel
3225	8mm Tape	7" Reel	8mm Tape	7" Reel
5032	12mm Tape	7" Reel	12mm Tape	13" Reel
7050	16mm Tape	7" Reel	16mm Tape	13" Reel

**ATTENTION:** Abracon Corporation's products are COTS – Commercial-Off-The-Shelf products; suitable for Commercial, Industrial and, where designated, Automotive Applications. Abracon's products are not specifically designed for Military, Aviation, Aerospace, Life-dependant Medical applications or any application requiring high reliability where component failure could result in loss of life and/or property. For applications requiring high reliability and/or presenting an extreme operating environment, written consent and authorization from Abracon Corporation is required. Please contact Abracon Corporation for more information.

ABRACON IS  
ISO9001:2008  
CERTIFIED



5101 Hidden Creek Lane Spicewood TX 78669  
Phone: 512-371-6159 | Fax: 512-351-8858  
For terms and conditions of sales please visit:  
[www.abracon.com](http://www.abracon.com)

Revised: 06.17.2016



Компания «ЭлектроПласт» предлагает заключение долгосрочных отношений при поставках импортных электронных компонентов на взаимовыгодных условиях!

Наши преимущества:

- Оперативные поставки широкого спектра электронных компонентов отечественного и импортного производства напрямую от производителей и с крупнейших мировых складов;
- Поставка более 17-ти миллионов наименований электронных компонентов;
- Поставка сложных, дефицитных, либо снятых с производства позиций;
- Оперативные сроки поставки под заказ (от 5 рабочих дней);
- Экспресс доставка в любую точку России;
- Техническая поддержка проекта, помощь в подборе аналогов, поставка прототипов;
- Система менеджмента качества сертифицирована по Международному стандарту ISO 9001;
- Лицензия ФСБ на осуществление работ с использованием сведений, составляющих государственную тайну;
- Поставка специализированных компонентов (Xilinx, Altera, Analog Devices, Intersil, Interpoint, Microsemi, Aeroflex, Peregrine, Syfer, Eurofarad, Texas Instrument, Miteq, Cobham, E2V, MA-COM, Hittite, Mini-Circuits, General Dynamics и др.);

Помимо этого, одним из направлений компании «ЭлектроПласт» является направление «Источники питания». Мы предлагаем Вам помощь Конструкторского отдела:

- Подбор оптимального решения, техническое обоснование при выборе компонента;
- Подбор аналогов;
- Консультации по применению компонента;
- Поставка образцов и прототипов;
- Техническая поддержка проекта;
- Защита от снятия компонента с производства.



#### Как с нами связаться

**Телефон:** 8 (812) 309 58 32 (многоканальный)

**Факс:** 8 (812) 320-02-42

**Электронная почта:** [org@eplast1.ru](mailto:org@eplast1.ru)

**Адрес:** 198099, г. Санкт-Петербург, ул. Калинина, дом 2, корпус 4, литера А.