

High Temperature, Programmable SMD MEMS Oscillator



2.0 x 1.6 x 0.75mm; 2.5 x 2.0 x 0.75mm;
3.2 x 2.5 x 0.75mm; 5.0 x 3.2 x 0.75mm;
7.0 x 5.0 x 0.9mm

ASTMHT



RoHS/RoHS II compliant

Moisture Sensitivity Level (MSL) – 1

FEATURES:

- Industry standard package sizes: 2.0 x 1.6 x 0.75mm, 2.5 x 2.0 x 0.75mm, 3.2 x 2.5 x 0.75mm, 5 x 3.2 x 0.75mm, 7.0 x 5.0 x 0.9mm
- Output frequency between 1MHz and 137MHz
- Supply voltage options: 3.3V, 3.0V, 2.8V, 2.5V, 1.8V, 2.25V ~ 3.63V
- Low current consumption: 3.5mA typ. (@20MHz, 1.8V, no load); 4.9mA typ. (@125MHz, 1.8V, no load)
- Wide operating temperature range options: -40 ~ +105°C; -40 ~ +125°C; -55 ~ +125°C
- Frequency stability options: ±20ppm, ±25ppm, ±30ppm, ±50ppm
- Factory programmable drive strength for improved jitter, reduced EMI or higher capacitive output load

APPLICATIONS:

- High temperature applications for Industrial, medical, non-automotive and avionics
- Harsh environment (vibration, shock-prone and humid)

STANDARD SPECIFICATIONS:

All electrical specifications are specified with 15pF output load and for all V_{dd}(s) unless otherwise stated. The typical value of any parameter in the table is specified for the nominal value of the highest voltage option for that parameter and at 25°C temperature.

| Parameters | Min | Typ | Max | Unit | Notes |
|---|--|-----|------------|------|---|
| Output Frequency Range (F) | 1.000000 | | 110.000000 | MHz | Available with operation temp. range option "X", "A" and "Z" |
| | 115.194001 | | 119.342000 | | Available with operation temp. range option "X" and "A" |
| | 119.342001 | | 137.000000 | | Available with operation temp. range option "X", "A" and "Z" |
| Standard Frequencies | See Section 1.1 for Standard Frequencies | | | MHz | |
| Frequency Stability (F _{stab}) | -20 | | +20 | ppm | Inclusive of initial tolerance at 25°C, 1 st year aging at 25°C, and variations over operating temperature, rated power supply voltage and load (15pF±10%) |
| | -25 | | +25 | | |
| | -30 | | +30 | | |
| | -50 | | +50 | | |
| Operating Temperature Range (T _{use}) | -40 | | +105 | °C | Option "X" |
| | -40 | | +125 | | Option "A" |
| | -55 | | +125 | | Option "Z" |
| Supply Voltage (V _{dd}) | 1.62 | 1.8 | 1.98 | V | Option "18" |
| | 2.25 | 2.5 | 2.75 | | Option "25" |
| | 2.52 | 2.8 | 3.08 | | Option "28" |
| | 2.7 | 3.0 | 3.3 | | Option "30" |
| | 2.97 | 3.3 | 3.63 | | Option "33" |
| | 2.25 | | 3.63 | | Option "Blank" (default) |
| Current Consumption (I _{dd}) | | 3.8 | 4.7 | mA | No load, F=20MHz, V _{dd} =2.8V,3.0V,3.3V |
| | | 3.6 | 4.5 | | No load, F=20MHz, V _{dd} =2.5V |
| | | 3.5 | 4.5 | | No load, F=20MHz, V _{dd} =1.8V |
| | | 6.2 | 8 | | No load, F=125MHz, V _{dd} =2.8V,3.0V,3.3V |
| | | 5.4 | 7 | | No load, F=125MHz, V _{dd} =2.5V |
| | | 4.9 | 6 | | No load, F=125MHz, V _{dd} =1.8V |
| OE Disable Current (I _{OD}) | | | 4.5 | mA | F=1MHz~110MHz, V _{dd} =2.5V-3.3V, OE=Low, output is in High-Z state |
| | | | 4.3 | | F=1MHz~110MHz, V _{dd} =1.8V, OE=Low, output is in High-Z state |
| | | | 4.7 | | F=115.194001MHz~110MHz, V _{dd} =2.5V-3.3V, OE=Low, output is in High-Z state |
| | | | 4.5 | | F=115.194001MHz~110MHz, V _{dd} =1.8V, OE=Low, output is in High-Z state |

ABRACON IS
ISO9001:2008
CERTIFIED



5101 Hidden Creek Lane Spicewood TX 78669
Phone: 512-371-6159 | Fax: 512-351-8858
For terms and conditions of sales please visit:
www.abracon.com

Revised: 06.17.2016

High Temperature, Programmable SMD MEMS Oscillator



ASTMHT



RoHS/RoHS II compliant

2.0 x 1.6 x 0.75mm; 2.5 x 2.0 x 0.75mm;
3.2 x 2.5 x 0.75mm; 5.0 x 3.2 x 0.75mm;
7.0 x 5.0 x 0.9mm

(Continued)

| Parameters | Min | Typ | Max | Unit | Notes |
|---|---------------|-----|---------------|------------|---|
| Standby Current (I_{std}) | | 2.6 | 8.5 | μ A | \overline{ST} =Low, V_{dd} =2.8V-3.3V, output is weakly pulled down |
| | | 1.4 | 5.5 | | \overline{ST} =Low, V_{dd} =2.5V, output is weakly pulled down |
| | | 0.6 | 4.0 | | \overline{ST} =Low, V_{dd} =1.8V, output is weakly pulled down |
| Output Type | LVCMOS | | | | |
| Duty Cycle | 45 | | 55 | % | All V_{dd} options |
| Rise/Fall Time (T_r/T_f) | | 1 | 2 | ns | V_{dd} =2.5V, 2.8V, 3.0V or 3.3V, 20%-80% |
| | | 1.3 | 2.5 | | V_{dd} =1.8V, 20%-80% |
| | | 1 | 3 | | V_{dd} =2.25V-3.63V, 20%-80% |
| Output High Voltage (V_{OH}) | 90%* V_{dd} | | | V | I_{OH} =-4mA (V_{dd} =3.0V or 3.3V) |
| | | | | | I_{OH} =-3mA (V_{dd} =2.8V or 2.5V) |
| | | | | | I_{OH} =-2mA (V_{dd} =1.8V) |
| Output Low Voltage (V_{OL}) | | | 10%* V_{dd} | V | I_{OL} =4mA (V_{dd} =3.0V or 3.3V) |
| | | | | | I_{OL} =3mA (V_{dd} =2.8V or 2.5V) |
| | | | | | I_{OL} =2mA (V_{dd} =1.8V) |
| Input High Voltage(V_{IH}) | 70%* V_{dd} | | | V | Pin 1 |
| Input Low Voltage(V_{IL}) | | | 30%* V_{dd} | V | Pin 1 |
| Input Pull-up Impedance (Z_{in}) | 50 | 87 | 150 | k Ω | Pin 1, OE logic high or logic low, \overline{ST} logic high |
| | 2 | | | M Ω | Pin 1, \overline{ST} logic low |
| Startup Time (T_{start}) | | | 5 | ms | Measured from the time V_{dd} reaches 90% of its final value |
| Enable/Disable Time (T_{oe}) | | | 130 | ns | F=110MHz, 115.194001MHz, 119.342001MHz. For other frequencies, T_{oe} =100ns+3*cycles |
| Resume Time (T_{resume}) | | | 5 | ms | Measured from the time \overline{ST} pin crosses 50% threshold |
| RMS Period Jitter (T_{jitt}) | | 1.6 | 2.5 | ps | F=75MHz, 125MHz, V_{dd} =2.5V, 2.8V, 3.0V or 3.3V |
| | | 1.9 | 3 | | F=75MHz, 125MHz, V_{dd} =1.8V |
| Peak-to-peak Period Jitter (T_{pk}) | | 12 | 20 | ps | F=75MHz, 125MHz, V_{dd} =2.5V, 2.8V, 3.0V or 3.3V |
| | | 14 | 25 | | F=75MHz, 125MHz, V_{dd} =1.8V |
| RMS Phase Jitter (random) (T_{phj}) | | 0.5 | 0.8 | ps | F=75MHz, 125MHz integration bandwidth=900kHz to 7.5MHz |
| | | 1.3 | 2 | | F=75MHz, 125MHz integration bandwidth=12kHz to 20MHz |

High Temperature, Programmable SMD MEMS Oscillator



2.0 x 1.6 x 0.75mm; 2.5 x 2.0 x 0.75mm;
3.2 x 2.5 x 0.75mm; 5.0 x 3.2 x 0.75mm;
7.0 x 5.0 x 0.9mm

ASTMHT



RoHS/RoHS II compliant

Standard Frequency (MHz)

| Standard Frequency (MHz) | | | | | | | | |
|--------------------------|----------|----------|---------|---------|---------|--------|--------|---------|
| 7.3728 | 8 | 8.192 | 9.8304 | 9.84375 | 11.0592 | 12 | 12.288 | 13 |
| 13.225625 | 13.52127 | 14.31818 | 14.7456 | 15 | 16 | 16.384 | 18.432 | 19.6608 |
| 20 | 22.1184 | 24 | 24.56 | 24.576 | 25 | 26 | 27 | 29.4912 |
| 30 | 32 | 33 | 36 | 40 | 48 | | | |

Absolute Maximum Ratings

Attempted operation outside the absolute maximum ratings may cause permanent damage to the part. Actual performance of the IC is only guaranteed within the operational specifications, not at absolute maximum ratings.

| Parameters | Min. | Max. | Unit |
|---|------|------|------|
| Storage Temperature | -65 | 150 | °C |
| V _{DD} | -0.5 | 4 | V |
| Electrostatic Discharge (HBM) | | 2000 | V |
| Soldering Temperature (follow standard Pb free soldering guidelines) | | 260 | °C |
| Junction Temperature ⁽¹⁾ | | 150 | °C |

Note: 1. Exceeding this temperature for extended period of time may damage the device

Thermal Consideration

| Package | θJA, 4 Layer Board (°C/W) | θJA, 2 Layer Board (°C/W) | θJC, Bottom (°C/W) |
|-------------|------------------------------|------------------------------|-----------------------|
| 7.0 x 5.0mm | 142 | 273 | 30 |
| 5.0 x 3.2mm | 97 | 199 | 24 |
| 3.2 x 2.5mm | 109 | 212 | 27 |
| 2.5 x 2.0mm | 117 | 222 | 26 |
| 2.0 x 1.6mm | 152 | 252 | 36 |

Maximum Operating Junction Temperature ⁽²⁾

| Max. Operating Temperature (ambient) | Max. Operating Junction Temperature |
|--------------------------------------|-------------------------------------|
| 105°C | 115°C |
| 125°C | 135°C |

Note: 2. Datasheet specifications are not guaranteed if junction temperature exceeds the maximum operating junction temperature

High Temperature, Programmable SMD MEMS Oscillator



2.0 x 1.6 x 0.75mm; 2.5 x 2.0 x 0.75mm;
3.2 x 2.5 x 0.75mm; 5.0 x 3.2 x 0.75mm;
7.0 x 5.0 x 0.9mm

ASTMHT



RoHS/RoHS II compliant

PART IDENTIFICATION:

ASTMHT [] - [] - [] MHz - [] [] - [] [] - []

| Package Size |
|---------------|
| A: 2.0x1.6mm |
| D: 2.5x2.0mm |
| E: 3.2x2.5mm |
| FL: 5.0x3.2mm |
| V: 7.0x5.0mm |

| Output Frequency in MHz |
|-------------------------|
| e.g. 7.3728, 125.000 |

| Operating Temp. |
|-------------------|
| X: -40°C ~ +105°C |
| A: -40°C ~ +125°C |
| Z: -55°C ~ +125°C |

| Pin 1 Function |
|------------------|
| E: Output Enable |
| S: Standby |
| N: No Connect |

| Packaging |
|--------------------------------|
| Blank: Bulk |
| T: Tape & Reel (1kpcs / reel) |
| T3: Tape & Reel (3kpcs / reel) |

| Supply Voltage |
|--------------------|
| Blank: 2.25V~3.63V |
| 18: 1.8V±10% |
| 25: 2.5V±10% |
| 28: 2.8V±10% |
| 30: 3.0V±10% |
| 33: 3.3V±10% |

| Freq. Stability |
|-----------------|
| J: ±20ppm |
| R: ±25 ppm |
| K: ±30ppm |
| C: ±50 ppm |

| Output Drive Strength* |
|------------------------|
| Blank: Default |
| L** |
| A** |
| R |
| B |
| T |
| E |
| U |
| F |

* See Table 1 to 5 for the Rise/Fall times at different drive strength and available options

** Only available for F=1MHz~110MHz

| List of Supported Frequency Ranges (MHz) | | | |
|--|------------|--------------|------------|
| -40°C~+105°C/-40°C~+125°C | | -55°C~+125°C | |
| Min | Max | Min | Max |
| 1.000000 | 61.222999 | 1.000000 | 61.222999 |
| 61.974001 | 69.795999 | 61.674001 | 69.239999 |
| 70.485001 | 79.062999 | 70.827001 | 78.714999 |
| 79.162001 | 81.427999 | 79.561001 | 80.159999 |
| 82.232001 | 91.833999 | 80.174001 | 80.779999 |
| 92.155001 | 94.248999 | 82.632001 | 91.833999 |
| 94.430001 | 94.874999 | 95.474001 | 96.191999 |
| 94.994001 | 97.713999 | 96.209001 | 96.935999 |
| 98.679001 | 110.000000 | 99.158001 | 110.000000 |
| 115.194001 | 117.810999 | 119.342001 | 120.238999 |
| 118.038001 | 118.593999 | 120.262001 | 121.169999 |
| 118.743001 | 122.141999 | 121.243001 | 121.600999 |
| 122.705001 | 123.021999 | 123.948001 | 137.000000 |
| 123.348001 | 137.000000 | | |

High Temperature, Programmable SMD MEMS Oscillator

ASTMHT



RoHS/RoHS II compliant



2.0 x 1.6 x 0.75mm; 2.5 x 2.0 x 0.75mm;
3.2 x 2.5 x 0.75mm; 5.0 x 3.2 x 0.75mm;
7.0 x 5.0 x 0.9mm

Table 1: $V_{dd}=1.8V$ Rise/Fall Times for Specific C_{LOAD}

(a) Output Frequency: 1MHz – 110MHz

| Drive Strength Options | Rise/Fall Time Typ. (ns) | | | | |
|------------------------|--------------------------|-------|-------|-------|-------|
| | C_{LOAD} | | | | |
| | 5pF | 15pF | 30pF | 45pF | 60pF |
| L | 6.16 | 11.61 | 22.00 | 31.27 | 39.91 |
| A | 3.19 | 6.35 | 11.00 | 16.01 | 21.52 |
| R | 2.11 | 4.31 | 7.65 | 10.77 | 14.47 |
| B | 1.65 | 3.23 | 5.79 | 8.18 | 11.08 |
| T | 0.93 | 1.91 | 3.32 | 4.66 | 6.48 |
| E | 0.78 | 1.66 | 2.94 | 4.09 | 5.74 |
| U | 0.70 | 1.48 | 2.64 | 3.68 | 5.09 |
| F or Blank (default) | 0.65 | 1.30 | 2.40 | 3.35 | 4.56 |

(b) Output Frequency: 115.194001MHz – 137MHz

| Drive Strength Options | Rise/Fall Time Typ. (ns) | |
|------------------------|--------------------------|------|
| | C_{LOAD} | |
| | 5pF | 15pF |
| T | 0.93 | N/A |
| E | 0.78 | N/A |
| U | 0.70 | 1.48 |
| F or Blank (default) | 0.65 | 1.30 |

Table 2: $V_{dd}=2.5V$ Rise/Fall Times for Specific C_{LOAD}

(a) Output Frequency: 1MHz – 110MHz

| Drive Strength Options | Rise/Fall Time Typ. (ns) | | | | |
|------------------------|--------------------------|------|-------|-------|-------|
| | C_{LOAD} | | | | |
| | 5pF | 15pF | 30pF | 45pF | 60pF |
| L | 4.13 | 8.25 | 12.82 | 21.45 | 27.79 |
| A | 2.11 | 4.27 | 7.64 | 11.20 | 14.49 |
| R | 1.45 | 2.81 | 5.16 | 7.65 | 9.88 |
| B | 1.09 | 2.20 | 3.88 | 5.86 | 7.57 |
| T | 0.62 | 1.28 | 2.27 | 3.51 | 4.45 |
| E or Blank (default) | 0.54 | 1.00 | 2.01 | 3.10 | 4.01 |
| U | 0.43 | 0.96 | 1.81 | 2.79 | 3.65 |
| F | 0.34 | 0.88 | 1.64 | 2.54 | 3.32 |

(b) Output Frequency: 115.194001MHz – 137MHz

| Drive Strength Options | Rise/Fall Time Typ. (ns) | |
|------------------------|--------------------------|------|
| | C_{LOAD} | |
| | 5pF | 15pF |
| R | 1.45 | N/A |
| B | 1.09 | N/A |
| T | 0.62 | 1.28 |
| E or Blank (default) | 0.54 | 1.00 |
| U | 0.43 | 0.96 |
| F | 0.34 | 0.88 |

Table 3: $V_{dd}=2.8V$ Rise/Fall Times for Specific C_{LOAD}

(a) Output Frequency: 1MHz – 110MHz

| Drive Strength Options | Rise/Fall Time Typ. (ns) | | | | |
|------------------------|--------------------------|------|-------|-------|-------|
| | C_{LOAD} | | | | |
| | 5pF | 15pF | 30pF | 45pF | 60pF |
| L | 3.77 | 7.54 | 12.28 | 19.57 | 25.27 |
| A | 1.94 | 3.90 | 7.03 | 10.24 | 13.34 |
| R | 1.29 | 2.57 | 4.72 | 7.01 | 9.06 |
| B | 0.97 | 2.00 | 3.54 | 5.43 | 6.93 |
| T | 0.55 | 1.12 | 2.08 | 3.22 | 4.08 |
| E or Blank (default) | 0.44 | 1.00 | 1.83 | 2.82 | 3.67 |
| U | 0.34 | 0.88 | 1.64 | 2.52 | 3.30 |
| F | 0.29 | 0.81 | 1.48 | 2.29 | 2.99 |

(b) Output Frequency: 115.194001MHz – 137MHz

| Drive Strength Options | Rise/Fall Time Typ. (ns) | | |
|------------------------|--------------------------|------|------|
| | C_{LOAD} | | |
| | 5pF | 15pF | 30pF |
| R | 1.29 | N/A | N/A |
| B | 0.97 | N/A | N/A |
| T | 0.55 | 1.12 | N/A |
| E or Blank (default) | 0.44 | 1.00 | N/A |
| U | 0.34 | 0.88 | N/A |
| F | 0.29 | 0.81 | 1.48 |



TYPICAL PERFORMANCE DATA

Table 4: V_{dd}=3.0V Rise/Fall Times for Specific C_{LOAD}

(a) Output Frequency: 1MHz – 110MHz

| Drive Strength Options | Rise/Fall Time Typ. (ns) | | | | |
|------------------------|--------------------------|------|-------|-------|-------|
| | C _{LOAD} | | | | |
| | 5pF | 15pF | 30pF | 45pF | 60pF |
| L | 3.60 | 7.21 | 11.97 | 18.74 | 24.30 |
| A | 1.84 | 3.71 | 6.72 | 9.86 | 12.68 |
| R | 1.22 | 2.46 | 4.54 | 6.76 | 8.62 |
| B | 0.89 | 1.92 | 3.39 | 5.20 | 6.64 |
| T or Blank (default) | 0.51 | 1.00 | 1.97 | 3.07 | 3.90 |
| E | 0.38 | 0.92 | 1.72 | 2.71 | 3.51 |
| U | 0.30 | 0.83 | 1.55 | 2.40 | 3.13 |
| F | 0.27 | 0.76 | 1.39 | 2.16 | 2.85 |

(b) Output Frequency: 115.194001MHz – 137MHz

| Drive Strength Options | Rise/Fall Time Typ. (ns) | | |
|------------------------|--------------------------|------|------|
| | C _{LOAD} | | |
| | 5pF | 15pF | 30pF |
| R | 1.22 | N/A | N/A |
| B | 0.89 | N/A | N/A |
| T or Blank (default) | 0.51 | 1.00 | N/A |
| E | 0.38 | 0.92 | N/A |
| U | 0.30 | 0.83 | N/A |
| F | 0.27 | 0.76 | 1.39 |

Table 5: V_{dd}=3.3V Rise/Fall Times for Specific C_{LOAD}

(a) Output Frequency: 1MHz – 110MHz

| Drive Strength Options | Rise/Fall Time Typ. (ns) | | | | |
|------------------------|--------------------------|------|-------|-------|-------|
| | C _{LOAD} | | | | |
| | 5pF | 15pF | 30pF | 45pF | 60pF |
| L | 3.39 | 6.88 | 11.63 | 17.56 | 23.59 |
| A | 1.74 | 3.50 | 6.38 | 8.98 | 12.19 |
| R | 1.16 | 2.33 | 4.29 | 6.04 | 8.34 |
| B | 0.81 | 1.82 | 3.22 | 4.52 | 6.33 |
| T or Blank (default) | 0.46 | 1.00 | 1.86 | 2.60 | 3.84 |
| E | 0.33 | 0.87 | 1.64 | 2.30 | 3.35 |
| U | 0.28 | 0.79 | 1.46 | 2.05 | 2.93 |
| F | 0.25 | 0.72 | 1.31 | 1.83 | 2.61 |

(b) Output Frequency: 115.194001MHz – 137MHz

| Drive Strength Options | Rise/Fall Time Typ. (ns) | | |
|------------------------|--------------------------|------|------|
| | C _{LOAD} | | |
| | 5pF | 15pF | 30pF |
| R | 1.16 | N/A | N/A |
| B | 0.81 | N/A | N/A |
| T or Blank (default) | 0.46 | 1.00 | N/A |
| E | 0.33 | 0.87 | N/A |
| U | 0.28 | 0.79 | 1.46 |
| F | 0.25 | 0.72 | 1.31 |

Calculating Maximum Frequency

Based on the rise and fall time data given in Table 1 through 5, the maximum frequency the oscillator can operate with a guaranteed full swing of the output voltage over temperature is calculated as follows:

$$Max. Frequency = \frac{1}{5 \times T_{r/f}}$$

Example:

Calculate F_{max} of a 1MHz ~ 110MHz device with the following condition:

- V_{dd} = 1.8V (Table 1)
- Capacitive Load = 30pF
- Desired T_{r/f} Time: = 3ns (rise/fall time option code “E”)

The F_{max} is 66.66666MHz.

High Temperature, Programmable SMD MEMS Oscillator



ASTMHT



RoHS/RoHS II compliant

2.0 x 1.6 x 0.75mm; 2.5 x 2.0 x 0.75mm;
3.2 x 2.5 x 0.75mm; 5.0 x 3.2 x 0.75mm;
7.0 x 5.0 x 0.9mm

TYPICAL PERFORMANCE DATA

All plots are measured with 15pF load at room temperature, unless otherwise stated.

I_{DD} vs. Frequency

1MHz-110MHz Devices

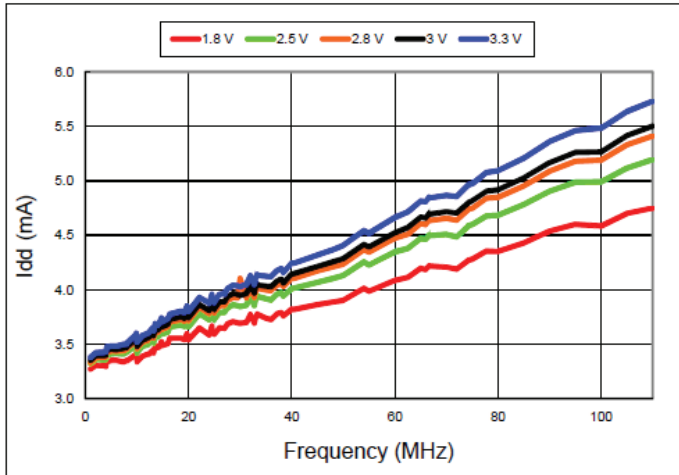

115.194001MHz -137MHz Devices

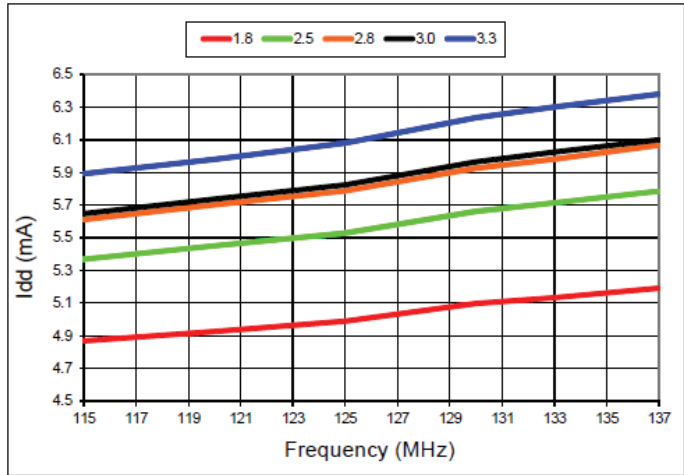

Frequency vs. Temperature

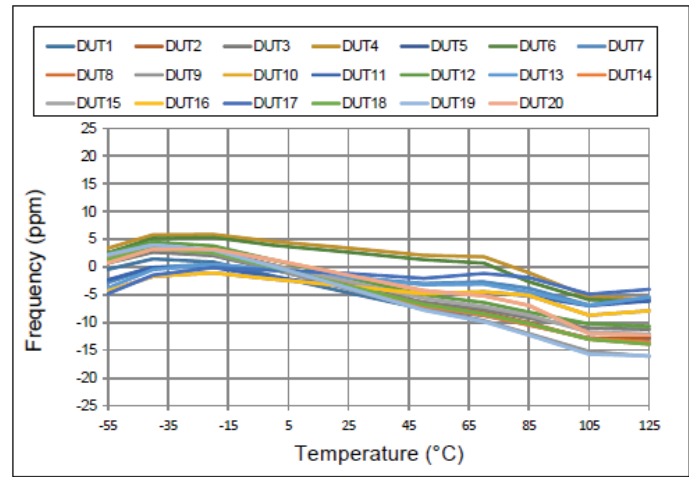
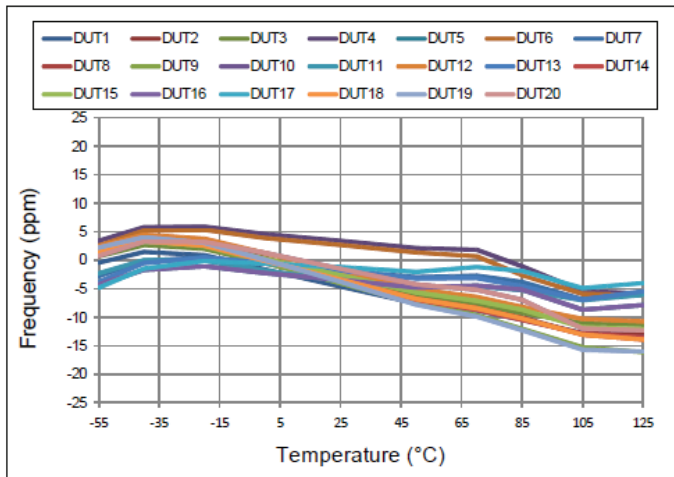

High Temperature, Programmable SMD MEMS Oscillator



ASTMHT



RoHS/RoHS II compliant

2.0 x 1.6 x 0.75mm; 2.5 x 2.0 x 0.75mm;
3.2 x 2.5 x 0.75mm; 5.0 x 3.2 x 0.75mm;
7.0 x 5.0 x 0.9mm

TYPICAL PERFORMANCE DATA

RMS Period Jitter vs. Frequency

1MHz-110MHz Devices

115.194001MHz -137MHz Devices

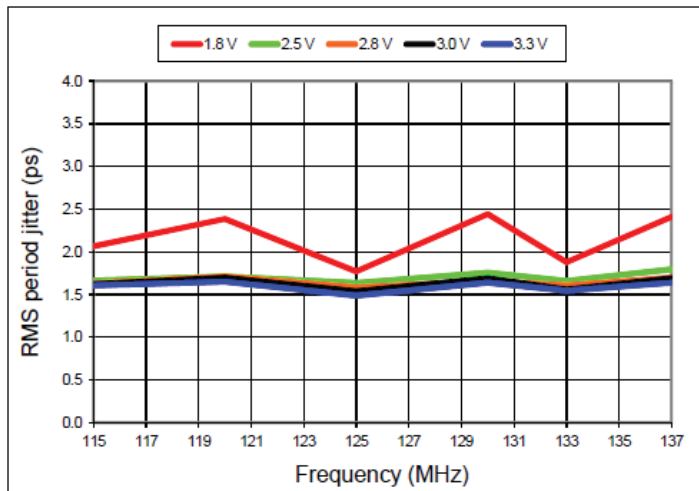
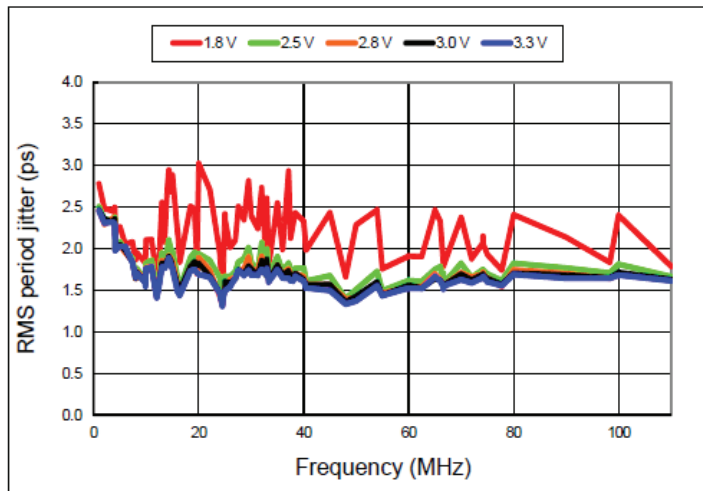

Duty Cycle vs. Frequency

1MHz-110MHz Devices

115.194001MHz -137MHz Devices

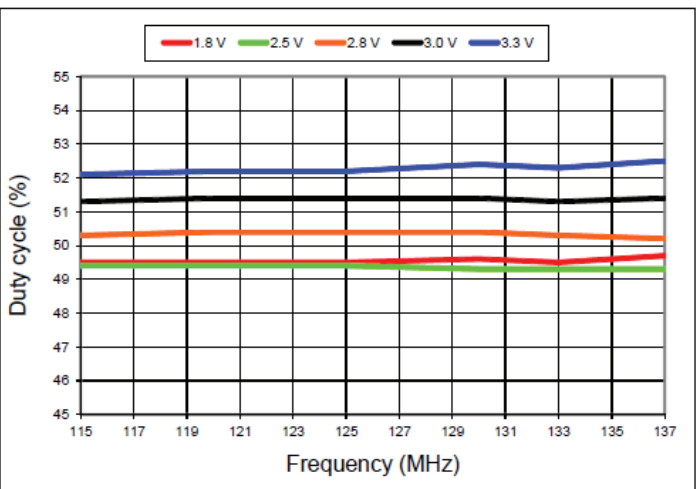
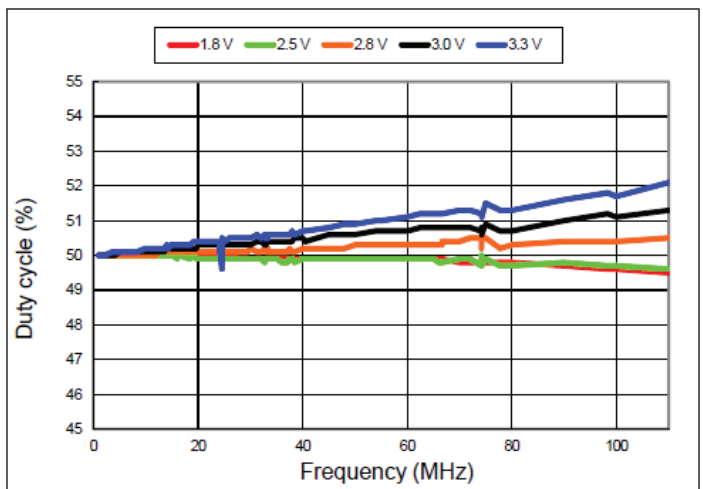

High Temperature, Programmable SMD MEMS Oscillator



ASTMHT



RoHS/RoHS II compliant

2.0 x 1.6 x 0.75mm; 2.5 x 2.0 x 0.75mm;
3.2 x 2.5 x 0.75mm; 5.0 x 3.2 x 0.75mm;
7.0 x 5.0 x 0.9mm

TYPICAL PERFORMANCE DATA

20% - 80% Rise Time vs. Temperature

1MHz-110MHz Devices

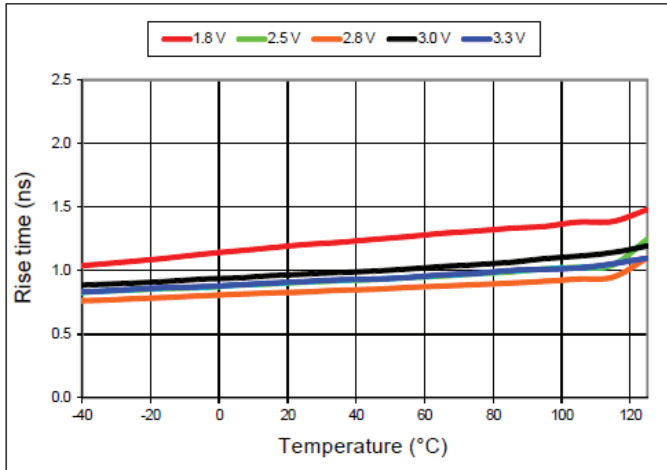

115.194001MHz -137MHz Devices

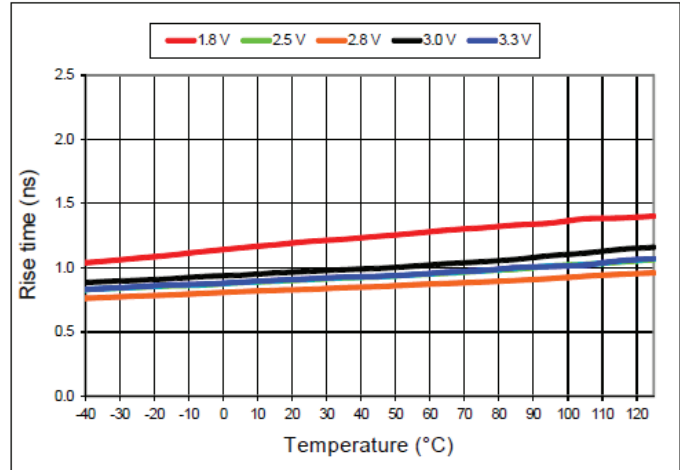

20% - 80% Fall Time vs. Temperature

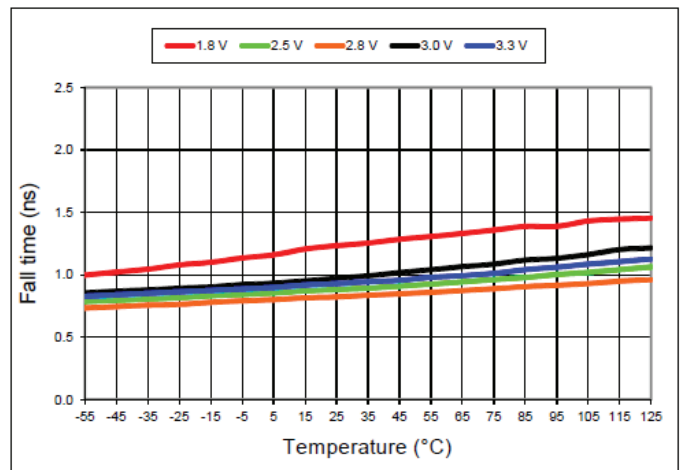
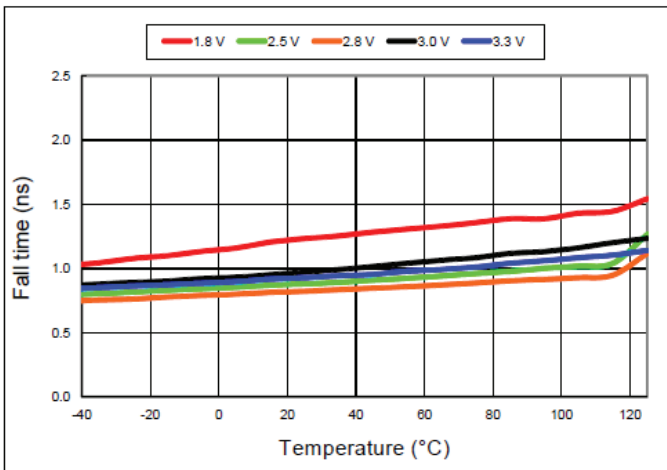

High Temperature, Programmable SMD MEMS Oscillator



ASTMHT



RoHS/RoHS II compliant

2.0 x 1.6 x 0.75mm; 2.5 x 2.0 x 0.75mm;
3.2 x 2.5 x 0.75mm; 5.0 x 3.2 x 0.75mm;
7.0 x 5.0 x 0.9mm

TYPICAL PERFORMANCE DATA

RMS Integrated Phase Jitter Random (12kHz to 20MHz) vs Frequency ⁽³⁾

1MHz-110MHz Devices

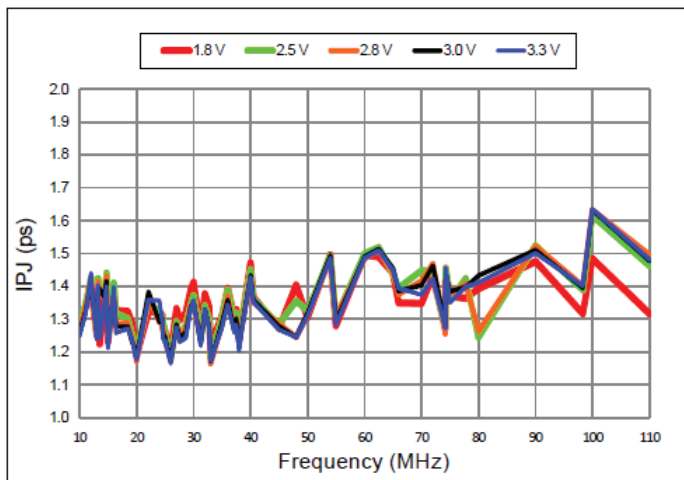

115.194001MHz -137MHz Devices

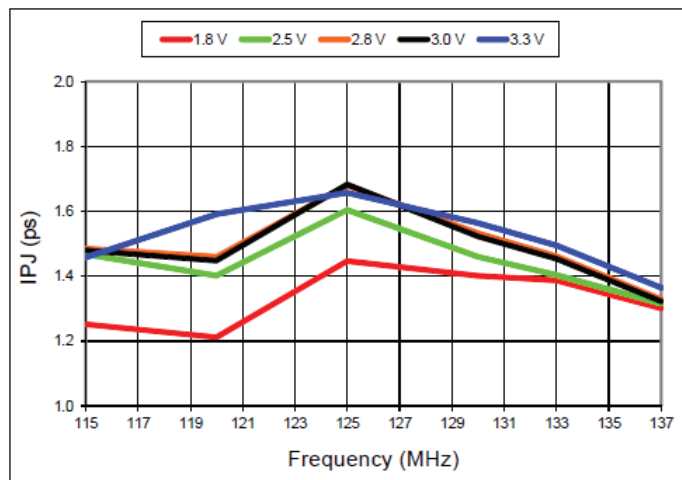

RMS Integrated Phase Jitter Random (900kHz to 7.5MHz) vs Frequency ⁽³⁾

1MHz-110MHz Devices

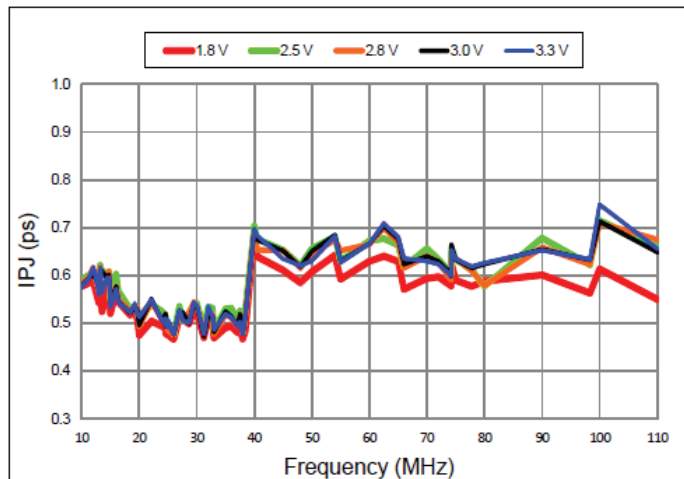

115.194001MHz -137MHz Devices

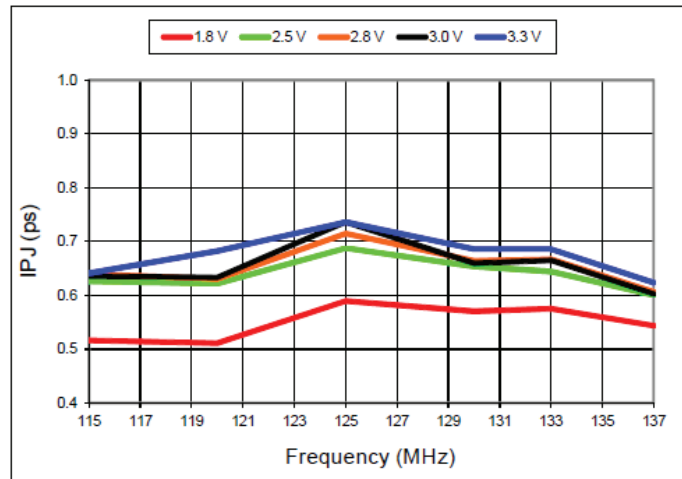

Notes: 3. Phase noise plots are measured with Agilent E5052B signal source analyzer. Integration range is 12kHz to 5MHz for carrier frequencies up to 40MHz.

High Temperature, Programmable SMD MEMS Oscillator



ASTMHT



RoHS/RoHS II compliant

2.0 x 1.6 x 0.75mm; 2.5 x 2.0 x 0.75mm;
3.2 x 2.5 x 0.75mm; 5.0 x 3.2 x 0.75mm;
7.0 x 5.0 x 0.9mm

OUTLINE DIMENSION:

2.0 x 1.6mm Package (Option "A")

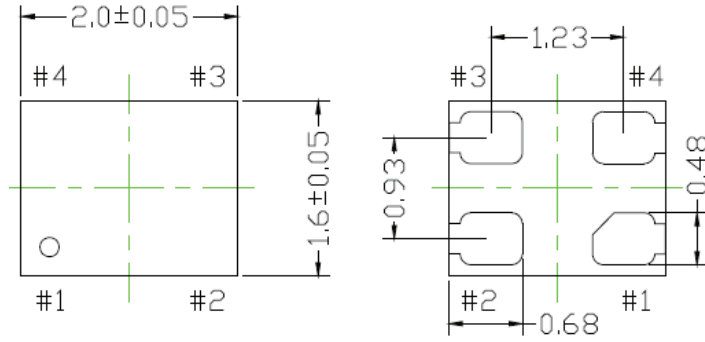

Recommended Land Pattern

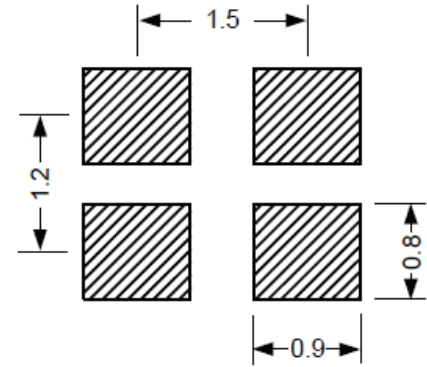

2.5 x 2.0mm Package (Option "D")

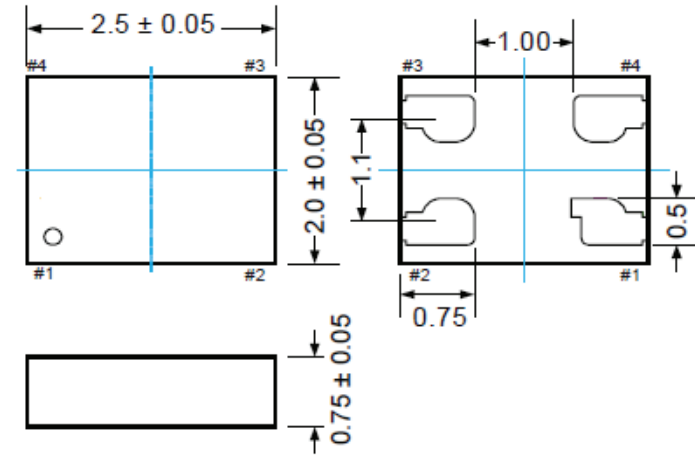

Recommended Land Pattern

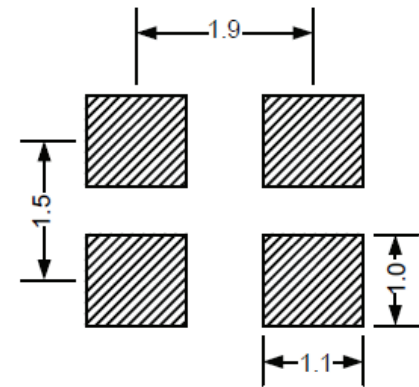

3.2 x 2.5mm Package (Option "E")

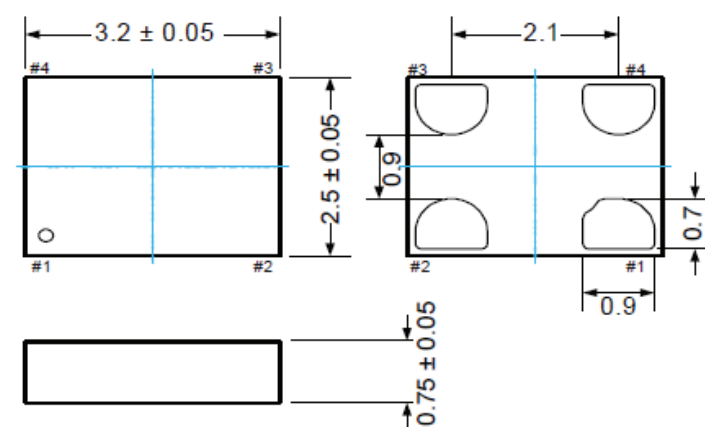

Recommended Land Pattern

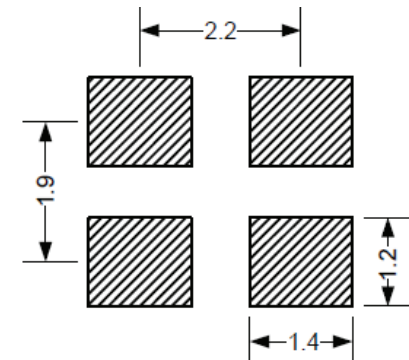

High Temperature, Programmable SMD MEMS Oscillator



ASTMHT



RoHS/RoHS II compliant

2.0 x 1.6 x 0.75mm; 2.5 x 2.0 x 0.75mm;
3.2 x 2.5 x 0.75mm; 5.0 x 3.2 x 0.75mm;
7.0 x 5.0 x 0.9mm

OUTLINE DIMENSION:

5.0 x 3.2mm Package (Option "FL")

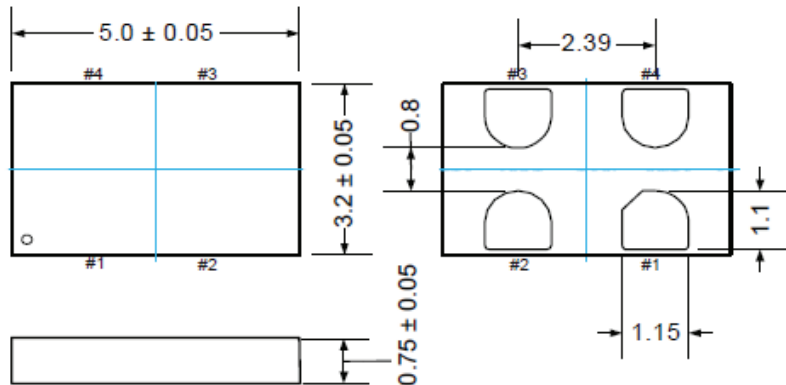

Recommended Land Pattern

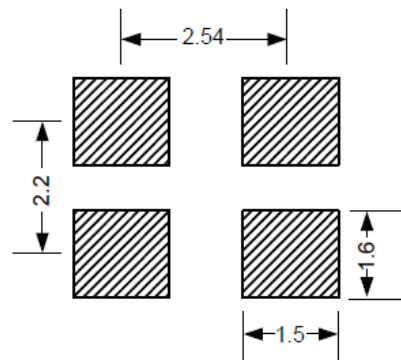

7.0 x 5.0mm Package (Option "V")

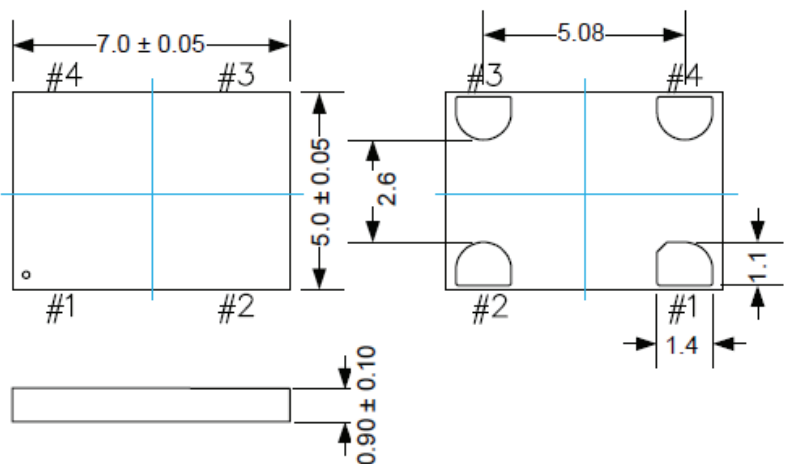

Recommended Land Pattern

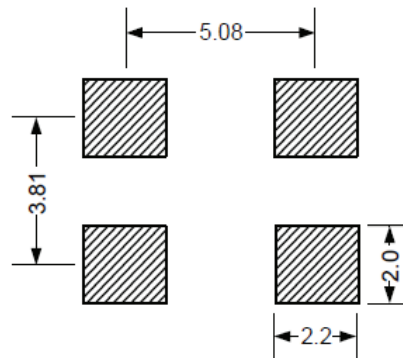

| Pin | Name | Functionality |
|-----|---------------------|---|
| 1 | OE/ \overline{ST} | Output Enable H or Open ⁽⁴⁾ : specified frequency output L: output is high impedance. Only output driver is disabled |
| | | Standby H or Open ⁽⁴⁾ : specified frequency output L: output is low (weak pull down). Device goes to sleep mode. Supply current reduces to I_{std} . |
| | | No Connect Any voltage between 0 and V_{dd} or Open ⁽⁴⁾ : specified frequency output. Pin 1 has no function. |
| 2 | GND | Power Electrical ground ⁽⁵⁾ |
| 3 | Out | Output Oscillator clock output |
| 4 | V_{dd} | Power Power supply voltage ⁽⁵⁾ |

Notes: 4. In OE or \overline{ST} mode, a pull-up resistor of 10k Ω or less between OE/ \overline{ST} pin and V_{dd} is recommended if pin 1 is not externally driven. If pin 1 needs to be left floating, use the NC option.
5. A capacitor value of 0.1 μ F or higher between V_{dd} and GND is required.

Dimensions: mm

High Temperature, Programmable SMD MEMS Oscillator



ASTMHT



RoHS/RoHS II compliant

2.0 x 1.6 x 0.75mm; 2.5 x 2.0 x 0.75mm;
3.2 x 2.5 x 0.75mm; 5.0 x 3.2 x 0.75mm;
7.0 x 5.0 x 0.9mm

REFLOW PROFILE:

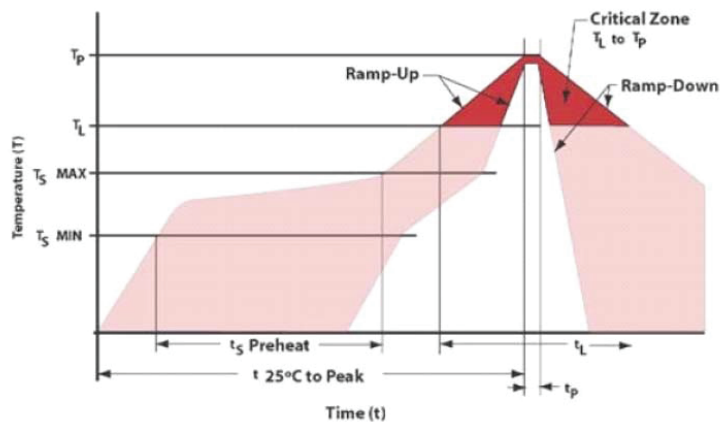

| Item | Conditions |
|--|------------------|
| T_S MAX to T_L (Ramp-up Rate) | 3°C/second max |
| Preheat | |
| Temperature Minimum (T_S MIN) | 150°C |
| Temperature Typical (T_S TYP) | 175°C |
| Temperature Maximum (T_S MAX) | 200°C |
| Time (t_s) | 60 – 180 seconds |
| Ramp-up Rate (T_L to T_P) | 3°C/second max |
| Time Maintained Above | |
| Temperature (T_L) | 217°C |
| Time (t_L) | 60 – 150 seconds |
| Peak Temperature (T_P) | 260°C max |
| Target Peak Temperature (T_P Target) | 255°C |
| Time within 5°C of actual peak (t_p) | 20 – 40 seconds |
| Max. Number of Reflow Cycles | 3 |
| Ramp-down Rate | 6°C/second max |
| Time 25°C to Peak Temperature (t) | 8 minutes max |

TAPE & REEL:

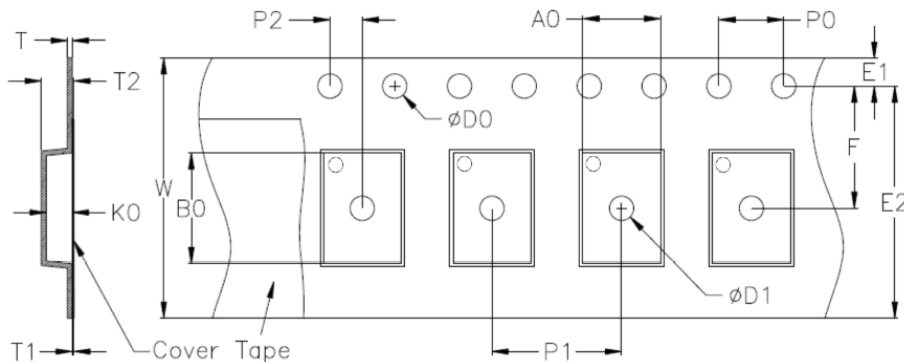

Unit: mm

| Device Size | D0 | D1 min. | E1 | E2 min. | F | P0 | P1 | P2 |
|-------------|--------------|---------|----------|---------|----------|---------|---------|----------|
| 2016 | 1.55±0.05 | 0.9 | 1.75±0.1 | 6.05 | 3.5±0.05 | 4.0±0.1 | 4.0±0.1 | 2.0±0.05 |
| 2520 | 1.55±0.05 | 1.0 | 1.75±0.1 | 5.85 | 3.5±0.05 | 4.0±0.1 | 4.0±0.1 | 2.0±0.05 |
| 3225 | 1.5+0.1/-0.0 | 1.0 | 1.75±0.1 | 5.95 | 3.5±0.05 | 4.0±0.1 | 4.0±0.1 | 2.0±0.05 |
| 5032 | 1.5+0.1/-0.0 | 1.5 | 1.75±0.1 | 10.25 | 5.5±0.05 | 4.0±0.1 | 8.0±0.1 | 2.0±0.05 |
| 7050 | 1.5+0.1/-0.0 | 1.5 | 1.75±0.1 | 14.25 | 7.5±0.1 | 4.0±0.1 | 8.0±0.1 | 2.0±0.1 |

Unit: mm

| Device Size | T | T1 max. | T2 max. | W max. | A0 | B0 | K0 |
|-------------|----------|---------|---------|--------|-----------|----------|-----------|
| 2016 | 0.3±0.05 | 0.1 | 1.55 | 8.3 | 1.9±0.05 | 2.3±0.05 | 1.00±0.10 |
| 2520 | 0.3±0.05 | 0.1 | 1.65 | 8.3 | 2.25±0.05 | 2.8±0.05 | 1.10±0.10 |
| 3225 | 0.2±0.05 | 0.1 | 1.6 | 8.2 | 2.7±0.10 | 3.4±0.10 | 1.15±0.10 |
| 5032 | 0.6 | 0.1 | 1.65 | 12.3 | 3.5±0.10 | 5.3±0.10 | 1.10±0.10 |
| 7050 | 0.6 | 0.1 | 1.80 | 16.3 | 5.4±0.10 | 7.4±0.10 | 1.3±0.10 |

ABRACON IS
ISO9001:2008
CERTIFIED



5101 Hidden Creek Lane Spicewood TX 78669
Phone: 512-371-6159 | Fax: 512-351-8858
For terms and conditions of sales please visit:
www.abracon.com

Revised: 06.17.2016

High Temperature, Programmable SMD MEMS Oscillator



ASTMHT



RoHS/RoHS II compliant

2.0 x 1.6 x 0.75mm; 2.5 x 2.0 x 0.75mm;
3.2 x 2.5 x 0.75mm; 5.0 x 3.2 x 0.75mm;
7.0 x 5.0 x 0.9mm

TAPE & REEL:

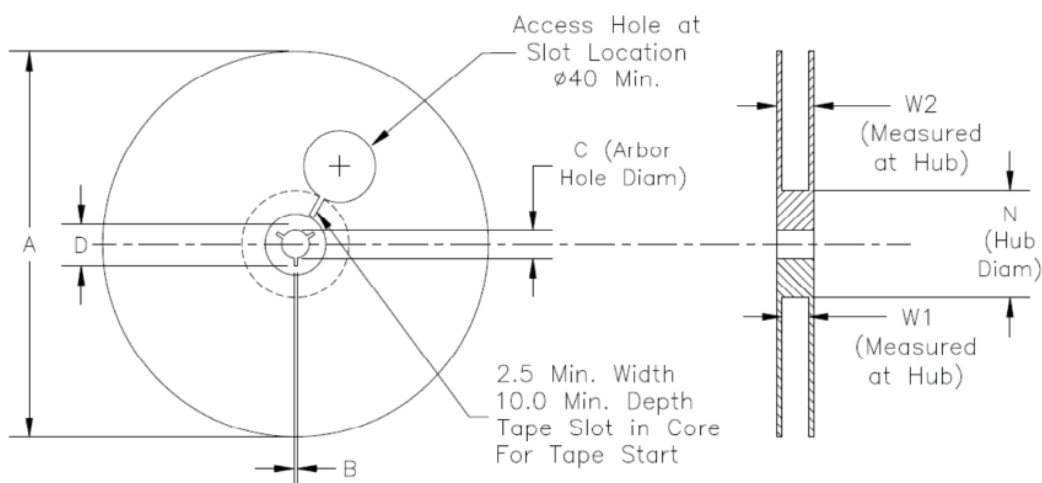

Unit: mm

| Tape Size | A max. | B min. | C | D min. | N | W1 | W2 max. |
|-----------|--------|--------|---------------|--------|---------|-------------|---------|
| 8mm | 180 | 1.5 | 13.0+0.6/-0.2 | 20.2 | 60±0.5 | 8.4+1.5/-0 | 14.4 |
| 12mm | 180 | 1.5 | 13.0±0.2 | 20.2 | 60±0.5 | 12.4+2.0/-0 | 18.4 |
| | 330 | 1.5 | 13.0±0.2 | 20.2 | 100±0.5 | 12.4+2.0/-0 | 18.4 |
| 16mm | 180 | 1.5 | 13.0±0.2 | 20.2 | 60±0.5 | 16.4+2.0/-0 | 22.4 |
| | 330 | 1.5 | 13.0±0.2 | 20.2 | 100±0.5 | 16.4+2.0/-0 | 22.4 |

| Device Size | "T" (1k/reel) | | "T3" (3k/reel) | |
|-------------|---------------|---------|----------------|----------|
| 2016 | 8mm Tape | 7" Reel | 8mm Tape | 7" Reel |
| 2520 | 8mm Tape | 7" Reel | 8mm Tape | 7" Reel |
| 3225 | 8mm Tape | 7" Reel | 8mm Tape | 7" Reel |
| 5032 | 12mm Tape | 7" Reel | 12mm Tape | 13" Reel |
| 7050 | 16mm Tape | 7" Reel | 16mm Tape | 13" Reel |

ATTENTION: Abracon Corporation's products are COTS – Commercial-Off-The-Shelf products; suitable for Commercial, Industrial and, where designated, Automotive Applications. Abracon's products are not specifically designed for Military, Aviation, Aerospace, Life-dependant Medical applications or any application requiring high reliability where component failure could result in loss of life and/or property. For applications requiring high reliability and/or presenting an extreme operating environment, written consent and authorization from Abracon Corporation is required. Please contact Abracon Corporation for more information.

ABRACON IS
ISO9001:2008
CERTIFIED



5101 Hidden Creek Lane Spicewood TX 78669
Phone: 512-371-6159 | Fax: 512-351-8858
For terms and conditions of sales please visit:
www.abracon.com

Revised: 06.17.2016



Компания «ЭлектроПласт» предлагает заключение долгосрочных отношений при поставках импортных электронных компонентов на взаимовыгодных условиях!

Наши преимущества:

- Оперативные поставки широкого спектра электронных компонентов отечественного и импортного производства напрямую от производителей и с крупнейших мировых складов;
- Поставка более 17-ти миллионов наименований электронных компонентов;
- Поставка сложных, дефицитных, либо снятых с производства позиций;
- Оперативные сроки поставки под заказ (от 5 рабочих дней);
- Экспресс доставка в любую точку России;
- Техническая поддержка проекта, помощь в подборе аналогов, поставка прототипов;
- Система менеджмента качества сертифицирована по Международному стандарту ISO 9001;
- Лицензия ФСБ на осуществление работ с использованием сведений, составляющих государственную тайну;
- Поставка специализированных компонентов (Xilinx, Altera, Analog Devices, Intersil, Interpoint, Microsemi, Aeroflex, Peregrine, Syfer, Eurofarad, Texas Instrument, Miteq, Cobham, E2V, MA-COM, Hittite, Mini-Circuits, General Dynamics и др.);

Помимо этого, одним из направлений компании «ЭлектроПласт» является направление «Источники питания». Мы предлагаем Вам помощь Конструкторского отдела:

- Подбор оптимального решения, техническое обоснование при выборе компонента;
- Подбор аналогов;
- Консультации по применению компонента;
- Поставка образцов и прототипов;
- Техническая поддержка проекта;
- Защита от снятия компонента с производства.



Как с нами связаться

Телефон: 8 (812) 309 58 32 (многоканальный)

Факс: 8 (812) 320-02-42

Электронная почта: org@eplast1.ru

Адрес: 198099, г. Санкт-Петербург, ул. Калинина, дом 2, корпус 4, литера А.