

## Optocoupler, Photodarlington Output, (Single, Dual, Quad Channel)

Single Channel

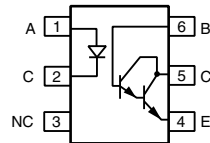

Dual Channel

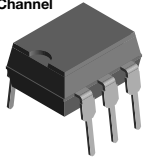
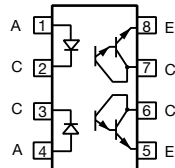
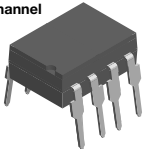

Quad Channel

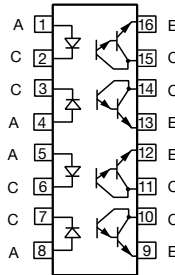
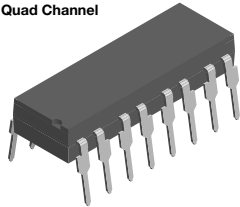

SMD

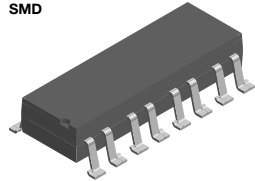

### FEATURES

- 125 mA load current rating
- Fast rise time, 10  $\mu$ s
- Fast fall time, 35  $\mu$ s
- Single, dual and quad channel
- Solid state reliability
- Standard DIP packages
- Material categorization: for definitions of compliance please see [www.vishay.com/doc?99912](http://www.vishay.com/doc?99912)



RoHS COMPLIANT

### AGENCY APPROVALS

- UL1577, file no. E52744 system code H, double protection
- cUL tested to CSA 22.2 bulletin 5A
- DIN EN 60747-5-2 (VDE 0884) / DIN EN 60747-5-5 pending available with option 1
- BSI IEC 60950; IEC 60065
- FIMKO

### DESCRIPTION

The IL30 single, ILD55 dual, and ILQ30, ILQ31, ILQ55 quad are optically coupled isolators with gallium arsenide infrared emitters and silicon photodarlington sensors. Switching can be achieved while maintaining a high degree of isolation between driving and load circuits, with no crosstalk between channels. These optocouplers can be used to replace reed and mercury relays with advantages of long life, high speed switching and elimination of magnetic fields.

The ILD55 is designed to reduce board space requirements in high density applications.

### ORDERING INFORMATION

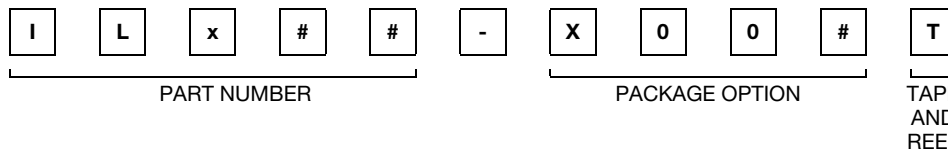

x = D (Dual) or Q (Quad)

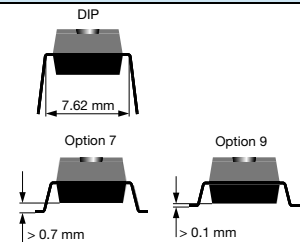

AGENCY CERTIFIED/PACKAGE	SINGLE CHANNEL	DUAL CHANNEL	QUAD CHANNEL	
	CTR			
<b>UL, cUL, BSI, FIMKO</b>	<b>≥ 100</b>	<b>≥ 100</b>	<b>≥ 100</b>	<b>≥ 200</b>
DIP-6	IL30	-	-	-
DIP-8	-	ILD55	-	-
SMD-8, option 7	-	ILD55-X007	-	-
SMD-8, option 9	-	ILD55-X009T <sup>(1)</sup>	-	-
DIP-16	-	-	ILQ30, ILQ55	ILQ31
SMD-16, option 7	-	-	ILQ55-X007	-
SMD-16, option 9	-	-	ILQ30-X009, ILQ55-X009T <sup>(1)</sup>	-
<b>VDE, UL, cUL, BSI, FIMKO</b>	<b>≥ 100</b>	<b>≥ 100</b>	<b>≥ 100</b>	<b>≥ 200</b>
DIP-16	-	-	ILQ30-X001	-

#### Notes

- Additional options may be possible, please contact sales office.
- <sup>(1)</sup> Also available in tubes, do not put "T" on the end.



ABSOLUTE MAXIMUM RATINGS (T <sub>amb</sub> = 25 °C, unless otherwise specified)					
PARAMETER	TEST CONDITION	PART	SYMBOL	VALUE	UNIT
<b>INPUT</b>					
Peak reverse voltage			V <sub>RM</sub>	3	V
Forward continuous current			I <sub>F</sub>	60	mA
Power dissipation			P <sub>diss</sub>	100	mW
Derate linearly from 25 °C				1.33	mW/°C
<b>OUTPUT</b>					
Collector emitter breakdown voltage		IL30	BV <sub>CEO</sub>	30	V
		ILQ30	BV <sub>CEO</sub>	30	V
		ILD55	BV <sub>CEO</sub>	55	V
		ILQ55	BV <sub>CEO</sub>	55	V
Collector (load) current			I <sub>C</sub>	125	mA
Power dissipation			P <sub>diss</sub>	150	mW
Derate linearly from 25 °C				2	mW/°C
<b>COUPLER</b>					
Total package power dissipation		IL30	P <sub>tot</sub>	250	mW
		ILD55	P <sub>tot</sub>	400	mW
		ILQ30	P <sub>tot</sub>	500	mW
		ILQ31	P <sub>tot</sub>	500	mW
		ILQ55	P <sub>tot</sub>	500	mW
Derate linearly from 25 °C		IL30		3.3	mW/°C
		ILD55		3.3	mW/°C
		ILQ30		6.67	mW/°C
		ILQ31		6.67	mW/°C
		ILQ55		6.67	mW/°C
Isolation test voltage			V <sub>ISO</sub>	5300	V <sub>RMS</sub>
Creepage distance				≥ 7	mm
Clearance distance				≥ 7	mm
Comparative tracking index			CTI	175	
Storage temperature			T <sub>stg</sub>	-55 to +125	°C
<b>COUPLER</b>					
Operating temperature			T <sub>amb</sub>	-55 to +100	°C
Lead soldering time at 260 °C				10	s

**Note**

- Stresses in excess of the absolute maximum ratings can cause permanent damage to the device. Functional operation of the device is not implied at these or any other conditions in excess of those given in the operational sections of this document. Exposure to absolute maximum ratings for extended periods of the time can adversely affect reliability.

ELECTRICAL CHARACTERISTICS (T <sub>amb</sub> = 25 °C, unless otherwise specified)						
PARAMETER	TEST CONDITION	SYMBOL	MIN.	TYP.	MAX.	UNIT
<b>INPUT</b>						
Forward voltage	I <sub>F</sub> = 20 mA	V <sub>F</sub>		1.25	1.5	V
Reverse current	V <sub>R</sub> = 3 V	I <sub>R</sub>		0.1	10	μA
Capacitance	V <sub>R</sub> = 0 V	C <sub>O</sub>		25		pF
<b>OUTPUT</b>						
Collector emitter breakdown voltage	I <sub>C</sub> = 100 μA	BV <sub>CEO</sub>	30/55			V
Collector emitter leakage current	V <sub>CE</sub> = 10 V, I <sub>F</sub> = 0 A	I <sub>CEO</sub>		1	100	nA
Collector emitter capacitance	V <sub>CE</sub> = 10 V, f = 1 MHz	C <sub>CE</sub>		3.4		pF
<b>COUPLER</b>						
Collector emitter saturation voltage	I <sub>C</sub> = 50 mA, I <sub>F</sub> = 50 mA	V <sub>CEsat</sub>		0.9	1	V
Isolation test voltage			5300			V <sub>RMS</sub>
Isolation resistance		R <sub>IO</sub>		10 <sup>12</sup>		Ω
Capacitance (input to output)		C <sub>IO</sub>		0.5		pF

**Note**

- Minimum and maximum values are testing requirements. Typical values are characteristics of the device and are the result of engineering evaluation. Typical values are for information only and are not part of the testing requirements.



CURRENT TRANSFER RATIO ( $T_{amb} = 25\text{ }^{\circ}\text{C}$ , unless otherwise specified)							
PARAMETER	TEST CONDITION	PART	SYMBOL	MIN.	TYP.	MAX.	UNIT
Current transfer ratio	$I_F = 10\text{ mA}$ , $V_{CE} = 5\text{ V}$	IL30	CTR	100	400		%
		ILD55	CTR	100	400		%
		ILQ30	CTR	100	400		%
		ILQ55	CTR	100	400		%
		ILQ31	CTR	200	400		%

SWITCHING CHARACTERISTICS ( $T_{amb} = 25\text{ }^{\circ}\text{C}$ , unless otherwise specified)							
PARAMETER	TEST CONDITION	SYMBOL	MIN.	TYP.	MAX.	UNIT	
Rise time	$V_{CC} = 13.5\text{ V}$ , $I_F = 50\text{ mA}$ , $R_L = 100\text{ }\Omega$	$t_r$		10		$\mu\text{s}$	
Fall time	$V_{CC} = 13.5\text{ V}$ , $I_F = 50\text{ mA}$ , $R_L = 100\text{ }\Omega$	$t_f$		35		$\mu\text{s}$	

**TYPICAL CHARACTERISTICS** ( $T_{amb} = 25\text{ }^{\circ}\text{C}$ , unless otherwise specified)

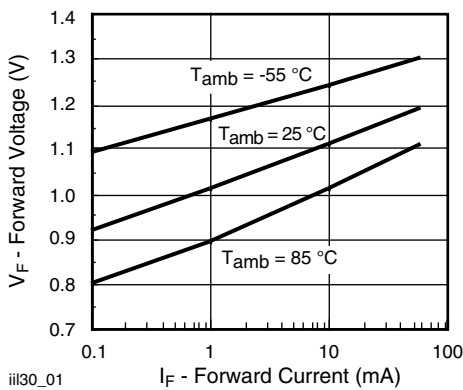

Fig. 1 - Forward Voltage vs. Forward Current

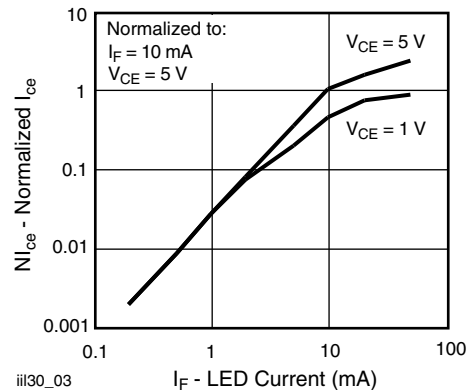

Fig. 3 - Normalized Non-Saturated and Saturated Collector Emitter Current vs. LED Current

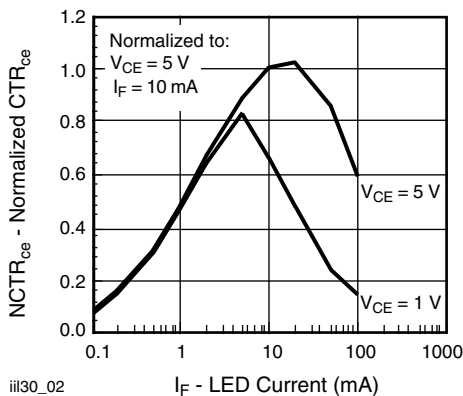

Fig. 2 - Normalized Non-Saturated and Saturated  $CTR_{ce}$  vs. LED Current

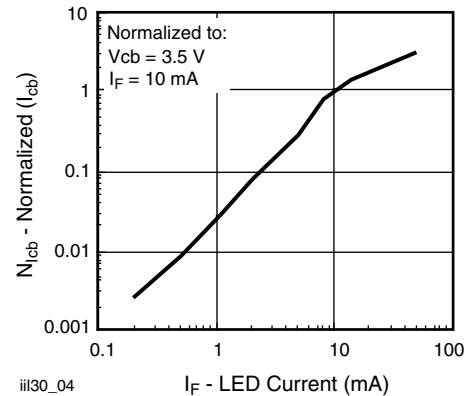
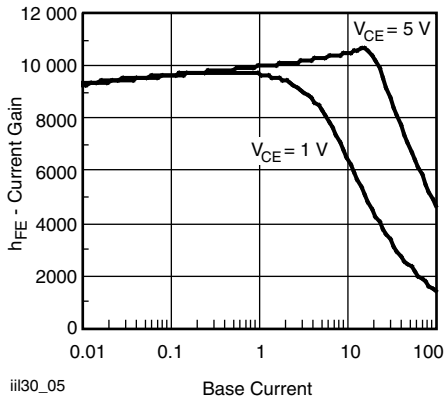
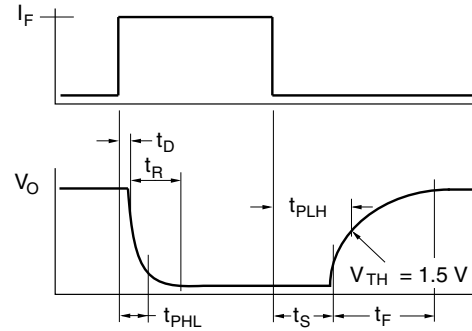

Fig. 4 - Normalized Collector Base Photocurrent vs. LED Current



iii30\_05

Fig. 5 -  $h_{FE}$  Current Gain vs. Base Current



iii30\_08

Fig. 8 - Switching Waveform

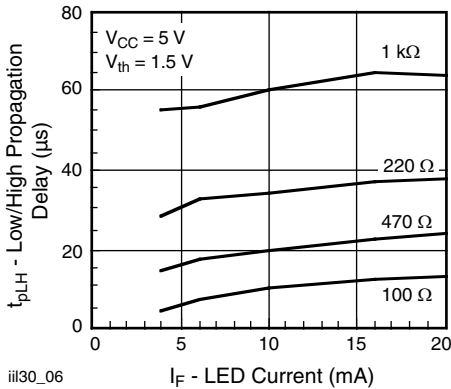

iii30\_06

Fig. 6 - Low to High Propagation Delay vs. Collector Load Resistance and LED Current

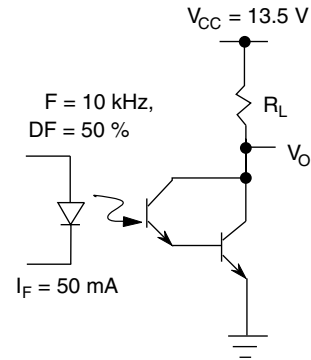

iii30\_09

Fig. 9 - Switching Schematic

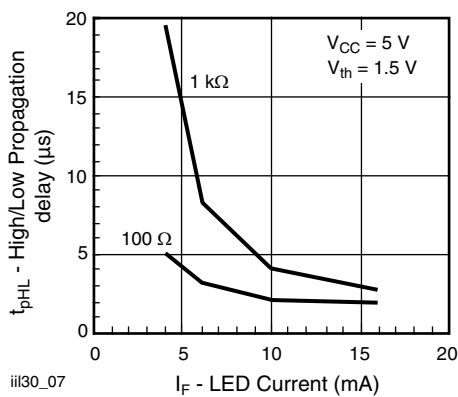

iii30\_07

Fig. 7 - High to Low Propagation Delay vs. Collector Load Resistance and LED Current



**PACKAGE DIMENSIONS** in millimeters

**DIP-6**



**DIP-8**





DIP-16

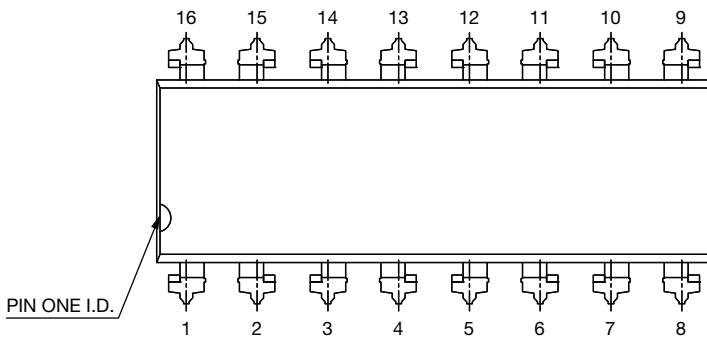
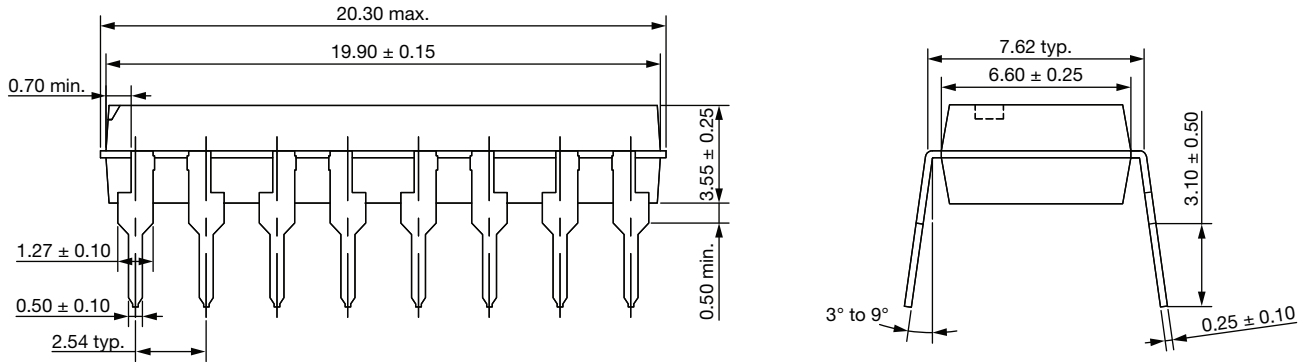

SMD-6, Option 7

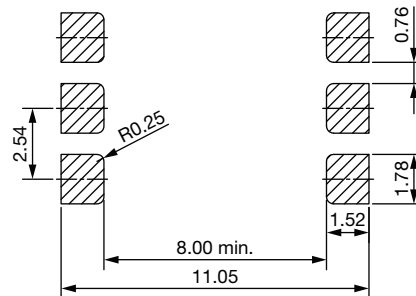
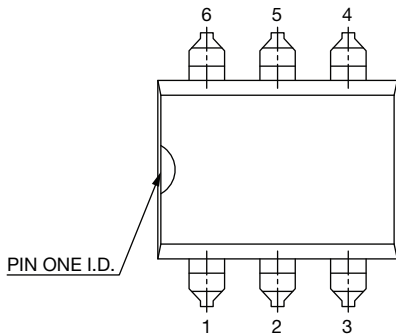
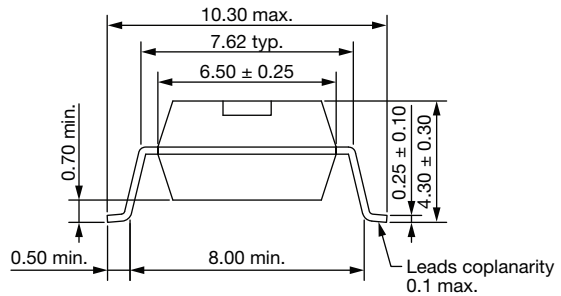
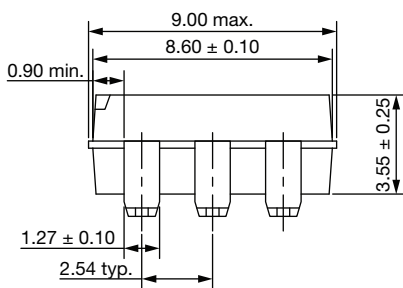



SMD-6, Option 9



SMD-8, Option 7

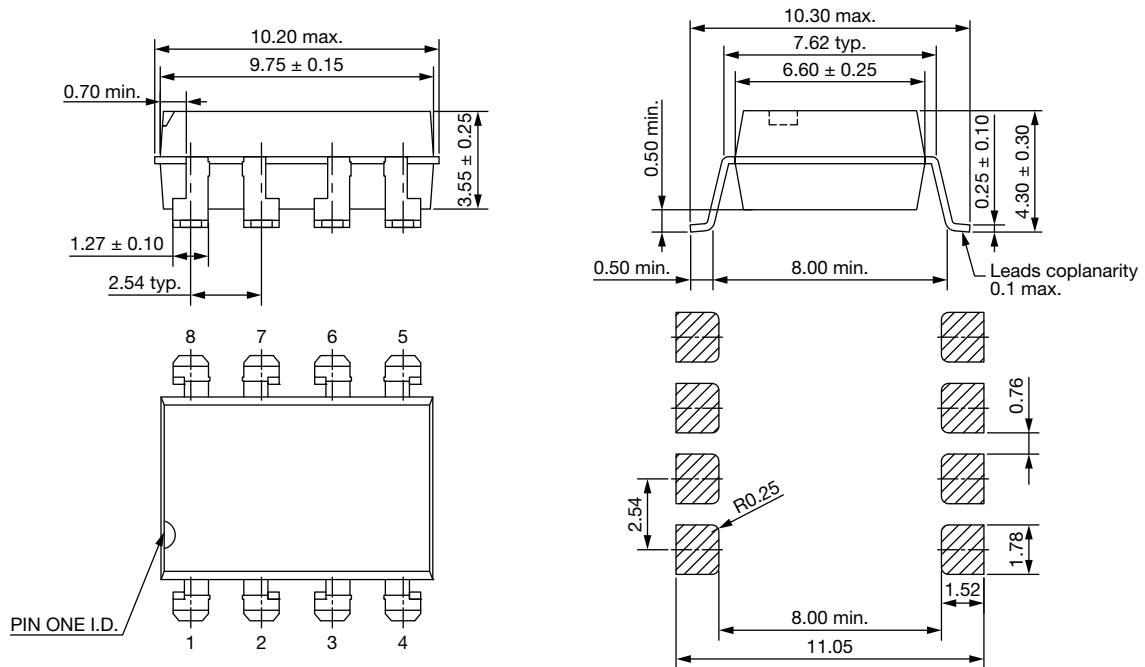



SMD-8, Option 9

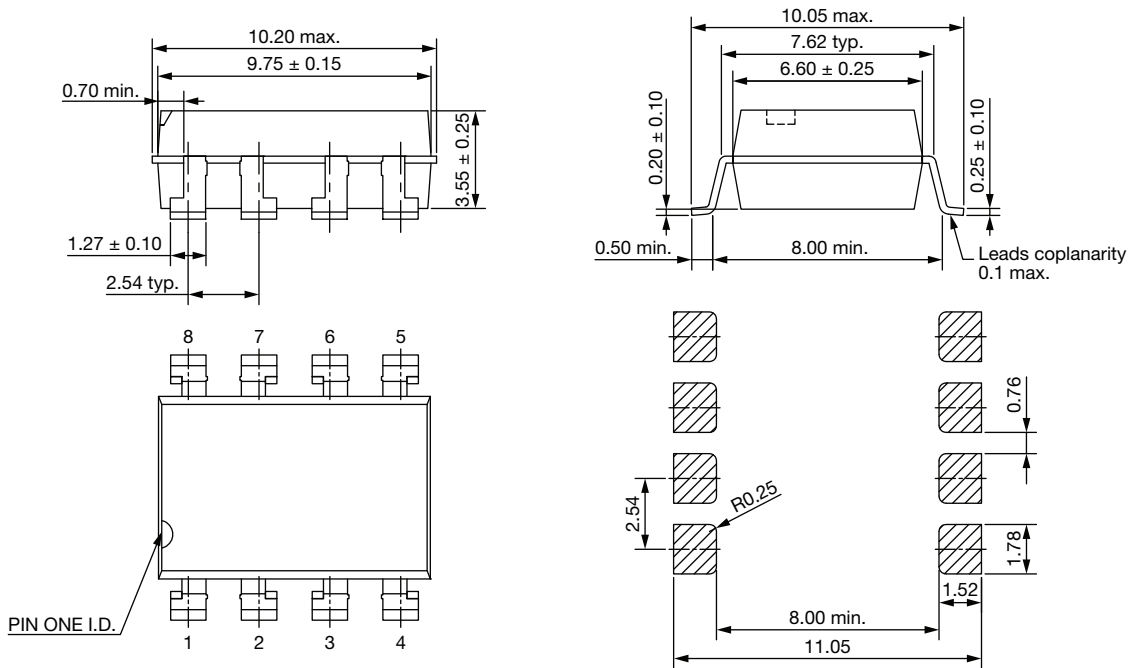

SMD-16, Option 7

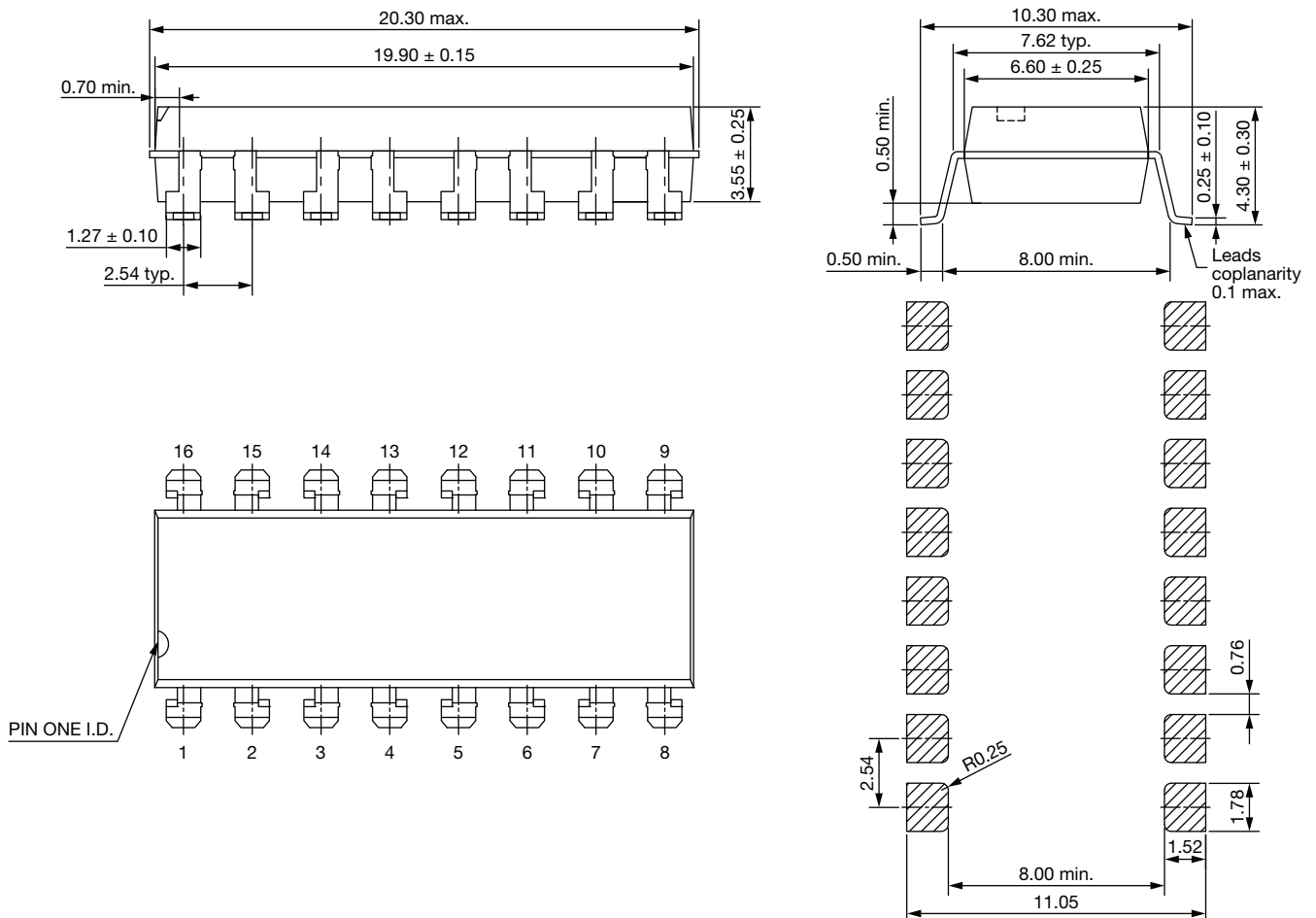





### SMD-16, Option 9

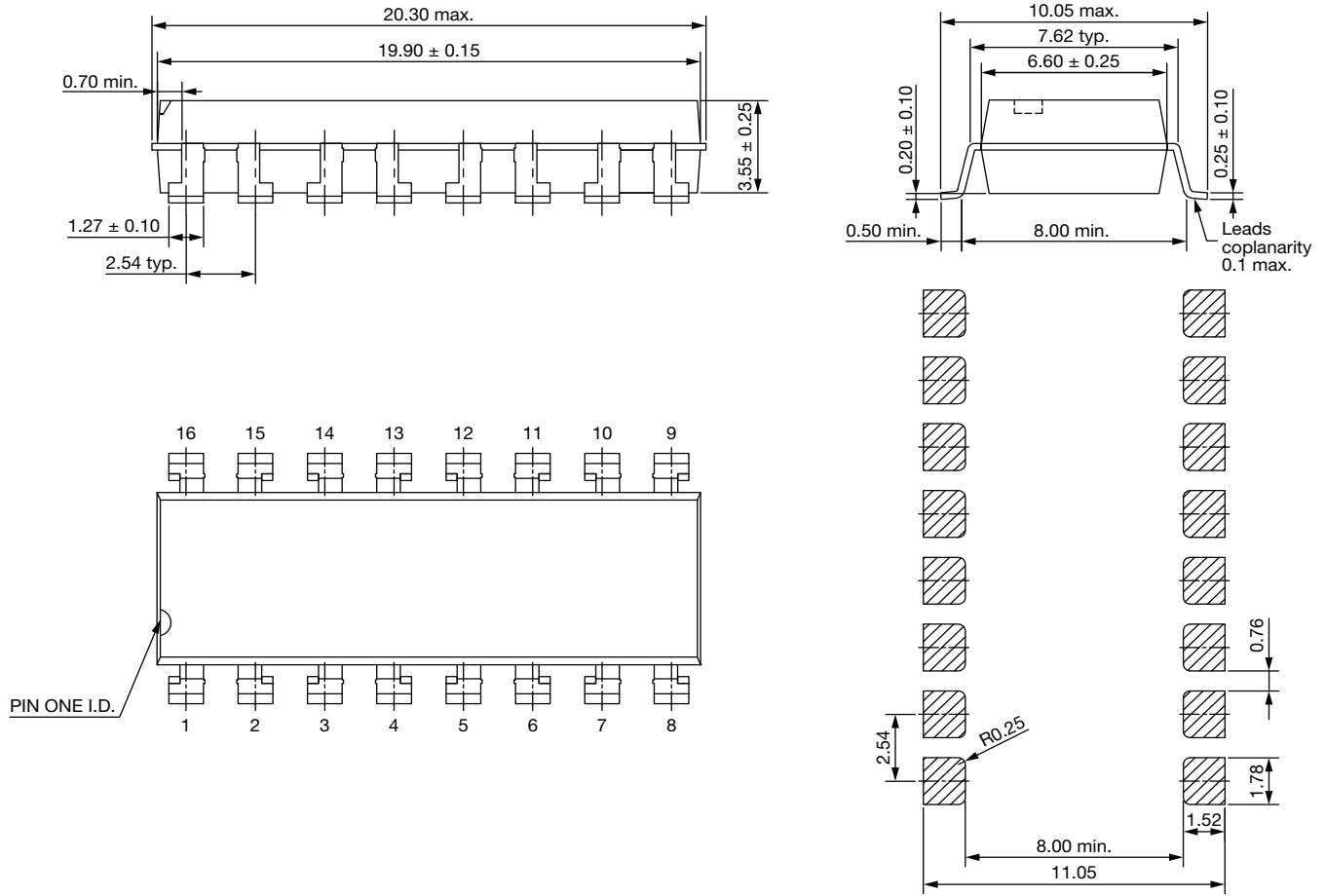

### PACKAGE MARKING (Example)

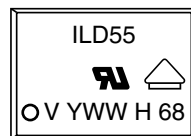

### Notes

- Only option 1 and 7 reflected in the package marking
- The VDE logo is only marked on option 1 parts
- Tape and reel suffix (T) is not part of the package marking



## Disclaimer

ALL PRODUCT, PRODUCT SPECIFICATIONS AND DATA ARE SUBJECT TO CHANGE WITHOUT NOTICE TO IMPROVE RELIABILITY, FUNCTION OR DESIGN OR OTHERWISE.

Vishay Intertechnology, Inc., its affiliates, agents, and employees, and all persons acting on its or their behalf (collectively, "Vishay"), disclaim any and all liability for any errors, inaccuracies or incompleteness contained in any datasheet or in any other disclosure relating to any product.

Vishay makes no warranty, representation or guarantee regarding the suitability of the products for any particular purpose or the continuing production of any product. To the maximum extent permitted by applicable law, Vishay disclaims (i) any and all liability arising out of the application or use of any product, (ii) any and all liability, including without limitation special, consequential or incidental damages, and (iii) any and all implied warranties, including warranties of fitness for particular purpose, non-infringement and merchantability.

Statements regarding the suitability of products for certain types of applications are based on Vishay's knowledge of typical requirements that are often placed on Vishay products in generic applications. Such statements are not binding statements about the suitability of products for a particular application. It is the customer's responsibility to validate that a particular product with the properties described in the product specification is suitable for use in a particular application. Parameters provided in datasheets and/or specifications may vary in different applications and performance may vary over time. All operating parameters, including typical parameters, must be validated for each customer application by the customer's technical experts. Product specifications do not expand or otherwise modify Vishay's terms and conditions of purchase, including but not limited to the warranty expressed therein.

Except as expressly indicated in writing, Vishay products are not designed for use in medical, life-saving, or life-sustaining applications or for any other application in which the failure of the Vishay product could result in personal injury or death. Customers using or selling Vishay products not expressly indicated for use in such applications do so at their own risk. Please contact authorized Vishay personnel to obtain written terms and conditions regarding products designed for such applications.

No license, express or implied, by estoppel or otherwise, to any intellectual property rights is granted by this document or by any conduct of Vishay. Product names and markings noted herein may be trademarks of their respective owners.

## Material Category Policy

**Vishay Intertechnology, Inc. hereby certifies that all its products that are identified as RoHS-Compliant fulfill the definitions and restrictions defined under Directive 2011/65/EU of The European Parliament and of the Council of June 8, 2011 on the restriction of the use of certain hazardous substances in electrical and electronic equipment (EEE) - recast, unless otherwise specified as non-compliant.**

**Please note that some Vishay documentation may still make reference to RoHS Directive 2002/95/EC. We confirm that all the products identified as being compliant to Directive 2002/95/EC conform to Directive 2011/65/EU.**

**Vishay Intertechnology, Inc. hereby certifies that all its products that are identified as Halogen-Free follow Halogen-Free requirements as per JEDEC JS709A standards. Please note that some Vishay documentation may still make reference to the IEC 61249-2-21 definition. We confirm that all the products identified as being compliant to IEC 61249-2-21 conform to JEDEC JS709A standards.**



Компания «ЭлектроПласт» предлагает заключение долгосрочных отношений при поставках импортных электронных компонентов на взаимовыгодных условиях!

Наши преимущества:

- Оперативные поставки широкого спектра электронных компонентов отечественного и импортного производства напрямую от производителей и с крупнейших мировых складов;
- Поставка более 17-ти миллионов наименований электронных компонентов;
- Поставка сложных, дефицитных, либо снятых с производства позиций;
- Оперативные сроки поставки под заказ (от 5 рабочих дней);
- Экспресс доставка в любую точку России;
- Техническая поддержка проекта, помощь в подборе аналогов, поставка прототипов;
- Система менеджмента качества сертифицирована по Международному стандарту ISO 9001;
- Лицензия ФСБ на осуществление работ с использованием сведений, составляющих государственную тайну;
- Поставка специализированных компонентов (Xilinx, Altera, Analog Devices, Intersil, Interpoint, Microsemi, Aeroflex, Peregrine, Syfer, Eurofarad, Texas Instrument, Miteq, Cobham, E2V, MA-COM, Hittite, Mini-Circuits, General Dynamics и др.);

Помимо этого, одним из направлений компании «ЭлектроПласт» является направление «Источники питания». Мы предлагаем Вам помощь Конструкторского отдела:

- Подбор оптимального решения, техническое обоснование при выборе компонента;
- Подбор аналогов;
- Консультации по применению компонента;
- Поставка образцов и прототипов;
- Техническая поддержка проекта;
- Защита от снятия компонента с производства.



#### Как с нами связаться

**Телефон:** 8 (812) 309 58 32 (многоканальный)

**Факс:** 8 (812) 320-02-42

**Электронная почта:** [org@eplast1.ru](mailto:org@eplast1.ru)

**Адрес:** 198099, г. Санкт-Петербург, ул. Калинина, дом 2, корпус 4, литера А.