

Precision, Micropower, Low-Dropout Voltage References

General Description

The MAX6190–MAX6195/MAX6198 precision, micropower, low-dropout voltage references offer high initial accuracy and very low temperature coefficient through a proprietary curvature-correction circuit and laser-trimmed precision thin-film resistors.

These series-mode bandgap references draw a maximum of only 35µA quiescent supply current, making them ideal for battery-powered instruments. They offer a supply current that is virtually immune to input voltage variations. Load-regulation specifications are guaranteed for source and sink currents up to 500µA. These devices are internally compensated, making them ideal for applications that require fast settling, and are stable with capacitive loads up to 2.2nF.

Selector Guide

PART	OUTPUT VOLTAGE (V)	INITIAL ACCURACY (mV)	TEMPERATURE COEFFICIENT (ppm/°C)
MAX6190A	1.250	±2	<5
MAX6190B	1.250	±4	<10
MAX6190C	1.250	±6	<25
MAX6191A	2.048	±2	<5
MAX6191B	2.048	±5	<10
MAX6191C	2.048	±10	<25
MAX6192A	2.500	±2	<5
MAX6192B	2.500	±5	<10
MAX6192C	2.500	±10	<25
MAX6193A	3.000	±2	<5
MAX6193B	3.000	±5	<10
MAX6193C	3.000	±10	<25
MAX6198A	4.096	±2	<5
MAX6198B	4.096	±5	<10
MAX6198C	4.096	±10	<25
MAX6194A	4.500	±2	<5
MAX6194B	4.500	±5	<10
MAX6194C	4.500	±10	<25
MAX6195A	5.000	±2	<5
MAX6195B	5.000	±5	<10
MAX6195C	5.000	±10	<25

Typical Operating Circuit appears at end of data sheet.

Features

- ◆ ±2mV (max) Initial Accuracy
- ◆ 5ppm/°C (max) Temperature Coefficient
- ◆ 35µA (max) Supply Current
- ◆ 100mV Dropout at 500µA Load Current
- ◆ 0.12µV/µA Load Regulation
- ◆ 8µV/V Line Regulation

Applications

Hand-Held Instruments
 Analog-to-Digital and Digital-to-Analog Converters
 Industrial Process Control
 Precision 3V/5V Systems
 Hard-Disk Drives

Ordering Information

PART	TEMP RANGE	PIN-PACKAGE
MAX6190AESA+	-40°C to +85°C	8 SO
MAX6190BESA+	-40°C to +85°C	8 SO
MAX6190CESA+	-40°C to +85°C	8 SO
MAX6191AESA+	-40°C to +85°C	8 SO
MAX6191BESA+	-40°C to +85°C	8 SO
MAX6191CESA+	-40°C to +85°C	8 SO
MAX6192AESA+	-40°C to +85°C	8 SO
MAX6192BESA+	-40°C to +85°C	8 SO
MAX6192CESA+	-40°C to +85°C	8 SO

Ordering Information continued at end of data sheet.

+Denotes a lead(Pb)-free /RoHS-compliant package.

Pin Configuration

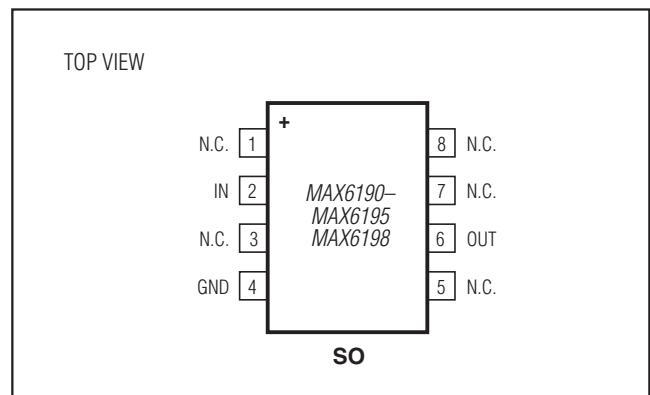

MAX6190–MAX6195/MAX6198

Precision, Micropower, Low-Dropout Voltage References

ABSOLUTE MAXIMUM RATINGS

Voltages Referenced to GND

IN-0.3V to +13.5V

OUT-0.3V to ($V_{IN} + 0.3V$)

Output Short Circuit to GND or IN ($V_{IN} < 6V$)Continuous

Output Short Circuit to GND or IN ($V_{IN} \geq 6V$)60s

Continuous Power Dissipation ($T_A = +70^\circ C$)

8-Pin SO (derate 5.88mW/ $^\circ C$ above $+70^\circ C$).....471mW

Operating Temperature Range-40 $^\circ C$ to +85 $^\circ C$

Junction Temperature.....+150 $^\circ C$

Storage Temperature Range-65 $^\circ C$ to +150 $^\circ C$

Lead Temperature (soldering, 10s)+300 $^\circ C$

Soldering Temperature (reflow)+260 $^\circ C$

Stresses beyond those listed under "Absolute Maximum Ratings" may cause permanent damage to the device. These are stress ratings only, and functional operation of the device at these or any other conditions beyond those indicated in the operational sections of the specifications is not implied. Exposure to absolute maximum rating conditions for extended periods may affect device reliability.

ELECTRICAL CHARACTERISTICS—MAX6190

($V_{IN} = 5V$, $I_{OUT} = 0nA$, $T_A = T_{MIN}$ to T_{MAX} , unless otherwise noted. Typical values are at $T_A = +25^\circ C$.)

PARAMETER	SYMBOL	CONDITIONS	MIN	TYP	MAX	UNITS	
OUTPUT							
Output Voltage	V_{OUT}	$T_A = +25^\circ C$	MAX6190A	1.248	1.250	1.252	V
			MAX6190B	1.246	1.250	1.254	
			MAX6190C	1.244	1.250	1.256	
Output-Voltage Temperature Coefficient (Note 1)	TCV_{OUT}	MAX6190A		2	5	ppm/ $^\circ C$	
		MAX6190B		4	10		
		MAX6190C		8	25		
Line Regulation	$\frac{\Delta V_{OUT}}{\Delta V_{IN}}$	$2.5V \leq V_{IN} \leq 12.6V$		8	80	$\mu V/V$	
Load Regulation	$\frac{\Delta V_{OUT}}{\Delta I_{OUT}}$	Sourcing: $0 \leq I_{OUT} \leq 500\mu A$		0.12	0.5	$\mu V/\mu A$	
		Sinking: $-500\mu A \leq I_{OUT} \leq 0$		0.15	0.6		
Short-Circuit Current	I_{SC}	Short to GND		4		mA	
		Short to IN		4			
Temperature Hysteresis (Note 2)	$\frac{\Delta V_{OUT}}{\text{cycle}}$			75		ppm	
Long-Term Stability	$\frac{\Delta V_{OUT}}{\text{time}}$	1000hrs at $+25^\circ C$		50		ppm/1000hrs	
DYNAMIC							
Noise Voltage	e_{OUT}	0.1Hz to 10Hz		25		μV_{P-P}	
		10Hz to 10kHz		65		μV_{RMS}	
Ripple Rejection	V_{OUT}/V_{IN}	$V_{IN} = 5V \pm 100mV$, $f = 120Hz$		86		dB	
Turn-On Settling Time	t_R	$T_O 0.1\%$, $C_{OUT} = 50pF$		30		μs	
Capacitive-Load Stability Range	C_{OUT}	(Note 3)	0		2.2	nF	
INPUT							
Supply Voltage Range	V_{IN}	Guaranteed by line-regulation test	2.5		12.6	V	
Quiescent Supply Current	I_{IN}			27	35	μA	
Change in Supply Current	I_{IN}/V_{IN}	$2.5V \leq V_{IN} \leq 12.6V$		0.8	2	$\mu A/V$	

MAX6190–MAX6195/MAX6198

Precision, Micropower, Low-Dropout Voltage References

ELECTRICAL CHARACTERISTICS—MAX6191

($V_{IN} = 5V$, $I_{OUT} = 0nA$, $T_A = T_{MIN}$ to T_{MAX} , unless otherwise noted. Typical values are at $T_A = +25^\circ C$.)

PARAMETER	SYMBOL	CONDITIONS	MIN	TYP	MAX	UNITS	
OUTPUT							
Output Voltage	V_{OUT}	$T_A = +25^\circ C$	MAX6191A	2.046	2.048	2.050	V
			MAX6191B	2.043	2.048	2.053	
			MAX6191C	2.038	2.048	2.058	
Output-Voltage Temperature Coefficient (Note 1)	TCV_{OUT}	MAX6191A		2	5	ppm/ $^\circ C$	
		MAX6191B		4	10		
		MAX6191C		8	25		
Line Regulation	$\frac{\Delta V_{OUT}}{\Delta V_{IN}}$	$2.5V \leq V_{IN} \leq 12.6V$		10	100	$\mu V/V$	
Load Regulation	$\frac{\Delta V_{OUT}}{\Delta I_{OUT}}$	Sourcing: $0 \leq I_{OUT} \leq 500\mu A$		0.12	0.55	$\mu V/\mu A$	
		Sinking: $-500\mu A \leq I_{OUT} \leq 0$		0.18	0.70		
Short-Circuit Current	I_{SC}	Short to GND		4		mA	
		Short to IN		4			
Temperature Hysteresis (Note 2)	$\frac{\Delta V_{OUT}}{\text{cycle}}$			75		ppm	
Long-Term Stability	$\frac{\Delta V_{OUT}}{\text{time}}$	1000hrs at $+25^\circ C$		50		ppm/1000hrs	
DYNAMIC							
Noise Voltage	e_{OUT}	0.1Hz to 10Hz		40		μV_{P-P}	
		10Hz to 10kHz		105		μV_{RMS}	
Ripple Rejection	V_{OUT}/V_{IN}	$V_{IN} = 5V \pm 100mV$, $f = 120Hz$		84		dB	
Turn-On Settling Time	t_R	To 0.1%, $C_{OUT} = 50pF$		30		μs	
Capacitive-Load Stability Range	C_{OUT}	(Note 3)	0		2.2	nF	
INPUT							
Supply Voltage Range	V_{IN}	Guaranteed by line-regulation test	2.5		12.6	V	
Quiescent Supply Current	I_{IN}			27	35	μA	
Change in Supply Current	I_{IN}/V_{IN}	$2.5V \leq V_{IN} \leq 12.6V$		0.8	2	$\mu A/V$	

MAX6190–MAX6195/MAX6198

Precision, Micropower, Low-Dropout Voltage References

ELECTRICAL CHARACTERISTICS—MAX6192

($V_{IN} = 5V$, $I_{OUT} = 0nA$, $T_A = T_{MIN}$ to T_{MAX} , unless otherwise noted. Typical values are at $T_A = +25^\circ C$.)

PARAMETER	SYMBOL	CONDITIONS	MIN	TYP	MAX	UNITS	
OUTPUT							
Output Voltage	V_{OUT}	$T_A = +25^\circ C$	MAX6192A	2.498	2.500	2.502	V
			MAX6192B	2.495	2.500	2.505	
			MAX6192C	2.490	2.500	2.510	
Output-Voltage Temperature Coefficient (Note 1)	TCV_{OUT}	MAX6192A		2	5	ppm/ $^\circ C$	
		MAX6192B		4	10		
		MAX6192C		8	25		
Line Regulation	$\frac{\Delta V_{OUT}}{\Delta V_{IN}}$	$(V_{OUT} + 0.2V) \leq V_{IN} \leq 12.6V$		15	140	$\mu V/V$	
Load Regulation	$\frac{\Delta V_{OUT}}{\Delta I_{OUT}}$	Sourcing: $0 \leq I_{OUT} \leq 500\mu A$		0.14	0.60	$\mu V/\mu A$	
		Sinking: $-500\mu A \leq I_{OUT} \leq 0$		0.18	0.80		
Dropout Voltage (Note 4)	$V_{IN} - V_{OUT}$	$\Delta V_{OUT} \leq 0.2\%$, $I_{OUT} = 500\mu A$		100	200	mV	
Short-Circuit Current	I_{SC}	Short to GND		4		mA	
		Short to IN		4			
Temperature Hysteresis (Note 2)	$\frac{\Delta V_{OUT}}{\text{cycle}}$			75		ppm	
Long-Term Stability	$\frac{\Delta V_{OUT}}{\text{time}}$	1000hrs at $+25^\circ C$		50		ppm/1000hrs	
DYNAMIC							
Noise Voltage	e_{OUT}	0.1Hz to 10Hz		60		μV_{P-P}	
		10Hz to 10kHz		125		μV_{RMS}	
Ripple Rejection	V_{OUT}/V_{IN}	$V_{IN} = 5V \pm 100mV$, $f = 120Hz$		82		dB	
Turn-On Settling Time	t_R	To 0.1%, $C_{OUT} = 50pF$		85		μs	
Capacitive-Load Stability Range	C_{OUT}	(Note 3)	0		2.2	nF	
INPUT							
Supply Voltage Range	V_{IN}	Guaranteed by line-regulation test	$V_{OUT} + 0.2$		12.6	V	
Quiescent Supply Current	I_{IN}			27	35	μA	
Change in Supply Current	I_{IN}/V_{IN}	$(V_{OUT} + 0.2V) \leq V_{IN} \leq 12.6V$		0.8	2	$\mu A/V$	

MAX6190–MAX6195/MAX6198

Precision, Micropower, Low-Dropout Voltage References

ELECTRICAL CHARACTERISTICS—MAX6193

($V_{IN} = 5V$, $I_{OUT} = 0nA$, $T_A = T_{MIN}$ to T_{MAX} , unless otherwise noted. Typical values are at $T_A = +25^{\circ}C$.)

PARAMETER	SYMBOL	CONDITIONS	MIN	TYP	MAX	UNITS	
OUTPUT							
Output Voltage	V_{OUT}	$T_A = +25^{\circ}C$	MAX6193A	2.998	3.000	3.002	V
			MAX6193B	2.995	3.000	3.005	
			MAX6193C	2.990	3.000	3.010	
Output-Voltage Temperature Coefficient (Note 1)	TCV_{OUT}	MAX6193A		2	5	ppm/ $^{\circ}C$	
		MAX6193B		4	10		
		MAX6193C		8	25		
Line Regulation	$\frac{\Delta V_{OUT}}{\Delta V_{IN}}$	$2.5V \leq V_{IN} \leq 12.6V$		20	150	$\mu V/V$	
Load Regulation	$\frac{\Delta V_{OUT}}{\Delta I_{OUT}}$	Sourcing: $0 \leq I_{OUT} \leq 500\mu A$		0.14	0.60	$\mu V/\mu A$	
		Sinking: $-500\mu A \leq I_{OUT} \leq 0$		0.18	0.80		
Dropout Voltage (Note 4)	$V_{IN} - V_{OUT}$	$I_{OUT} = 500\mu A$		100	200	mV	
Short-Circuit Current	I_{SC}	Short to GND		4		mA	
		Short to IN		4			
Temperature Hysteresis (Note 2)	$\frac{\Delta V_{OUT}}{\text{cycle}}$			75		ppm	
Long-Term Stability	$\frac{\Delta V_{OUT}}{\text{time}}$	1000hrs at $+25^{\circ}C$		50		ppm/1000hrs	
DYNAMIC							
Noise Voltage	e_{OUT}	0.1Hz to 10Hz		75		μV_{P-P}	
		10Hz to 10kHz		150		μV_{RMS}	
Ripple Rejection	V_{OUT}/V_{IN}	$V_{IN} = 5V \pm 100mV$, $f = 120Hz$		80		dB	
Turn-On Settling Time	t_R	To 0.1%, $C_{OUT} = 50pF$		100		μs	
Capacitive-Load Stability Range	C_{OUT}	(Note 3)	0		2.2	nF	
INPUT							
Supply Voltage Range	V_{IN}	Guaranteed by line-regulation test	$V_{OUT} + 0.2$		12.6	V	
Quiescent Supply Current	I_{IN}			27	35	μA	
Change in Supply Current	I_{IN}/V_{IN}	$(V_{OUT} + 0.2V) \leq V_{IN} \leq 12.6V$		0.8	2	$\mu A/V$	

MAX6190–MAX6195/MAX6198

Precision, Micropower, Low-Dropout Voltage References

ELECTRICAL CHARACTERISTICS—MAX6194

($V_{IN} = 5V$, $I_{OUT} = 0nA$, $T_A = T_{MIN}$ to T_{MAX} , unless otherwise noted. Typical values are at $T_A = +25^\circ C$.)

PARAMETER	SYMBOL	CONDITIONS	MIN	TYP	MAX	UNITS	
INPUT							
Output Voltage	V_{OUT}	$T_A = +25^\circ C$	MAX6194A	4.498	4.500	4.502	V
			MAX6194B	4.495	4.500	4.505	
			MAX6194C	4.490	4.500	4.510	
Output-Voltage Temperature Coefficient (Note 1)	TCV_{OUT}	MAX6194A		2	5	ppm/ $^\circ C$	
		MAX6194B		4	10		
		MAX6194C		8	25		
Line Regulation	$\frac{\Delta V_{OUT}}{\Delta V_{IN}}$	$(V_{OUT} + 0.2V) \leq V_{IN} \leq 12.6V$		25	160	$\mu V/V$	
Load Regulation	$\frac{\Delta V_{OUT}}{\Delta I_{OUT}}$	Sourcing: $0 \leq I_{OUT} \leq 500\mu A$		0.16	0.80	$\mu V/\mu A$	
		Sinking: $-500\mu A \leq I_{OUT} \leq 0$		0.22	1.00		
Dropout Voltage (Note 4)	$V_{IN} - V_{OUT}$	$\Delta V_{OUT} \leq 0.2\%$, $I_{OUT} = 500\mu A$		100	200	mV	
Short-Circuit Current	I_{SC}	Short to GND		4		mA	
		Short to IN		4			
Temperature Hysteresis (Note 2)	$\frac{\Delta V_{OUT}}{\text{cycle}}$			75		ppm	
Long-Term Stability	$\frac{\Delta V_{OUT}}{\text{time}}$	1000hrs at $+25^\circ C$		50		ppm/1000hrs	
DYNAMIC							
Noise Voltage	e_{OUT}	0.1Hz to 10Hz		110		μV_{P-P}	
		10Hz to 10kHz		215		μV_{RMS}	
Ripple Rejection	V_{OUT}/V_{IN}	$V_{IN} = 5V \pm 100mV$, $f = 120Hz$		76		dB	
Turn-On Settling Time	t_R	To 0.1%, $C_{OUT} = 50pF$		180		μs	
Capacitive-Load Stability Range	C_{OUT}	(Note 3)	0		2.2	nF	
OUTPUT							
Supply Voltage Range	V_{IN}	Guaranteed by line-regulation test	$V_{OUT} + 0.2$		12.6	V	
Quiescent Supply Current	I_{IN}			27	35	μA	
Change in Supply Current	I_{IN}/V_{IN}	$(V_{OUT} + 0.2V) \leq V_{IN} \leq 12.6V$		0.8	2	$\mu A/V$	

MAX6190–MAX6195/MAX6198

Precision, Micropower, Low-Dropout Voltage References

ELECTRICAL CHARACTERISTICS—MAX6195

($V_{IN} = 5.5V$, $I_{OUT} = 0nA$, $T_A = T_{MIN}$ to T_{MAX} , unless otherwise noted. Typical values are at $T_A = +25^{\circ}C$.)

PARAMETER	SYMBOL	CONDITIONS	MIN	TYP	MAX	UNITS	
INPUT							
Output Voltage	V_{OUT}	$T_A = +25^{\circ}C$	MAX6195A	4.998	5.000	5.002	V
			MAX6195B	4.995	5.000	5.005	
			MAX6195C	4.990	5.000	5.010	
Output-Voltage Temperature Coefficient (Note 1)	TCV_{OUT}	MAX6195A		2	5	ppm/ $^{\circ}C$	
		MAX6195B		4	10		
		MAX6195C		8	25		
Line Regulation	$\frac{\Delta V_{OUT}}{\Delta V_{IN}}$	$(V_{OUT} + 0.2V) \leq V_{IN} \leq 12.6V$		25	160	$\mu V/V$	
Load Regulation	$\frac{\Delta V_{OUT}}{\Delta I_{OUT}}$	Sourcing: $0 \leq I_{OUT} \leq 500\mu A$		0.17	0.85	$\mu V/\mu A$	
		Sinking: $-500\mu A \leq I_{OUT} \leq 0$		0.24	1.10		
Dropout Voltage (Note 4)	$V_{IN} - V_{OUT}$	$\Delta V_{OUT} \leq 0.2\%$, $I_{OUT} = 500\mu A$		100	200	mA	
Short-Circuit Current	I_{SC}	Short to GND		4		mA	
		Short to IN		4			
Temperature Hysteresis (Note 2)	$\frac{\Delta V_{OUT}}{\text{cycle}}$			75		ppm	
Long-Term Stability	$\frac{\Delta V_{OUT}}{\text{time}}$	1000hrs at $+25^{\circ}C$		50		ppm/1000hrs	
DYNAMIC							
Noise Voltage	e_{OUT}	0.1Hz to 10Hz		120		μV_{P-P}	
		10Hz to 10kHz		240		μV_{RMS}	
Ripple Rejection	V_{OUT}/V_{IN}	$V_{IN} = 5.5V \pm 100mV$, $f = 120Hz$		72		dB	
Turn-On Settling Time	t_R	To 0.1%, $C_{OUT} = 50pF$		220		μs	
Capacitive-Load Stability Range	C_{OUT}	(Note 3)	0		2.2	nF	
OUTPUT							
Supply Voltage Range	V_{IN}	Guaranteed by line-regulation test	$V_{OUT} + 0.2$		12.6	V	
Quiescent Supply Current	I_{IN}			27	35	μA	
Change in Supply Current	I_{IN}/V_{IN}	$(V_{OUT} + 0.2V) \leq V_{IN} \leq 12.6V$		0.8	2	$\mu A/V$	

MAX6190–MAX6195/MAX6198

Precision, Micropower, Low-Dropout Voltage References

ELECTRICAL CHARACTERISTICS—MAX6198

($V_{IN} = 5V$, $I_{OUT} = 0nA$, $T_A = T_{MIN}$ to T_{MAX} , unless otherwise noted. Typical values are at $T_A = +25^{\circ}C$.)

PARAMETER	SYMBOL	CONDITIONS	MIN	TYP	MAX	UNITS	
OUTPUT							
Output Voltage	V_{OUT}	$T_A = +25^{\circ}C$	MAX6198A	4.094	4.096	4.098	V
			MAX6198B	4.091	4.096	4.101	
			MAX6198C	4.086	4.096	4.106	
Output-Voltage Temperature Coefficient (Note 1)	TCV_{OUT}	MAX6198A		2	5	ppm/ $^{\circ}C$	
		MAX6198B		4	10		
		MAX6198C		8	25		
Line Regulation	$\frac{\Delta V_{OUT}}{\Delta V_{IN}}$	$(V_{OUT} + 0.2V) \leq V_{IN} \leq 12.6V$		25	160	$\mu V/V$	
Load Regulation	$\frac{\Delta V_{OUT}}{\Delta I_{OUT}}$	Sourcing: $0 \leq I_{OUT} \leq 500\mu A$		0.15	0.70	$\mu V/\mu A$	
		Sinking: $-500\mu A \leq I_{OUT} \leq 0$		0.20	0.90		
Dropout Voltage (Note 4)	$V_{IN} - V_{OUT}$	$\Delta V_{OUT} \leq 0.2\%$, $I_{OUT} = 500\mu A$		100	200	mV	
Short-Circuit Current	I_{SC}	Short to GND		4		mA	
		Short to IN		4			
Temperature Hysteresis (Note 2)	$\frac{\Delta V_{OUT}}{\text{cycle}}$			75		ppm	
Long-Term Stability	$\frac{\Delta V_{OUT}}{\text{time}}$	1000hrs at $+25^{\circ}C$		50		ppm/1000hrs	
DYNAMIC							
Noise Voltage	e_{OUT}	0.1Hz to 10Hz		100		μV_{P-P}	
		10Hz to 10kHz		200		μV_{RMS}	
Ripple Rejection	V_{OUT}/V_{IN}	$V_{IN} = 5V \pm 100mV$, $f = 120Hz$		77		dB	
Turn-On Settling Time	t_R	To 0.1%, $C_{OUT} = 50pF$		160		μs	
Capacitive-Load Stability Range	C_{OUT}	(Note 3)	0		2.2	nF	
INPUT							
Supply Voltage Range	V_{IN}	Guaranteed by line-regulation test	$V_{OUT} + 0.2$		12.6	V	
Quiescent Supply Current	I_{IN}			27	35	μA	
Change in Supply Current	I_{IN}/V_{IN}	$(V_{OUT} + 0.2V) \leq V_{IN} \leq 12.6V$		0.8	2	$\mu A/V$	

Note 1: Temperature Coefficient is measured by the "box" method; i.e., the maximum ΔV_{OUT} is divided by the maximum Δt .

Note 2: Thermal Hysteresis is defined as the change in $+25^{\circ}C$ output voltage before and after cycling the device from T_{MIN} to T_{MAX} .

Note 3: Not production tested. Guaranteed by design.

Note 4: Dropout voltage is the minimum input voltage at which V_{OUT} changes $\leq 0.2\%$ from V_{OUT} at $V_{IN} = 5.0V$ ($V_{IN} = 5.5V$ for MAX6195).

MAX6190–MAX6195/MAX6198

Precision, Micropower, Low-Dropout Voltage References

Typical Operating Characteristics

($V_{IN} = 5V$ for MAX6190/1/2/3/4/8, $V_{IN} = 5.5V$ for MAX6195; $I_{OUT} = 0nA$; $T_A = +25^\circ C$; unless otherwise noted.) (Note 5)

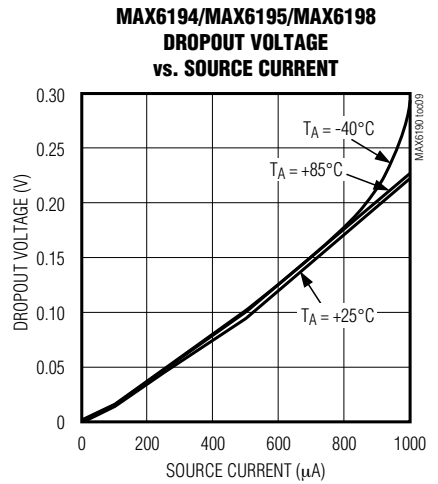
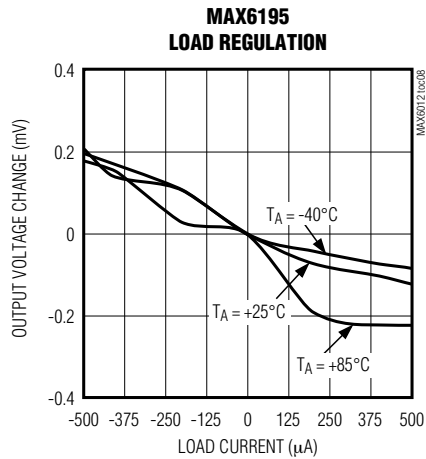
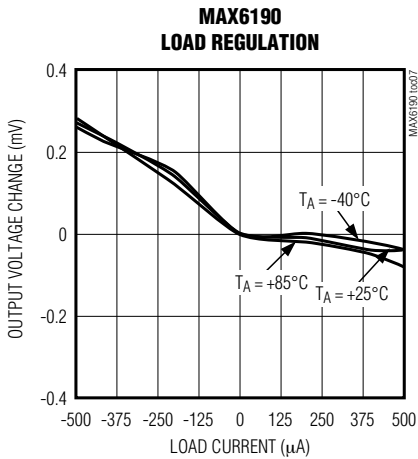
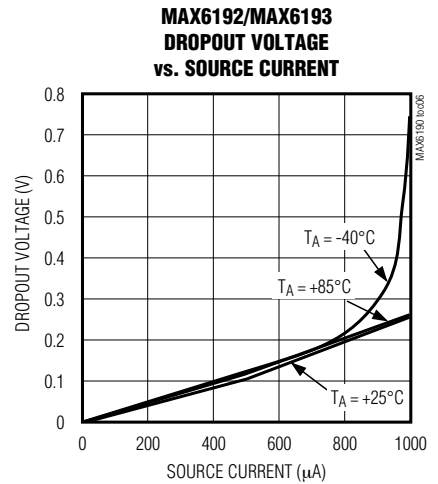
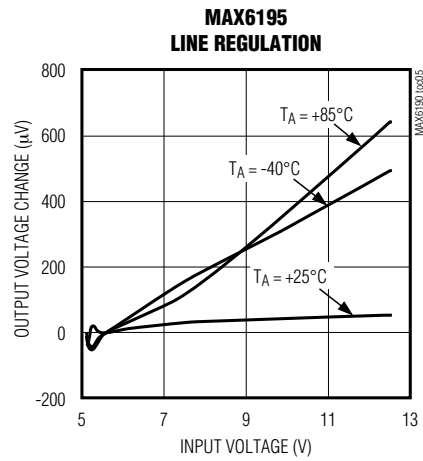
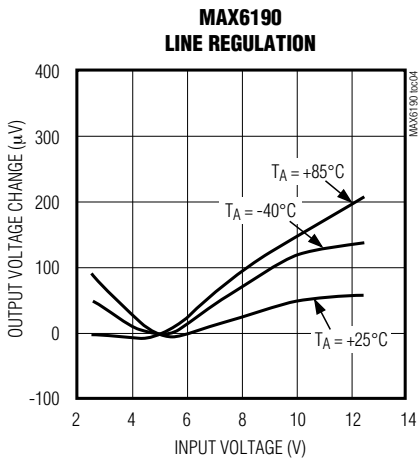
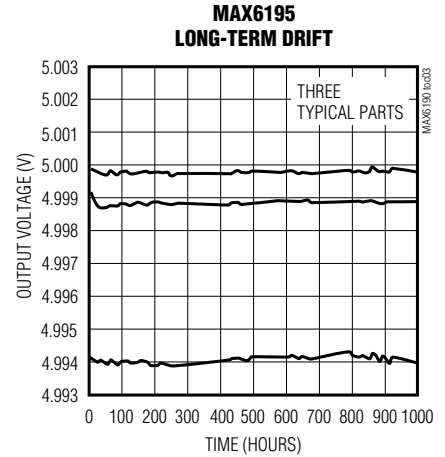
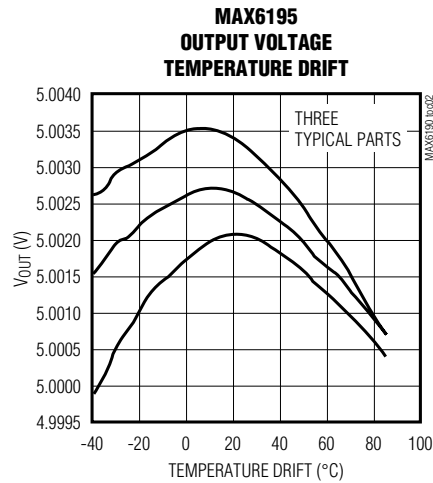
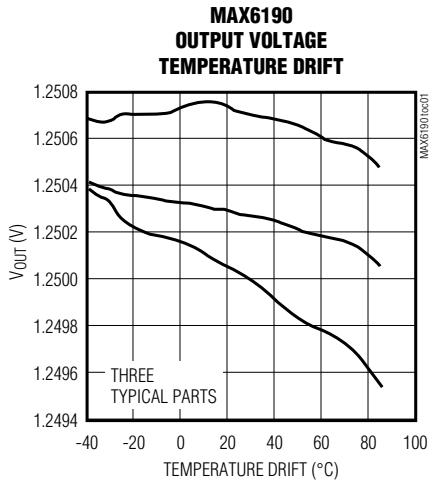

MAX6190–MAX6195/MAX6198

Precision, Micropower, Low-Dropout Voltage References

Typical Operating Characteristics (continued)

($V_{IN} = 5V$ for MAX6190/1/2/3/4/8, $V_{IN} = 5.5V$ for MAX6195; $I_{OUT} = 0nA$; $T_A = +25^\circ C$; unless otherwise noted.) (Note 5)

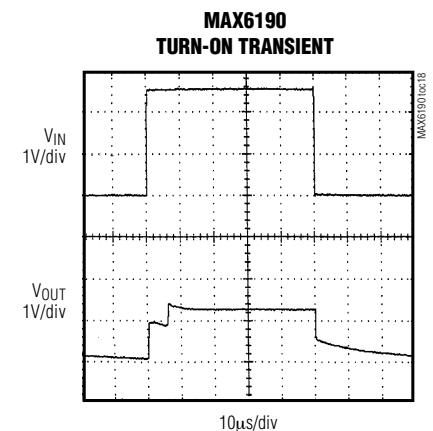
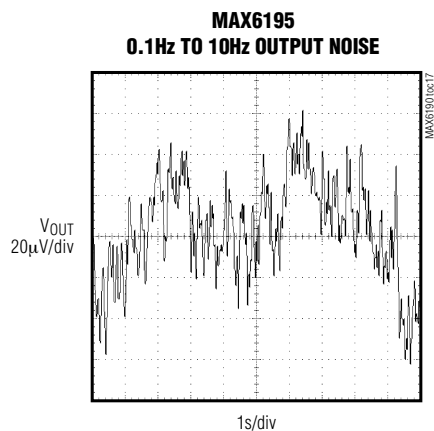
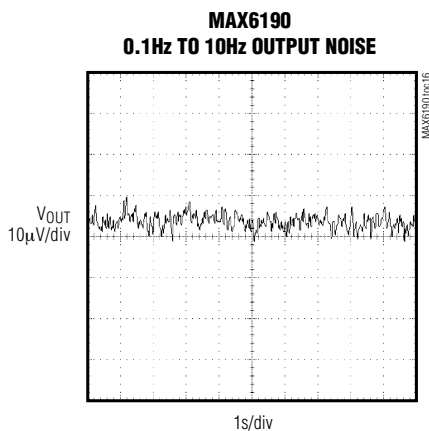
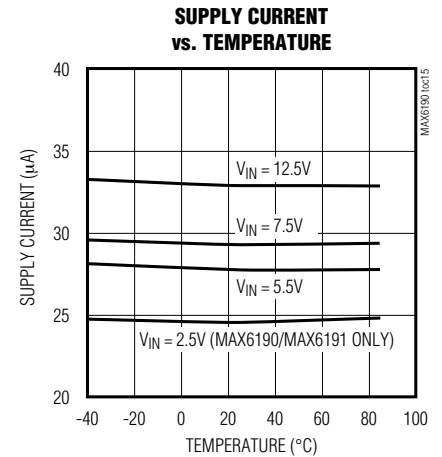
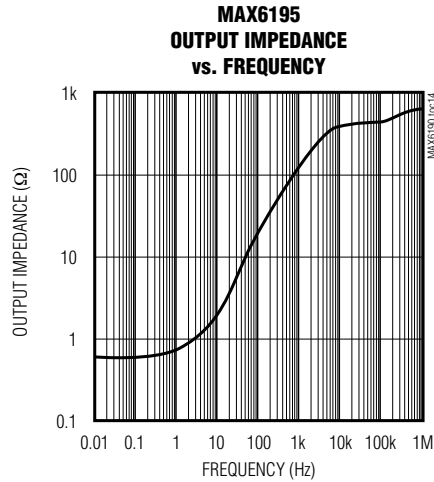
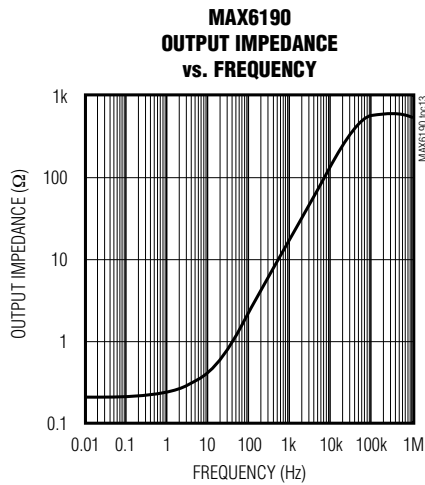
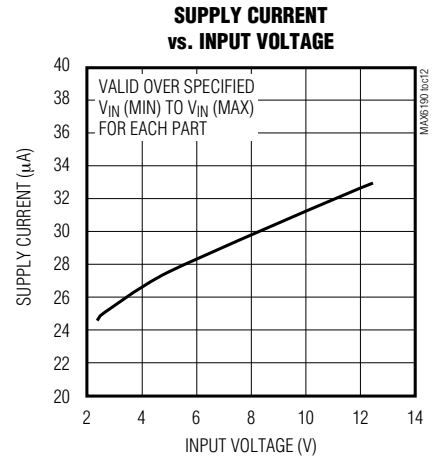
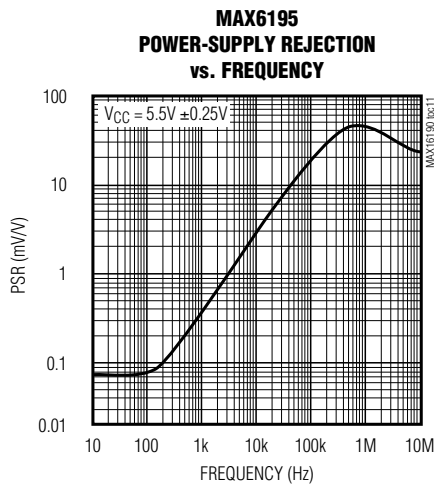
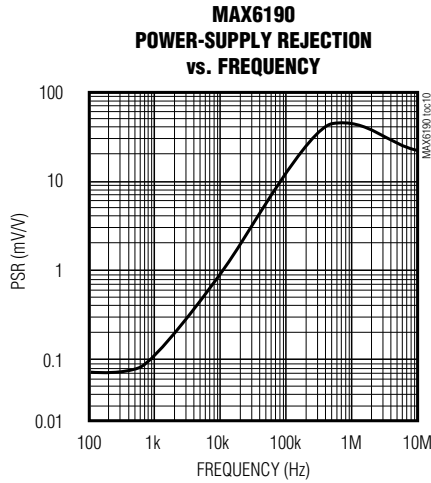

MAX6190–MAX6195/MAX6198

Precision, Micropower, Low-Dropout Voltage References

Typical Operating Characteristics (continued)

($V_{IN} = 5V$ for MAX6190/1/2/3/4/8, $V_{IN} = 5.5V$ for MAX6195; $I_{OUT} = 0nA$; $T_A = +25^{\circ}C$; unless otherwise noted.) (Note 5)

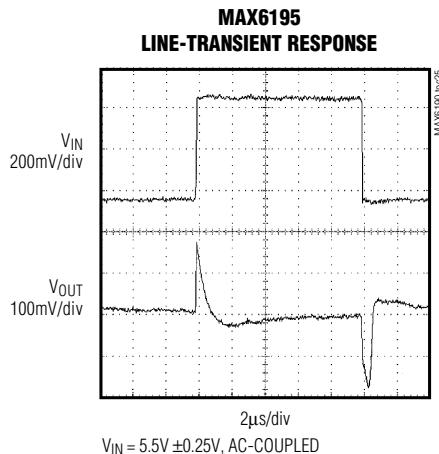
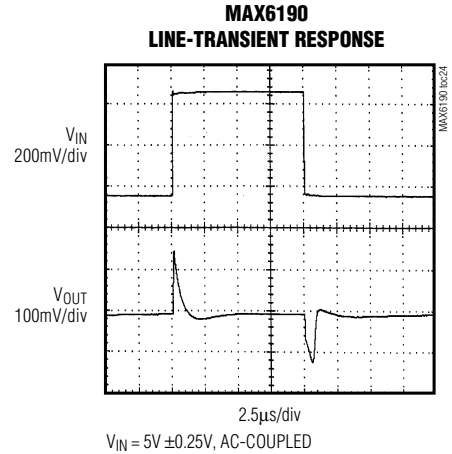
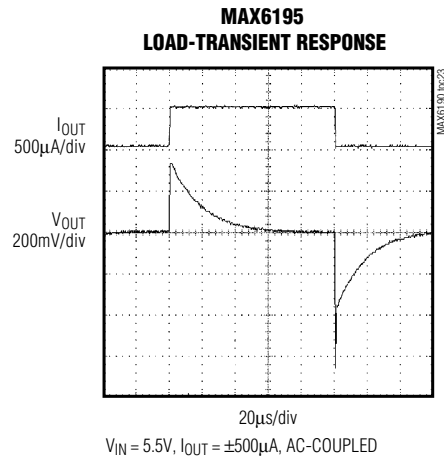
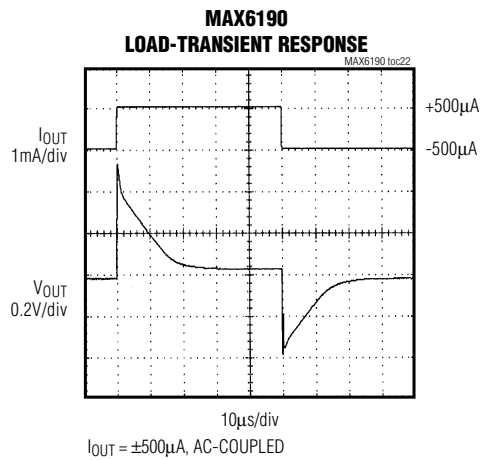
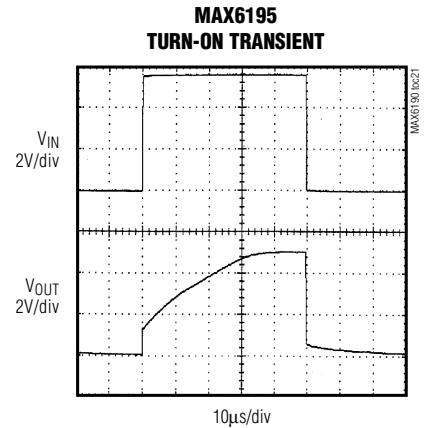
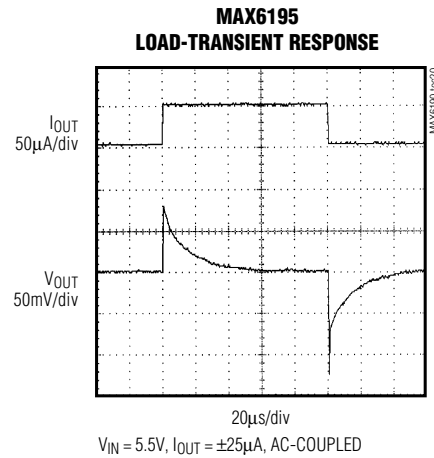
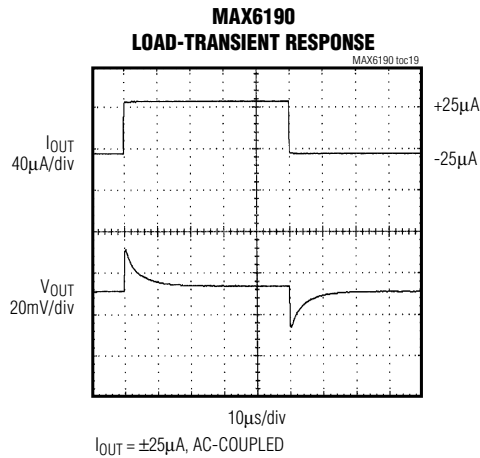

Note 5: Many of the *Typical Operating Characteristics* of the MAX6190 family are extremely similar. The extremes of these characteristics are found in the MAX6190 (1.2V output) and the MAX6195 (5.0V output) devices. The *Typical Operating Characteristics* of the remainder of the MAX6190 family typically lie between these two extremes and can be estimated based on their output voltage.

MAX6190–MAX6195/MAX6198

Precision, Micropower, Low-Dropout Voltage References

Pin Description

PIN	NAME	FUNCTION
1, 3, 5, 7, 8	N.C.	No Connection. Not internally connected.
2	IN	Supply Voltage Input
4	GND	Ground
6	OUT	Reference Voltage Output

Detailed Description

The MAX6190–MAX6195/MAX6198 precision bandgap references use a proprietary curvature-correction circuit and laser-trimmed thin-film resistors, resulting in a low temperature coefficient of <math><5\text{ppm}/^\circ\text{C}</math> and initial accuracy of better than 0.1%. These devices can sink and source up to 500 μA with <math><200\text{mV}</math> of dropout voltage, making them attractive for use in low-voltage applications.

Applications Information

Output/Load Capacitance

Devices in this family do not require an output capacitance for frequency stability. They are stable for capacitive loads from 0 to 2.2nF. However, in applications where the load or the supply can experience step changes, an output capacitor will reduce the amount of overshoot (or undershoot) and assist the circuit's transient response. Many applications do not need an external capacitor, and this family can offer a significant advantage in these applications when board space is critical.

Supply Current

The quiescent supply current of these series-mode references is a maximum of 35 μA and is virtually independent of the supply voltage, with only a 0.8 $\mu\text{A}/\text{V}$ variation with supply voltage. Unlike series references, shunt-mode references operate with a series resistor connected to the power supply. The quiescent current of a shunt-mode reference is thus a function of the input

voltage. Additionally, shunt-mode references have to be biased at the maximum expected load current, even if the load current is not present all the time. In the series-mode MAX6190 family, the load current is drawn from the input voltage only when required, so supply current is not wasted and efficiency is maximized at all input voltages. This improved efficiency can help reduce power dissipation and extend battery life.

When the supply voltage is below the minimum specified input voltage (as during turn-on), the devices can draw up to 200 μA beyond the nominal supply current. The input voltage source must be capable of providing this current to ensure reliable turn-on.

Output Voltage Hysteresis

Output voltage hysteresis is the change in the output voltage at $T_A = +25^\circ\text{C}$ before and after the device is cycled over its entire operating temperature range. Hysteresis is caused by differential package stress appearing across the bandgap core transistors. The typical temperature hysteresis value is 75ppm.

Turn-On Time

These devices typically turn on and settle to within 0.1% of their final value in 30 μs to 220 μs , depending on the device. The turn-on time can increase up to 1.5ms with the device operating at the minimum dropout voltage and the maximum load.

Positive and Negative Low-Power Voltage Reference

Figure 1 shows a typical method for developing a bipolar reference. The circuit uses a MAX681 voltage doubler/inverter charge-pump converter to power an ICL7652, thus creating a positive as well as a negative reference voltage.

MAX6190–MAX6195/MAX6198

Precision, Micropower, Low-Dropout Voltage References

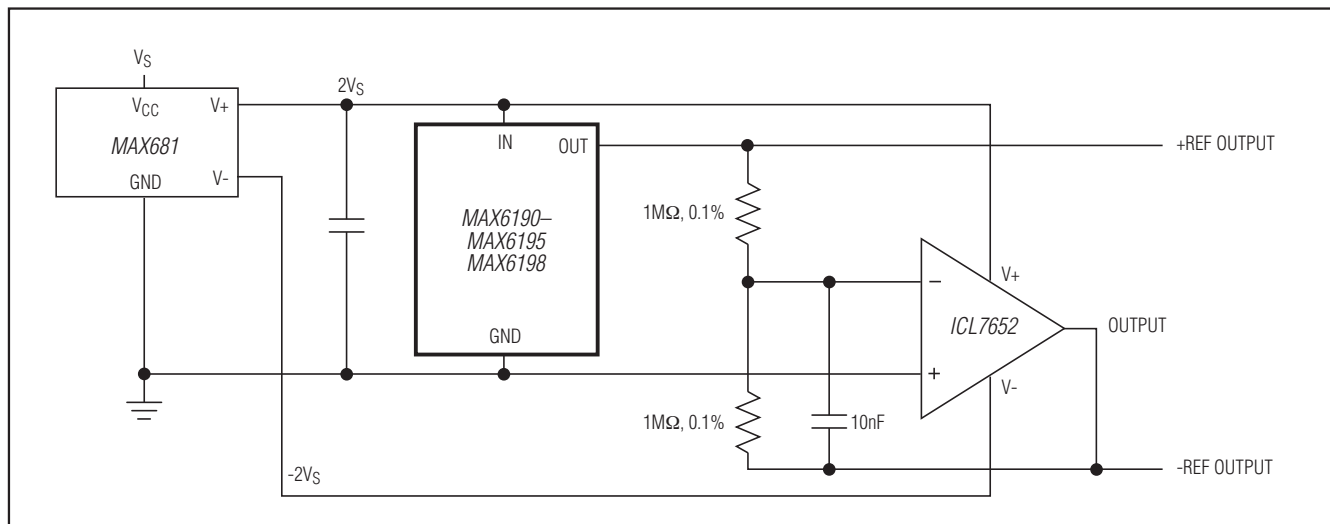

Figure 1. Positive and Negative References from Single 3V or 5V Supply

Ordering Information (continued)

PART	TEMP RANGE	PIN-PACKAGE
MAX6193 AESA+	-40°C to +85°C	8 SO
MAX6193BESA+	-40°C to +85°C	8 SO
MAX6193CESA+	-40°C to +85°C	8 SO
MAX6194 AESA+	-40°C to +85°C	8 SO
MAX6194BESA+	-40°C to +85°C	8 SO
MAX6194CESA+	-40°C to +85°C	8 SO
MAX6195 AESA+	-40°C to +85°C	8 SO
MAX6195BESA+	-40°C to +85°C	8 SO
MAX6195CESA+	-40°C to +85°C	8 SO
MAX6198 AESA+	-40°C to +85°C	8 SO
MAX6198BESA+	-40°C to +85°C	8 SO
MAX6198CESA+	-40°C to +85°C	8 SO
MAX6198AESA/V+	-40°C to +85°C	8 SO

+Denotes a lead(Pb)-free /RoHS-compliant package.

/V denotes an automotive qualified part.

Chip Information

PROCESS: BiCMOS

Typical Operating Circuit

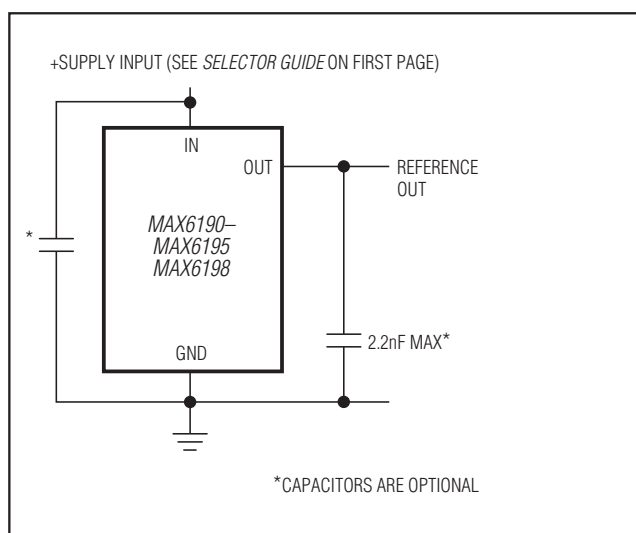

Package Information

For the latest package outline information and land patterns (footprints), go to www.maximintegrated.com/packages. Note that a "+", "#", or "-" in the package code indicates RoHS status only. Package drawings may show a different suffix character, but the drawing pertains to the package regardless of RoHS status.

PACKAGE TYPE	PACKAGE CODE	OUTLINE NO.	LAND PATTERN NO.
8 SO	S8+2	21-0041	90-0096

MAX6190–MAX6195/MAX6198

Precision, Micropower, Low-Dropout Voltage References

Revision History

REVISION NUMBER	REVISION DATE	DESCRIPTION	PAGES CHANGED
3	4/10	Added automotive grade part, added lead-free information, and made style changes	1–14



Maxim Integrated cannot assume responsibility for use of any circuitry other than circuitry entirely embodied in a Maxim Integrated product. No circuit patent licenses are implied. Maxim Integrated reserves the right to change the circuitry and specifications without notice at any time. The parametric values (min and max limits) shown in the Electrical Characteristics table are guaranteed. Other parametric values quoted in this data sheet are provided for guidance.



Компания «ЭлектроПласт» предлагает заключение долгосрочных отношений при поставках импортных электронных компонентов на взаимовыгодных условиях!

Наши преимущества:

- Оперативные поставки широкого спектра электронных компонентов отечественного и импортного производства напрямую от производителей и с крупнейших мировых складов;
- Поставка более 17-ти миллионов наименований электронных компонентов;
- Поставка сложных, дефицитных, либо снятых с производства позиций;
- Оперативные сроки поставки под заказ (от 5 рабочих дней);
- Экспресс доставка в любую точку России;
- Техническая поддержка проекта, помощь в подборе аналогов, поставка прототипов;
- Система менеджмента качества сертифицирована по Международному стандарту ISO 9001;
- Лицензия ФСБ на осуществление работ с использованием сведений, составляющих государственную тайну;
- Поставка специализированных компонентов (Xilinx, Altera, Analog Devices, Intersil, Interpoint, Microsemi, Aeroflex, Peregrine, Syfer, Eurofarad, Texas Instrument, Miteq, Cobham, E2V, MA-COM, Hittite, Mini-Circuits, General Dynamics и др.);

Помимо этого, одним из направлений компании «ЭлектроПласт» является направление «Источники питания». Мы предлагаем Вам помощь Конструкторского отдела:

- Подбор оптимального решения, техническое обоснование при выборе компонента;
- Подбор аналогов;
- Консультации по применению компонента;
- Поставка образцов и прототипов;
- Техническая поддержка проекта;
- Защита от снятия компонента с производства.



Как с нами связаться

Телефон: 8 (812) 309 58 32 (многоканальный)

Факс: 8 (812) 320-02-42

Электронная почта: org@eplast1.ru

Адрес: 198099, г. Санкт-Петербург, ул. Калинина, дом 2, корпус 4, литера А.