

SM7 Varistor Series

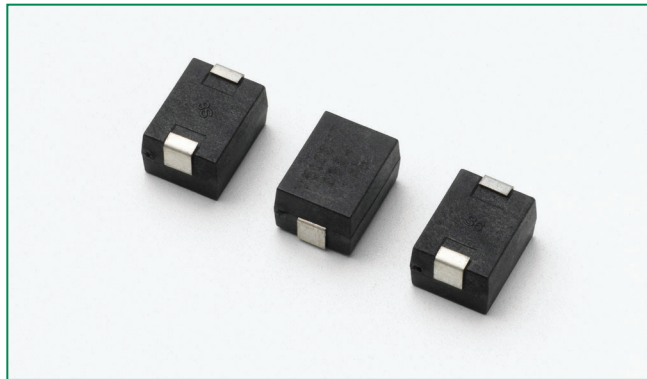

Description

The Littelfuse SM7 Series is a plastic-encapsulated surface-mount metal oxide varistor (MOV) transient voltage surge suppressor that is designed to be operated continuously across AC power lines.

The series comprises a Nylon molded package with tin plated lead frame for soldering to board. The surface mount SM7 Series is based on radial 7mm internal varistor element with similar characteristics to the Littelfuse LA / ZA series of varistor.

Agency Approvals

| Agency | Agency File Number |
|--------|--------------------|
| | E320116 |

Features

- Electrical equivalent to leaded types LA/ZA series
- AC Voltage Rating 115 to 510VAC rms
- No De-Rating up to 85°C ambient
- Good solderability
- Available in tape and reel
- Application of AC power meters

Absolute Maximum Ratings

• For ratings of individual members of a series, see Device Ratings and Specifications chart

| Continuous | SM7 Series | Units |
|--|-------------|------------|
| Steady State Applied Voltage: | | |
| AC Voltage Range ($V_{M(AC)(RMS)}$) | 115 to 510 | V |
| DC Voltage Range ($V_{M(DC)}$) | 153 to 675 | V |
| Transients: | | |
| Peak Pulse Current (I_{TM}) | | |
| For 8/20 μ s Current Wave (See Figure 2) | 1200 | A |
| Single Pulse Energy Range | | |
| For 10/1000 μ s Current Wave (W_{TM}) | 10 to 40 | J |
| Operating Ambient Temperature Range (T_A) | -40 to +85 | °C |
| Storage Temperature Range (T_{STG}) | -55 to +125 | °C |
| Temperature Coefficient (α^V) of Clamping Voltage (V_C) at Specified Test Current | <0.01 | %/°C |
| Hi-Pot Encapsulation (COATING Isolation Voltage Capability) (Dielectric must withstand indicated DC voltage for one minute per MIL-STD 202, Method 301) | 2500 | V |
| COATING Insulation Resistance | 1000 | M Ω |

CAUTION: Stresses above those listed in "Absolute Maximum Ratings" may cause permanent damage to the device. This is a stress only rating and operation of the device at these or any other conditions above those indicated in the operational sections of this specification is not implied.

SM7 Series Ratings & Specifications

| Part Number | Maximum Rating (85°C) | | | | Specifications (25°C) | | | | |
|------------------------|------------------------|---------------------|--------------------------|-----------------------------|---|--------------------|---|--------|------------------------------|
| | Continuous | | Transient | | Varistor Voltage at 1mA DC Test Current | | Maximum Clamping Voltage 8 x 20 μ s | | Typical Capacitance f = 1MHz |
| | V _{RMS} | V _{DC} | Energy 10 x 1000 μ s | Peak Current 8 x 20 μ s | | | | | |
| V _{M(AC)} (V) | V _{M(DC)} (V) | W _{TM} (J) | I _{TM} (A) | V _{NOM} Min (V) | V _{NOM} Max (V) | V _C (V) | I _{PK} (A) | C (pF) | |
| V115SM7 | 115 | 153 | 10 | 1200 | 162 | 198 | 300 | 10 | 200 |
| V130SM7 | 130 | 175 | 11 | 1200 | 184 | 228 | 340 | 10 | 180 |
| V140SM7 | 140 | 180 | 12 | 1200 | 198 | 242 | 360 | 10 | 160 |
| V150SM7 | 150 | 200 | 13 | 1200 | 212 | 268 | 395 | 10 | 150 |
| V175SM7 | 175 | 225 | 15 | 1200 | 247 | 303 | 455 | 10 | 130 |
| V230SM7 | 230 | 300 | 20 | 1200 | 324 | 396 | 595 | 10 | 100 |
| V250SM7 | 250 | 330 | 21 | 1200 | 354 | 429 | 650 | 10 | 90 |
| V275SM7 | 275 | 369 | 23 | 1200 | 389 | 473 | 710 | 10 | 80 |
| V300SM7 | 300 | 405 | 25 | 1200 | 420 | 517 | 775 | 10 | 70 |
| V320SM7 | 320 | 420 | 25 | 1200 | 462 | 565 | 850 | 10 | 65 |
| V385SM7 | 385 | 505 | 27 | 1200 | 558 | 682 | 1025 | 10 | 60 |
| V420SM7 | 420 | 560 | 30 | 1200 | 610 | 748 | 1120 | 10 | 55 |
| V460SM7 | 460 | 615 | 37 | 1200 | 640 | 790 | 1190 | 10 | 55 |
| V480SM7 | 480 | 640 | 35 | 1200 | 670 | 825 | 1240 | 10 | 50 |
| V510SM7 | 510 | 675 | 40 | 1200 | 735 | 910 | 1200 | 10 | 45 |

NOTE: SM7 series devices are recognized under UL file # E320116

Peak Current, Energy and Power Derating Curve

For applications exceeding 85°C ambient temperature, the peak surge current and energy ratings must be reduced as shown below

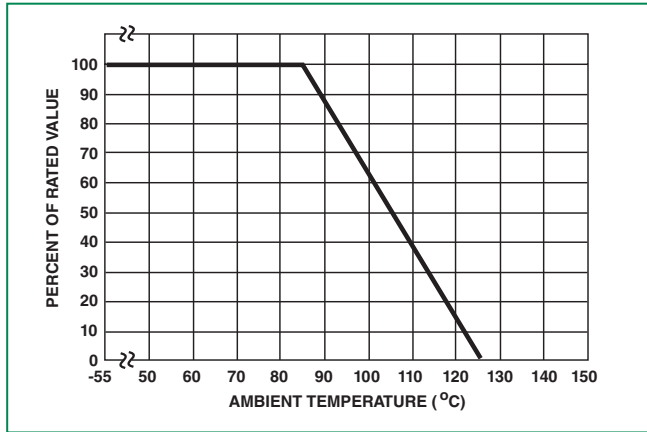

V-I Limit Curves

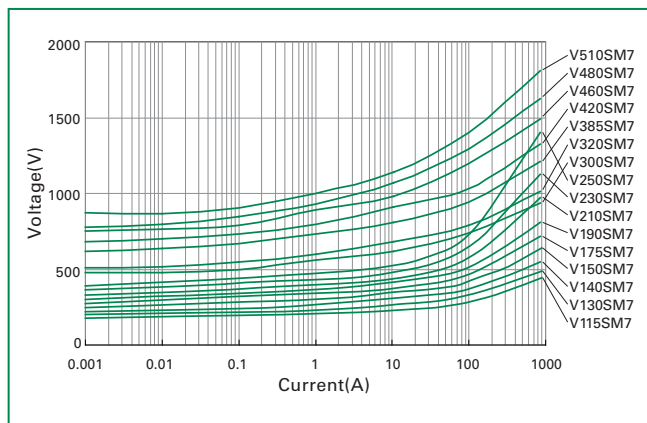

NOTE: If pulse ratings are exceeded, a shift of $V_{N(DC)}$ (at specified current) of more than $\pm 10\%$ could result. This type of shift, which normally results in a decrease of $V_{N(DC)}$, may result in the device not meeting the original published specifications, but it does not prevent the device from continuing to function, and to provide ample protection.

Peak Pulse Current Test Waveform for Clamping Voltage

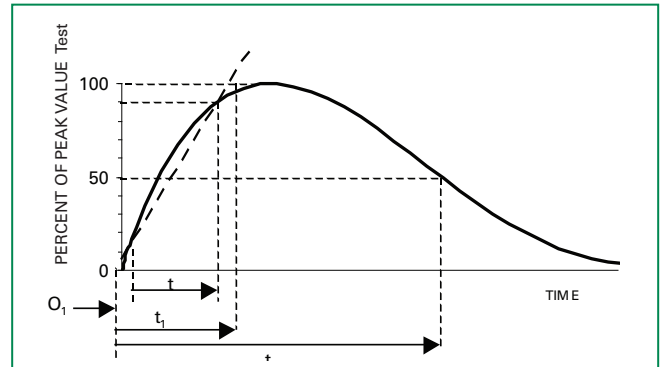

O_1 = Virtual Origin of Wave

T = Time from 10% to 90% of Peak

T_1 = Rise Time = $1.25 \times T$

T_2 = Decay Time

Example - For an 8/20 μ s Current Waveform:

8μ s = T_1 = Rise Time

20μ s = T_2 = Decay Time

Pulse Rating Curves

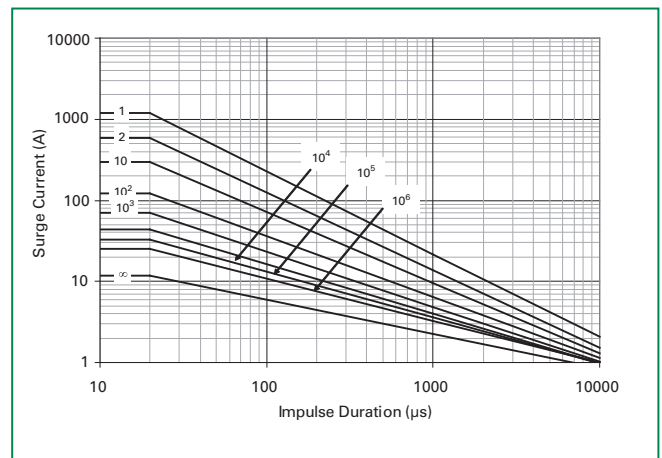

Lead (Pb) Soldering Recommendations

The principal techniques used for the soldering of components in surface mount technology are IR Re-flow and Wave soldering. Typical profiles are shown on the right.

The terminals of SM7 series devices are tin plated copper, and the recommended solder is 62/36/2 (Sn/Pb/Ag), 60/40 (Sn/Pb) or 63/37 (Sn/Pb). Littelfuse also recommends an RMA solder flux.

Wave soldering is the most strenuous of the processes. To avoid the possibility of generating stresses due to thermal shock, a preheat stage in the soldering process is recommended, and the peak temperature of the solder process should be rigidly controlled.

When using a reflow process, care should be taken to ensure that the SM7 chip is not subjected to a thermal gradient steeper than 4 degrees per second; the ideal gradient being 2 degrees per second. During the soldering process, preheating to within 100 degrees of the solder's peak temperature is essential to minimize thermal shock.

Once the soldering process has been completed, it is still necessary to ensure that any further thermal shocks are avoided. One possible cause of thermal shock is hot printed circuit boards being removed from the solder process and subjected to cleaning solvents at room temperature. The boards must be allowed to cool gradually to less than 50°C before cleaning.

Reflow Solder Profile

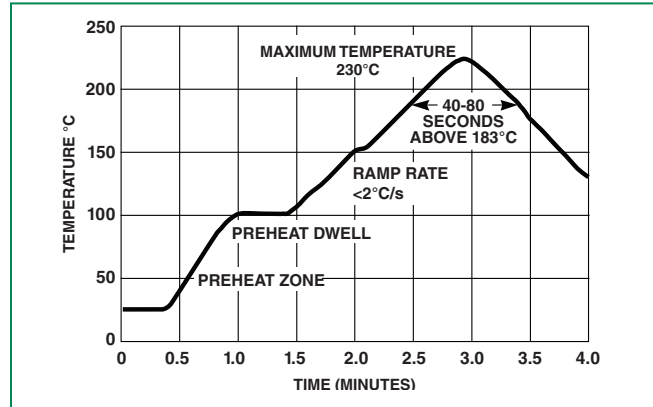

Wave Solder Profile

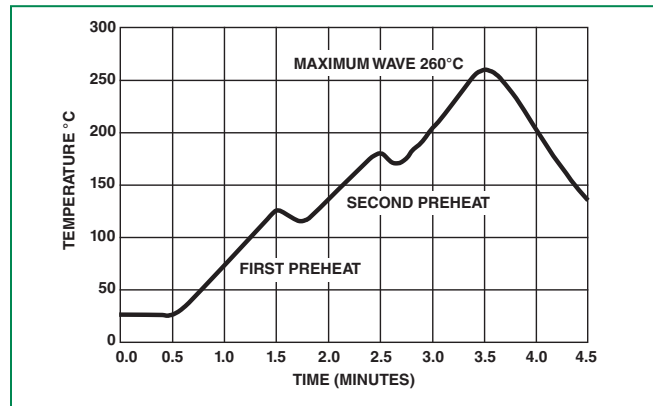

Lead-free (Pb-free) Soldering Recommendations

The terminals of SM7 series devices are tin plated copper, and the recommended Lead-free solder is 96.5/3.0/0.5 (SnAgCu) with an RMA flux, though there is a wide selection of pastes and fluxes available that should be compatible.

The reflow profile must be constrained by the maximums in the Lead-free Reflow Profile. For Lead-free Wave soldering, the Wave Solder Profile still applies.

Note: the Lead-free paste, flux and profile were used for evaluation purposes by Littelfuse, based upon industry standards and practices. There are multiple choices of all three available, it is advised that the customer explores the optimum combination for their process as processes vary considerably from site to site.

Lead-free Re-flow Solder Profile

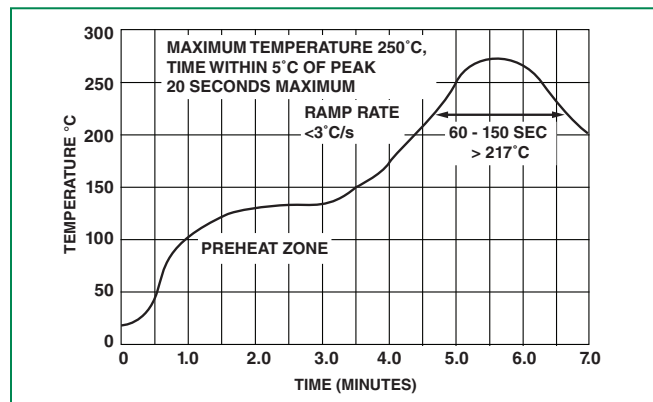

Product Dimensions

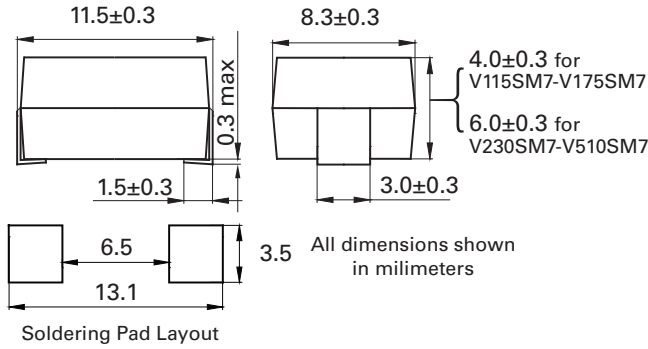

Part Numbering System

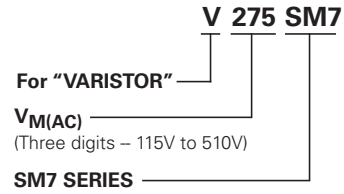

Tape & Reel Specifications

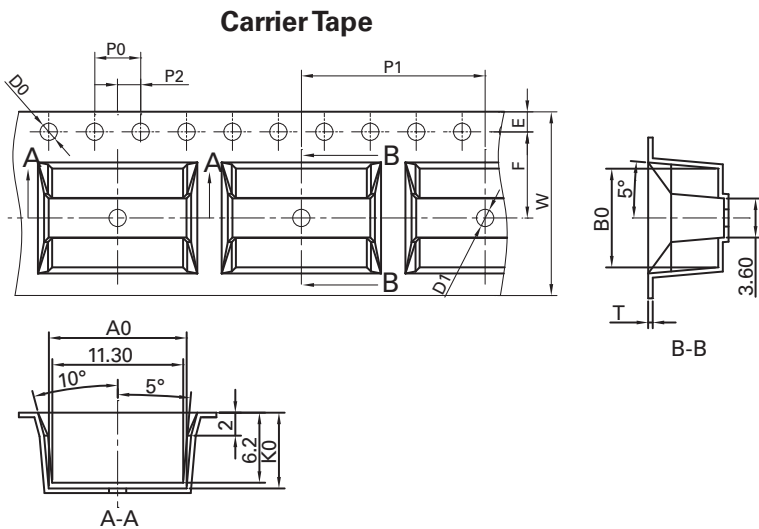

| | mm |
|-----------|----------------|
| W | 16.00±0.30 |
| T | 0.40±0.05 |
| A0 | 11.80±0.10 |
| B0 | 8.60±0.10 |
| K0 | 6.80±0.10 |
| E | 1.75±0.10 |
| F | 7.50±0.10 |
| P0 | 4.00±0.10 |
| P1 | 16.00±0.10 |
| P2 | 2.00±0.10 |
| D0 | Ø1.50 +0.10/-0 |
| D1 | Ø1.50 +0.10/-0 |

- NOTES:
 1) All dimensions per EIA-481-c
 2) 10 pitches cumulative tolerance on tape ±0.20mm
 3) Quantity per 13 inch (330 mm) reel: 600 pcs



Компания «ЭлектроПласт» предлагает заключение долгосрочных отношений при поставках импортных электронных компонентов на взаимовыгодных условиях!

Наши преимущества:

- Оперативные поставки широкого спектра электронных компонентов отечественного и импортного производства напрямую от производителей и с крупнейших мировых складов;
- Поставка более 17-ти миллионов наименований электронных компонентов;
- Поставка сложных, дефицитных, либо снятых с производства позиций;
- Оперативные сроки поставки под заказ (от 5 рабочих дней);
- Экспресс доставка в любую точку России;
- Техническая поддержка проекта, помощь в подборе аналогов, поставка прототипов;
- Система менеджмента качества сертифицирована по Международному стандарту ISO 9001;
- Лицензия ФСБ на осуществление работ с использованием сведений, составляющих государственную тайну;
- Поставка специализированных компонентов (Xilinx, Altera, Analog Devices, Intersil, Interpoint, Microsemi, Aeroflex, Peregrine, Syfer, Eurofarad, Texas Instrument, Miteq, Cobham, E2V, MA-COM, Hittite, Mini-Circuits, General Dynamics и др.);

Помимо этого, одним из направлений компании «ЭлектроПласт» является направление «Источники питания». Мы предлагаем Вам помощь Конструкторского отдела:

- Подбор оптимального решения, техническое обоснование при выборе компонента;
- Подбор аналогов;
- Консультации по применению компонента;
- Поставка образцов и прототипов;
- Техническая поддержка проекта;
- Защита от снятия компонента с производства.



Как с нами связаться

Телефон: 8 (812) 309 58 32 (многоканальный)

Факс: 8 (812) 320-02-42

Электронная почта: org@eplast1.ru

Адрес: 198099, г. Санкт-Петербург, ул. Калинина, дом 2, корпус 4, литера А.