

PIC32MX

clicker

new idea just a click away

A compact starter kit with your favorite microcontroller and a socket for click™ add-on boards. New ideas are just a click away.



TO OUR VALUED CUSTOMERS

I want to express my thanks to you for being interested in our products and for having confidence in MikroElektronika.

The primary aim of our company is to design and produce high quality electronic products and to constantly improve the performance thereof in order to better suit your needs.

A stylized, handwritten signature in black ink, consisting of several overlapping loops and a long horizontal stroke extending to the right.

Nebojsa Matic
General Manager

Table of Contents

1. What is PIC32MX clicker?	4	step 4 - Uploading .HEX file	12
2. Power supply	6	step 5 - Finish upload	13
3. PIC32MX534F064H microcontroller	8	Programming with mikroProg™ Programmer	14
Key microcontroller features	8	5. mikroProg Suite™ for PIC® Software	16
4. Programming the microcontroller	9	6. Buttons and LEDs	18
Programming with mikroBootloader	10	7. click™ boards are plug and play!	20
step 1 - Connecting PIC32MX clicker	10	8. Pinout	22
step 2 - Browsing for .HEX file	11	9. Dimensions	23
step 3 - Selecting .HEX file	11		

1. What is PIC32MX clicker?

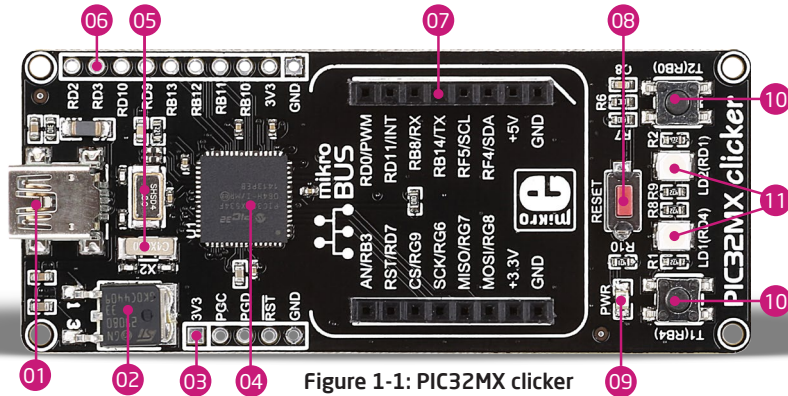

Figure 1-1: PIC32MX clicker

- 01 USB Mini-B connector
- 02 3.3V Voltage regulator
- 03 mikroProg™ Programmer connector
- 04 PIC32MX534F064H microcontroller
- 05 Crystal oscillators (8MHz and 32kHz)
- 06 Connection pads
- 07 mikroBUS™ socket
- 08 RESET button
- 09 Power indication LED
- 10 Additional buttons
- 11 Additional LEDs

PIC32MX clicker is an amazingly compact starter development kit which brings innovative mikroBUS™ host socket to your favorite microcontroller. It features the **PIC32MX534F064H** 32-bit microcontroller, two indication LEDs, two general purpose buttons, reset button, USB MINI-B connector and a single mikroBUS™ host socket. mikroProg connector and pads for interfacing with external electronics are provided as well. mikroBUS™ host connector consists of two 1x8 female headers with **SPI**, **I²C**, **UART**, **RST**, **PwM**, **Analog** and **Interrupt** lines as well as **3.3V**, **5V** and **GND** power lines. **PIC32MX clicker** board can be powered over USB cable. On-board power circuitry generates 3.3V and 5V. Power diode (GREEN) indicates the presence of power supply.

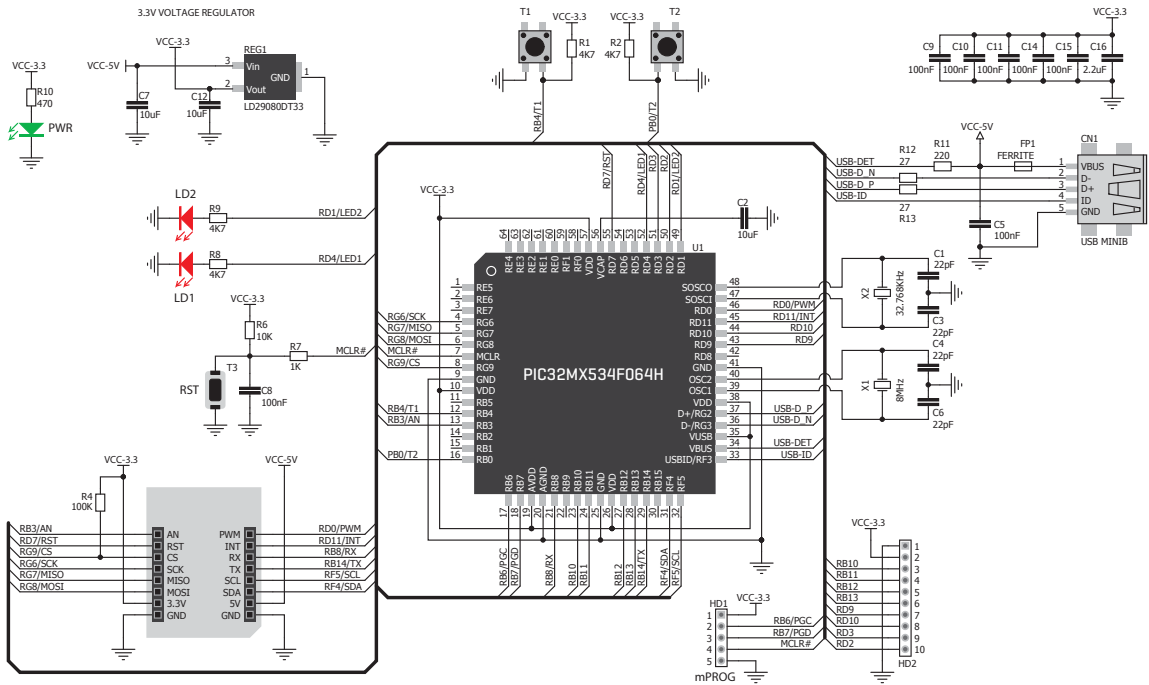

Figure 1-2: PIC32MX clicker schematic

2. Power supply

When the board is powered up the power indication LED will be automatically turned on. The USB connection can provide up to 500mA of current which is more than enough for the operation of all on-board and additional modules.

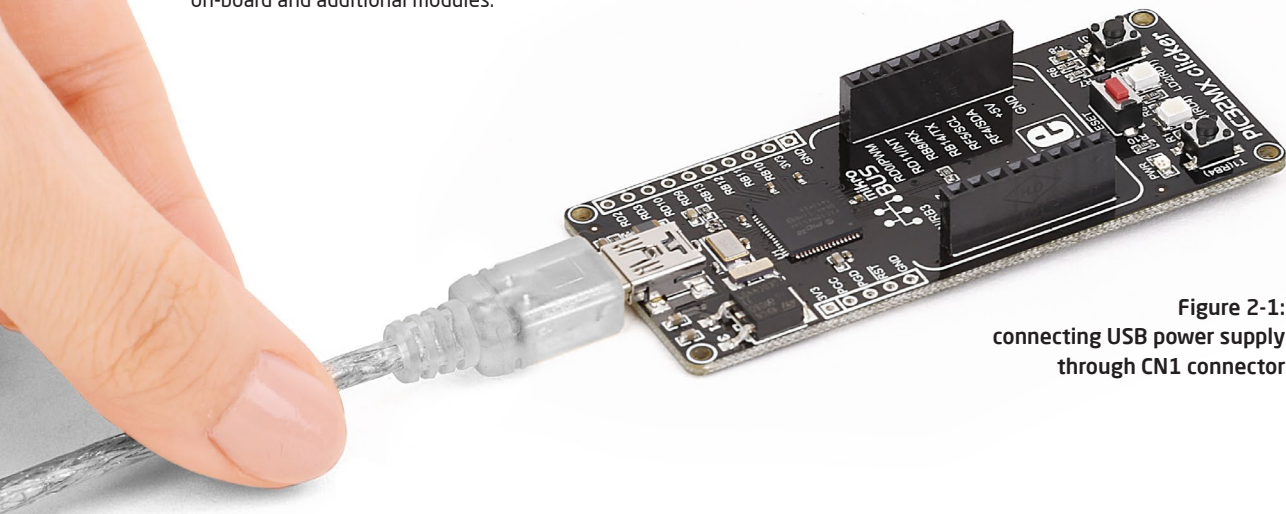

Figure 2-1:
connecting USB power supply
through CN1 connector

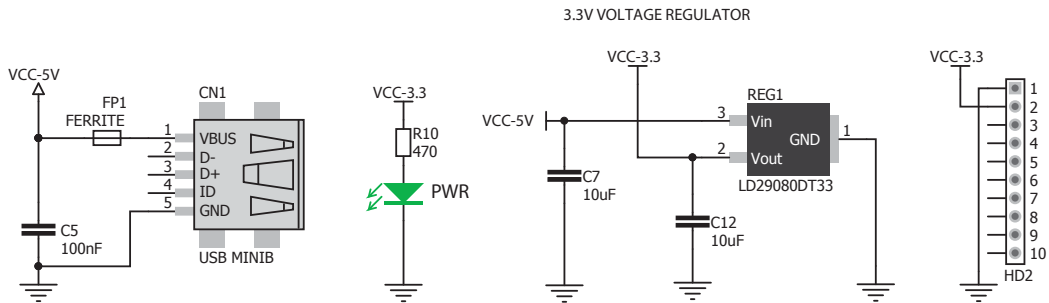

Figure 2-2: Power supply schematic

3. PIC32MX534F064H microcontroller

The PIC32MX clicker development tool comes with the **PIC32MX534F064H** microcontroller. This 32-bit MIPS M4K Core high performance microcontroller is rich with on-chip peripherals and features 64KB of Flash and 16KB RAM. It has integrated full speed USB 2.0. support.

Key microcontroller features

- 80MHz/105DMIPS, 32-bit MIPS M4K Core;
- 64KB Flash (plus 12K boot Flash);
- 16KB RAM (can execute from RAM);
- 53 I/O pins;
- SPI, I2C, A/D, CAN
- 16-bit Digital Timers;
- Internal Oscillator 8MHz, 32kHz;
- RTCC, etc.

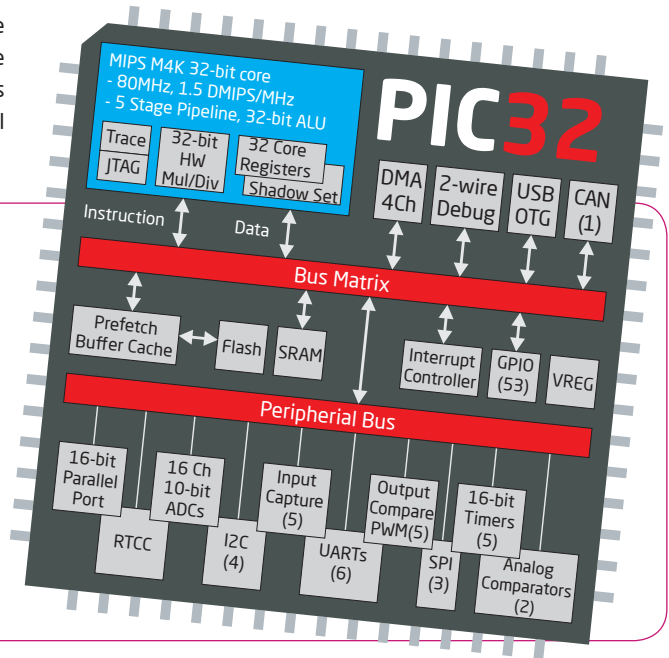

4. Programming the microcontroller

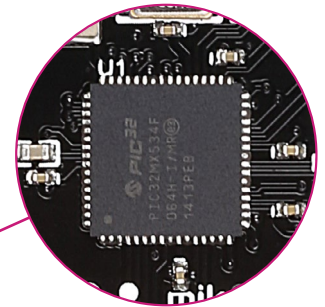
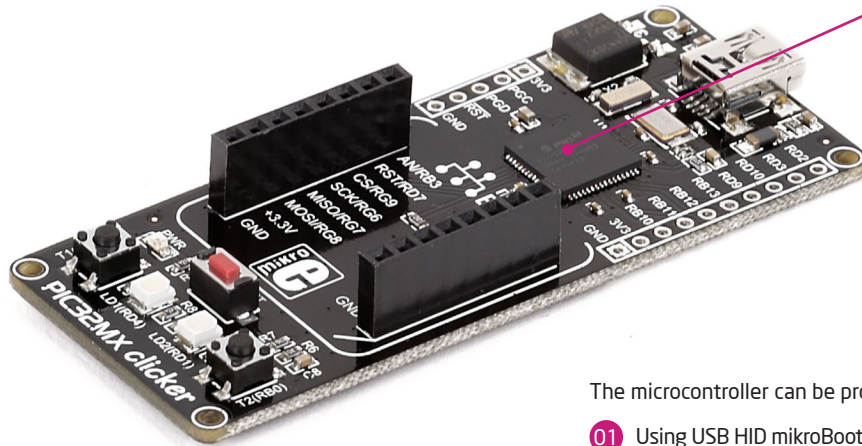

Figure 4-1:
PIC32MX534F064H
microcontroller

The microcontroller can be programmed in two ways:

- 01 Using USB HID mikroBootloader,
- 02 Using external mikroProg™ for PIC®, dsPIC®, PIC32® programmer.

Programming with mikroBootloader

You can program the microcontroller with bootloader which is preprogrammed by default. To transfer .hex file from a PC to MCU you need bootloader software (**mikroBootloader USB HID**) which can be downloaded from:

 www.mikroe.com/downloads/get/2209/pic32mx_clicker_bootloader_v100.zip

After the mikroBootloader software is downloaded, unzip it to desired location and start it.

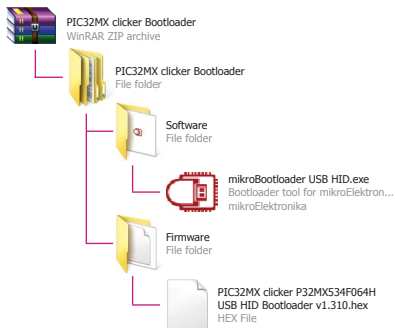

step 1 – Connecting PIC32MX clicker



Figure 4-2: USB HID mikroBootloader window

01 To start, connect the USB cable, or if already connected press the **Reset** button on your PIC32MX clicker. Click the **Connect** button within 5s to enter the bootloader mode, otherwise existing microcontroller program will execute.

step 2 – Browsing for .HEX file



Figure 4-3: Browse for HEX

- 01 Click the **Browse for HEX** button and from a pop-up window (**Figure 3.4**) choose the .HEX file which will be uploaded to MCU memory.

step 3 – Selecting .HEX file

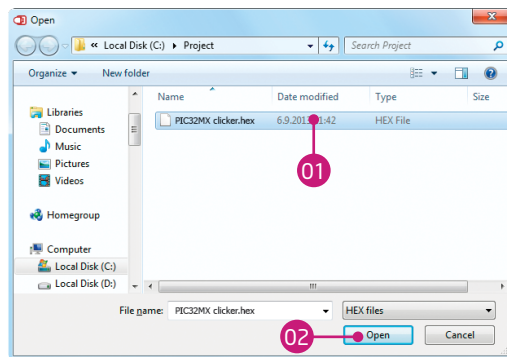

Figure 4-4: Selecting HEX

- 01 Select .HEX file using open dialog window.
- 02 Click the **Open** button.

step 4 – Uploading .HEX file



Figure 4-5: Begin uploading

- 01** To start .HEX file bootloading click the **Begin uploading** button.



Figure 4-6: Progress bar

- 01** Progress bar enables you to monitor .HEX file uploading.

step 5 – Finish upload

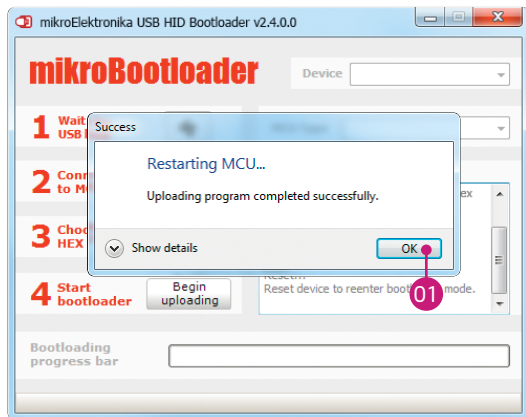

Figure 4-7: Restarting MCU

- 01 Click **OK** button after the uploading process is finished.
- 02 Press **Reset** button on PIC32MX clicker board and wait for 5 seconds. Your program will run automatically.



Programming with mikroProg™ programmer

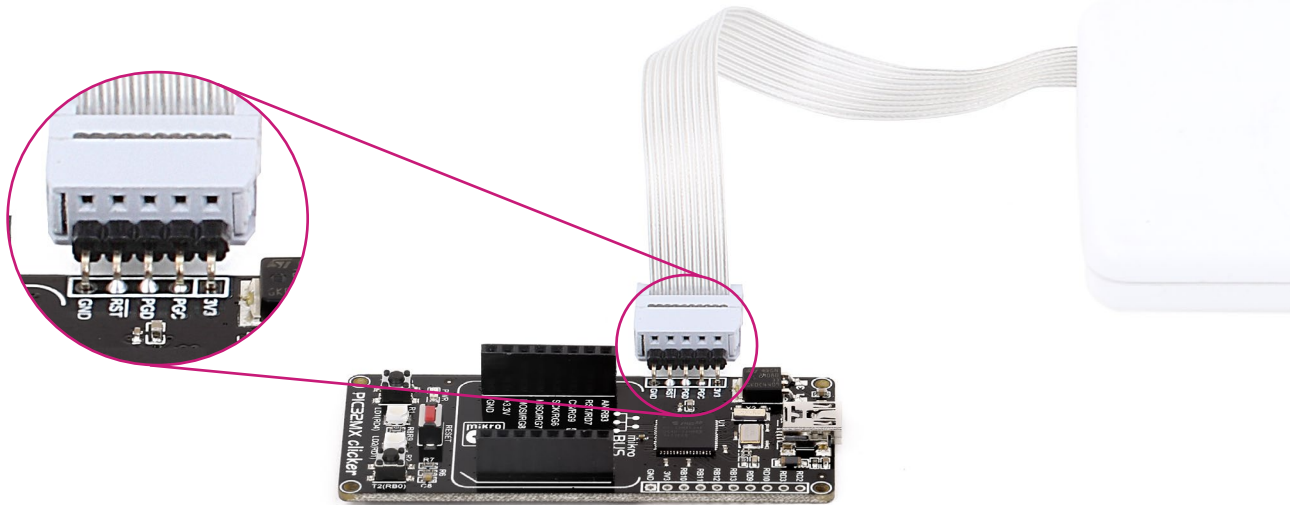

Figure 4-9: mikroProg™ connector

The microcontroller can be programmed with external **mikroProg™ for PIC®, dsPIC® and PIC32® programmer** and **mikroProg Suite™ for PIC® software**. The external programmer is connected to the development system via 1x5 mikroProg™ connector, **Figure 4-9**. **mikroProg™** is a fast USB 2.0 programmer with hardware debugger support. It supports PIC10®, PIC12®, PIC16®, PIC18®, dsPIC30/33®, PIC24® and PIC32® devices from Microchip®. Outstanding performance, easy operation and elegant design are it's key features.

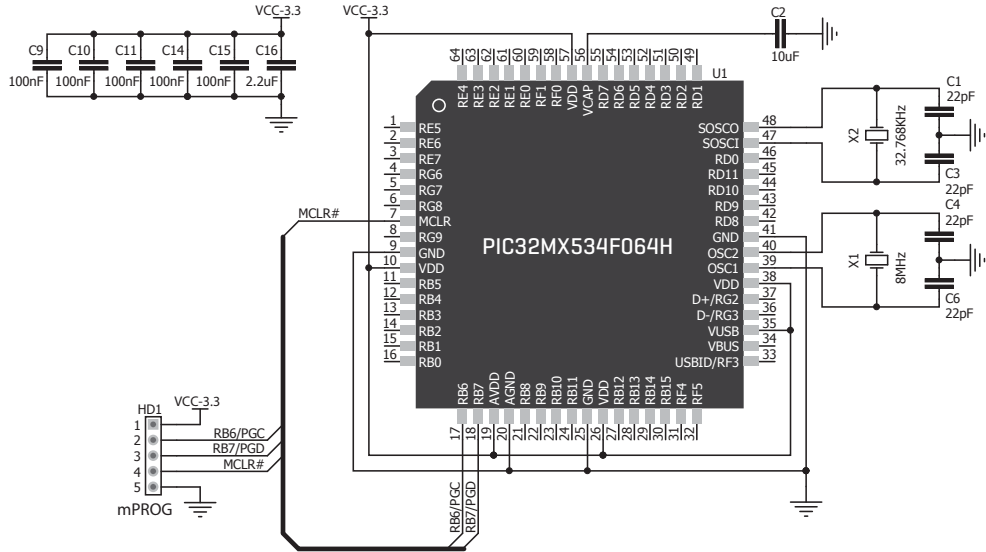
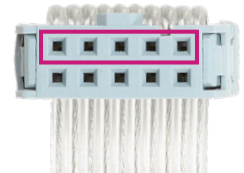

Figure 4-10: mikroProg™ connection schematic

NOTE | Make sure to use only the front row of mikroProg's IDC10 connector (side with a knob and incision) when connecting it to 1x5 header on your PIC32MX clicker board.



5. mikroProg Suite™ for PIC® Software



The **mikroProg™** programmer requires special programming software called **mikroProg Suite™ for PIC®**. It can be used for programming all Microchip® microcontroller families, including PIC10®, PIC12®, PIC16®, PIC18®, dsPIC30/33®, PIC24® and PIC32®. The software has intuitive interface and SingleClick™ programming technology. Just download the latest version of **mikroProg Suite™** and your programmer is ready to program new devices. **mikroProg Suite™** is updated regularly, at least four times a year, so your programmer will be more and more powerful with each new release.

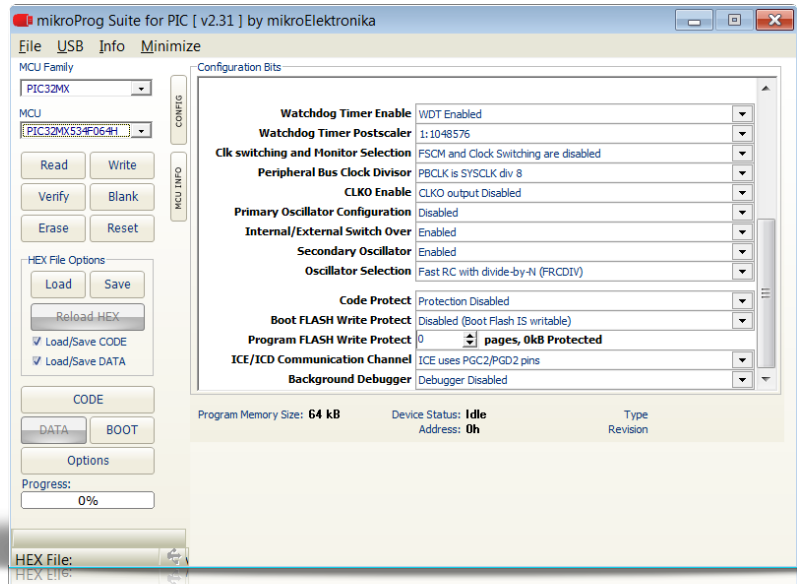
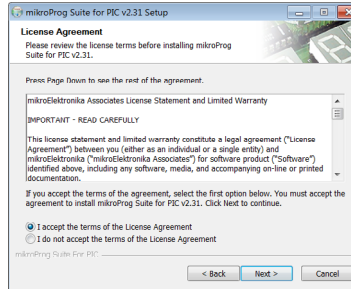

Figure 5-1: Main window of mikroProg Suite™ for PIC® programming software

Software Installation Wizard



01 Start Installation



02 Accept EULA and continue

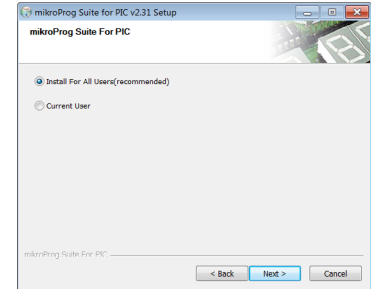

03 Install for all users

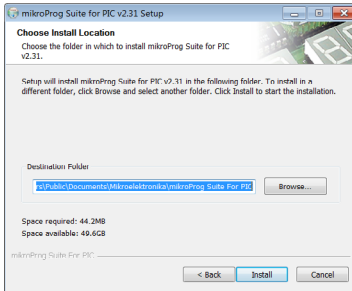

04 Choose destination folder

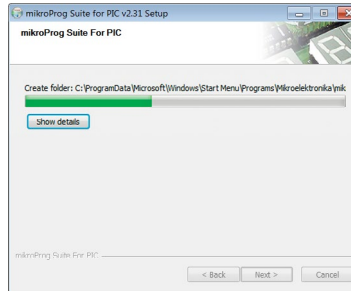

05 Installation in progress

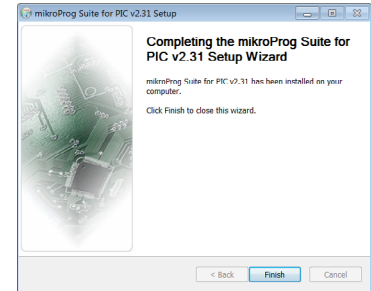

06 Finish installation

6. Buttons and LEDs

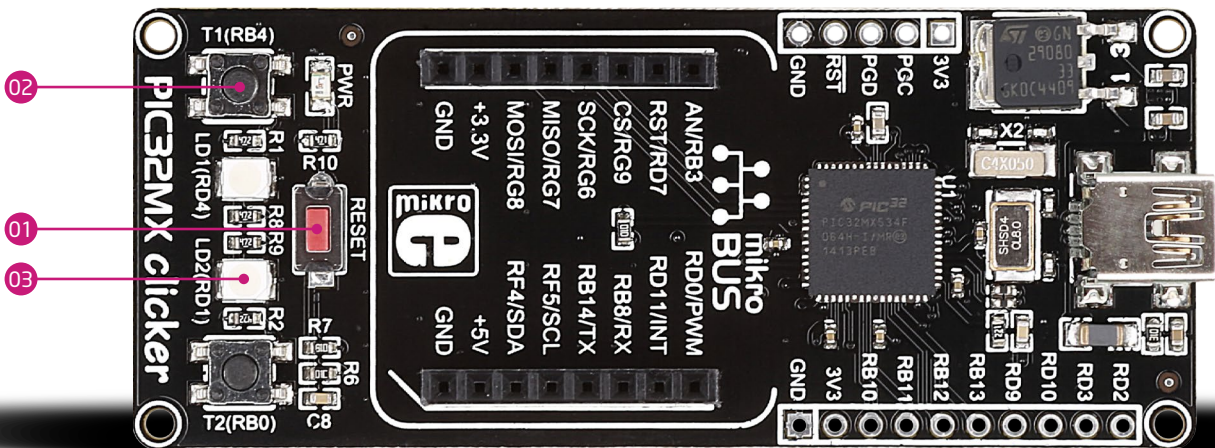

Figure 6-1: Two buttons, two LEDs and a reset button

The board also contains **01** reset button and a pair of **02** buttons and **03** LEDs. Each of these additional peripheral are located in the bottom area of the board. **Reset button** is used to manually reset the microcontroller. Pressing the reset button will generate low voltage level on microcontroller reset pin. **LEDs** can be used for visual indication of the logic state on two pins (**RD4** and **RD1**). An active LED indicates that a logic high (1) is present on the pin. Pressing any of these **buttons** can change the logic state of the microcontroller pins (**RB4** and **RB0**) from logic high (1) to logic low (0).

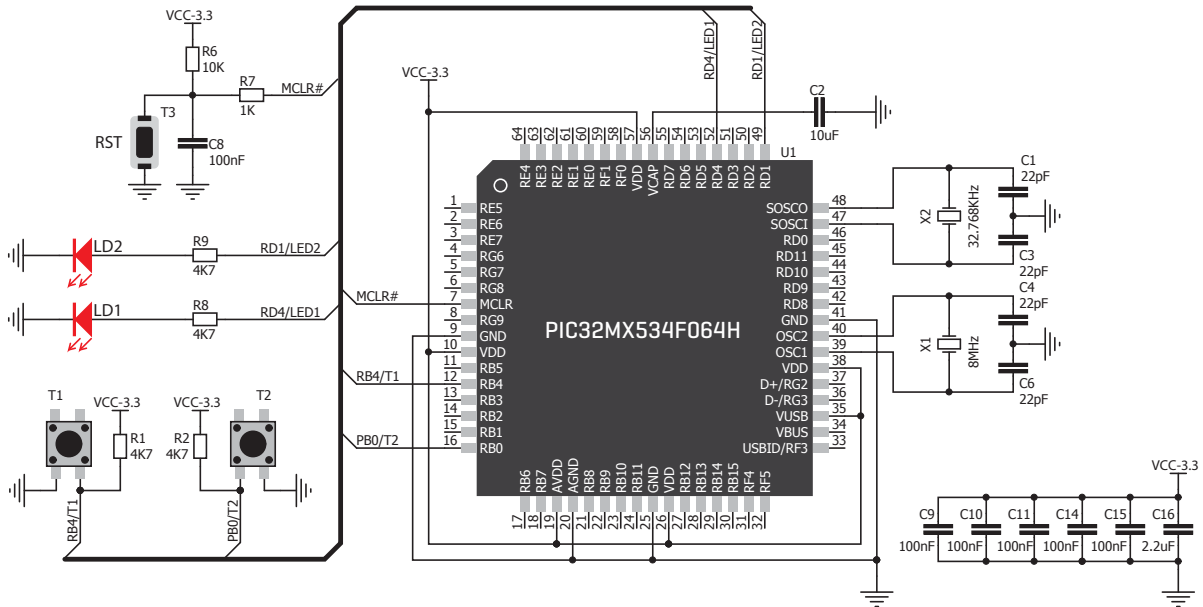

Figure 6-2: Other modules connection schematic

7. click™ boards are plug and play!

Up to now, MikroElektronika has released more than 100 mikroBUS™ compatible **click™ boards**. On the average, one click™ board is released per week. It is our intention to provide you with as many add-on boards as possible, so you will be able to expand your development board with additional functionality. Each board comes with a set of working example codes. Please visit the click™ boards webpage for the complete list of currently available boards:

 www.mikroe.com/click



Figure 7-1:
PIC32MX clicker driving
GSM click™ board

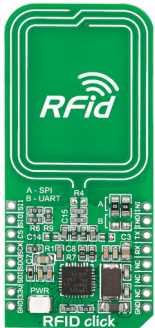

RFID click™

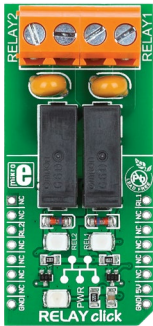

Relay click™

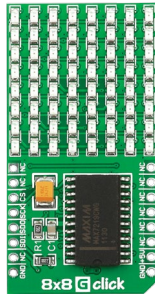

8x8 click™

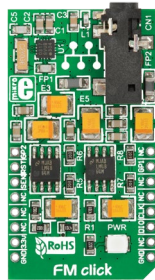

FM click™



Bluetooth2 click™



Thunder click™

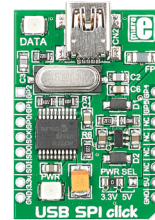

USB SPI click™

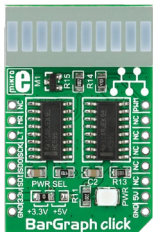

BarGraph click™

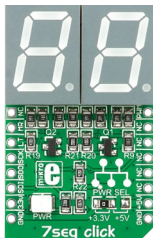

7seg click™



THERMO click™

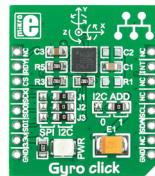

Gyro click™

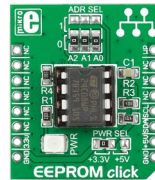

EEPROM click™

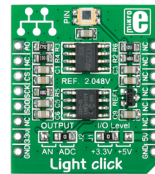

Light click™

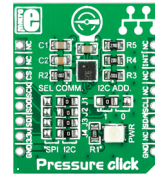

Pressure click™

8. Pinout

In addition to the mikroBUS™ socket, the PIC32MX clicker has a row of 9 pins with Analog, Interrupt, I2C, UART and PWM lines (+ GND) for connecting external electronics.

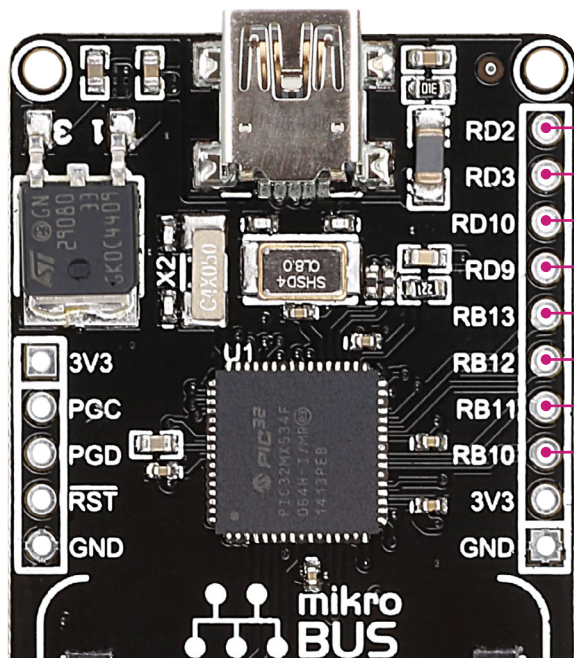

RD2	SDA3	U1RX	PWM3
RD3	SCL3	U1TX	PWM4
RD10	INT3	SCL1	
RD9	INT2	SDA1	
RB13	AN13		
RB12	AN12		
RB11	AN11		
RB10	AN10		



- Analog Lines
- Interrupt Lines
- I2C Lines
- UART lines
- PWM lines

9. Dimensions

Legend

 mm
 mils

Mounting hole size

 2 mm
 79 mils

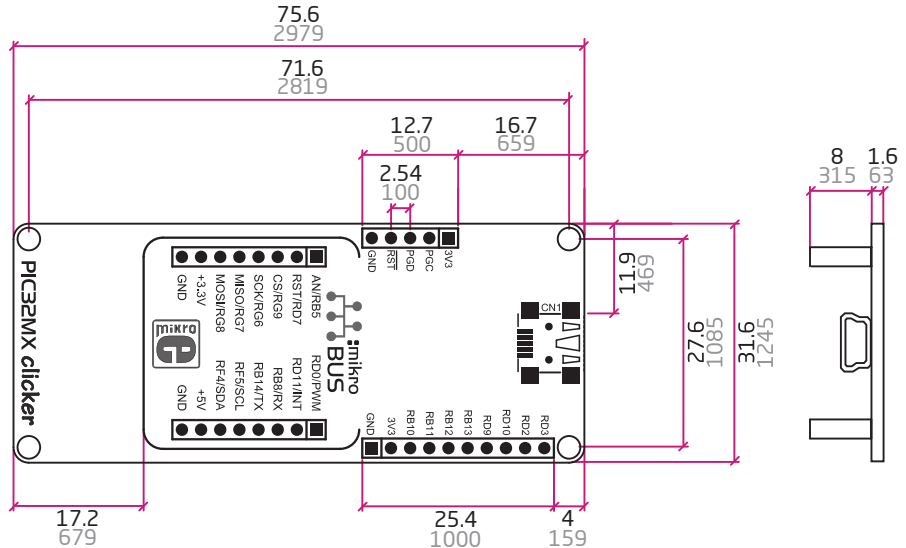

DISCLAIMER

All the products owned by MikroElektronika are protected by copyright law and international copyright treaty. Therefore, this manual is to be treated as any other copyright material. No part of this manual, including product and software described herein, may be reproduced, stored in a retrieval system, translated or transmitted in any form or by any means, without the prior written permission of MikroElektronika. The manual PDF edition can be printed for private or local use, but not for distribution. Any modification of this manual is prohibited.

MikroElektronika provides this manual 'as is' without warranty of any kind, either expressed or implied, including, but not limited to, the implied warranties or conditions of merchantability or fitness for a particular purpose.

MikroElektronika shall assume no responsibility or liability for any errors, omissions and inaccuracies that may appear in this manual. In no event shall MikroElektronika, its directors, officers, employees or distributors be liable for any indirect, specific, incidental or consequential damages (including damages for loss of business profits and business information, business interruption or any other pecuniary loss) arising out of the use of this manual or product, even if MikroElektronika has been advised of the possibility of such damages. MikroElektronika reserves the right to change information contained in this manual at any time without prior notice, if necessary.

HIGH RISK ACTIVITIES

The products of MikroElektronika are not fault - tolerant nor designed, manufactured or intended for use or resale as on - line control equipment in hazardous environments requiring fail - safe performance, such as in the operation of nuclear facilities, aircraft navigation or communication systems, air traffic control, direct life support machines or weapons systems in which the failure of Software could lead directly to death, personal injury or severe physical or environmental damage ('High Risk Activities'). MikroElektronika and its suppliers specifically disclaim any expressed or implied warranty of fitness for High Risk Activities.

TRADEMARKS

The MikroElektronika name and logo, mikroC™, mikroBasic™, mikroPascal™, Visual TFT™, Visual GLCD™, mikroProg™, Ready™, MINI™, mikroBUS™, EasyPIC™, EasyAVR™, Easy8051™, click™ boards and mikromedia™ are trademarks of MikroElektronika. All other trademarks mentioned herein are property of their respective companies. All other product and corporate names appearing in this manual may or may not be registered trademarks or copyrights of their respective companies, and are only used for identification or explanation and to the owners' benefit, with no intent to infringe.

Copyright © 2015 MikroElektronika. All Rights Reserved.



If you want to learn more about our products, please visit our web site at

www.mikroe.com

If you are experiencing some problems with any of our products or just need additional information, please place your ticket at **www.mikroe.com/support**

If you have any questions, comments or business proposals, do not hesitate to contact us at **office@mikroe.com**

PIC32 MX clicker manual
ver. 1.01



0100000070741



Компания «ЭлектроПласт» предлагает заключение долгосрочных отношений при поставках импортных электронных компонентов на взаимовыгодных условиях!

Наши преимущества:

- Оперативные поставки широкого спектра электронных компонентов отечественного и импортного производства напрямую от производителей и с крупнейших мировых складов;
- Поставка более 17-ти миллионов наименований электронных компонентов;
- Поставка сложных, дефицитных, либо снятых с производства позиций;
- Оперативные сроки поставки под заказ (от 5 рабочих дней);
- Экспресс доставка в любую точку России;
- Техническая поддержка проекта, помощь в подборе аналогов, поставка прототипов;
- Система менеджмента качества сертифицирована по Международному стандарту ISO 9001;
- Лицензия ФСБ на осуществление работ с использованием сведений, составляющих государственную тайну;
- Поставка специализированных компонентов (Xilinx, Altera, Analog Devices, Intersil, Interpoint, Microsemi, Aeroflex, Peregrine, Syfer, Eurofarad, Texas Instrument, Miteq, Cobham, E2V, MA-COM, Hittite, Mini-Circuits, General Dynamics и др.);

Помимо этого, одним из направлений компании «ЭлектроПласт» является направление «Источники питания». Мы предлагаем Вам помощь Конструкторского отдела:

- Подбор оптимального решения, техническое обоснование при выборе компонента;
- Подбор аналогов;
- Консультации по применению компонента;
- Поставка образцов и прототипов;
- Техническая поддержка проекта;
- Защита от снятия компонента с производства.



Как с нами связаться

Телефон: 8 (812) 309 58 32 (многоканальный)

Факс: 8 (812) 320-02-42

Электронная почта: org@eplast1.ru

Адрес: 198099, г. Санкт-Петербург, ул. Калинина, дом 2, корпус 4, литера А.