



preci-dip

WWW.PRECIDIP.COM TEL +41 32 421 04 00 SALES@PRECIDIP.COM

MALE JUMPERS

2.54 mm GRID

Available with or without insulator and with 2.54, 5.08 or 7.62 mm pitch. For use with standard socket connectors.

TECHNICAL SPECIFICATIONS (FOR GENERAL SPECS, SEE PAGE 43)

| | |
|----------------------------|--|
| INSULATOR | Black glass filled polyester PBT-GF30-FR |
| FLAMMABILITY | UL 94V-0 |
| CONTACT | Brass CuZn36Pb3 (C36000) |
| CONNECTING PIN Ø | 0.56 mm |
| MECHANICAL LIFE | Min. 100 cycles |
| RATED CURRENT | 3 A |
| CONTACT RESISTANCE | Max. 10 mΩ |
| DIELECTRIC STRENGTH | Min. 1'000 V _{RMS} |

ORDERING INFORMATION ROHS COMPLIANT PARTS

| | |
|-----------------------|--------------------|
| P PLATING CODE | TERMINATION |
| 1 | 0.25 µm gold |



See page 178 for plating spec.

Jumpers for socket connectors, B = 2.54 mm, not insulated (Fig. 1)

999-11-110-10

Jumpers for socket connectors, B = 2.54 mm (Fig. 2):

999-11-210-10

Black insulator

999-11-210-11

Red insulator

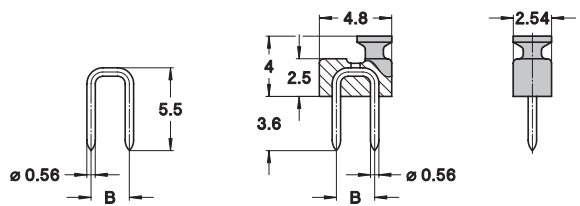

Fig. 1

Fig. 2

Jumpers for socket connectors, B = 5.08 mm, not insulated (Fig. 3)

999-11-112-10

Jumpers for socket connectors, B = 5.08 mm (Fig. 4):

999-11-220-10

Black insulator

999-11-220-11

Red insulator

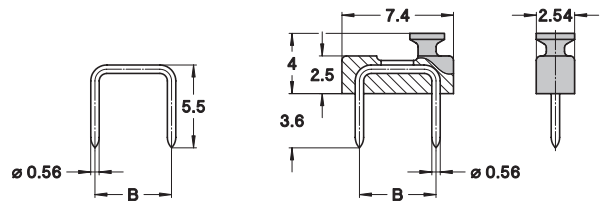

Fig. 3

Fig. 4

Jumpers for socket connectors, B = 7.62 mm, not insulated (Fig. 5)

999-11-113-10

Jumpers for socket connectors, B = 7.62 mm (Fig. 6):

999-11-230-10

Black insulator

999-11-230-11

Red insulator

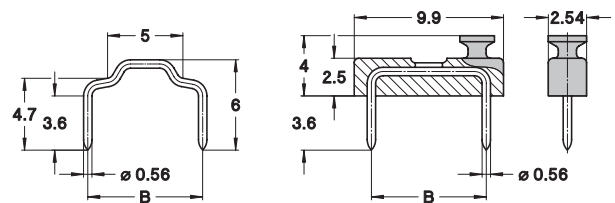

Fig. 5

Fig. 6

OPTION

Jumpers without insulator with wire Ø 0.50 mm instead of 0.56 mm.

| WIDTH B (MM) | PART NUMBER |
|--------------|---------------|
| 2.54 | 999-51-110-10 |
| 5.08 | 999-51-112-10 |
| 7.62 | 999-51-113-10 |



preci-dip

WWW.PRECIDIP.COM TEL +41 32 421 04 00 SALES@PRECIDIP.COM

FEMALE JUMPERS

2 mm / 2.54 mm GRID

Female jumpers, colour coded, closed or open top of insulator body.

TECHNICAL SPECIFICATIONS (FOR GENERAL SPECS, SEE PAGE 43)

| | |
|----------------------------|--|
| INSULATOR | Black glass filled polyester PBT-GF30-FR |
| FLAMMABILITY | UL 94V-0 |
| CONTACT | Phosphor bronze |
| MATING PIN | ∅ 0.635 mm |
| MECHANICAL LIFE | Min. 100 cycles |
| RATED CURRENT | 1 A (2 mm) / 3 A (2.54 mm) |
| CONTACT RESISTANCE | Max. 20 mΩ |
| DIELECTRIC STRENGTH | Min. 500 V _{RMS} |

ORDERING INFORMATION ROHS COMPLIANT PARTS

| | |
|------------------------|--------------------|
| PP PLATING CODE | TERMINATION |
| 19 | Flash gold |



See page 178 for plating specs.

PCB CONNECTORS

2 mm jumpers for ∅ 0.5 mm pin headers, closed body:

999-19-220-00

Black insulator

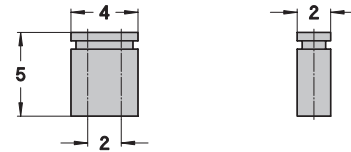

2 mm jumpers for ∅ 0.5 mm pin headers, stackable open body:

999-19-320-00

Black insulator

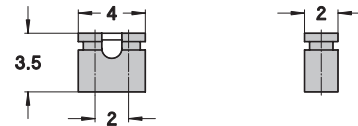

2.54 mm jumpers for ∅ 0.635 mm pin headers, closed body:

999-19-210-00

Black insulator

999-19-210-02

Red insulator

999-19-210-06

Blue insulator

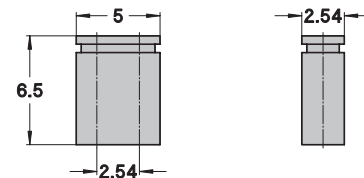

2.54 mm jumpers for ∅ 0.635 mm pin headers, stackable open body:

999-19-310-00

Black insulator

999-19-310-02

Red insulator

999-19-310-06

Blue insulator

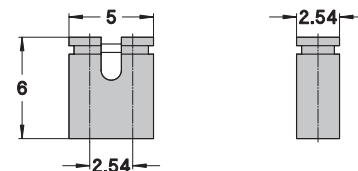

DIL SOCKETS

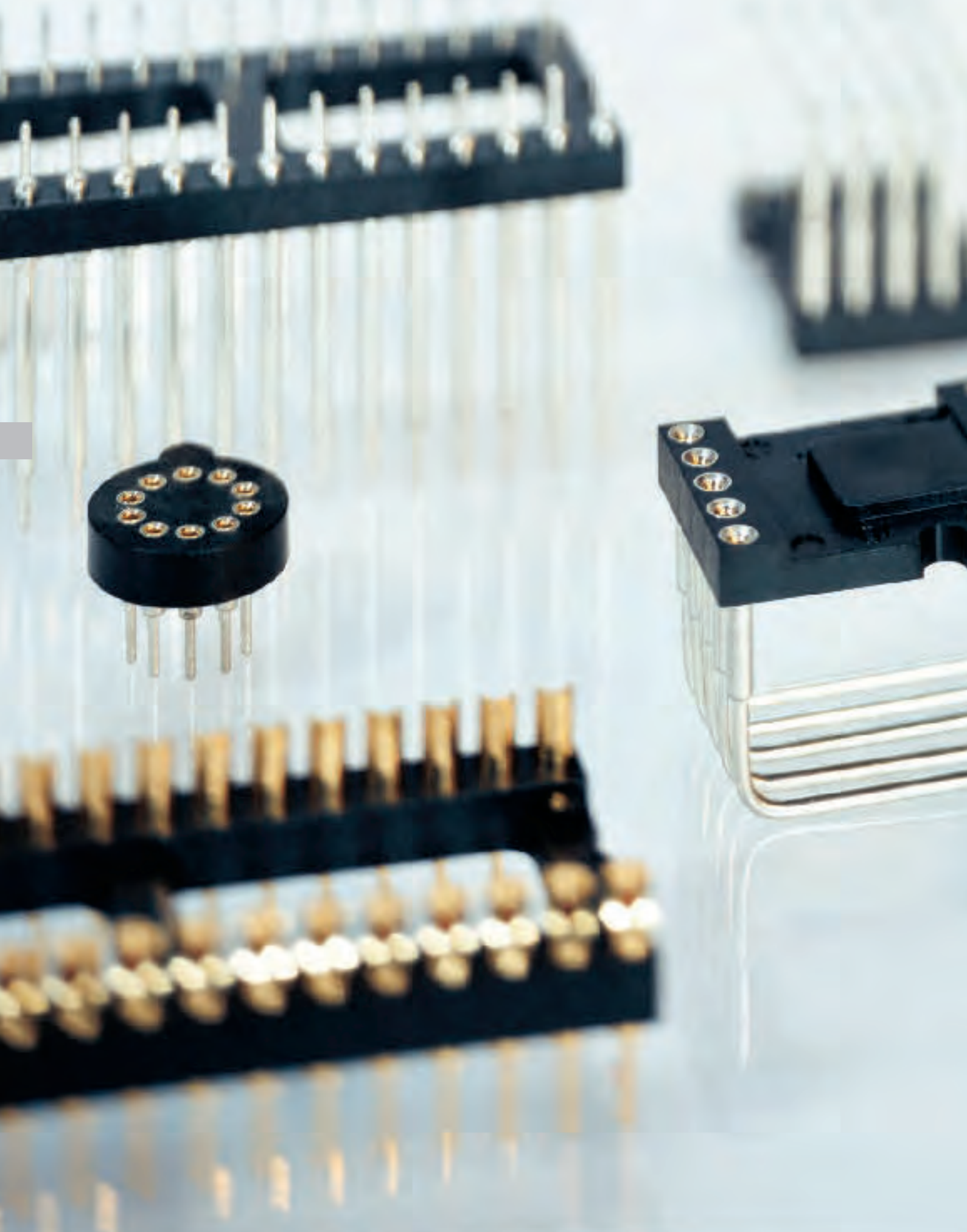

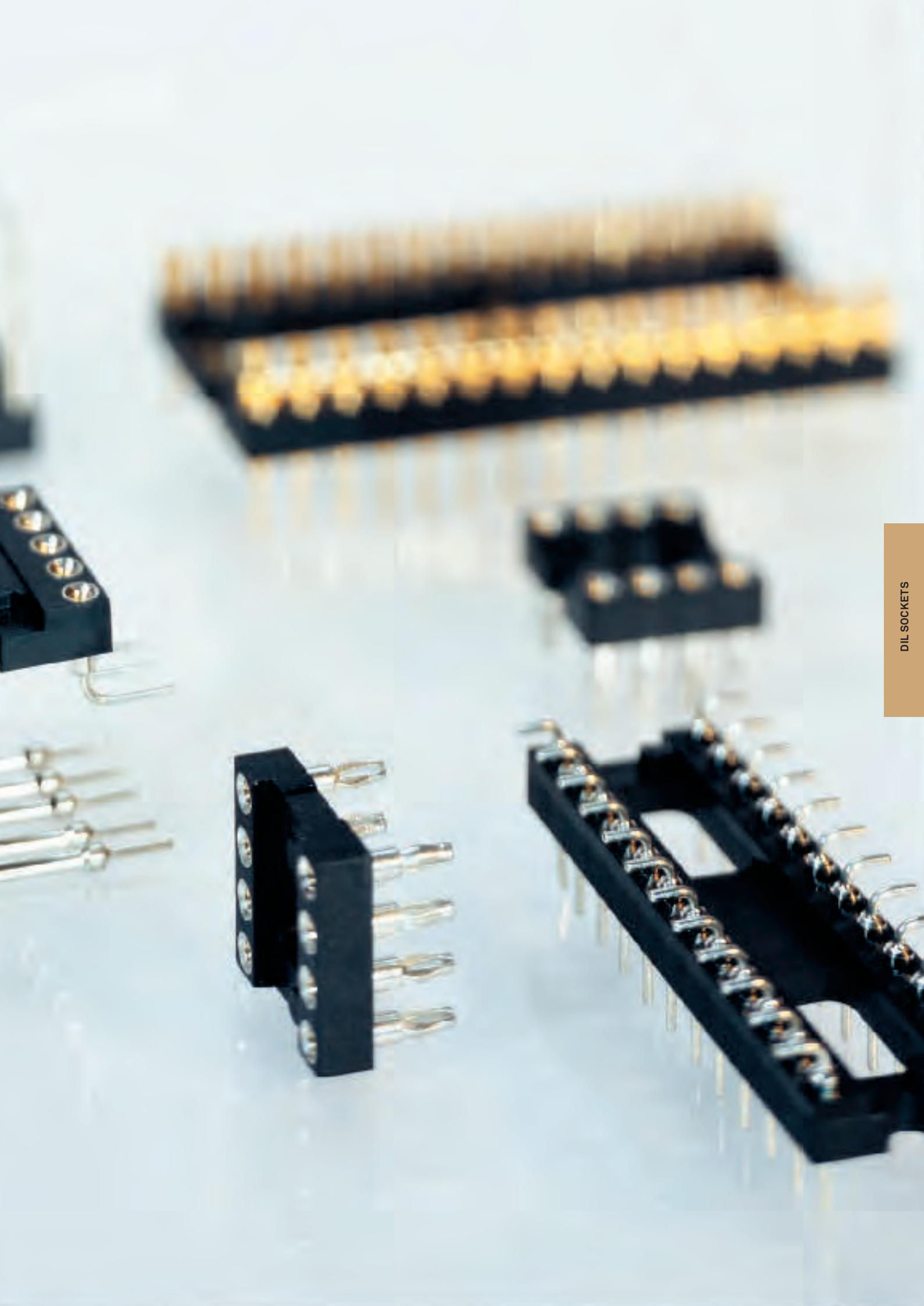



preci-dip

WWW.PRECIDIP.COM TEL +41 32 421 04 00 SALES@PRECIDIP.COM

QUICK SELECTOR CHART

DIL / SIL / TO SOCKETS

| GRID | | DIL | | STAGGERED | STAGGERED | TO |
|--|--|-----------------|----------|-----------|-----------|-----|
| | | 2.54 mm | 1.778 mm | 2.54 mm | 2.54 mm | |
| SOCKETS | | SEE PAGE | | | | |
| Solder tail | | 129 | 141 | 150 | 150 | 149 |
| Solder tail automatic insertion | | 130 | | | | |
| Solder tail with decoupling capacitor | | 131 | | | | |
| Surface mount | | 132, 134 | 141 | | | |
| Surface mount pick and place | | 133, 135 | | | | 149 |
| Solder tail ultralow profile | | 137 | | | | |
| Solder tail interconnect | | 138 | | | | |
| Wire-wrap | | 139 | | | | |
| Solderless press-fit mount | | 142 | | | | |
| Carrier | | 143 | | | | |
| Display right angle solder tail | | 144 | | | | |
| Crystal, relay and display, partially equipped solder tail | | 151 | | | | |
| HEADERS | | | | | | |
| Solder tail | | 145 | 141 | | | |
| Solder tail interconnect | | 145 | | | | |
| Surface mount | | 146 | | | | |
| Surface mount pick and place | | 147 | | | | |
| Solder tail wiring slotted head | | 148 | | | | |
| Solder tail wiring turret head | | 148 | | | | |
| Solder tail wiring solder cup | | 148 | | | | |



preci-dip

WWW.PRECIDIP.COM TEL +41 32 421 04 00 SALES@PRECIDIP.COM

DIL SOCKETS

GENERAL SPECIFICATIONS

The values listed below are general specs applying for PRECI-DIP DIL sockets. Please see individual catalog page for additional and product specific technical data.

| | |
|------------------------------------|------------------|
| OPERATING TEMPERATURE RANGE | -55 ... +125 °C |
| CLIMATIC CATEGORY (IEC) | 55/125/21 |
| OPERATING HUMIDITY RANGE | Annual mean 75% |
| MAX. WORKING VOLTAGE | 100 VRMS/150 VDC |



PRECI-DIP connectors designated «Series Preci-Dip Connector» are recognized by UL LLC and listed under «Connectors for Use in Data, Signal, Control and Power Applications», File Nr. E174442.

MECHANICAL CHARACTERISTICS

| | |
|--|---|
| CLIP RETENTION | Min. 40 N (no displacement under axial force applied) |
| CONTACT (SLEEVE / CLIP) RETENTION | Min. 3.3 N acc. to MIL-DTL-83734, pt 4.6.4.2 |

ELECTRICAL CHARACTERISTICS

| | |
|--|----------------|
| INSULATION RESISTANCE AT 500 V AC BETWEEN ANY TWO ADJACENT CONTACTS | Min. 10'000 MΩ |
| CAPACITANCE BETWEEN ANY TWO ADJACENT CONTACTS | Max. 1 pF |
| AIR AND CREEPAGE DISTANCES BETWEEN ANY TWO ADJACENT CONTACTS (Min. 0.2 mm FOR SHRINK-DIP SOCKETS) | Min. 0.6 mm |

ENVIRONMENTAL CHARACTERISTICS

The sockets withstand the following environmental tests without mechanical and electrical defects:

- Dry heat steady state IEC 60512-11-9.11i / 60068-2-2.Bb: 125 °C, 16 h
 - Damp heat cyclic IEC 60512-11-12.11m / 60068-2-30.Db: 25/55 °C, 90 – 100 %rH, 1 cycle of 24 h
 - Cold steady state IEC 60512-11-10.11j / 60068-2-1.A: -55 °C, 2 h
 - Thermal shock IEC 60512-11-4.11d / 60068-2-14.Na: -55/125 °C, 5 cycles 30 min.
 - Sinusoidal vibrations IEC 60512-6-4.6d / 60068-2-6.Fc: 10 to 500 Hz, 10 g, 1 octave/min, 10 cycles for each axis
 - Shock IEC 60512-6-3.6c / 60068-2-27.Ea: 50 g, 11 ms, 3 shocks in three axis
- During the above two tests, no contact interruption >50 ns does appear.

- Solderability J-STD-002A, Test A, 245 °C, 5 s, solder alloy SnAg3.8Cu0.7
- Resistance to soldering heat J-STD-020C, 260 °C, 20 s
- Moisture sensitivity J-STD-020C level 1
- Resistance to corrosion:
 - 1) Salt spray test IEC 60068-2-11.Ka: 48 h
 - 2) Sulfur dioxide (SO₂) test IEC 60068-2-42 Kc: 96 h at 25 ppm SO₂, 25 °C, 75 %rH
 - 3) Hydrogen sulfide (H₂S) test IEC 60068-2-43 Kd: 96 h at 12 ppm H₂S, 25 °C, 75 %rH

SOLDERLESS COMPLIANT PRESS-FIT CHARACTERISTICS

PRESS-FIT CHARACTERISTICS MEASURED ACC. TO IEC 60352-5

- Press-in force: 90 N max. (at min. hole dia.) / 65 N typ.
- Push-out force: 30 N min. (at max. hole dia.) / 50 N typ.
- Push-out 3rd cycle: 20 N min. (at max. hole dia.)

PCB HOLE DIMENSIONS

- 2.54 mm grid
Finished hole Ø: 1 + 0.09/-0.06 mm
Drilled hole Ø: 1.15 ± 0.025 mm

PCB HOLE PLATING

- PCB surface finish
Hole plating
- Tin: 5-15 µm tin over min. 25 µm copper
- Copper: min. 25 µm copper
- Gold over nickel: 0.05-0.2 µm gold over 2.5-5 µm nickel over min. 25 µm copper

PACKAGING

- Standard packaging for DIL sockets is tube packaging.
- SMD mount sockets available on request with Tape & Reel packaging acc. to EIA Standard 481. These products are marked with the symbol:

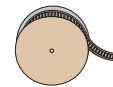

T & R Packaging

Please consult www.precidip.com for availability, size of tape, size of reel, number of components per reel, packing units and part numbers.



preci-dip

WWW.PRECIDIP.COM TEL +41 32 421 04 00 SALES@PRECIDIP.COM

DUAL-IN-LINE SOCKETS

INSULATOR BODIES / STANDARD, OPEN FRAME

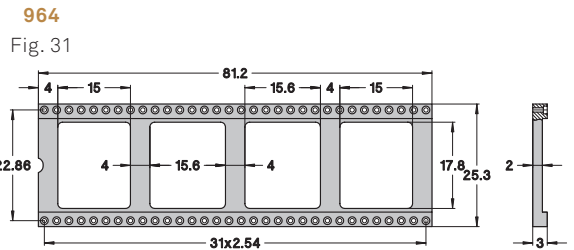
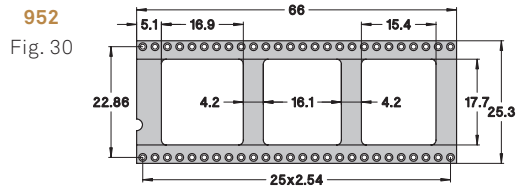
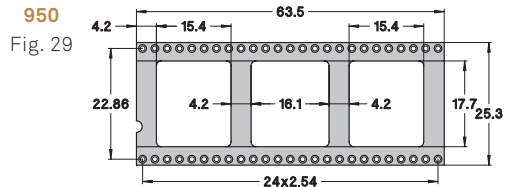
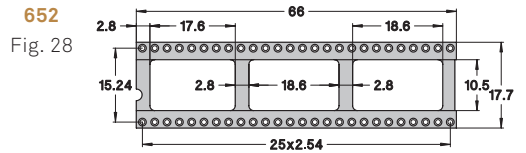
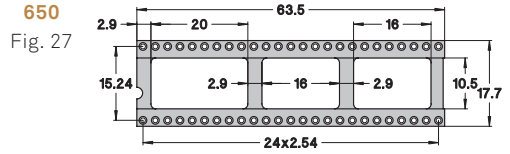
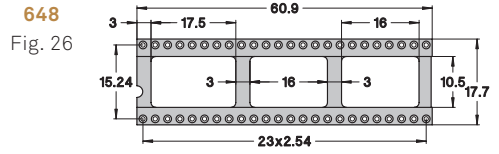
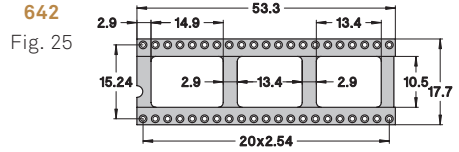
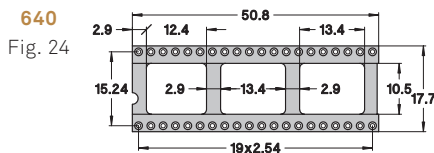
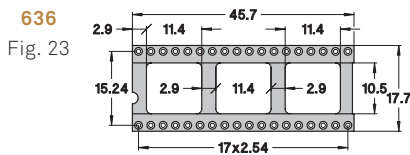
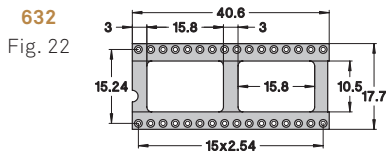
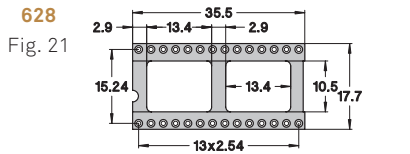
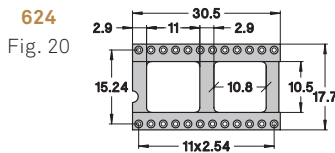
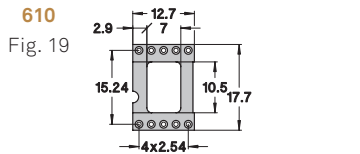
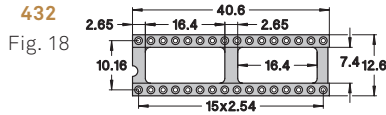
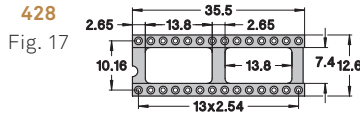
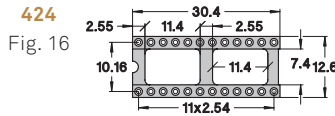
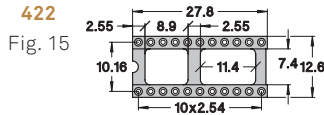
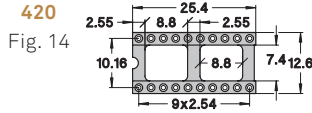
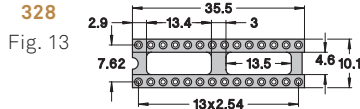
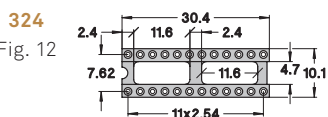
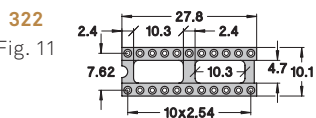
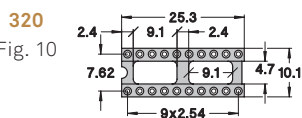
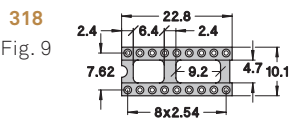
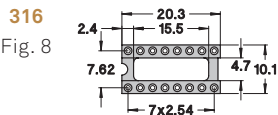
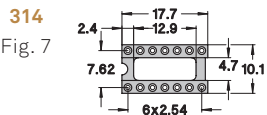
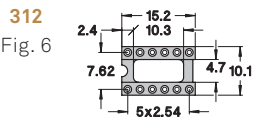
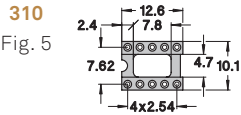
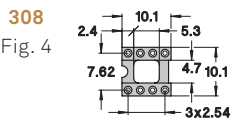
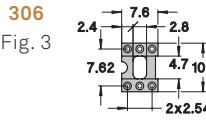
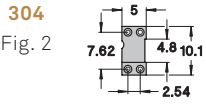
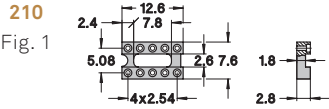

ORDERING INFORMATION

Example:

110-PP-**314**-41-001101 (Order Code)

Row spacing
Number of pins

314
Fig. 7

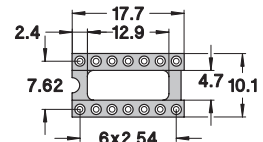



preci-dip

WWW.PRECIDIP.COM TEL +41 32 421 04 00 SALES@PRECIDIP.COM

DUAL-IN-LINE SOCKETS

OPEN FRAME / SOLDER TAIL

Open frame standard low profile DIL Sockets.

TECHNICAL SPECIFICATIONS (FOR GENERAL SPECS, SEE PAGE 127)

| | |
|--------------------------------|---|
| INSULATOR | Black glass filled polyester PCT-GF30-FR |
| FLAMMABILITY | UL 94V-0 |
| SLEEVE | Brass CuZn36Pb3 (C36000) |
| CONTACT CLIP (4 FINGER) | Beryllium copper (C17200) |
| ACCEPTED PIN Ø | 0.40 to 0.56 mm |
| FORCES | 2 N typ. insertion 1 N typ. withdrawal (polished steel gauge Ø 0.43 mm) |
| MECHANICAL LIFE | Min. 100 cycles |
| RATED CURRENT | 1 A |
| CONTACT RESISTANCE | Max. 10 mΩ |
| DIELECTRIC STRENGTH | Min. 1'000 VRMS |



ORDERING INFORMATION ROHS COMPLIANT PARTS

| | | |
|------------------------|---------------|--------------|
| PP PLATING CODE | SLEEVE | CLIP |
| 87 | Tin | Flash gold |
| 83 | Tin | 0.75 µm gold |

Other plating on request (see page 178 for plating specs).

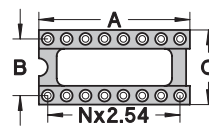
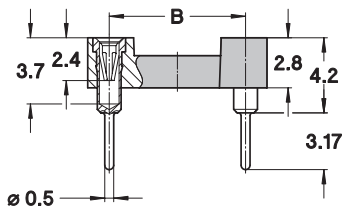

| NO. OF POLES | A | B | C | SEE PAGE 128 | ORDER CODES |
|--------------|------|-------|------|--------------|----------------------|
| 10 | 12.6 | 5.08 | 7.6 | Fig. 1 | 110-PP-210-41-001101 |
| 4 | 5.0 | 7.62 | 10.1 | Fig. 2 | 110-PP-304-41-001101 |
| 6 | 7.6 | 7.62 | 10.1 | Fig. 3 | 110-PP-306-41-001101 |
| 8 | 10.1 | 7.62 | 10.1 | Fig. 4 | 110-PP-308-41-001101 |
| 10 | 12.6 | 7.62 | 10.1 | Fig. 5 | 110-PP-310-41-001101 |
| 12 | 15.2 | 7.62 | 10.1 | Fig. 6 | 110-PP-312-41-001101 |
| 14 | 17.7 | 7.62 | 10.1 | Fig. 7 | 110-PP-314-41-001101 |
| 16 | 20.3 | 7.62 | 10.1 | Fig. 8 | 110-PP-316-41-001101 |
| 18* | 22.8 | 7.62 | 10.1 | Fig. 9 | 110-PP-318-41-001101 |
| 20* | 25.3 | 7.62 | 10.1 | Fig. 10 | 110-PP-320-41-001101 |
| 22* | 27.8 | 7.62 | 10.1 | Fig. 11 | 110-PP-322-41-001101 |
| 24* | 30.4 | 7.62 | 10.1 | Fig. 12 | 110-PP-324-41-001101 |
| 28 | 35.5 | 7.62 | 10.1 | Fig. 13 | 110-PP-328-41-001101 |
| 20 | 25.4 | 10.16 | 12.6 | Fig. 14 | 110-PP-420-41-001101 |
| 22 | 27.8 | 10.16 | 12.6 | Fig. 15 | 110-PP-422-41-001101 |
| 24 | 30.4 | 10.16 | 12.6 | Fig. 16 | 110-PP-424-41-001101 |
| 28 | 35.5 | 10.16 | 12.6 | Fig. 17 | 110-PP-428-41-001101 |
| 32 | 40.6 | 10.16 | 12.6 | Fig. 18 | 110-PP-432-41-001101 |
| 10 | 12.7 | 15.24 | 17.7 | Fig. 19 | 110-PP-610-41-001101 |
| 24* | 30.5 | 15.24 | 17.7 | Fig. 20 | 110-PP-624-41-001101 |
| 28* | 35.5 | 15.24 | 17.7 | Fig. 21 | 110-PP-628-41-001101 |
| 32* | 40.6 | 15.24 | 17.7 | Fig. 22 | 110-PP-632-41-001101 |
| 36 | 45.7 | 15.24 | 17.7 | Fig. 23 | 110-PP-636-41-001101 |
| 40* | 50.8 | 15.24 | 17.7 | Fig. 24 | 110-PP-640-41-001101 |
| 42 | 53.3 | 15.24 | 17.7 | Fig. 25 | 110-PP-642-41-001101 |
| 48* | 60.9 | 15.24 | 17.7 | Fig. 26 | 110-PP-648-41-001101 |
| 50 | 63.5 | 15.24 | 17.7 | Fig. 27 | 110-PP-650-41-001101 |
| 52 | 66.0 | 15.24 | 17.7 | Fig. 28 | 110-PP-652-41-001101 |
| 50 | 63.5 | 22.86 | 25.3 | Fig. 29 | 110-PP-950-41-001101 |
| 52 | 66.0 | 22.86 | 25.3 | Fig. 30 | 110-PP-952-41-001101 |
| 64 | 81.2 | 22.86 | 25.3 | Fig. 31 | 110-PP-964-41-001101 |

OPTIONS

- 1 **Insulators without center bar ***
Open frame insulators 318, 320, 322, 324, 624, 628, 632, 640 and 648 available on special request without center bars; add suffix 151 to the part number. Example 110-83-628-41-001101 becomes 110-83-628-41-001151
- 2 **Sockets with increased solder tail length of 4.2 mm**
allowing application on multilayer PCBs up to 3.4 mm thickness replace 110-...-...-... by 111-...-...-...
- 3 **Sockets with soft brass pin series 110-...-...-005101**, please consult
- 4 **For DIL Sockets with closed frame insulators** replace 110-... by 210-... Please consult for available pin numbers



preci-dip

WWW.PRECIDIP.COM TEL +41 32 421 04 00 SALES@PRECIDIP.COM

DUAL-IN-LINE SOCKETS

AUTOMATIC INSERTION / OPEN FRAME / SOLDER TAIL

DIL sockets with ribbed insulator body and soft copper alloy contacts compatible with automatic insertion equipment.

TECHNICAL SPECIFICATIONS (FOR GENERAL SPECS, SEE PAGE 127)

| | |
|-------------------------|---|
| INSULATOR | Black glass filled polyester PCT-GF30-FR |
| FLAMMABILITY | UL 94V-0 |
| SLEEVE | Brass CuZn36Pb3 (C36000) |
| CONTACT CLIP (4 FINGER) | Beryllium copper (C17200) |
| ACCEPTED PIN Ø | 0.40 to 0.56 mm |
| FORCES | 2 N typ. insertion 1 N typ. withdrawal (polished steel gauge Ø 0.43 mm) |
| MECHANICAL LIFE | Min. 100 cycles |
| RATED CURRENT | 1 A |
| CONTACT RESISTANCE | Max. 10 mΩ |
| DIELECTRIC STRENGTH | Min. 1'000 V _{RMS} |



ORDERING INFORMATION ROHS COMPLIANT PARTS

| | | |
|-----------------|--------|--------------|
| PP PLATING CODE | SLEEVE | CLIP |
| 87 | Tin | Flash gold |
| 83 | Tin | 0.75 µm gold |

Other plating on request (see page 178 for plating specs).
Other pin count please consult.

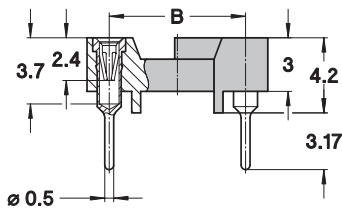

| NO. OF POLES | B | SEE BELOW | ORDER CODES |
|--------------|-------|-----------|----------------------|
| 6 | 7.62 | Fig. 1 | 110-PP-306-41-605101 |
| 8 | 7.62 | Fig. 2 | 110-PP-308-41-605101 |
| 14 | 7.62 | Fig. 3 | 110-PP-314-41-605101 |
| 16 | 7.62 | Fig. 4 | 110-PP-316-41-605101 |
| 18 | 7.62 | Fig. 5 | 110-PP-318-41-605101 |
| 20 | 7.62 | Fig. 6 | 110-PP-320-41-605101 |
| 24 | 7.62 | Fig. 7 | 110-PP-324-41-605101 |
| 28 | 7.62 | Fig. 7a | 110-PP-328-41-605101 |
| 22 | 10.16 | Fig. 8 | 110-PP-422-41-605101 |
| 24 | 15.24 | Fig. 9 | 110-PP-624-41-605101 |
| 28 | 15.24 | Fig. 10 | 110-PP-628-41-605101 |
| 32 | 15.24 | Fig. 11 | 110-PP-632-41-605101 |
| 40 | 15.24 | Fig. 12 | 110-PP-640-41-605101 |

INSULATOR BODIES

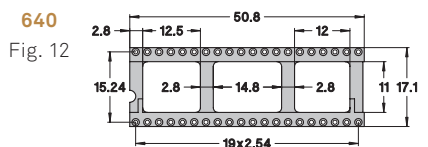
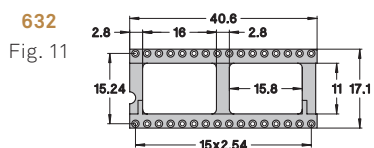
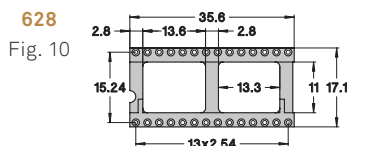
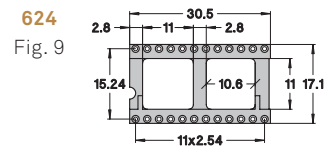
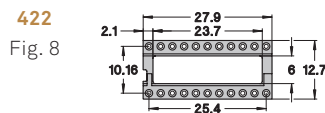
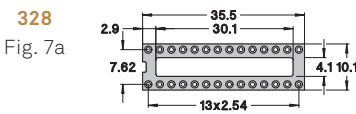
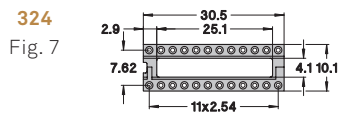
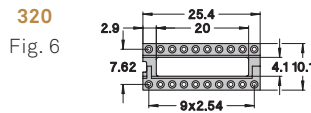
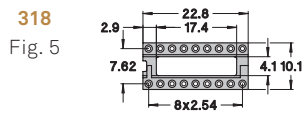
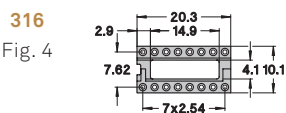
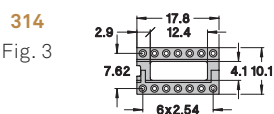
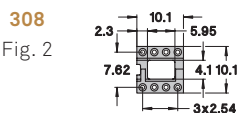
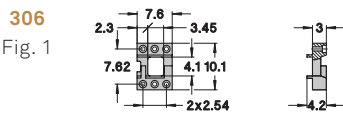



preci-dip

WWW.PRECIDIP.COM TEL +41 32 421 04 00 SALES@PRECIDIP.COM

DUAL-IN-LINE CAPACITOR SOCKETS

OPEN FRAME / SOLDER TAIL

With ceramic multilayer decoupling capacitor 100 nF +80% -20% / 50 V, epoxy encapsulated.

TECHNICAL SPECIFICATIONS (FOR GENERAL SPECS, SEE PAGE 127)

| | |
|--------------------------------|---|
| INSULATOR | Black glass filled polyester PCT-GF30-FR |
| FLAMMABILITY | UL 94V-0 |
| SLEEVE | Brass CuZn36Pb3 (C36000) |
| CONTACT CLIP (4 FINGER) | Beryllium copper (C17200) |
| ACCEPTED PIN Ø | 0.40 to 0.56 mm |
| FORCES | 2 N typ. insertion 1 N typ. withdrawal (polished steel gauge Ø 0.43 mm) |
| MECHANICAL LIFE | Min. 100 cycles |
| RATED CURRENT | 1 A |
| CONTACT RESISTANCE | Max. 10 mΩ |
| DIELECTRIC STRENGTH | Min. 1'000 V _{RMS} |
| TEMPERATURE RANGE | -25°C to +85°C |

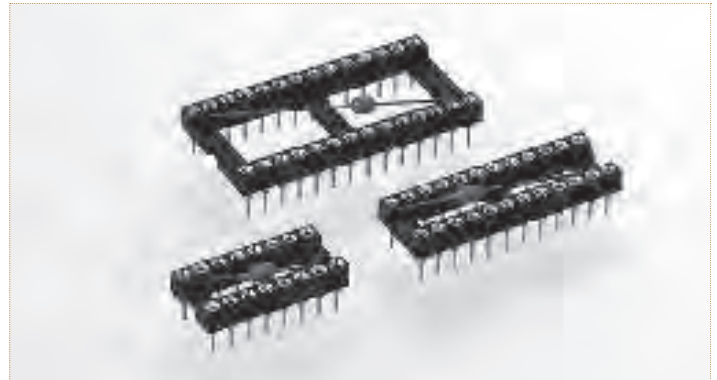

ORDERING INFORMATION ROHS COMPLIANT PARTS

| | | |
|------------------------|---------------|--------------|
| PP PLATING CODE | SLEEVE | CLIP |
| 83 | Tin | 0.75 µm gold |

Other plating on request (see page 178 for plating specs).

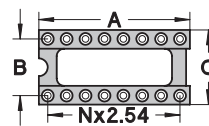
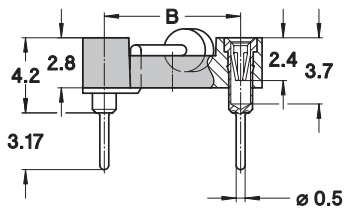

| NO. OF POLES | A | B | C | SEE PAGE 128 | ORDER CODES |
|--------------|------|-------|------|--------------|----------------------|
| 14 | 17.7 | 7.62 | 10.1 | Fig. 7 | 110-PP-314-41-801101 |
| 16 | 20.3 | 7.62 | 10.1 | Fig. 8 | 110-PP-316-41-801101 |
| 18 | 22.8 | 7.62 | 10.1 | Fig. 9 | 110-PP-318-41-801101 |
| 20 | 25.3 | 7.62 | 10.1 | Fig. 10 | 110-PP-320-41-801101 |
| 24 | 30.5 | 15.24 | 17.7 | Fig. 20 | 110-PP-624-41-801101 |
| 28 | 35.5 | 15.24 | 17.7 | Fig. 21 | 110-PP-628-41-801101 |
| 32 | 40.6 | 15.24 | 17.7 | Fig. 22 | 110-PP-632-41-801101 |
| 40 | 50.8 | 15.24 | 17.7 | Fig. 24 | 110-PP-640-41-801101 |

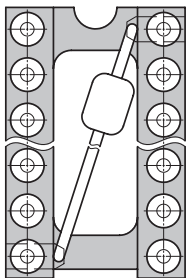



preci-dip

WWW.PRECIDIP.COM TEL +41 32 421 04 00 SALES@PRECIDIP.COM

DUAL-IN-LINE SOCKETS

OPEN FRAME / SURFACE MOUNT

Specially designed for reflow soldering including vapor phase with gull wing terminations for maximum strength and easy in-circuit test.

TECHNICAL SPECIFICATIONS (FOR GENERAL SPECS, SEE PAGE 127)

| | |
|--------------------------------|---|
| INSULATOR | Black glass filled polyester PCT-GF30-FR |
| FLAMMABILITY | UL 94V-0 |
| SLEEVE | Brass CuZn36Pb3 (C36000) |
| CONTACT CLIP (4 FINGER) | Beryllium copper (C17200) |
| ACCEPTED PIN Ø | 0.40 to 0.56 mm |
| FORCES | 2 N typ. insertion 1 N typ. withdrawal (polished steel gauge Ø 0.43 mm) |
| MECHANICAL LIFE | Min. 100 cycles |
| RATED CURRENT | 1 A |
| CONTACT RESISTANCE | Max. 10 mΩ |
| DIELECTRIC STRENGTH | Min. 1'000 V _{RMS} |
| COPLANARITY | |
| SMD TERMINATIONS | Max. 0.10 mm |



ORDERING INFORMATION ROHS COMPLIANT PARTS

| PP PLATING CODE | SLEEVE | CLIP |
|-----------------|--------|--------------|
| 87 | Tin | Flash gold |
| 83 | Tin | 0.75 µm gold |

Other plating on request (see page 178 for plating specs).

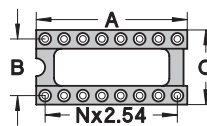
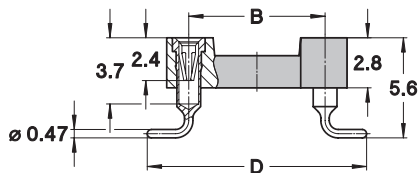

| NO. OF POLES | A | B | C | D | SEE PAGE 128 | ORDER CODES |
|--------------|------|-------|------|-------|--------------|----------------------|
| 10 | 12.6 | 5.08 | 7.6 | 9.72 | Fig. 1 | 110-PP-210-41-105101 |
| 4 | 5.0 | 7.62 | 10.1 | 12.26 | Fig. 2 | 110-PP-304-41-105101 |
| 6 | 7.6 | 7.62 | 10.1 | 12.26 | Fig. 3 | 110-PP-306-41-105101 |
| 8 | 10.1 | 7.62 | 10.1 | 12.26 | Fig. 4 | 110-PP-308-41-105101 |
| 10 | 12.6 | 7.62 | 10.1 | 12.26 | Fig. 5 | 110-PP-310-41-105101 |
| 12 | 15.2 | 7.62 | 10.1 | 12.26 | Fig. 6 | 110-PP-312-41-105101 |
| 14 | 17.7 | 7.62 | 10.1 | 12.26 | Fig. 7 | 110-PP-314-41-105101 |
| 16 | 20.3 | 7.62 | 10.1 | 12.26 | Fig. 8 | 110-PP-316-41-105101 |
| 18 | 22.8 | 7.62 | 10.1 | 12.26 | Fig. 9 | 110-PP-318-41-105101 |
| 20 | 25.3 | 7.62 | 10.1 | 12.26 | Fig. 10 | 110-PP-320-41-105101 |
| 22 | 27.8 | 7.62 | 10.1 | 12.26 | Fig. 11 | 110-PP-322-41-105101 |
| 24 | 30.4 | 7.62 | 10.1 | 12.26 | Fig. 12 | 110-PP-324-41-105101 |
| 28 | 35.5 | 7.62 | 10.1 | 12.26 | Fig. 13 | 110-PP-328-41-105101 |
| 20 | 25.4 | 10.16 | 12.6 | 14.80 | Fig. 14 | 110-PP-420-41-105101 |
| 22 | 27.8 | 10.16 | 12.6 | 14.80 | Fig. 15 | 110-PP-422-41-105101 |
| 24 | 30.4 | 10.16 | 12.6 | 14.80 | Fig. 16 | 110-PP-424-41-105101 |
| 28 | 35.5 | 10.16 | 12.6 | 14.80 | Fig. 17 | 110-PP-428-41-105101 |
| 32 | 40.6 | 10.16 | 12.6 | 14.80 | Fig. 18 | 110-PP-432-41-105101 |
| 24 | 30.5 | 15.24 | 17.7 | 19.88 | Fig. 20 | 110-PP-624-41-105101 |
| 28 | 35.5 | 15.24 | 17.7 | 19.88 | Fig. 21 | 110-PP-628-41-105101 |
| 32 | 40.6 | 15.24 | 17.7 | 19.88 | Fig. 22 | 110-PP-632-41-105101 |
| 36 | 45.7 | 15.24 | 17.7 | 19.88 | Fig. 23 | 110-PP-636-41-105101 |
| 40 | 50.8 | 15.24 | 17.7 | 19.88 | Fig. 24 | 110-PP-640-41-105101 |
| 42 | 53.3 | 15.24 | 17.7 | 19.88 | Fig. 25 | 110-PP-642-41-105101 |
| 48 | 60.9 | 15.24 | 17.7 | 19.88 | Fig. 26 | 110-PP-648-41-105101 |

PCB LAYOUT

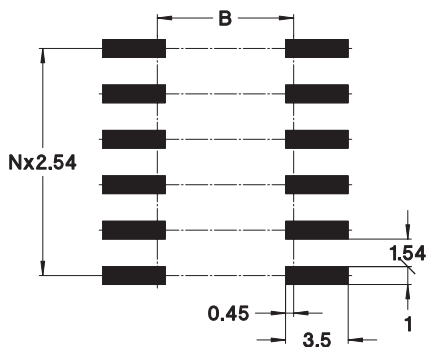



preci-dip

WWW.PRECIDIP.COM TEL +41 32 421 04 00 SALES@PRECIDIP.COM

DUAL-IN-LINE SOCKETS

OPEN FRAME / SURFACE MOUNT, PICK AND PLACE

Specially designed for reflow soldering including vapor phase with gull wing terminations for maximum strength and easy in-circuit test.

TECHNICAL SPECIFICATIONS (FOR GENERAL SPECS, SEE PAGE 127)

| | | |
|--------------------------------|--|---|
| INSULATOR | Black glass filled polyester PCT-GF30-FR | |
| FLAMMABILITY | UL 94V-0 | |
| SLEEVE | Brass CuZn36Pb3 (C36000) | |
| CONTACT CLIP (4 FINGER) | Beryllium copper (C17200) | |
| ACCEPTED PIN Ø | 0.40 to 0.56 mm | |
| FORCES | 2 N typ. insertion | 1 N typ. withdrawal (polished steel gauge Ø 0.43 mm) |
| MECHANICAL LIFE | Min. 100 cycles | |
| RATED CURRENT | 1 A | |
| CONTACT RESISTANCE | Max. 10 mΩ | |
| DIELECTRIC STRENGTH | Min. 1'000 V _{RMS} | |
| COPLANARITY | Max. 0.10 mm | |
| SMD TERMINATIONS | | |

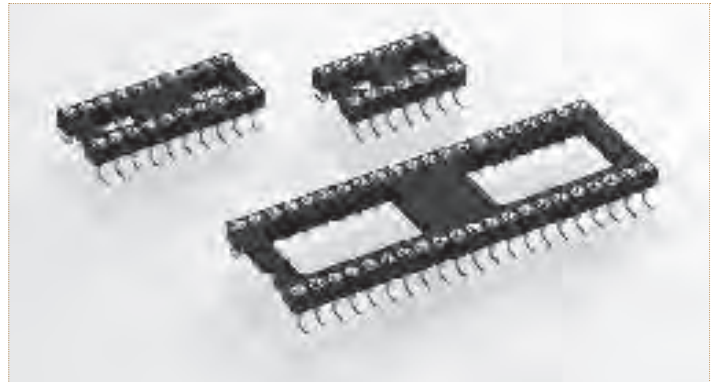

ORDERING INFORMATION ROHS COMPLIANT PARTS

| PP PLATING CODE | SLEEVE | CLIP |
|-----------------|--------|--------------|
| 87 | Tin | Flash gold |
| 83 | Tin | 0.75 µm gold |

Other plating on request (see page 178 for plating specs).

Tape & Reel packaging:

replace 161 by suffix 191 to part number
Other pin counts please consult.



T & R Packaging

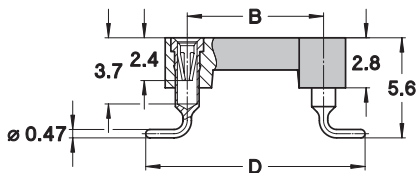

| NO. OF POLES | A | B | C | D | E | ORDER CODES |
|--------------|------|-------|------|-------|------|----------------------|
| 6 | 7.6 | 7.62 | 10.1 | 12.26 | 7.6 | 110-PP-306-41-105161 |
| 8 | 10.1 | 7.62 | 10.1 | 12.26 | 10.1 | 110-PP-308-41-105161 |
| 10 | 12.6 | 7.62 | 10.1 | 12.26 | 12.6 | 110-PP-310-41-105161 |
| 14 | 17.8 | 7.62 | 10.1 | 12.26 | 5.3 | 110-PP-314-41-105161 |
| 16 | 20.3 | 7.62 | 10.1 | 12.26 | 5.3 | 110-PP-316-41-105161 |
| 18 | 22.9 | 7.62 | 10.1 | 12.26 | 5.3 | 110-PP-318-41-105161 |
| 20 | 25.4 | 7.62 | 10.1 | 12.26 | 8.3 | 110-PP-320-41-105161 |
| 24 | 30.4 | 7.62 | 10.1 | 12.26 | 8.3 | 110-PP-324-41-105161 |
| 28 | 35.6 | 7.62 | 10.1 | 12.26 | 8.3 | 110-PP-328-41-105161 |
| 28 | 35.5 | 15.24 | 17.7 | 19.88 | 10.0 | 110-PP-628-41-105161 |
| 32 | 40.6 | 15.24 | 17.7 | 19.88 | 10.0 | 110-PP-632-41-105161 |
| 40 | 50.8 | 15.24 | 17.7 | 19.88 | 10.0 | 110-PP-640-41-105161 |
| 42 | 53.4 | 15.24 | 17.7 | 19.88 | 10.0 | 110-PP-642-41-105161 |

DIL SOCKETS

INSULATOR

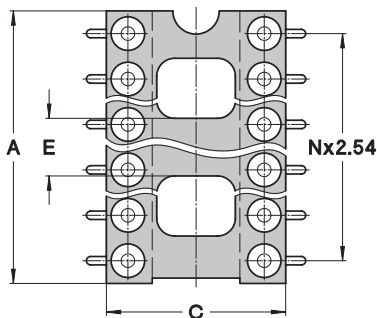

PCB LAYOUT

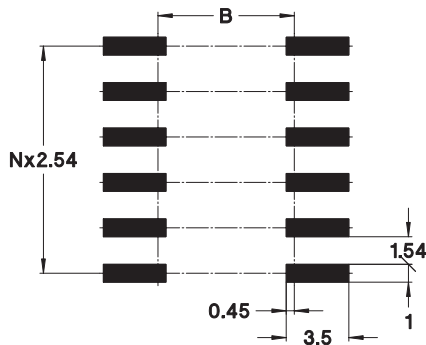



preci-dip

WWW.PRECIDIP.COM TEL +41 32 421 04 00 SALES@PRECIDIP.COM

DUAL-IN-LINE SOCKETS

OPEN FRAME / SURFACE MOUNT

Specially designed for reflow soldering including vapor phase with unique self-aligning floating contacts.

TECHNICAL SPECIFICATIONS (FOR GENERAL SPECS, SEE PAGE 127)

| | |
|-------------------------|--|
| INSULATOR | Black glass filled polyester PCT-GF30-FR |
| FLAMMABILITY | UL 94V-0 |
| SLEEVE | Brass CuZn36Pb3 (C36000) |
| CONTACT CLIP (4 FINGER) | Beryllium copper (C17200) |
| ACCEPTED PIN Ø | 0.40 to 0.56 mm |
| FORCES | 2 N typ. insertion 1 N typ. withdrawal (polished steel gauge Ø 0.43 mm) |
| MECHANICAL LIFE | Min. 100 cycles |
| RATED CURRENT | 1 A |
| CONTACT RESISTANCE | Max. 10 mΩ |
| DIELECTRIC STRENGTH | Min. 1'000 V _{RMS} |
| COPLANARITY | |
| SMD TERMINATIONS | Max. 0.10 mm |



ORDERING INFORMATION ROHS COMPLIANT PARTS

| PP PLATING CODE | SLEEVE | CLIP |
|-----------------|--------|--------------|
| 87 | Tin | Flash gold |
| 83 | Tin | 0.75 µm gold |

Other plating on request (see page 178 for plating specs).

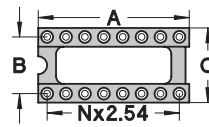
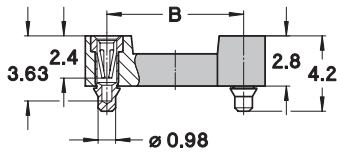

| NO. OF POLES | A | B | C | SEE PAGE 128 | ORDER CODES |
|--------------|------|-------|------|--------------|----------------------|
| 10 | 12.6 | 5.08 | 7.6 | Fig. 1 | 114-PP-210-41-117101 |
| 4 | 5.0 | 7.62 | 10.1 | Fig. 2 | 114-PP-304-41-117101 |
| 6 | 7.6 | 7.62 | 10.1 | Fig. 3 | 114-PP-306-41-117101 |
| 8 | 10.1 | 7.62 | 10.1 | Fig. 4 | 114-PP-308-41-117101 |
| 10 | 12.6 | 7.62 | 10.1 | Fig. 5 | 114-PP-310-41-117101 |
| 12 | 15.2 | 7.62 | 10.1 | Fig. 6 | 114-PP-312-41-117101 |
| 14 | 17.7 | 7.62 | 10.1 | Fig. 7 | 114-PP-314-41-117101 |
| 16 | 20.3 | 7.62 | 10.1 | Fig. 8 | 114-PP-316-41-117101 |
| 18 | 22.8 | 7.62 | 10.1 | Fig. 9 | 114-PP-318-41-117101 |
| 20 | 25.3 | 7.62 | 10.1 | Fig. 10 | 114-PP-320-41-117101 |
| 22 | 27.8 | 7.62 | 10.1 | Fig. 11 | 114-PP-322-41-117101 |
| 24 | 30.4 | 7.62 | 10.1 | Fig. 12 | 114-PP-324-41-117101 |
| 28 | 35.5 | 7.62 | 10.1 | Fig. 13 | 114-PP-328-41-117101 |
| 20 | 25.4 | 10.16 | 12.6 | Fig. 14 | 114-PP-420-41-117101 |
| 22 | 27.8 | 10.16 | 12.6 | Fig. 15 | 114-PP-422-41-117101 |
| 24 | 30.4 | 10.16 | 12.6 | Fig. 16 | 114-PP-424-41-117101 |
| 28 | 35.5 | 10.16 | 12.6 | Fig. 17 | 114-PP-428-41-117101 |
| 32 | 40.6 | 10.16 | 12.6 | Fig. 18 | 114-PP-432-41-117101 |
| 24 | 30.5 | 15.24 | 17.7 | Fig. 20 | 114-PP-624-41-117101 |
| 28 | 35.5 | 15.24 | 17.7 | Fig. 21 | 114-PP-628-41-117101 |
| 32 | 40.6 | 15.24 | 17.7 | Fig. 22 | 114-PP-632-41-117101 |
| 36 | 45.7 | 15.24 | 17.7 | Fig. 23 | 114-PP-636-41-117101 |
| 40 | 50.8 | 15.24 | 17.7 | Fig. 24 | 114-PP-640-41-117101 |
| 42 | 53.3 | 15.24 | 17.7 | Fig. 25 | 114-PP-642-41-117101 |
| 48 | 60.9 | 15.24 | 17.7 | Fig. 26 | 114-PP-648-41-117101 |

PCB LAYOUT

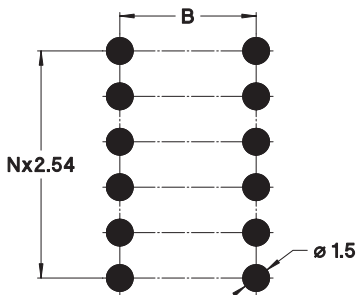



preci-dip

WWW.PRECIDIP.COM TEL +41 32 421 04 00 SALES@PRECIDIP.COM

DUAL-IN-LINE SOCKETS

OPEN FRAME / SURFACE MOUNT PICK AND PLACE

Specially designed for reflow soldering including vapor phase with unique self-aligning floating contacts.

TECHNICAL SPECIFICATIONS (FOR GENERAL SPECS, SEE PAGE 127)

| | | |
|-------------------------|--|---|
| INSULATOR | Black glass filled polyester PCT-GF30-FR | |
| FLAMMABILITY | UL 94V-0 | |
| SLEEVE | Brass CuZn36Pb3 (C36000) | |
| CONTACT CLIP (4 FINGER) | Beryllium copper (C17200) | |
| ACCEPTED PIN Ø | 0.40 to 0.56 mm | |
| FORCES | 2 N typ. insertion | 1 N typ. withdrawal (polished steel gauge Ø 0.43 mm) |
| MECHANICAL LIFE | Min. 100 cycles | |
| RATED CURRENT | 1 A | |
| CONTACT RESISTANCE | Max. 10 mΩ | |
| DIELECTRIC STRENGTH | Min. 1'000 V _{RMS} | |
| COPLANARITY | Max. 0.10 mm | |
| SMD TERMINATIONS | | |



ORDERING INFORMATION ROHS COMPLIANT PARTS

| PP PLATING CODE | SLEEVE | CLIP |
|-----------------|--------|--------------|
| 87 | Tin | Flash gold |
| 83 | Tin | 0.75 µm gold |

Other plating on request (see page 178 for plating specs).

Tape & Reel packaging:

replace 161 by suffix 191 to part number
Other pin counts please consult.



T & R Packaging

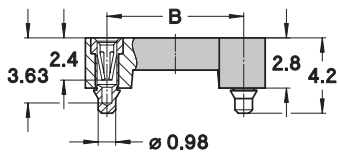

| NO. OF POLES | A | B | C | E | ORDER CODES |
|--------------|------|-------|------|------|----------------------|
| 6 | 7.6 | 7.62 | 10.1 | 7.6 | 114-PP-306-41-134161 |
| 8 | 10.1 | 7.62 | 10.1 | 10.1 | 114-PP-308-41-134161 |
| 10 | 12.6 | 7.62 | 10.1 | 12.6 | 114-PP-310-41-134161 |
| 12 | 15.2 | 7.62 | 10.1 | 5.3 | 114-PP-312-41-134161 |
| 14 | 17.8 | 7.62 | 10.1 | 5.3 | 114-PP-314-41-134161 |
| 16 | 20.3 | 7.62 | 10.1 | 5.3 | 114-PP-316-41-134161 |
| 18 | 22.9 | 7.62 | 10.1 | 5.3 | 114-PP-318-41-134161 |
| 20 | 25.4 | 7.62 | 10.1 | 8.3 | 114-PP-320-41-134161 |
| 24 | 30.4 | 7.62 | 10.1 | 8.3 | 114-PP-324-41-134161 |
| 28 | 35.6 | 7.62 | 10.1 | 8.3 | 114-PP-328-41-134161 |
| 28 | 35.5 | 15.24 | 17.7 | 10.0 | 114-PP-628-41-134161 |
| 32 | 40.6 | 15.24 | 17.7 | 10.0 | 114-PP-632-41-134161 |
| 40 | 50.8 | 15.24 | 17.7 | 10.0 | 114-PP-640-41-134161 |
| 42 | 53.4 | 15.24 | 17.7 | 10.0 | 114-PP-642-41-134161 |

DIL SOCKETS

INSULATOR

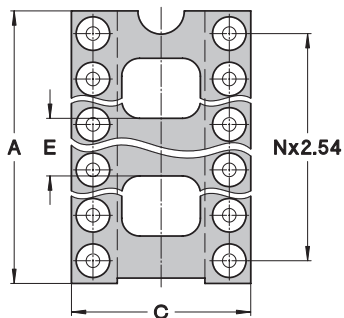

PCB LAYOUT

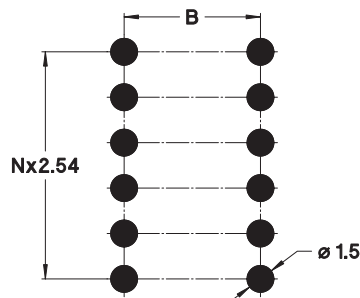



preci-dip

WWW.PRECIDIP.COM TEL +41 32 421 04 00 SALES@PRECIDIP.COM

DUAL-IN-LINE SOCKETS

INSULATOR BODIES / ULTRALOW, OPEN FRAME

306

Fig. 1

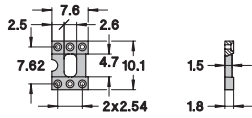

328

Fig. 10

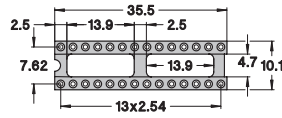

640

Fig. 19

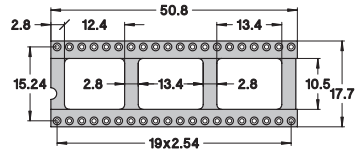

308

Fig. 2

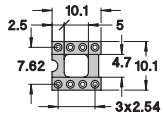

420

Fig. 11

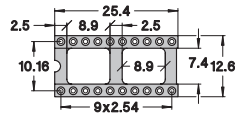

648

Fig. 20

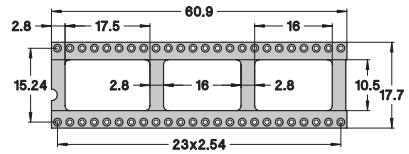

310

Fig. 3

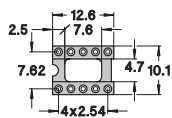

422

Fig. 12

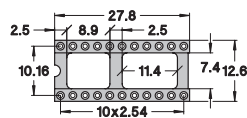

650

Fig. 21

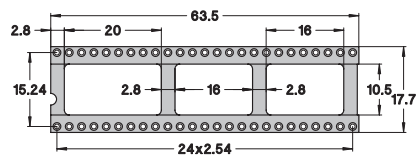

314

Fig. 4

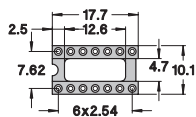

424

Fig. 13

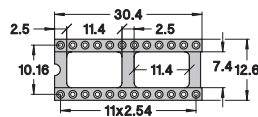

316

Fig. 5

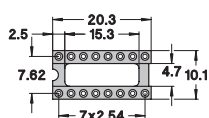

428

Fig. 14

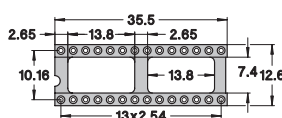

318

Fig. 6

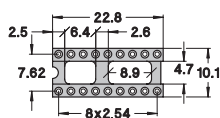

624

Fig. 15

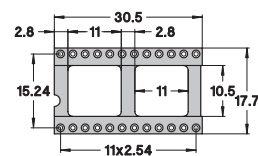

320

Fig. 7

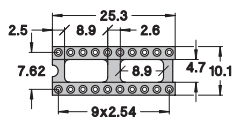

628

Fig. 16

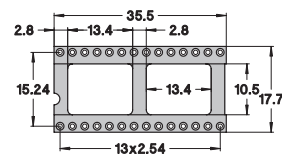

322

Fig. 8

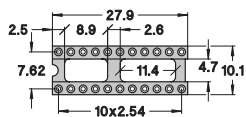

632

Fig. 17

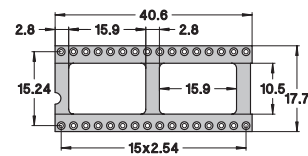

324

Fig. 9

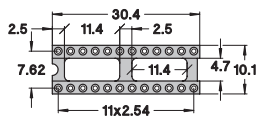

636

Fig. 18

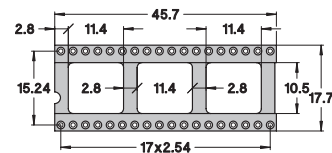

ORDERING INFORMATION

Example:

115-PP-314-41-003101 (Order Code)

314
Fig. 4

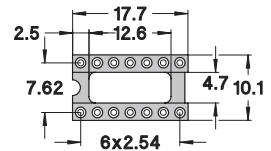



preci-dip

WWW.PRECIDIP.COM TEL +41 32 421 04 00 SALES@PRECIDIP.COM

DUAL-IN-LINE SOCKETS

ULTRALOW AND VERY LOW PROFILE / OPEN FRAME / SOLDER TAIL

"Ultralow" sockets have specially designed contacts for reduced socket height above PCB.

TECHNICAL SPECIFICATIONS (FOR GENERAL SPECS, SEE PAGE 127)

| | | |
|--------------------------------|--|---|
| INSULATOR | Black glass filled polyester PCT-GF30-FR | |
| FLAMMABILITY | UL 94V-0 | |
| SLEEVE | Brass CuZn36Pb3 (C36000) | |
| CONTACT CLIP (4 FINGER) | Beryllium copper (C17200) | |
| ACCEPTED PIN Ø | 0.40 to 0.52 mm | |
| FORCES | 3 N typ. insertion | 1.5 N typ. withdrawal (polished steel gauge Ø 0.43 mm) |
| MECHANICAL LIFE | Min. 100 cycles | |
| RATED CURRENT | 1 A | |
| CONTACT RESISTANCE | Max. 10 mΩ | |
| DIELECTRIC STRENGTH | Min. 1'000 V _{RMS} | |

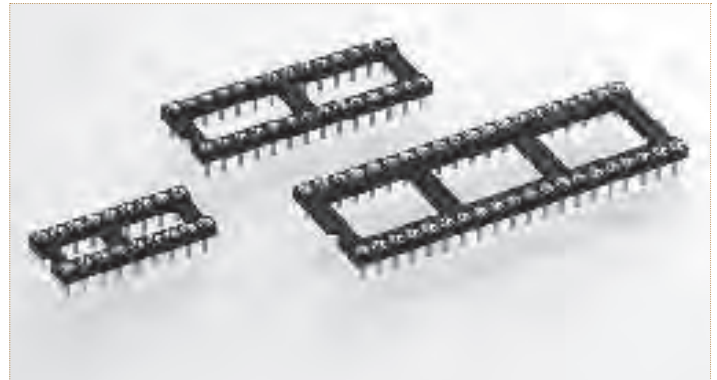

ORDERING INFORMATION ROHS COMPLIANT PARTS

| | | |
|------------------------|---------------|--------------|
| PP PLATING CODE | SLEEVE | CLIP |
| 87 | Tin | Flash gold |
| 83 | Tin | 0.75 µm gold |

Other plating on request (see page 178 for plating specs).

ULTRALOW SOCKET

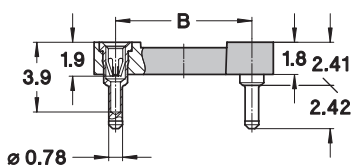
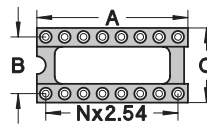

Fig. 1



| NO. OF POLES | A | B | C | SEE PAGE 136 | ORDER CODES |
|--------------|------|-------|------|--------------|----------------------|
| 6 | 7.6 | 7.62 | 10.1 | Fig. 1 | 115-PP-306-41-003101 |
| 8 | 10.1 | 7.62 | 10.1 | Fig. 2 | 115-PP-308-41-003101 |
| 10 | 12.6 | 7.62 | 10.1 | Fig. 3 | 115-PP-310-41-003101 |
| 14 | 17.7 | 7.62 | 10.1 | Fig. 4 | 115-PP-314-41-003101 |
| 16 | 20.3 | 7.62 | 10.1 | Fig. 5 | 115-PP-316-41-003101 |
| 18 | 22.8 | 7.62 | 10.1 | Fig. 6 | 115-PP-318-41-003101 |
| 20 | 25.3 | 7.62 | 10.1 | Fig. 7 | 115-PP-320-41-003101 |
| 22 | 27.9 | 7.62 | 10.1 | Fig. 8 | 115-PP-322-41-003101 |
| 24 | 30.4 | 7.62 | 10.1 | Fig. 9 | 115-PP-324-41-003101 |
| 28 | 35.5 | 7.62 | 10.1 | Fig. 10 | 115-PP-328-41-003101 |
| 20 | 25.4 | 10.16 | 12.6 | Fig. 11 | 115-PP-420-41-003101 |
| 22 | 27.8 | 10.16 | 12.6 | Fig. 12 | 115-PP-422-41-003101 |
| 24 | 30.4 | 10.16 | 12.6 | Fig. 13 | 115-PP-424-41-003101 |
| 28 | 35.5 | 10.16 | 12.6 | Fig. 14 | 115-PP-428-41-003101 |
| 24 | 30.5 | 15.24 | 17.7 | Fig. 15 | 115-PP-624-41-003101 |
| 28 | 35.5 | 15.24 | 17.7 | Fig. 16 | 115-PP-628-41-003101 |
| 32 | 40.6 | 15.24 | 17.7 | Fig. 17 | 115-PP-632-41-003101 |
| 36 | 45.7 | 15.24 | 17.7 | Fig. 18 | 115-PP-636-41-003101 |
| 40 | 50.8 | 15.24 | 17.7 | Fig. 19 | 115-PP-640-41-003101 |
| 48 | 60.9 | 15.24 | 17.7 | Fig. 20 | 115-PP-648-41-003101 |
| 50 | 63.5 | 15.24 | 17.7 | Fig. 21 | 115-PP-650-41-003101 |

OPTIONS: VERY LOW VERSION

Very low version (Fig. 2) is optional; change suffix 003101 to 001101. Insulator body dimensions see page 128 Fig. 1 to 31. Same number of poles as standard series 110.

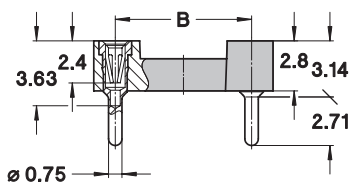

Fig. 2

DIL SOCKETS



preci-dip

WWW.PRECIDIP.COM TEL +41 32 421 04 00 SALES@PRECIDIP.COM

DUAL-IN-LINE SOCKETS

INTERCONNECT / OPEN FRAME / SOLDER TAIL

For mechanical and electrical interconnection, PCB stacking or elevated positioning of display modules.

TECHNICAL SPECIFICATIONS (FOR GENERAL SPECS, SEE PAGE 127)

| | |
|--------------------------------|---|
| INSULATOR | Black glass filled polyester PCT-GF30-FR |
| FLAMMABILITY | UL 94V-0 |
| SLEEVE | Brass CuZn36Pb3 (C36000) |
| CONTACT CLIP (4 FINGER) | Beryllium copper (C17200) |
| ACCEPTED PIN Ø | 0.40 to 0.56 mm |
| FORCES | 2 N typ. insertion 1 N typ. withdrawal (polished steel gauge Ø 0.43 mm) |
| MECHANICAL LIFE | Min. 100 cycles |
| RATED CURRENT | 1 A |
| CONTACT RESISTANCE | Max. 10 mΩ |
| DIELECTRIC STRENGTH | Min. 1'000 V _{RMS} |

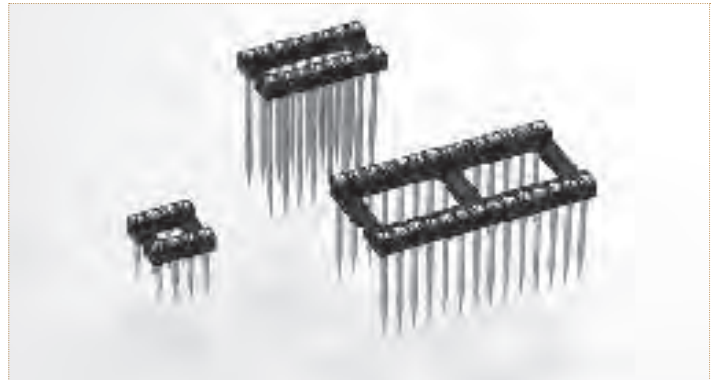

ORDERING INFORMATION ROHS COMPLIANT PARTS

| | | |
|------------------------|---------------|--------------|
| PP PLATING CODE | SLEEVE | CLIP |
| 87 | Tin | Flash gold |
| 83 | Tin | 0.75 µm gold |

Other plating on request (see page 178 for plating specs).

For complete part number replace **XXX** with the code given below left for the required contact length **L**.

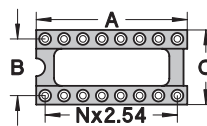
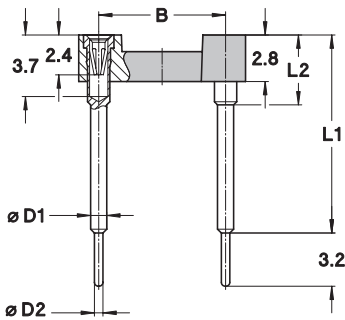

| NO. OF POLES | A | B | C | SEE PAGE 128 | ORDER CODES |
|--------------|------|-------|------|--------------|----------------------|
| 10 | 12.6 | 5.08 | 7.6 | Fig. 1 | 116-PP-210-41-XXX101 |
| 4 | 5.0 | 7.62 | 10.1 | Fig. 2 | 116-PP-304-41-XXX101 |
| 6 | 7.6 | 7.62 | 10.1 | Fig. 3 | 116-PP-306-41-XXX101 |
| 8 | 10.1 | 7.62 | 10.1 | Fig. 4 | 116-PP-308-41-XXX101 |
| 10 | 12.6 | 7.62 | 10.1 | Fig. 5 | 116-PP-310-41-XXX101 |
| 12 | 15.2 | 7.62 | 10.1 | Fig. 6 | 116-PP-312-41-XXX101 |
| 14 | 17.7 | 7.62 | 10.1 | Fig. 7 | 116-PP-314-41-XXX101 |
| 16 | 20.3 | 7.62 | 10.1 | Fig. 8 | 116-PP-316-41-XXX101 |
| 18 | 22.8 | 7.62 | 10.1 | Fig. 9 | 116-PP-318-41-XXX101 |
| 20 | 25.3 | 7.62 | 10.1 | Fig. 10 | 116-PP-320-41-XXX101 |
| 22 | 27.8 | 7.62 | 10.1 | Fig. 11 | 116-PP-322-41-XXX101 |
| 24 | 30.4 | 7.62 | 10.1 | Fig. 12 | 116-PP-324-41-XXX101 |
| 28 | 35.5 | 7.62 | 10.1 | Fig. 13 | 116-PP-328-41-XXX101 |
| 20 | 25.4 | 10.16 | 12.6 | Fig. 14 | 116-PP-420-41-XXX101 |
| 22 | 27.8 | 10.16 | 12.6 | Fig. 15 | 116-PP-422-41-XXX101 |
| 24 | 30.4 | 10.16 | 12.6 | Fig. 16 | 116-PP-424-41-XXX101 |
| 28 | 35.5 | 10.16 | 12.6 | Fig. 17 | 116-PP-428-41-XXX101 |
| 32 | 40.6 | 10.16 | 12.6 | Fig. 18 | 116-PP-432-41-XXX101 |
| 10 | 12.7 | 15.24 | 17.7 | Fig. 19 | 116-PP-610-41-XXX101 |
| 24 | 30.5 | 15.24 | 17.7 | Fig. 20 | 116-PP-624-41-XXX101 |
| 28 | 35.5 | 15.24 | 17.7 | Fig. 21 | 116-PP-628-41-XXX101 |
| 32 | 40.6 | 15.24 | 17.7 | Fig. 22 | 116-PP-632-41-XXX101 |
| 36 | 45.7 | 15.24 | 17.7 | Fig. 23 | 116-PP-636-41-XXX101 |
| 40 | 50.8 | 15.24 | 17.7 | Fig. 24 | 116-PP-640-41-XXX101 |
| 42 | 53.3 | 15.24 | 17.7 | Fig. 25 | 116-PP-642-41-XXX101 |
| 48 | 60.9 | 15.24 | 17.7 | Fig. 26 | 116-PP-648-41-XXX101 |
| 50 | 63.5 | 15.24 | 17.7 | Fig. 27 | 116-PP-650-41-XXX101 |
| 52 | 66.0 | 15.24 | 17.7 | Fig. 28 | 116-PP-652-41-XXX101 |
| 50 | 63.5 | 22.86 | 25.3 | Fig. 29 | 116-PP-950-41-XXX101 |
| 52 | 66.0 | 22.86 | 25.3 | Fig. 30 | 116-PP-952-41-XXX101 |
| 64 | 81.2 | 22.86 | 25.3 | Fig. 31 | 116-PP-964-41-XXX101 |

AVAILABLE CONTACT LENGTHS

| CONTACT LENGTH L1 (mm) | L2 (mm) | CONTACT DIAMETER | | XXX CODE |
|---------------------------|---------|------------------|---------|----------|
| | | D1 (mm) | D2 (mm) | |
| 6 | 4.2 | 1 | 0.51 | 006 |
| 7 | 4.2 | 1 | 0.51 | 018 |
| 8 | 4.2 | 1 | 0.51 | 003 |
| 9 | 4.85 | 1 | 0.46 | 012 |
| 10 | 4.2 | 1 | 0.51 | 007 |
| 11 | 4.2 | 0.85 | 0.51 | 002 |
| 12 | 4.2 | 1 | 0.51 | 008 |
| 13 | 4.2 | 1 | 0.51 | 009 |
| 15 | 4.2 | 1 | 0.51 | 001 |
| 18 | 4.2 | 1 | 0.51 | 011 |
| 22 | 4.2 | 1 | 0.51 | 004 |
| 33 | 4.2 | 1.18 | 0.51 | 013 |



preci-dip

WWW.PRECIDIP.COM TEL +41 32 421 04 00 SALES@PRECIDIP.COM

DUAL-IN-LINE SOCKETS

OPEN FRAME / WIRE-WRAP

Solderless wire-wrap terminals are firmly fitted in the insulator body to withstand torque of wrapping tool.

TECHNICAL SPECIFICATIONS (FOR GENERAL SPECS, SEE PAGE 127)

| | |
|--------------------------------|---|
| INSULATOR | Black glass filled polyester PCT-GF30-FR |
| FLAMMABILITY | UL 94V-0 |
| SLEEVE | Brass CuZn36Pb3 (C36000) |
| CONTACT CLIP (4 FINGER) | Beryllium copper (C17200) |
| ACCEPTED PIN Ø | 0.40 to 0.56 mm |
| FORCES | 2 N typ. insertion 1 N typ. withdrawal (polished steel gauge Ø 0.43 mm) |
| MECHANICAL LIFE | Min. 100 cycles |
| RATED CURRENT | 1 A |
| CONTACT RESISTANCE | Max. 10 mΩ |
| DIELECTRIC STRENGTH | Min. 1'000 V _{RMS} |



ORDERING INFORMATION ROHS COMPLIANT PARTS

| | | |
|------------------------|---------------|--------------|
| PP PLATING CODE | SLEEVE | CLIP |
| 87 | Tin | Flash gold |
| 83 | Tin | 0.75 µm gold |

Other plating on request (see page 178 for plating specs).

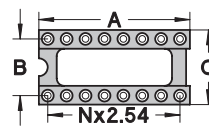
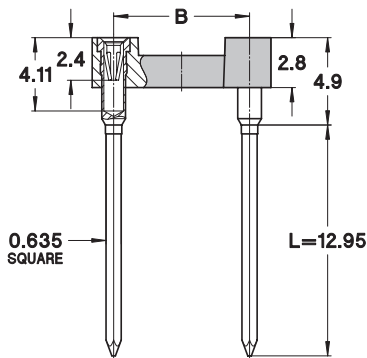

| NO. OF POLES | A | B | C | SEE PAGE 128 | ORDER CODES |
|--------------|------|-------|------|--------------|----------------------|
| 10 | 12.6 | 5.08 | 7.6 | Fig. 1 | 123-PP-210-41-001101 |
| 4 | 5.0 | 7.62 | 10.1 | Fig. 2 | 123-PP-304-41-001101 |
| 6 | 7.6 | 7.62 | 10.1 | Fig. 3 | 123-PP-306-41-001101 |
| 8 | 10.1 | 7.62 | 10.1 | Fig. 4 | 123-PP-308-41-001101 |
| 10 | 12.6 | 7.62 | 10.1 | Fig. 5 | 123-PP-310-41-001101 |
| 12 | 15.2 | 7.62 | 10.1 | Fig. 6 | 123-PP-312-41-001101 |
| 14 | 17.7 | 7.62 | 10.1 | Fig. 7 | 123-PP-314-41-001101 |
| 16 | 20.3 | 7.62 | 10.1 | Fig. 8 | 123-PP-316-41-001101 |
| 18 | 22.8 | 7.62 | 10.1 | Fig. 9 | 123-PP-318-41-001101 |
| 20 | 25.3 | 7.62 | 10.1 | Fig. 10 | 123-PP-320-41-001101 |
| 22 | 27.8 | 7.62 | 10.1 | Fig. 11 | 123-PP-322-41-001101 |
| 24 | 30.4 | 7.62 | 10.1 | Fig. 12 | 123-PP-324-41-001101 |
| 28 | 35.5 | 7.62 | 10.1 | Fig. 13 | 123-PP-328-41-001101 |
| 20 | 25.4 | 10.16 | 12.6 | Fig. 14 | 123-PP-420-41-001101 |
| 22 | 27.8 | 10.16 | 12.6 | Fig. 15 | 123-PP-422-41-001101 |
| 24 | 30.4 | 10.16 | 12.6 | Fig. 16 | 123-PP-424-41-001101 |
| 28 | 35.5 | 10.16 | 12.6 | Fig. 17 | 123-PP-428-41-001101 |
| 32 | 40.6 | 10.16 | 12.6 | Fig. 18 | 123-PP-432-41-001101 |
| 10 | 12.7 | 15.24 | 17.7 | Fig. 19 | 123-PP-610-41-001101 |
| 24 | 30.5 | 15.24 | 17.7 | Fig. 20 | 123-PP-624-41-001101 |
| 28 | 35.5 | 15.24 | 17.7 | Fig. 21 | 123-PP-628-41-001101 |
| 32 | 40.6 | 15.24 | 17.7 | Fig. 22 | 123-PP-632-41-001101 |
| 36 | 45.7 | 15.24 | 17.7 | Fig. 23 | 123-PP-636-41-001101 |
| 40 | 50.8 | 15.24 | 17.7 | Fig. 24 | 123-PP-640-41-001101 |
| 42 | 53.3 | 15.24 | 17.7 | Fig. 25 | 123-PP-642-41-001101 |
| 48 | 60.9 | 15.24 | 17.7 | Fig. 26 | 123-PP-648-41-001101 |
| 50 | 63.5 | 15.24 | 17.7 | Fig. 27 | 123-PP-650-41-001101 |
| 52 | 66.0 | 15.24 | 17.7 | Fig. 28 | 123-PP-652-41-001101 |
| 50 | 63.5 | 22.86 | 25.3 | Fig. 29 | 123-PP-950-41-001101 |
| 52 | 66.0 | 22.86 | 25.3 | Fig. 30 | 123-PP-952-41-001101 |
| 64 | 81.2 | 22.86 | 25.3 | Fig. 31 | 123-PP-964-41-001101 |

OPTION

Other lengths for 1-level, 2-level or 4-level wrapping available on request

Replace 123-... in order code by

| | | |
|---------------------|-------------|------------|
| - 121-83-... | for 1-level | L = 6.6 mm |
| - 122-... | for 2-level | L = 9.4 mm |
| - 124-83-...-002101 | for 4-level | L = 16 mm |



preci-dip

WWW.PRECIDIP.COM TEL +41 32 421 04 00 SALES@PRECIDIP.COM

DUAL-IN-LINE SOCKETS

INSULATOR BODIES / SHRINKDIP, OPEN FRAME

316

Fig. 1

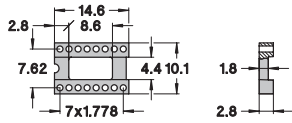

642

Fig. 10

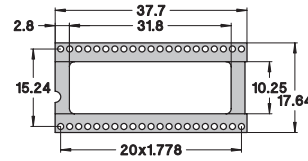

764

Fig. 16

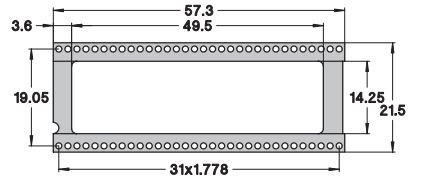

428

Fig. 2

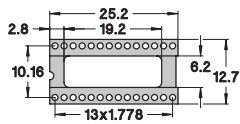

648

Fig. 11

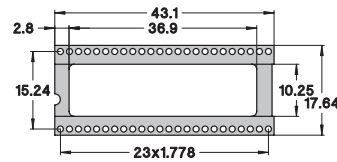

430

Fig. 3

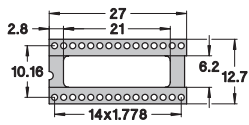

652

Fig. 12

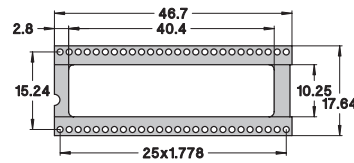

432

Fig. 4

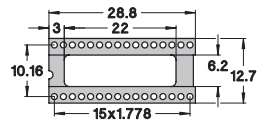

656

Fig. 13

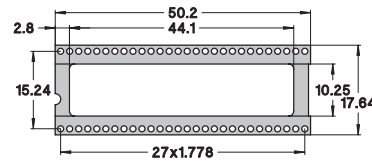

448

Fig. 5

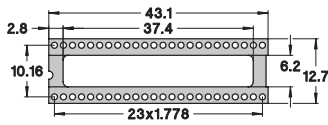

664

Fig. 14

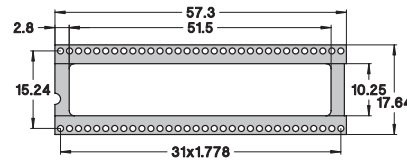

620

Fig. 6

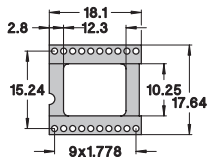

668

Fig. 15

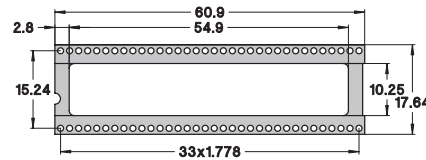

624

Fig. 7

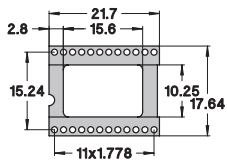

628

Fig. 8

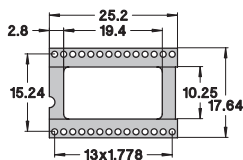

640

Fig. 9

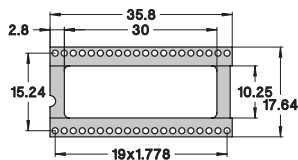

ORDERING INFORMATION

Example:

117-PP-624-41-005101 (Order Code)

624
Fig. 7

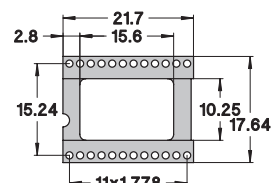



preci-dip

WWW.PRECIDIP.COM TEL +41 32 421 04 00 SALES@PRECIDIP.COM

SHRINKDIP SOCKETS

OPEN FRAME / SOLDER TAIL

High density DIL sockets for devices featuring 0.07" (1.778 mm) lead spacing.

TECHNICAL SPECIFICATIONS (FOR GENERAL SPECS, SEE PAGE 127)

| | |
|--------------------------------|---|
| INSULATOR | Black glass filled polyester PCT-GF30-FR |
| FLAMMABILITY | UL 94V-0 |
| SLEEVE | Brass CuZn36Pb3 (C36000) |
| CONTACT CLIP (4 FINGER) | Beryllium copper (C17200) |
| ACCEPTED PIN Ø | 0.40 to 0.56 mm |
| FORCES | 2 N typ. insertion 1 N typ. withdrawal (polished steel gauge Ø 0.43 mm) |
| MECHANICAL LIFE | Min. 100 cycles |
| RATED CURRENT | 1 A |
| CONTACT RESISTANCE | Max. 10 mΩ |
| DIELECTRIC STRENGTH | Min. 1'000 V _{RMS} |



ORDERING INFORMATION ROHS COMPLIANT PARTS

| | | |
|------------------------|---------------|--------------|
| PP PLATING CODE | SLEEVE | CLIP |
| 87 | Tin | Flash gold |
| 83 | Tin | 0.75 µm gold |

Other plating on request (see page 178 for plating specs).

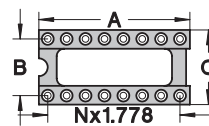
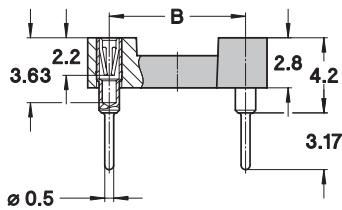

| NO. OF POLES | A | B | C | SEE PAGE 140 | ORDER CODES |
|--------------|------|-------|-------|--------------|----------------------|
| 16 | 14.6 | 7.62 | 10.10 | Fig. 1 | 117-PP-316-41-005101 |
| 28 | 25.2 | 10.16 | 12.70 | Fig. 2 | 117-PP-428-41-005101 |
| 30 | 27.0 | 10.16 | 12.70 | Fig. 3 | 117-PP-430-41-005101 |
| 32 | 28.8 | 10.16 | 12.70 | Fig. 4 | 117-PP-432-41-005101 |
| 48 | 43.1 | 10.16 | 12.70 | Fig. 5 | 117-PP-448-41-005101 |
| 20 | 18.1 | 15.24 | 17.64 | Fig. 6 | 117-PP-620-41-005101 |
| 24 | 21.7 | 15.24 | 17.64 | Fig. 7 | 117-PP-624-41-005101 |
| 28 | 25.2 | 15.24 | 17.64 | Fig. 8 | 117-PP-628-41-005101 |
| 40 | 35.8 | 15.24 | 17.64 | Fig. 9 | 117-PP-640-41-005101 |
| 42 | 37.7 | 15.24 | 17.64 | Fig. 10 | 117-PP-642-41-005101 |
| 48 | 43.1 | 15.24 | 17.64 | Fig. 11 | 117-PP-648-41-005101 |
| 52 | 46.7 | 15.24 | 17.64 | Fig. 12 | 117-PP-652-41-005101 |
| 56 | 50.2 | 15.24 | 17.64 | Fig. 13 | 117-PP-656-41-005101 |
| 64 | 57.3 | 15.24 | 17.64 | Fig. 14 | 117-PP-664-41-005101 |
| 68 | 60.9 | 15.24 | 17.64 | Fig. 15 | 117-PP-668-41-005101 |
| 64* | 57.3 | 19.05 | 21.50 | Fig. 16 | 117-PP-764-41-005101 |

OPTIONS AVAILABLE ON REQUEST

- * Socket 117-PP-764-41-005101 available with closed frame insulator PN 217-PP-764-41-005101
- Surface mount Shrinkdip socket with gull wing terminations Series 117-...-41-105101
- Shrinkdip pin header, solder tail Series 150-10...-00-012101 or 150-80...-00-012101

Please consult



preci-dip

WWW.PRECIDIP.COM TEL +41 32 421 04 00 SALES@PRECIDIP.COM

DUAL-IN-LINE SOCKETS

OPEN FRAME / PRESS-FIT

DIL Sockets with compliant press-fit pin for solderless mount in PCB plated through holes.

TECHNICAL SPECIFICATIONS (FOR GENERAL SPECS, SEE PAGE 127)

| | |
|--------------------------------|---|
| INSULATOR | Black glass filled polyester PCT-GF30-FR |
| FLAMMABILITY | UL 94V-0 |
| SLEEVE | Bronze CuSn4Pb4Zn4 (C54400) |
| CONTACT CLIP (4 FINGER) | Beryllium copper (C17200) |
| ACCEPTED PIN Ø | 0.40 to 0.56 mm |
| FORCES | 2 N typ. insertion 1 N typ. withdrawal (polished steel gauge Ø 0.43 mm) |
| MECHANICAL LIFE | Min. 500 cycles |
| RATED CURRENT | 1 A |
| CONTACT RESISTANCE | Max. 10 mΩ |
| DIELECTRIC STRENGTH | Min. 1'000 V _{RMS} |
| PCB HOLE Ø | 1 +0.09/-0.06 mm finished (1.15 ±0.025 mm drill) |

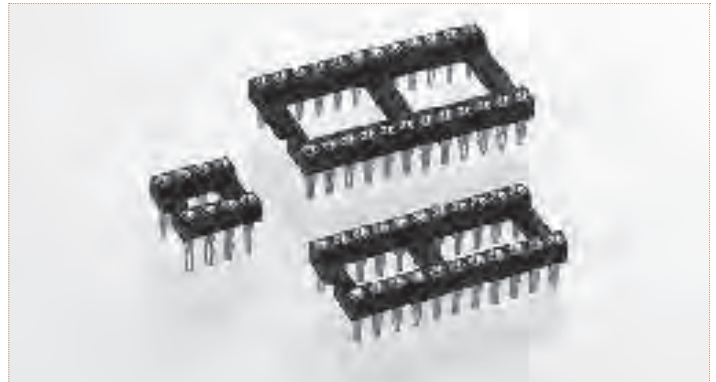

ORDERING INFORMATION ROHS COMPLIANT PARTS

| PP PLATING CODE | SLEEVE | CLIP |
|-----------------|--------|--------------|
| 87 | Tin | Flash gold |
| 83 | Tin | 0.75 µm gold |

Other plating on request (see page 178 for plating specs).

For complete part number replace **XXX** with the code given below left for the required contact length **L**.

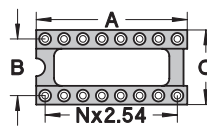
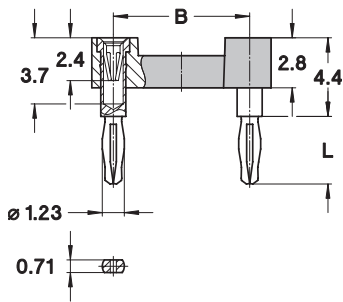

| NO. OF POLES | A | B | C | SEE PAGE 128 | ORDER CODES |
|--------------|------|-------|------|--------------|----------------------|
| 10 | 12.6 | 5.08 | 7.6 | Fig. 1 | 146-PP-210-41-XXX101 |
| 4 | 5.0 | 7.62 | 10.1 | Fig. 2 | 146-PP-304-41-XXX101 |
| 6 | 7.6 | 7.62 | 10.1 | Fig. 3 | 146-PP-306-41-XXX101 |
| 8 | 10.1 | 7.62 | 10.1 | Fig. 4 | 146-PP-308-41-XXX101 |
| 10 | 12.6 | 7.62 | 10.1 | Fig. 5 | 146-PP-310-41-XXX101 |
| 12 | 15.2 | 7.62 | 10.1 | Fig. 6 | 146-PP-312-41-XXX101 |
| 14 | 17.7 | 7.62 | 10.1 | Fig. 7 | 146-PP-314-41-XXX101 |
| 16 | 20.3 | 7.62 | 10.1 | Fig. 8 | 146-PP-316-41-XXX101 |
| 18 | 22.8 | 7.62 | 10.1 | Fig. 9 | 146-PP-318-41-XXX101 |
| 20 | 25.3 | 7.62 | 10.1 | Fig. 10 | 146-PP-320-41-XXX101 |
| 22 | 27.8 | 7.62 | 10.1 | Fig. 11 | 146-PP-322-41-XXX101 |
| 24 | 30.4 | 7.62 | 10.1 | Fig. 12 | 146-PP-324-41-XXX101 |
| 28 | 35.5 | 7.62 | 10.1 | Fig. 13 | 146-PP-328-41-XXX101 |
| 20 | 25.4 | 10.16 | 12.6 | Fig. 14 | 146-PP-420-41-XXX101 |
| 22 | 27.8 | 10.16 | 12.6 | Fig. 15 | 146-PP-422-41-XXX101 |
| 24 | 30.4 | 10.16 | 12.6 | Fig. 16 | 146-PP-424-41-XXX101 |
| 28 | 35.5 | 10.16 | 12.6 | Fig. 17 | 146-PP-428-41-XXX101 |
| 32 | 40.6 | 10.16 | 12.6 | Fig. 18 | 146-PP-432-41-XXX101 |
| 24 | 30.5 | 15.24 | 17.7 | Fig. 20 | 146-PP-624-41-XXX101 |
| 28 | 35.5 | 15.24 | 17.7 | Fig. 21 | 146-PP-628-41-XXX101 |
| 32 | 40.6 | 15.24 | 17.7 | Fig. 22 | 146-PP-632-41-XXX101 |
| 36 | 45.7 | 15.24 | 17.7 | Fig. 23 | 146-PP-636-41-XXX101 |
| 40 | 50.8 | 15.24 | 17.7 | Fig. 24 | 146-PP-640-41-XXX101 |

AVAILABLE CONTACT LENGTH

| CONTACT LENGTH L (mm) | PCB THICKNESS (mm) | XXX CODE |
|-----------------------|--------------------|----------|
| 2.8 | 1.5-2.0 | 036 |
| 3.8 | 2.1-3.2 | 035 |



preci-dip

WWW.PRECIDIP.COM TEL +41 32 421 04 00 SALES@PRECIDIP.COM

DUAL-IN-LINE PIN CARRIER ASSEMBLIES

LOW PROFILE / LOW PROFILE ULTRA THIN / SOLDER TAIL

Easy mounting due to the disposable plastic carrier, no solder or flux wicking problems.

TECHNICAL SPECIFICATIONS (FOR GENERAL SPECS, SEE PAGE 127)

| | |
|---|--|
| INSULATOR | Black glass filled polyester PCT-GF30-FR |
| FLAMMABILITY | UL 94V-0 |
| SLEEVE | Brass CuZn36Pb3 (C36000) |
| CONTACT CLIP (4 FINGER) (3 FINGER) | Beryllium copper (C17200) (Series 614...012101) |
| ACCEPTED PIN Ø | 0.40 to 0.56 mm |
| FORCES | 2 N typ. (1.0 N typ. 614...012001) insertion 1 N typ. (0.4 N typ. 614...012001) withdrawal (polished steel gauge Ø 0.43 mm) |
| MECHANICAL LIFE | Min. 100 cycles |
| RATED CURRENT | 1 A |
| CONTACT RESISTANCE | Max. 10 mΩ |
| DIELECTRIC STRENGTH | Min. 1'000 V _{RMS} |



ORDERING INFORMATION ROHS COMPLIANT PARTS

| PP PLATING CODE | SLEEVE | CLIP |
|-----------------|--------|--------------|
| 87 | Tin | Flash gold |
| 83 | Tin | 0.75 µm gold |

Other plating on request (see page 178 for plating specs).

For complete part number replace X...-XX-XXX with the code given below left.

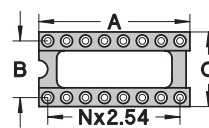
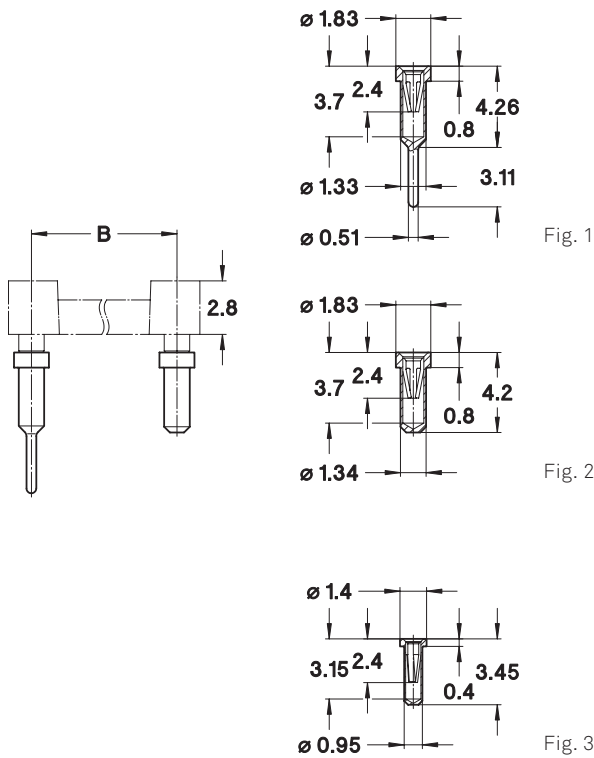

| NO. OF POLES | A | B | C | SEE PAGE 128 | ORDER CODES |
|--------------|------|-------|------|--------------|----------------------|
| 10 | 12.6 | 5.08 | 7.6 | Fig. 1 | 61X-PP-210-XX-XXX101 |
| 4 | 5.0 | 7.62 | 10.1 | Fig. 2 | 61X-PP-304-XX-XXX101 |
| 6 | 7.6 | 7.62 | 10.1 | Fig. 3 | 61X-PP-306-XX-XXX101 |
| 8 | 10.1 | 7.62 | 10.1 | Fig. 4 | 61X-PP-308-XX-XXX101 |
| 10 | 12.6 | 7.62 | 10.1 | Fig. 5 | 61X-PP-310-XX-XXX101 |
| 12 | 15.2 | 7.62 | 10.1 | Fig. 6 | 61X-PP-312-XX-XXX101 |
| 14 | 17.7 | 7.62 | 10.1 | Fig. 7 | 61X-PP-314-XX-XXX101 |
| 16 | 20.3 | 7.62 | 10.1 | Fig. 8 | 61X-PP-316-XX-XXX101 |
| 18 | 22.8 | 7.62 | 10.1 | Fig. 9 | 61X-PP-318-XX-XXX101 |
| 20 | 25.3 | 7.62 | 10.1 | Fig. 10 | 61X-PP-320-XX-XXX101 |
| 22 | 27.8 | 7.62 | 10.1 | Fig. 11 | 61X-PP-322-XX-XXX101 |
| 24 | 30.4 | 7.62 | 10.1 | Fig. 12 | 61X-PP-324-XX-XXX101 |
| 28 | 35.5 | 7.62 | 10.1 | Fig. 13 | 61X-PP-328-XX-XXX101 |
| 20 | 25.4 | 10.16 | 12.6 | Fig. 14 | 61X-PP-420-XX-XXX101 |
| 22 | 27.8 | 10.16 | 12.6 | Fig. 15 | 61X-PP-422-XX-XXX101 |
| 24 | 30.4 | 10.16 | 12.6 | Fig. 16 | 61X-PP-424-XX-XXX101 |
| 28 | 35.5 | 10.16 | 12.6 | Fig. 17 | 61X-PP-428-XX-XXX101 |
| 32 | 40.6 | 10.16 | 12.6 | Fig. 18 | 61X-PP-432-XX-XXX101 |
| 10 | 12.7 | 15.24 | 17.7 | Fig. 19 | 61X-PP-610-XX-XXX101 |
| 24 | 30.5 | 15.24 | 17.7 | Fig. 20 | 61X-PP-624-XX-XXX101 |
| 28 | 35.5 | 15.24 | 17.7 | Fig. 21 | 61X-PP-628-XX-XXX101 |
| 32 | 40.6 | 15.24 | 17.7 | Fig. 22 | 61X-PP-632-XX-XXX101 |
| 36 | 45.7 | 15.24 | 17.7 | Fig. 23 | 61X-PP-636-XX-XXX101 |
| 40 | 50.8 | 15.24 | 17.7 | Fig. 24 | 61X-PP-640-XX-XXX101 |
| 42 | 53.3 | 15.24 | 17.7 | Fig. 25 | 61X-PP-642-XX-XXX101 |
| 48 | 60.9 | 15.24 | 17.7 | Fig. 26 | 61X-PP-648-XX-XXX101 |
| 50 | 63.5 | 15.24 | 17.7 | Fig. 27 | 61X-PP-650-XX-XXX101 |
| 52 | 66.0 | 15.24 | 17.7 | Fig. 28 | 61X-PP-652-XX-XXX101 |
| 50 | 63.5 | 22.86 | 25.3 | Fig. 29 | 61X-PP-950-XX-XXX101 |
| 52 | 66.0 | 22.86 | 25.3 | Fig. 30 | 61X-PP-952-XX-XXX101 |
| 64 | 81.2 | 22.86 | 25.3 | Fig. 31 | 61X-PP-964-XX-XXX101 |

AVAILABLE VERSIONS

- **Standard carrier** 612...-41-001101
see Fig. 1
- **Low profile** 614...-41-001101
see Fig. 2 for PCB hole Ø 1.4-1.8 mm
- **Low profile, ultra thin** 614...-31-012101
see Fig. 3 for PCB hole Ø 1.0-1.3 mm



preci-dip

WWW.PRECIDIP.COM TEL +41 32 421 04 00 SALES@PRECIDIP.COM

DUAL-IN-LINE SOCKETS

RIGHT ANGLE VERSION / CLOSED FRAME / SOLDER TAIL

Right angle DIL Sockets for components to be mounted perpendicularly to the PCB such as displays.

TECHNICAL SPECIFICATIONS (FOR GENERAL SPECS, SEE PAGE 127)

| | |
|--------------------------------|---|
| INSULATOR | Black glass filled polyester PCT-GF30-FR |
| FLAMMABILITY | UL 94V-0 |
| SLEEVE | Brass CuZn36Pb3 (C36000) |
| CONTACT CLIP (4 FINGER) | Beryllium copper (C17200) |
| ACCEPTED PIN Ø | 0.40 to 0.56 mm |
| FORCES | 2 N typ. insertion 1 N typ. withdrawal (polished steel gauge Ø 0.43 mm) |
| MECHANICAL LIFE | Min. 100 cycles |
| RATED CURRENT | 1 A |
| CONTACT RESISTANCE | Max. 10 mΩ |
| DIELECTRIC STRENGTH | Min. 1'000 V _{RMS} |

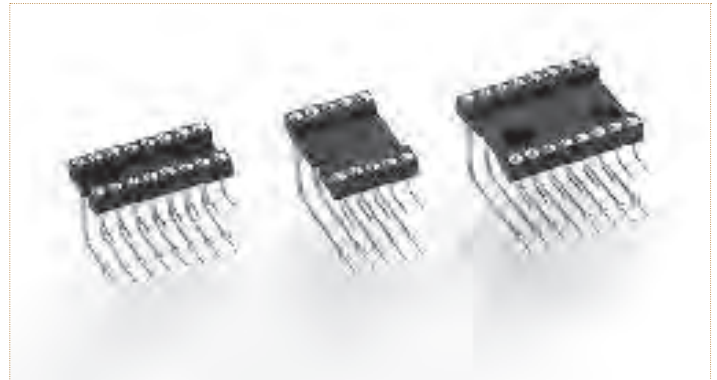

ORDERING INFORMATION ROHS COMPLIANT PARTS

| | | |
|------------------------|---------------|--------------|
| PP PLATING CODE | SLEEVE | CLIP |
| 87 | Tin | Flash gold |
| 83 | Tin | 0.75 µm gold |

Other plating on request (see page 178 for plating specs).

For complete part number replace **XX** with the code given below left.

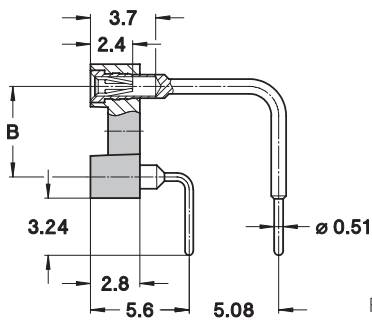

Fig. 1

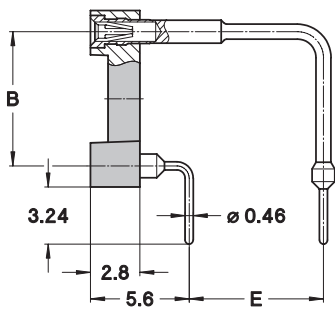

Fig. 2

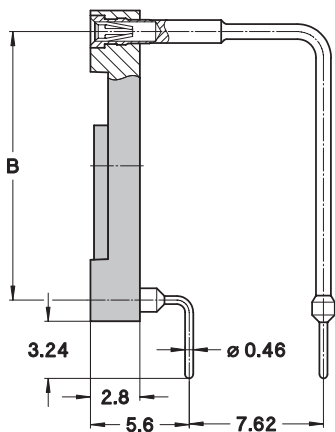
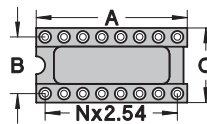

Fig. 3



| NO. OF POLES | A | B | C | SEE | ORDER CODES |
|--------------|------|-------|------|--------|----------------------|
| 10 | 12.6 | 5.08 | 7.6 | Fig. 1 | 299-PP-210-10-001101 |
| 6 | 7.6 | 7.62 | 10.1 | Fig. 2 | 299-PP-306-XX-001101 |
| 8 | 10.1 | 7.62 | 10.1 | Fig. 2 | 299-PP-308-XX-001101 |
| 10 | 12.6 | 7.62 | 10.1 | Fig. 2 | 299-PP-310-XX-001101 |
| 12 | 15.2 | 7.62 | 10.1 | Fig. 2 | 299-PP-312-XX-001101 |
| 14 | 17.7 | 7.62 | 10.1 | Fig. 2 | 299-PP-314-XX-001101 |
| 16 | 20.3 | 7.62 | 10.1 | Fig. 2 | 299-PP-316-XX-001101 |
| 18 | 22.8 | 7.62 | 10.1 | Fig. 2 | 299-PP-318-XX-001101 |
| 20 | 25.3 | 7.62 | 10.1 | Fig. 2 | 299-PP-320-XX-001101 |
| 22 | 27.8 | 7.62 | 10.1 | Fig. 2 | 299-PP-322-XX-001101 |
| 24 | 30.4 | 7.62 | 10.1 | Fig. 2 | 299-PP-324-XX-001101 |
| 8 | 10.1 | 15.24 | 17.7 | Fig. 3 | 299-PP-608-10-002101 |
| 10 | 12.6 | 15.24 | 17.7 | Fig. 3 | 299-PP-610-10-002101 |
| 12 | 15.2 | 15.24 | 10.1 | Fig. 3 | 299-PP-612-10-002101 |
| 14 | 17.7 | 15.24 | 10.1 | Fig. 3 | 299-PP-614-10-002101 |
| 16 | 20.1 | 15.24 | 17.7 | Fig. 3 | 299-PP-616-10-002101 |
| 18 | 22.8 | 15.24 | 17.7 | Fig. 3 | 299-PP-618-10-002101 |
| 20 | 25.3 | 15.24 | 17.7 | Fig. 3 | 299-PP-620-10-002101 |
| 22 | 27.8 | 15.24 | 17.7 | Fig. 3 | 299-PP-622-10-002101 |
| 24 | 30.4 | 15.24 | 17.7 | Fig. 3 | 299-PP-624-10-002101 |
| 26 | 33.0 | 15.24 | 17.7 | Fig. 3 | 299-PP-626-10-002101 |
| 28 | 35.5 | 15.24 | 17.7 | Fig. 3 | 299-PP-628-10-002101 |
| 30 | 38.0 | 15.24 | 17.7 | Fig. 3 | 299-PP-630-10-002101 |
| 32 | 40.6 | 15.24 | 17.7 | Fig. 3 | 299-PP-632-10-002101 |
| 36 | 45.7 | 15.24 | 17.7 | Fig. 3 | 299-PP-636-10-002101 |
| 40 | 50.6 | 15.24 | 17.7 | Fig. 3 | 299-PP-640-10-002101 |
| 48 | 61.0 | 15.24 | 17.7 | Fig. 3 | 299-PP-648-10-002101 |



preci-dip

WWW.PRECIDIP.COM TEL +41 32 421 04 00 SALES@PRECIDIP.COM

DUAL-IN-LINE PIN HEADERS

OPEN FRAME / SOLDER TAIL

DIL pin headers with male contacts pluggable into standard female socket contacts.

TECHNICAL SPECIFICATIONS (FOR GENERAL SPECS, SEE PAGE 127)

| | |
|----------------------------|--|
| INSULATOR | Black glass filled polyester PCT-GF30-FR |
| FLAMMABILITY | UL 94V-0 |
| CONTACT | Brass CuZn36Pb3 (C36000) |
| CONNECTING PIN Ø | 0.47 mm / 0.76 mm |
| MECHANICAL LIFE | Min. 100 cycles |
| RATED CURRENT | 1 A |
| DIELECTRIC STRENGTH | Min. 1'000 V _{RMS} |

ORDERING INFORMATION ROHS COMPLIANT PARTS

| | | |
|------------------------|--------------------|-----------------------|
| PP PLATING CODE | TERMINATION | CONNECTING PIN |
| 10 | 0.25 µm gold | 0.25 µm gold |
| 80 | Tin | Tin |



Other plating on request (see page 178 for plating specs).

For complete part number replace X-...-XXX with the code given below left.

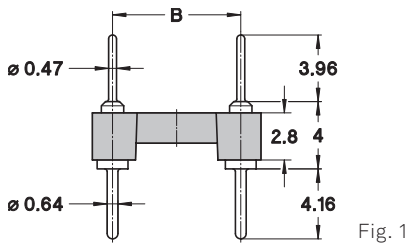

Fig. 1

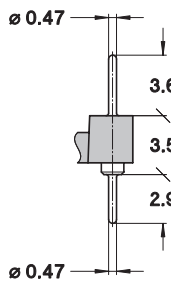

Fig. 2

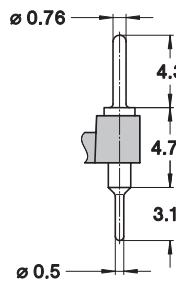

Fig. 3

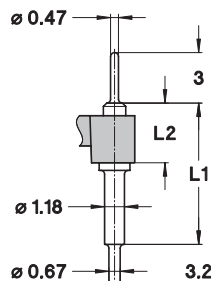
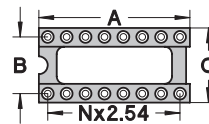

Fig. 4



| NO. OF POLES | A | B | C | SEE PAGE 128 | ORDER CODES |
|--------------|------|-------|------|--------------|----------------------|
| 10 | 12.6 | 5.08 | 7.6 | Fig. 1 | 15X-PP-210-00-XXX101 |
| 4 | 5.0 | 7.62 | 10.1 | Fig. 2 | 15X-PP-304-00-XXX101 |
| 6 | 7.6 | 7.62 | 10.1 | Fig. 3 | 15X-PP-306-00-XXX101 |
| 8 | 10.1 | 7.62 | 10.1 | Fig. 4 | 15X-PP-308-00-XXX101 |
| 10 | 12.6 | 7.62 | 10.1 | Fig. 5 | 15X-PP-310-00-XXX101 |
| 12 | 15.2 | 7.62 | 10.1 | Fig. 6 | 15X-PP-312-00-XXX101 |
| 14 | 17.7 | 7.62 | 10.1 | Fig. 7 | 15X-PP-314-00-XXX101 |
| 16 | 20.3 | 7.62 | 10.1 | Fig. 8 | 15X-PP-316-00-XXX101 |
| 18 | 22.8 | 7.62 | 10.1 | Fig. 9 | 15X-PP-318-00-XXX101 |
| 20 | 25.3 | 7.62 | 10.1 | Fig. 10 | 15X-PP-320-00-XXX101 |
| 22 | 27.8 | 7.62 | 10.1 | Fig. 11 | 15X-PP-322-00-XXX101 |
| 24 | 30.4 | 7.62 | 10.1 | Fig. 12 | 15X-PP-324-00-XXX101 |
| 28 | 35.5 | 7.62 | 10.1 | Fig. 13 | 15X-PP-328-00-XXX101 |
| 20 | 25.4 | 10.16 | 12.6 | Fig. 14 | 15X-PP-420-00-XXX101 |
| 22 | 27.8 | 10.16 | 12.6 | Fig. 15 | 15X-PP-422-00-XXX101 |
| 24 | 30.4 | 10.16 | 12.6 | Fig. 16 | 15X-PP-424-00-XXX101 |
| 28 | 35.5 | 10.16 | 12.6 | Fig. 17 | 15X-PP-428-00-XXX101 |
| 32 | 40.6 | 10.16 | 12.6 | Fig. 18 | 15X-PP-432-00-XXX101 |
| 10 | 12.7 | 15.24 | 17.7 | Fig. 19 | 15X-PP-610-00-XXX101 |
| 24 | 30.5 | 15.24 | 17.7 | Fig. 20 | 15X-PP-624-00-XXX101 |
| 28 | 35.5 | 15.24 | 17.7 | Fig. 21 | 15X-PP-628-00-XXX101 |
| 32 | 40.6 | 15.24 | 17.7 | Fig. 22 | 15X-PP-632-00-XXX101 |
| 36 | 45.7 | 15.24 | 17.7 | Fig. 23 | 15X-PP-636-00-XXX101 |
| 40 | 50.8 | 15.24 | 17.7 | Fig. 24 | 15X-PP-640-00-XXX101 |
| 42 | 53.3 | 15.24 | 17.7 | Fig. 25 | 15X-PP-642-00-XXX101 |
| 48 | 60.9 | 15.24 | 17.7 | Fig. 26 | 15X-PP-648-00-XXX101 |
| 50 | 63.5 | 15.24 | 17.7 | Fig. 27 | 15X-PP-650-00-XXX101 |
| 52 | 66.0 | 15.24 | 17.7 | Fig. 28 | 15X-PP-652-00-XXX101 |
| 50 | 63.5 | 22.86 | 25.3 | Fig. 29 | 15X-PP-950-00-XXX101 |
| 52 | 66.0 | 22.86 | 25.3 | Fig. 30 | 15X-PP-952-00-XXX101 |
| 64 | 81.2 | 22.86 | 25.3 | Fig. 31 | 15X-PP-964-00-XXX101 |

AVAILABLE VERSIONS

STANDARD HEADER

| | |
|----------------|------------|
| 150-...-001101 | See Fig. 1 |
| 150-...-006101 | See Fig. 2 |
| 150-...-018101 | See Fig. 3 |

INTERCONNECT HEADER

| | |
|----------------|------------|
| 151-...-XXX101 | See Fig. 4 |
|----------------|------------|

CONTACT LENGTH

| L1 (mm) | L2 (mm) | XXX CODE |
|---------|---------|----------|
| 6.2 | 4.7 | 003 |
| 8.4 | 3.55 | 004 |
| 15.3 | 3.55 | 005 |
| 21.2 | 3.55 | 016 |
| 27.4 | 3.55 | 017 |

Other lengths on request



preci-dip

WWW.PRECIDIP.COM TEL +41 32 421 04 00 SALES@PRECIDIP.COM

DUAL-IN-LINE PIN HEADERS

OPEN FRAME / SURFACE MOUNT

Specially designed for reflow soldering including vapor phase with male contacts pluggable into standard socket contacts and gull wing terminations.

TECHNICAL SPECIFICATIONS (FOR GENERAL SPECS, SEE PAGE 127)

| | |
|---------------------|--|
| INSULATOR | Black glass filled polyester PCT-GF30-FR |
| FLAMMABILITY | UL 94V-0 |
| CONTACT | Brass CuZn36Pb3 (C36000) |
| CONNECTING PIN Ø | 0.47 mm |
| MECHANICAL LIFE | Min. 100 cycles |
| RATED CURRENT | 1 A |
| DIELECTRIC STRENGTH | Min. 1'000 V _{RMS} |
| COPLANARITY | |
| SMD TERMINATIONS | Max. 0.10 mm |

ORDERING INFORMATION ROHS COMPLIANT PARTS

| PP PLATING CODE | TERMINATION | CONNECTING PIN |
|-----------------|--------------|----------------|
| 10 | 0.25 µm gold | 0.25 µm gold |
| 80 | Tin | Tin |
| V3 | Tin | 0.75 µm gold |

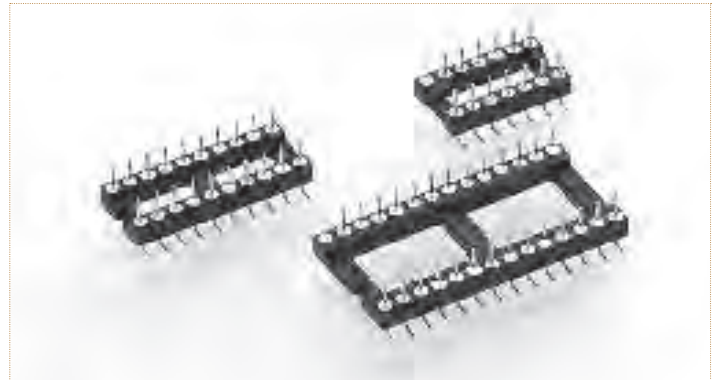

Other plating on request (see page 178 for plating specs).

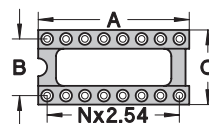
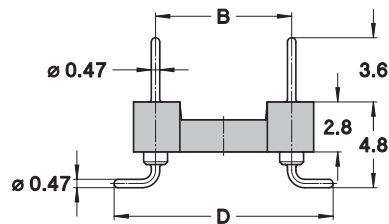

| NO. OF POLES | A | B | C | D | SEE PAGE 128 | ORDER CODES |
|--------------|------|-------|------|-------|--------------|----------------------|
| 10 | 12.6 | 5.08 | 7.6 | 9.76 | Fig. 1 | 150-PP-210-00-106101 |
| 4 | 5.0 | 7.62 | 10.1 | 12.30 | Fig. 2 | 150-PP-304-00-106101 |
| 6 | 7.6 | 7.62 | 10.1 | 12.30 | Fig. 3 | 150-PP-306-00-106101 |
| 8 | 10.1 | 7.62 | 10.1 | 12.30 | Fig. 4 | 150-PP-308-00-106101 |
| 10 | 12.6 | 7.62 | 10.1 | 12.30 | Fig. 5 | 150-PP-310-00-106101 |
| 12 | 15.2 | 7.62 | 10.1 | 12.30 | Fig. 6 | 150-PP-312-00-106101 |
| 14 | 17.7 | 7.62 | 10.1 | 12.30 | Fig. 7 | 150-PP-314-00-106101 |
| 16 | 20.3 | 7.62 | 10.1 | 12.30 | Fig. 8 | 150-PP-316-00-106101 |
| 18 | 22.8 | 7.62 | 10.1 | 12.30 | Fig. 9 | 150-PP-318-00-106101 |
| 20 | 25.3 | 7.62 | 10.1 | 12.30 | Fig. 10 | 150-PP-320-00-106101 |
| 22 | 27.8 | 7.62 | 10.1 | 12.30 | Fig. 11 | 150-PP-322-00-106101 |
| 24 | 30.4 | 7.62 | 10.1 | 12.30 | Fig. 12 | 150-PP-324-00-106101 |
| 28 | 35.5 | 7.62 | 10.1 | 12.30 | Fig. 13 | 150-PP-328-00-106101 |
| 20 | 25.4 | 10.16 | 12.6 | 14.84 | Fig. 14 | 150-PP-420-00-106101 |
| 22 | 27.8 | 10.16 | 12.6 | 14.84 | Fig. 15 | 150-PP-422-00-106101 |
| 24 | 30.4 | 10.16 | 12.6 | 14.84 | Fig. 16 | 150-PP-424-00-106101 |
| 28 | 35.5 | 10.16 | 12.6 | 14.84 | Fig. 17 | 150-PP-428-00-106101 |
| 32 | 40.6 | 10.16 | 12.6 | 14.84 | Fig. 18 | 150-PP-432-00-106101 |
| 24 | 30.5 | 15.24 | 17.7 | 19.92 | Fig. 20 | 150-PP-624-00-106101 |
| 28 | 35.5 | 15.24 | 17.7 | 19.92 | Fig. 21 | 150-PP-628-00-106101 |
| 32 | 40.6 | 15.24 | 17.7 | 19.92 | Fig. 22 | 150-PP-632-00-106101 |
| 36 | 45.7 | 15.24 | 17.7 | 19.92 | Fig. 23 | 150-PP-636-00-106101 |
| 40 | 50.8 | 15.24 | 17.7 | 19.92 | Fig. 24 | 150-PP-640-00-106101 |
| 42 | 53.3 | 15.24 | 17.7 | 19.92 | Fig. 25 | 150-PP-642-00-106101 |
| 48 | 60.9 | 15.24 | 17.7 | 19.92 | Fig. 26 | 150-PP-648-00-106101 |

PCB LAYOUT

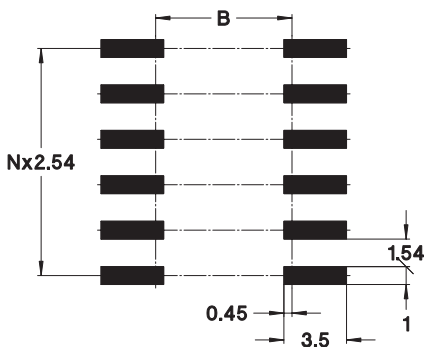



preci-dip

WWW.PRECIDIP.COM TEL +41 32 421 04 00 SALES@PRECIDIP.COM

DUAL-IN-LINE HEADERS

OPEN FRAME / SURFACE MOUNT PICK AND PLACE

Specially designed for reflow soldering including vapor phase with male contact pluggable into standard socket contacts.

TECHNICAL SPECIFICATIONS (FOR GENERAL SPECS, SEE PAGE 127)

| | |
|---------------------|--|
| INSULATOR | Black glass filled polyester PCT-GF30-FR |
| FLAMMABILITY | UL 94V-0 |
| CONTACT | Brass CuZn36Pb3 (C36000) |
| CONNECTING PIN Ø | 0.47 mm |
| MECHANICAL LIFE | Min. 100 cycles |
| RATED CURRENT | 1 A |
| DIELECTRIC STRENGTH | Min. 1'000 V _{RMS} |
| COPLANARITY | |
| SMD TERMINATIONS | Max. 0.10 mm |

ORDERING INFORMATION ROHS COMPLIANT PARTS

| PP PLATING CODE | TERMINATION | CONNECTING PIN |
|-----------------|--------------|----------------|
| 10 | 0.25 µm gold | 0.25 µm gold |
| 80 | Tin | Tin |
| V3* | Tin | 0.75 µm gold |

*only for 150-PP-XXX-00-106161

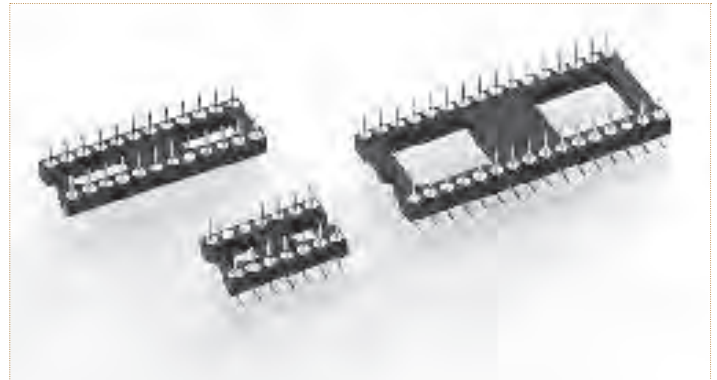

Other plating on request (see page 178 for plating specs).

Tape & Reel packaging:

replace 161 by suffix 191 to part number

Other pin counts please consult.



T & R Packaging

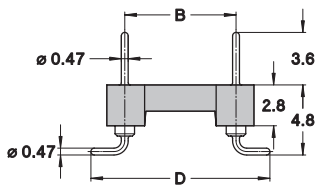

INSULATOR

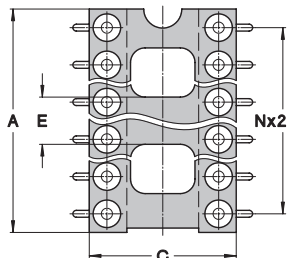

PCB LAYOUT

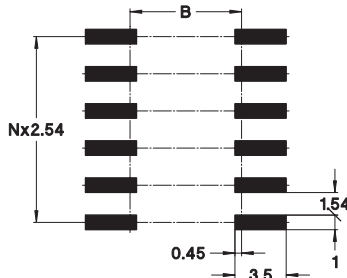

HEADER WITH GULL-WING TERMINATION

| NO. OF POLES | A | B | C | D | E | ORDER CODES |
|--------------|------|-------|------|-------|------|----------------------|
| 6 | 7.6 | 7.62 | 10.1 | 12.30 | 7.6 | 150-PP-306-00-106161 |
| 8 | 10.1 | 7.62 | 10.1 | 12.30 | 10.1 | 150-PP-308-00-106161 |
| 10 | 12.6 | 7.62 | 10.1 | 12.30 | 12.6 | 150-PP-310-00-106161 |
| 14 | 17.8 | 7.62 | 10.1 | 12.30 | 5.3 | 150-PP-314-00-106161 |
| 16 | 20.3 | 7.62 | 10.1 | 12.30 | 5.3 | 150-PP-316-00-106161 |
| 18 | 22.9 | 7.62 | 10.1 | 12.30 | 5.3 | 150-PP-318-00-106161 |
| 20 | 25.4 | 7.62 | 10.1 | 12.30 | 8.3 | 150-PP-320-00-106161 |
| 24 | 30.4 | 7.62 | 10.1 | 12.30 | 8.3 | 150-PP-324-00-106161 |
| 28 | 35.6 | 7.62 | 10.1 | 12.30 | 8.3 | 150-PP-328-00-106161 |
| 28 | 35.5 | 15.24 | 17.7 | 19.22 | 10.0 | 150-PP-628-00-106161 |
| 32 | 40.6 | 15.24 | 17.7 | 19.22 | 10.0 | 150-PP-632-00-106161 |
| 40 | 50.8 | 15.24 | 17.7 | 19.22 | 10.0 | 150-PP-640-00-106161 |
| 42 | 53.4 | 15.24 | 17.7 | 19.22 | 10.0 | 150-PP-642-00-106161 |

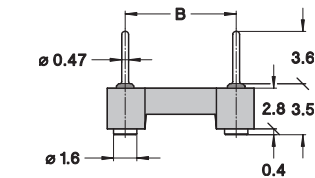

INSULATOR

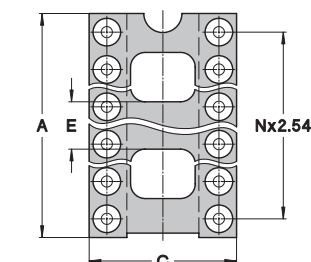

PCB LAYOUT

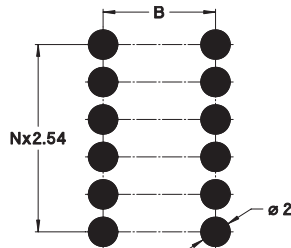

HEADER WITH FLOATING PIN TERMINATION

| NO. OF POLES | A | B | C | D | E | ORDER CODES |
|--------------|------|-------|------|-------|------|----------------------|
| 6 | 7.6 | 7.62 | 10.1 | 12.30 | 7.6 | 150-PP-306-01-899161 |
| 8 | 10.1 | 7.62 | 10.1 | 12.30 | 10.1 | 150-PP-308-01-899161 |
| 10 | 12.6 | 7.62 | 10.1 | 12.30 | 12.6 | 150-PP-310-01-899161 |
| 14 | 17.8 | 7.62 | 10.1 | 12.30 | 5.3 | 150-PP-314-01-899161 |
| 16 | 20.3 | 7.62 | 10.1 | 12.30 | 5.3 | 150-PP-316-01-899161 |
| 18 | 22.9 | 7.62 | 10.1 | 12.30 | 5.3 | 150-PP-318-01-899161 |
| 20 | 25.4 | 7.62 | 10.1 | 12.30 | 8.3 | 150-PP-320-01-899161 |
| 24 | 30.4 | 7.62 | 10.1 | 12.30 | 8.3 | 150-PP-324-01-899161 |
| 28 | 35.6 | 7.62 | 10.1 | 12.30 | 8.3 | 150-PP-328-01-899161 |
| 28 | 35.5 | 15.24 | 17.7 | 19.22 | 10.0 | 150-PP-628-01-899161 |
| 32 | 40.6 | 15.24 | 17.7 | 19.22 | 10.0 | 150-PP-632-01-899161 |
| 40 | 50.8 | 15.24 | 17.7 | 19.22 | 10.0 | 150-PP-640-01-899161 |
| 42 | 53.4 | 15.24 | 17.7 | 19.22 | 10.0 | 150-PP-642-01-899161 |



preci-dip

WWW.PRECIDIP.COM TEL +41 32 421 04 00 SALES@PRECIDIP.COM

DUAL-IN-LINE HEADERS

SLOTTED HEAD / TURRET / SOLDER CUP / OPEN FRAME / SOLDER TAIL

DIL headers for wiring applications.

TECHNICAL SPECIFICATIONS (FOR GENERAL SPECS, SEE PAGE 127)

| | |
|----------------------------|--|
| INSULATOR | Black glass filled polyester PCT-GF30-FR |
| FLAMMABILITY | UL 94V-0 |
| CONTACT | Brass CuZn36Pb3 (C36000) |
| CONNECTING PIN Ø | 0.5 mm |
| MECHANICAL LIFE | Min. 100 cycles |
| RATED CURRENT | 1 A |
| DIELECTRIC STRENGTH | Min. 1'000 V _{RMS} |

ORDERING INFORMATION ROHS COMPLIANT PARTS

| PP PLATING CODE | TERMINATION | CONNECTING PIN |
|-----------------|--------------|----------------|
| 10 | 0.25 µm gold | 0.25 µm gold |
| 80 | Tin | Tin |



Other plating on request (see page 178 for plating specs).
For complete part number replace **XX** with the code given below left.

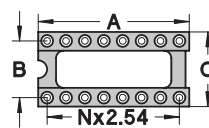
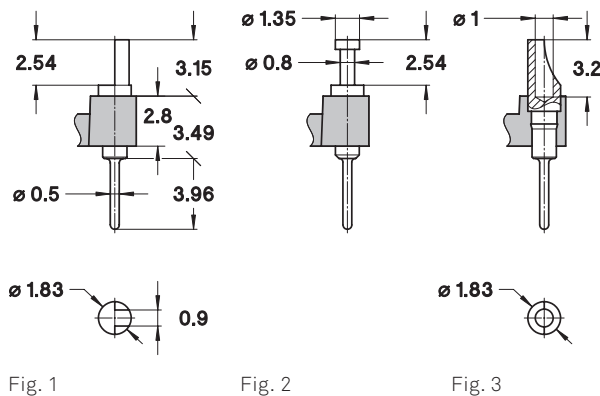

| NO. OF POLES | A | B | C | SEE PAGE 128 | ORDER CODES |
|--------------|------|-------|------|--------------|----------------------|
| 10 | 12.6 | 5.08 | 7.6 | Fig. 1 | 1XX-PP-210-00-001101 |
| 4 | 5.0 | 7.62 | 10.1 | Fig. 2 | 1XX-PP-304-00-001101 |
| 6 | 7.6 | 7.62 | 10.1 | Fig. 3 | 1XX-PP-306-00-001101 |
| 8 | 10.1 | 7.62 | 10.1 | Fig. 4 | 1XX-PP-308-00-001101 |
| 10 | 12.6 | 7.62 | 10.1 | Fig. 5 | 1XX-PP-310-00-001101 |
| 12 | 15.2 | 7.62 | 10.1 | Fig. 6 | 1XX-PP-312-00-001101 |
| 14 | 17.7 | 7.62 | 10.1 | Fig. 7 | 1XX-PP-314-00-001101 |
| 16 | 20.3 | 7.62 | 10.1 | Fig. 8 | 1XX-PP-316-00-001101 |
| 18 | 22.8 | 7.62 | 10.1 | Fig. 9 | 1XX-PP-318-00-001101 |
| 20 | 25.3 | 7.62 | 10.1 | Fig. 10 | 1XX-PP-320-00-001101 |
| 22 | 27.8 | 7.62 | 10.1 | Fig. 11 | 1XX-PP-322-00-001101 |
| 24 | 30.4 | 7.62 | 10.1 | Fig. 12 | 1XX-PP-324-00-001101 |
| 28 | 35.5 | 7.62 | 10.1 | Fig. 13 | 1XX-PP-328-00-001101 |
| 20 | 25.4 | 10.16 | 12.6 | Fig. 14 | 1XX-PP-420-00-001101 |
| 22 | 27.8 | 10.16 | 12.6 | Fig. 15 | 1XX-PP-422-00-001101 |
| 24 | 30.4 | 10.16 | 12.6 | Fig. 16 | 1XX-PP-424-00-001101 |
| 28 | 35.5 | 10.16 | 12.6 | Fig. 17 | 1XX-PP-428-00-001101 |
| 32 | 40.6 | 10.16 | 12.6 | Fig. 18 | 1XX-PP-432-00-001101 |
| 10 | 12.7 | 15.24 | 17.7 | Fig. 19 | 1XX-PP-610-00-001101 |
| 24 | 30.5 | 15.24 | 17.7 | Fig. 20 | 1XX-PP-624-00-001101 |
| 28 | 35.5 | 15.24 | 17.7 | Fig. 21 | 1XX-PP-628-00-001101 |
| 32 | 40.6 | 15.24 | 17.7 | Fig. 22 | 1XX-PP-632-00-001101 |
| 36 | 45.7 | 15.24 | 17.7 | Fig. 23 | 1XX-PP-636-00-001101 |
| 40 | 50.8 | 15.24 | 17.7 | Fig. 24 | 1XX-PP-640-00-001101 |
| 42 | 53.3 | 15.24 | 17.7 | Fig. 25 | 1XX-PP-642-00-001101 |
| 48 | 60.9 | 15.24 | 17.7 | Fig. 26 | 1XX-PP-648-00-001101 |
| 50 | 63.5 | 15.24 | 17.7 | Fig. 27 | 1XX-PP-650-00-001101 |
| 52 | 66.0 | 15.24 | 17.7 | Fig. 28 | 1XX-PP-652-00-001101 |
| 50 | 63.5 | 22.86 | 25.3 | Fig. 29 | 1XX-PP-950-00-001101 |
| 52 | 66.0 | 22.86 | 25.3 | Fig. 30 | 1XX-PP-952-00-001101 |
| 64 | 81.2 | 22.86 | 25.3 | Fig. 31 | 1XX-PP-964-00-001101 |

AVAILABLE VERSIONS

Replace **1XX-...** in order code by

| ORDER CODE | DESCRIPTION | DIMENSIONS |
|------------|---|------------|
| 160 | Header with slotted head to accept wires or component leads | See Fig. 1 |
| 170 | Header with turret head | See Fig. 2 |
| 180 | Header with solder cup | See Fig. 3 |



preci-dip

WWW.PRECIDIP.COM TEL +41 32 421 04 00 SALES@PRECIDIP.COM

TO SOCKETS

SOLDER TAIL / SURFACE MOUNT

Sockets for packages with contacts arranged on .200" (5.08 mm) and .230" (5.84 mm) diameter acc. to JEDEC TO-Series outlines.

TECHNICAL SPECIFICATIONS (FOR GENERAL SPECS, SEE PAGE 127)

| | |
|--------------------------------|---|
| INSULATOR | Black glass filled polyester PCT-GF30-FR |
| FLAMMABILITY | UL 94V-0 |
| SLEEVE | Brass CuZn36Pb3 (C36000) |
| CONTACT CLIP (4 FINGER) | Beryllium copper (C17200) |
| ACCEPTED PIN Ø | 0.40 to 0.56 mm |
| FORCES | 2 N typ. insertion 1 N typ. withdrawal (polished steel gauge Ø 0.43 mm) |
| MECHANICAL LIFE | Min. 100 cycles |
| RATED CURRENT | 1 A |
| CONTACT RESISTANCE | Max. 10 mΩ |
| DIELECTRIC STRENGTH | Min. 1'000 V _{RMS} |



Other plating on request (see page 178 for plating specs).

ORDERING INFORMATION ROHS COMPLIANT PARTS

| | | |
|------------------------|---------------|--------------|
| PP PLATING CODE | SLEEVE | CLIP |
| 87 | Tin | Flash gold |
| 83 | Tin | 0.75 µm gold |

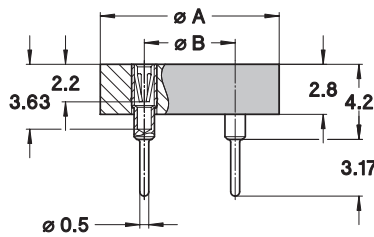

Fig. 1

SOCKETS, SOLDER TAIL, FIG. 1

| NO. OF POLES | A | B | SEE | ORDER CODES |
|--------------|------|------|--------|----------------------|
| 3 | 10.0 | 5.08 | Fig. 3 | 917-PP-103-41-005101 |
| 4 | 10.0 | 5.08 | Fig. 4 | 917-PP-104-41-005101 |
| 8 | 10.0 | 5.08 | Fig. 5 | 917-PP-108-41-005101 |
| 8 | 10.0 | 5.84 | Fig. 6 | 917-PP-208-41-005101 |
| 10 | 10.0 | 5.84 | Fig. 7 | 917-PP-210-41-005101 |

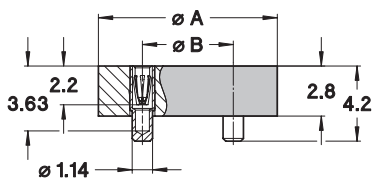

Fig. 2

SOCKETS, SMD MOUNT, FIG. 2

| NO. OF POLES | A | B | SEE | ORDER CODES |
|--------------|------|------|--------|----------------------|
| 3 | 10.0 | 5.08 | Fig. 3 | 917-PP-103-41-053101 |
| 4 | 10.0 | 5.08 | Fig. 4 | 917-PP-104-41-053101 |
| 8 | 10.0 | 5.08 | Fig. 5 | 917-PP-108-41-053101 |
| 8 | 10.0 | 5.84 | Fig. 6 | 917-PP-208-41-053101 |
| 10 | 10.0 | 5.84 | Fig. 7 | 917-PP-210-41-053101 |



T & R Packaging

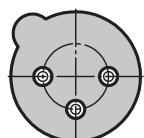

Fig. 3

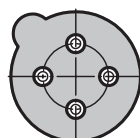

Fig. 4

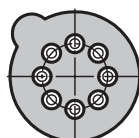

Fig. 5

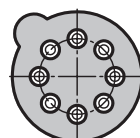

Fig. 6

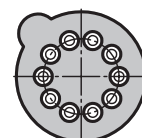

Fig. 7



Компания «ЭлектроПласт» предлагает заключение долгосрочных отношений при поставках импортных электронных компонентов на взаимовыгодных условиях!

Наши преимущества:

- Оперативные поставки широкого спектра электронных компонентов отечественного и импортного производства напрямую от производителей и с крупнейших мировых складов;
- Поставка более 17-ти миллионов наименований электронных компонентов;
- Поставка сложных, дефицитных, либо снятых с производства позиций;
- Оперативные сроки поставки под заказ (от 5 рабочих дней);
- Экспресс доставка в любую точку России;
- Техническая поддержка проекта, помощь в подборе аналогов, поставка прототипов;
- Система менеджмента качества сертифицирована по Международному стандарту ISO 9001;
- Лицензия ФСБ на осуществление работ с использованием сведений, составляющих государственную тайну;
- Поставка специализированных компонентов (Xilinx, Altera, Analog Devices, Intersil, Interpoint, Microsemi, Aeroflex, Peregrine, Syfer, Eurofarad, Texas Instrument, Miteq, Cobham, E2V, MA-COM, Hittite, Mini-Circuits, General Dynamics и др.);

Помимо этого, одним из направлений компании «ЭлектроПласт» является направление «Источники питания». Мы предлагаем Вам помощь Конструкторского отдела:

- Подбор оптимального решения, техническое обоснование при выборе компонента;
- Подбор аналогов;
- Консультации по применению компонента;
- Поставка образцов и прототипов;
- Техническая поддержка проекта;
- Защита от снятия компонента с производства.



Как с нами связаться

Телефон: 8 (812) 309 58 32 (многоканальный)

Факс: 8 (812) 320-02-42

Электронная почта: org@eplast1.ru

Адрес: 198099, г. Санкт-Петербург, ул. Калинина, дом 2, корпус 4, литера А.