

CJ1G/CJ1H CPUs Mean Optimized Performance



■ Features Enhancing Flexibility and Functionality

- 0.02 μs execution time per basic instruction.
- Ultra-compact design.
- Built-in flash memory for battery-free operation.
- Up to 64 MB of auxiliary flash memory available for many time-saving programming uses.
- The efficiency of transfers between the CPU and Special I/O Modules has been optimized, further improving overall system performance.
- Floating-point decimal numbers can be easily converted to ASCII character string data for display on an HMI (in the HMI's character string display objects).
- For process control applications, use the PID WITH AUTOTUNING instruction to calculate PID constants automatically. Using the limit cycle method for tuning, autotuning is completed quickly. This is particularly effective for multi-loop PID control.
- Built-in peripheral and RS-232 ports.

■ Basic CPU Specifications

Model	No. of I/O points	Max. number of modules, Max. No. of expansions	Program capacity	Data memory capacity (See note.)	LD instruction processing speed
CJ1H-CPU66H	2,560	40 modules, up to 3 expansion racks	120K steps	256K words (DM: 32K words, EM: 32K words x 7 banks)	0.02 μs
CJ1H-CPU65H			60K steps		
CJ1G-CPU45H	1,280	30 modules, up to 2 expansion racks	30K steps	128K words (DM: 32K words, EM: 32K words x 3 banks)	0.04 μs
CJ1G-CPU44H			20K steps		
CJ1G-CPU43H	960	30 modules, up to 2 expansion racks	20K steps	64K words (DM: 32K words, EM: 32K words x 1 bank)	
CJ1G-CPU42H			10K steps		

Note: The available data memory capacity is the sum of the Data Memory (DM) and the Extended Data Memory (EM).

CJ1M CPUs Offer Specialized Functionality



■ Special Functions

- Smallest CJ1 in physical size; CPU11, CPU12 and CPU13 are just 1 1/4" wide.
- Up to 64 MB auxiliary flash memory available for many time-saving programming uses.
- Serial PLC Link allows simple communication among 9 CJ1 PLCs (1 master, 8 slaves).
- Same instruction set as the larger CJ1G/H and CJ1H/H; the only difference is no EM available in the CJ1M.
- A Pulse I/O instruction takes advantage of positioning capabilities in CPU21, CPU22 and CPU23.
- Built-in high-speed counter in CPU21, CPU22 and CPU23.
- Easy terminal block connection for built-in I/O (CPU21, CPU22 and CPU23).
- CPU21, CPU22 and CPU23 have built-in pulse catch inputs which will detect pulses that are quicker than the CPU cycle time.
- Built-in peripheral and RS-232 ports.

■ Basic Specifications for CJ1M CPU Models

Model	No. of I/O points	Maximum number of modules, Max. No. of expansions	Program capacity	Data memory capacity	LD instruction processing speed
CJ1M-CPU11	160	10 modules, no expansion racks	5K steps	32K words (DM only, no EM)	0.1 μs
CJ1M-CPU12	320	10 modules, no expansion racks	10K steps		
CJ1M-CPU13	640	20 modules, 1 expansion rack	20K steps		
CJ1M-CPU21	160 (built-in, 10 in, 6 out)	10 modules, no expansion racks	5K steps		
CJ1M-CPU22	320 (built-in, 10 in, 6 out)	10 modules, no expansion racks	10K steps		
CJ1M-CPU23	640 (built-in, 10 in, 6 out)	20 modules, 1 expansion rack	20K steps		

■ Additional Specifications for Models CJ1M-CPU21/-CPU22/-CPU23

Item	Specifications
Built-in I/O function	Built in: 10 inputs, 6 outputs (can be configured as general-purpose or as specialized)
High-speed counter function	Single phase/up and down/pulse + direction input (60/100 kHz two settings)
	Differential phase input (30 kHz two settings)
High-speed pulse output function	Up and down/pulse + direction output (60/100 kHz two settings)
	PWM output (x2) for CPU22/CPU23 and (x1) for CPU21
Serial PLC Link function	Link up to 10 words between 9 PLCs (See page B-19.)

CJ1M CPUs Offer Specialized Functionality

■ Connectors for Built in I/O Terminal on CPU21/22/23

MIL Flat Cable Connector (40 Pin Pressure-fitted Connectors)

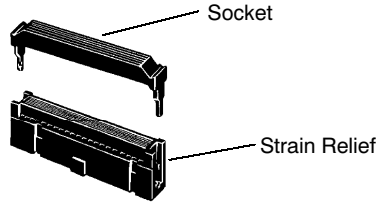

Item	Omron Model	3M Model	Daiichi Electronics Model
Socket	—	89140-0101	FRC5-A040-3T0N
Strain Relief	—	3448-89140	—
Set Model Number	XG4M-4030T	—	FRC5-A030-3T0S

MIL Loose Wire Crimp Connectors (40 Pin Pressure-fitted Connectors)

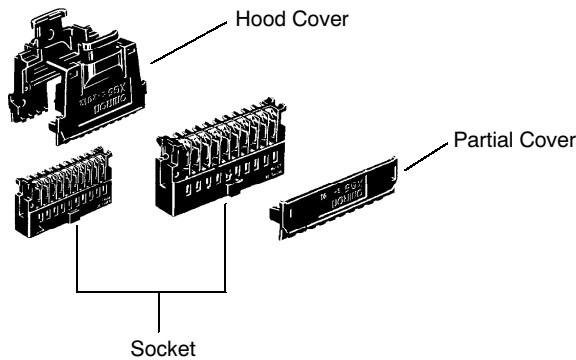

Item	Omron Model
Socket	AWG24 XG5M-4032-N
Hood Cover	XG5S-4022
Partial Cover (2 required for each socket)	XG5S-2001

■ Connecting Cables

Model	Cable Length (m)
XW2Z-100K	1.0
XW2Z-150K	1.5
XW2Z-200K	2.0
XW2Z-300K	3.0
XW2Z-500K	5.0

■ Connector Terminal Blocks

Model	Terminals	No. of Contacts
XW2B-40G4	M3 Screw Terminals	40
XW2B-40G5	M3.5 Screw Terminals	
XW2D-40G6	M3 Screw Terminals	

Pin No. Selections

40-Pin MIL Connector for I/O

Pin no.	Signal	Pin no.	Signal
1	CTIN0/INT0 (24V)	2	CTIN1/Z2/INT1 (24V)
3	CTIN0/INT0 (LD+)	4	CTIN1/Z2/INT1 (LD+)
5	CTIN0/INT0 (0V/LD-)	6	CTIN1/Z2/INT1 (0V/LD-)
7	CTIN2/Z1/INT (24V)	8	CTIN3/Z0/INT3 (24V)
9	CTIN2/Z1/INT2 (LD+)	10	CTIN3/Z0/INT3 (LD+)
11	CTIN2/Z1/INT2 (0V/LD-)	12	CTIN3/Z0/INT3 (0V/LD-)
13	CTIN4/A2 (24V)	14	CTIN5/B2 (24V)
15	CTIN4/A2 (LD+)	16	CTIN5/B2 (LD+)
17	CTIN4/A2 (0V/LD-)	18	CTIN5/B2 (0V/LD-)
19	CTIN6/A1 (24V)	20	CTIN7/B1 (24V)
21	CTIN6/A1 (LD+)	22	CTIN7/B1 (LD+)
23	CTIN6/A1 (0V/LD-)	24	CTIN7/B1 (0V/LD-)
25	CTIN8/A0 (24V)	26	CTIN9/B0 (24V)
27	CTIN8/A0 (LD+)	28	CTIN9/B0 (LD+)
29	CTIN8/A0 (0V/LD-)	30	CTIN9/B0 (0V/LD-)
31	POUT0/CW0/FEED0	32	POUT1/CCW0/FEED1
33	POUT2/CW1/DIR0	34	POUT3/CCW1/DIR1
35	POUT4/PWM0	36	POUT5/PWM1
37	Out + DC□24V□	38	out+DC□5V□

■ Cabling to Terminal Block Example

CJ1M-CPU2□

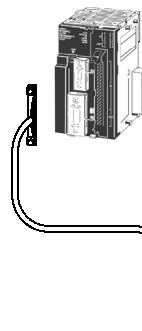

Connecting Cable for General Purpose I/O
XW2Z-□□0K

Note: When connecting to an Omron Servo, refer to this catalog's SMARTSTEP information found in the Special I/O section of this catalog.



Connector Terminal Block
XW2B-40G4
XW2B-40G5
XW2D-40G6

Additional Information: For more details and specifications on cables and terminal blocks, refer to manual No. W393 or the Wiring Solutions section.

CJ1M CPUs Offer Specialized Functionality

■ Connector to Wire Conversion Board

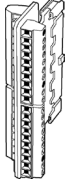

Item/Description	Appearance	Model
40 pin MIL Connector to Screw terminal I/Os conversion board.		CJ1M-BRKOUT

■ Serial PLC Link Accessories

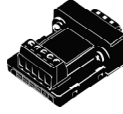
Item/Description	Appearance	Model
RS-232C to RS-422/485 Converter (Converts an RS-232C port to an RS-422/485 Port.) Used for Serial PLC Link with CJ1M. Mounts directly to the CPU.		CJ1W-CIF11

■ CPU Programming Cables for All CPU Types

Item	Model	Length	Specifications
Programming Device Connecting Cables (for Peripheral port)	CS1W-CN118	0.1 m	Connects DOS computer, D-Sub 9-pin receptacle (Converts between RS-232C cable and peripheral port)
	CS1W-CN226	2 m	Connects DOS computer, D-Sub 9-pin
	CS1W-CN626	6 m	Connects DOS computer, D-Sub 9-pin
Programming Device Connecting Cables (for RS-232C port)	C200H-CN229-EU	2 m	Connects DOS computer, D-Sub 9-pin

■ CJ1H-CPU□□H, CJ1G-CPU□□H and CJ1M-CPU1□

Memory Card Indicators

MCPWR (green): Lit when power is supplied to the Memory Card. BUSY (orange): Lit when Memory Card is being accessed.

Memory Card

Power Supply Switch

Press the power supply switch to disconnect power before removing the Memory Card. Press the Memory Card Power Supply Switch to perform an easy backup operation.

Memory Card

Memory Card Eject Button

Press the eject button to remove the Memory Card from the CPU.

Slider

Secures the neighboring Module.

Indicators



Peripheral Port

The peripheral port is connected to Programming Devices, such as Programming Consoles or host computers.

Connector

Connect to neighboring Module by joining Connectors.

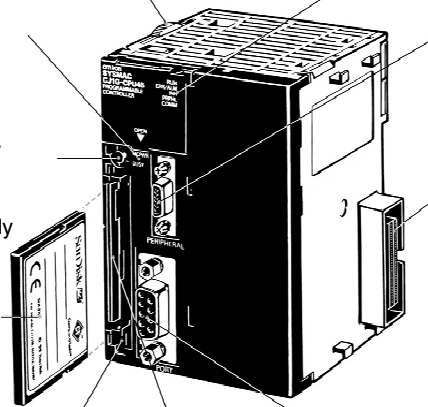

Memory Card Connector

RS-232C Port

The RS-232C port connects to Programming Devices other than Programming Consoles, host computers, general-purpose external devices, or Operator Interface Terminals.

■ CJ1M-CPU2□

Memory Card Indicators

MCPWR (green): Lit when power is supplied to the Memory Card. BUSY (orange): Lit when Memory Card is being accessed.

Memory Card

Power Supply Switch

Press the power supply switch to disconnect power before removing the Memory Card. Press the Memory Card Power Supply Switch to perform an easy backup operation.

Memory Card

Memory Card Eject Button

Press the eject button to remove the Memory Card from the CPU.

Slider

Secures the neighboring Module.

Indicators

Peripheral Port

The peripheral port is connected to Programming Devices, such as Programming Consoles or host computers.

Connector

Connect to neighboring Module by joining Connectors.

40-Pin connector

10 inputs and 6 outputs integrate to the CJ1M-CPU22 and CPU 23 only. *Inputs:* 4 interrupt inputs (pulse catch); 2 high-speed counter inputs (phase differential: 50 kHz; single phase: 100 kHz). *Outputs:* 2 pulse outputs (2 points for positioning, 100-kHz speed control, or PWM output)

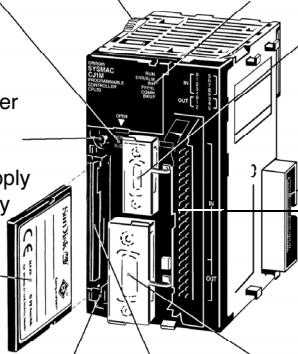

Memory Card Connector

RS-232C Port

The RS-232C port connects to Programming Devices other than Programming Consoles, host computers, general-purpose external devices, or Operator Interface Terminals.

Optimum Speed and Processing Capabilities

Advanced Machine Performance with High-Speed Processing

- With a large program, memory and I/O capacity, CJ1 CPUs offer high-speed instructions and peripheral servicing.
- CJ1 Series PLCs provide optimum speed for advanced control, communications, and data processing.

Execution Times from 20 ns

Fast instruction processing includes 0.02 μ s for LD and 0.18 μ s for MOV. And special instructions are processed almost as fast as basic ones (e.g., as fast as 0.18 μ s for some instructions).

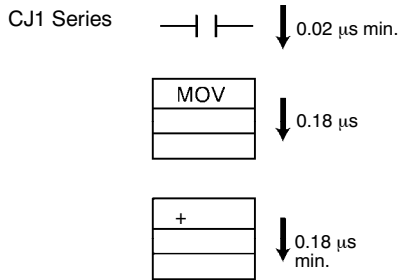

Extremely Fast Peripheral Servicing and I/O Refresh Speed

- Refresh time for CJ1 Series 64-point Input Modules: 0.012 ms
- Refresh time for CJ1 Series 64-point Output Modules: 0.015 ms
- Refresh time for 256 words for Communications Modules: 0.45 ms

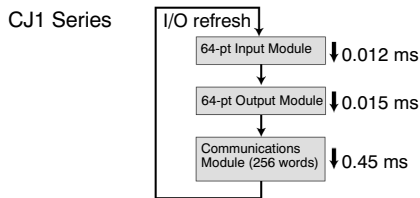

30 Times the Overall Cycle Speed

The following examples are for 30K-step programs as compared with previous PLC models.

- Basic instructions: 50%
- MOV instructions: 30%
- Arithmetic operation instructions: 20%

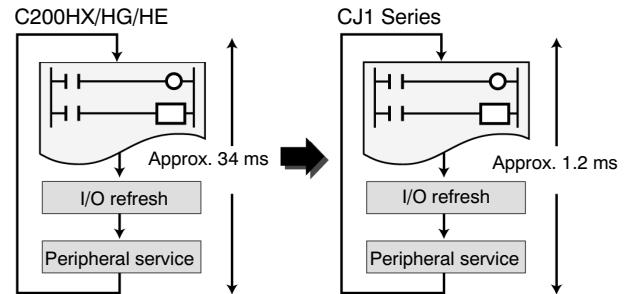

Large Capacities Fit the Application

CJ1 Series CPUs also provide ample capacity for advanced machine interfaces, communications, and data processing.

Program Capacity

Create programs with up to 120K steps.

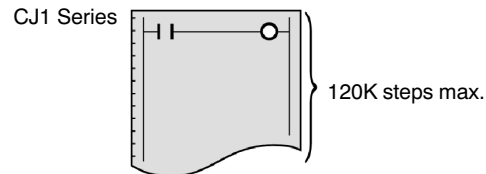

I/O Capacity

Handle up to 2,560 I/O points.

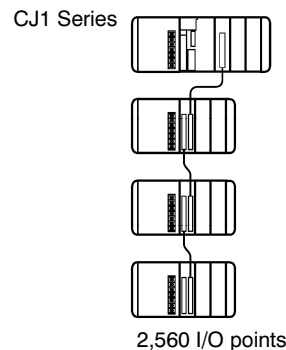

Performance Flexibility and Expansion Capabilities

Data Memory

Use up to 256K words of data memory (word data).

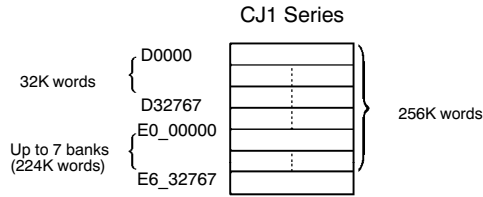

Number of Timers/Counters

Program up to 4,096 timers and 4,096 counters.

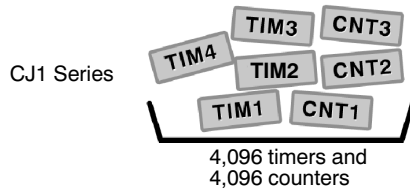

A Wide Variety of Instructions

- Text string processing.
- FIFO and LIFO and record processing for table data.
- File memory processing.
- Repeat processing (FOR/NEXT).
- Command send (CMND).
- Index register processing.
- High-speed transfers.
- Floating-point decimal.
- Bit sets/resets.
- Stack data processing.
- Single-precision floating-point decimal comparisons.
- Character string-precision floating-point decimal conversions.
- Double-precision floating-point decimal conversions and calculations.
- PID with autotuning.
- Global subroutines.
- CPU Bus Module refreshing, and more.

CJ1M Models Also Support These Instructions

- Origin Search (ORG).
- Acceleration/Deceleration control.
- High-Speed Counter Present Value Read.

Up to 3 Expansion Racks

System expansion can be achieved by simply adding an I/O Control Module, which will allow expansion up to three racks. A cable will connect from the I/O Control Module in the master rack to an I/O Interface Module in each of Expansion Racks. At full capacity a CJ1 can have 4 total Racks (including the Master) each configured with 10 Modules apiece, making a total of 40 I/O Modules.

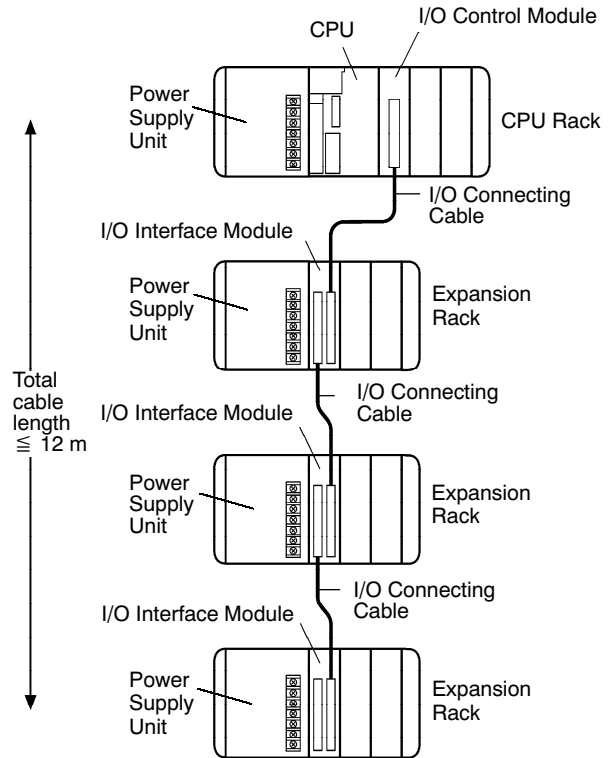

Complete Compatibility with CS1 Series Software

The same software resources (e.g., programs) can be used to program the CJ1 as previously used with the CS1 Series, enabling easy standardization on software at all levels.

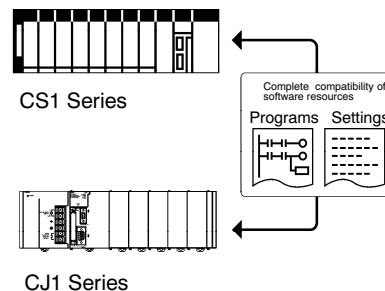

Outstanding Connectivity and Compatibility

■ Protocol List

The following protocols are supported for serial communications.

Protocol	Main destinations	Outline	Commands/Instructions
Host Link (SYSMAC WAY)	Computers, OMRON Operator Interface Terminals	Communications between host computers and PLCs	Host Link commands or FINS commands (unsolicited messages supported)
Custom	General-purpose devices	Custom communications with general-purpose external devices	TXD and RXD instructions
Protocol Macros	General-purpose devices (including OMRON components)	Sending/receiving messages (communications frames) matched to the communications specifications of external devices	PMCR instruction
1:N NT Links	OMRON Operator Interface Terminals	High-speed communications using direct access with Programmable Terminals (High-speed links: NS Series and NT631/NT31 "-V2" models only.)	None
Peripheral bus	Support Software	Communications with Support Software tools running on host computers	None

Note: To determine the ports that can be used for each protocol, refer to "Serial Communications" in the *Industrial Networking and Communications* Section of this catalog.

Overview of Serial Link Communications

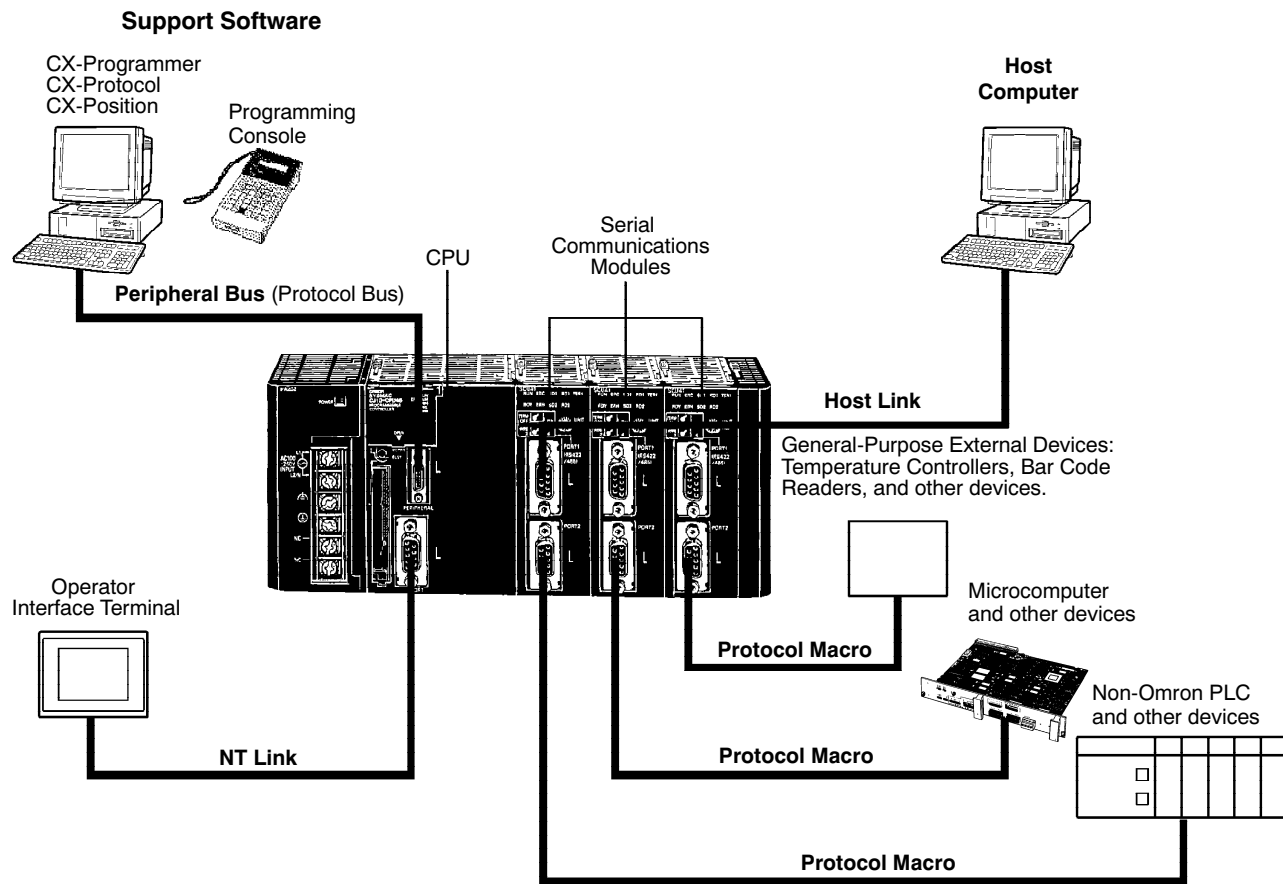

Serial PLC Link Communications

Simple PLC Link provides a quick and easy-to-understand data link among up to 9 nodes on a serial network. Each node is allocated 10 words of data, and two methods of sharing the data are user-selectable. An Omron Operator Interface Terminal can be used on this network where it counts as one slave node.

Features

- Capabilities: 10 words per PLC can be allocated to PLC Link in a master/slave arrangement.
- Network size: 1 master and 1 to 8 slaves (total of 9 CJ1 PLCs) can exchange data.
- Medium: RS-232, using port built into each CPU.
- Hardware: CJ1W-CIF11 RS-232C to RS-422/485 converter for multi-drop.

All Node Link Method

All Node Link Method shares the information from all nodes with all the connected nodes.

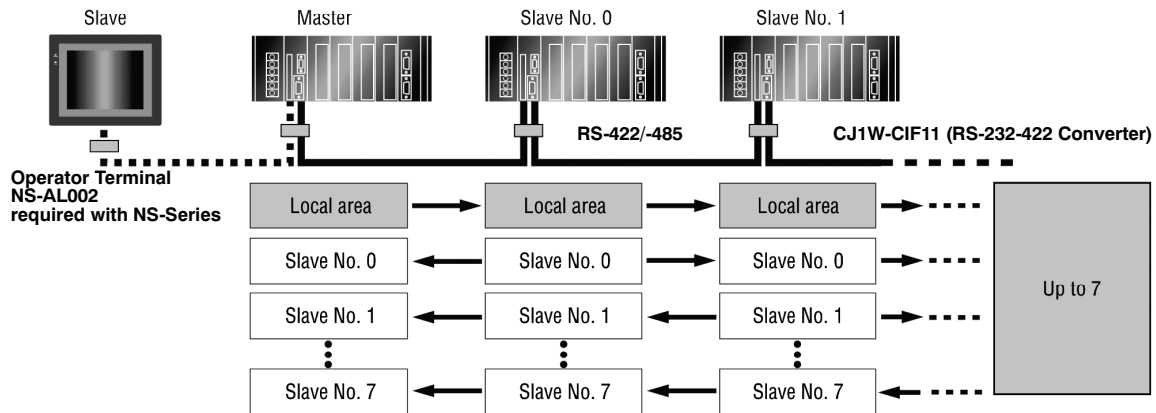

Master Link Method

Master Link Method shares only the master's 10 words with all the other nodes, and the master receives data from all the nodes.

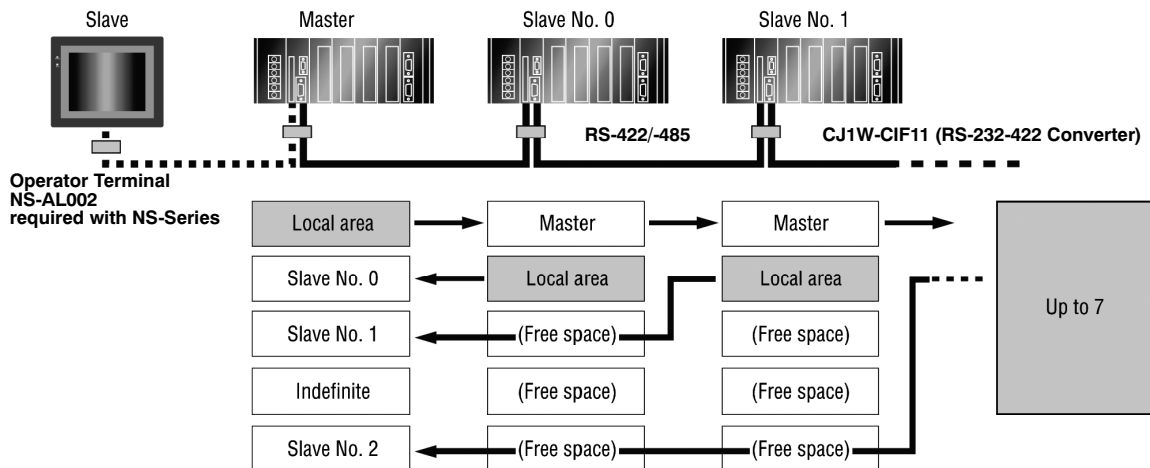

Memory Cards

■ Optional Program, Recipe and Data Storage

- Make fast production changeovers; store a recipe or controller program on memory cards to restart with the new parameters without connection to a computer.
- Update machine programs in the field at low cost without a service call from engineering or technicians by sending a memory card.
- Store production data by shift on memory cards in CSV or text format for later analysis of productivity using Microsoft Excel.
- After power outage or maintenance, restart machine from a memory card to eliminate concerns of program corruption.



■ Flash Memory Cards

Item	Model	Specifications
Flash Memory Cards	HMC-EF172	15 MB
	HMC-EF372	30 MB
	HMC-EF672	64 MB
Memory Card Adapter	HMC-AP001	Mounts a memory card to fit the PCMCIA card slot on a computer

■ Memory Card Applications

Use Windows Files to Manipulate the PLC File Data

- Program standardization
- System startup
- File transfer

The user program, parameters, I/O memory, names, I/O comments, and block comments can all be handled as file data. File data can be used to standardize programs and initialization data for each system, and comments can be stored as file data on Memory Cards.

CX-Programmer or a Programming Console can be connected to a CJ1 PLC to transfer files between the CPU's memory and Memory Cards (or EM File Memory).

As with Windows files, file icons can be dragged and dropped to a Memory Card or computer storage device to copy the files (FTP) easily.

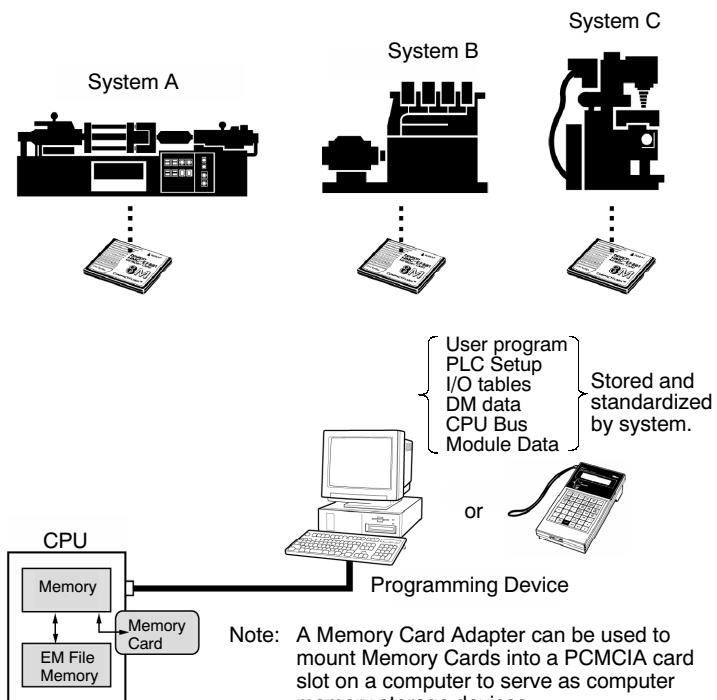

More Memory Card Applications

Utilize a Programming Console to Manage Data Onsite

A Programming console can be connected to the PLC to transfer files between the Memory cards and the CPU's memory (or EM File Memory). A Programming console and Memory Card are all you need to change data onsite.

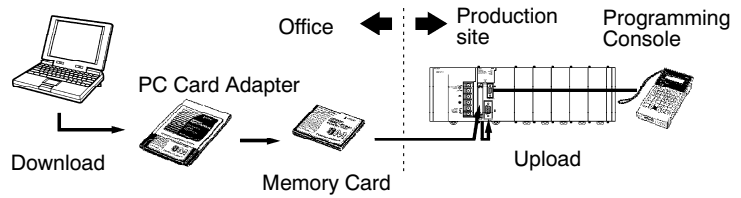

Change the Program by Simply Changing Cards

File data can be automatically transferred from Memory Card to the CPU when power is turned ON, enabling Memory Cards to be used for operation in the same way as with ROM.

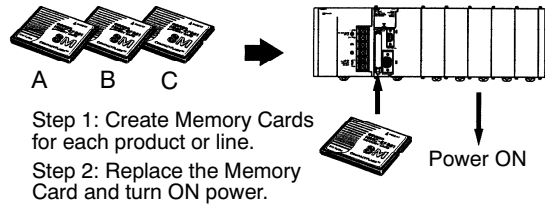

Manipulate Files During Operation

File read and write instructions can be used during operation to transfer files between the CPU's memory and Memory Cards (or EM File Memory). Trend data, quality control data, and other data from memory can be stored during operation in Memory Cards or EM File Memory.

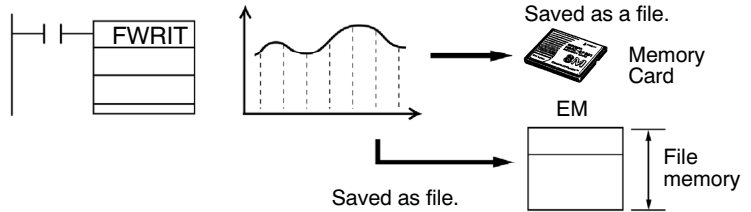

Maintenance and Management

■ A Wide Range of Special Functions

Cycle Time Functions

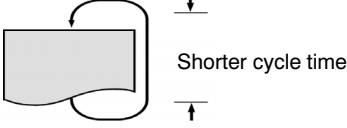
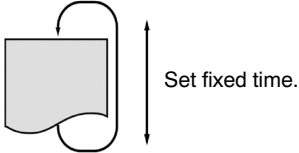
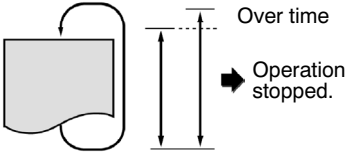
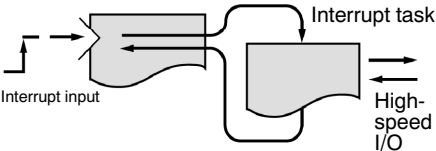
Requirements	Solutions
Reducing the cycle time 	<ul style="list-style-type: none"> Place tasks that are not being executed on standby. Create subroutines for portions of tasks executed only under special conditions. Disable cyclic refreshing for Special I/O Modules when not required in each cycle.
Eliminating deviations in I/O response time 	<ul style="list-style-type: none"> Set the cycle time to a fixed time.
Stopping operation for long cycle times 	<ul style="list-style-type: none"> Use the cycle time monitoring function to stop operation when the cycle time is too long. (Functions as a cycle-time watch-dog timer.)
Reducing I/O response time for specific I/O 	<ul style="list-style-type: none"> Use an I/O interrupt task to execute an interrupt program when a specific input turns ON. When the appropriate instruction is executed in the interrupt program the external I/O will be refreshed. External I/O can be directly refreshed either by using immediate refreshing for instruction operands or by using the IORF instruction to refresh all or a specified portion of external I/O.

Interrupt Functions

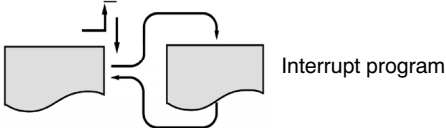
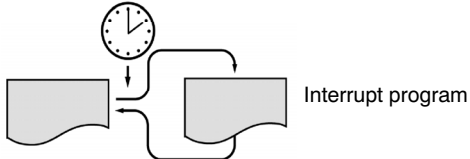
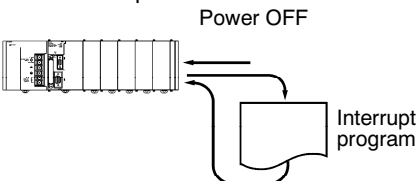
Requirements	Solutions
Executing program without being affected by the cycle time 	<ul style="list-style-type: none"> Use I/O interrupt tasks to execute interrupt programs when specific inputs turn ON.
Monitoring operating conditions at a specific interval 	<ul style="list-style-type: none"> Use a scheduled interrupt task to execute an interrupt program at a specific interval.
Executing emergency processing for power interruptions 	<ul style="list-style-type: none"> Use the power OFF interrupt task to execute an interrupt program before the CPU stops. Immediate refreshing can be used inside this interrupt program to refresh specified outputs.

■ Maintenance and Debugging Functions

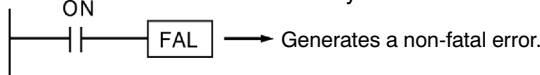
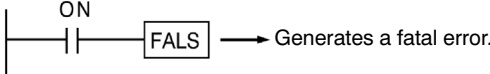
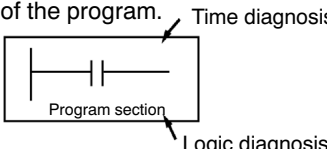
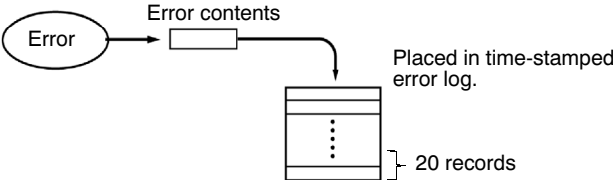
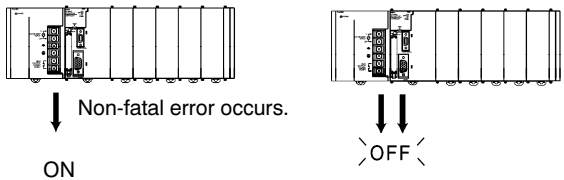
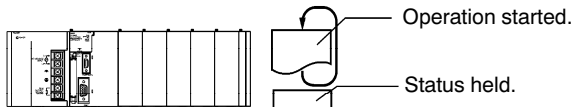
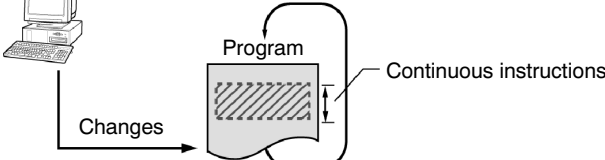
Requirements	Solutions
<p>Creating a user-defined error for specific conditions (e.g., errors or specific signals from the controlled system) but allowing the CPU to continue running.</p>	<ul style="list-style-type: none"> Use the FAL instruction to create a non-fatal user-defined error. An entry can also be left in the error history when the error occurs.  <ul style="list-style-type: none"> FAL can also be used just to leave error history records for specific conditions that are not necessarily errors.
<p>Creating a user-defined error for specific conditions (e.g., errors or specific signals from the controlled system) and stopping the CPU as a result.</p>	<ul style="list-style-type: none"> Use the FALS instruction to create a fatal user-defined error. An entry can also be left in the error history when the error occurs.  <ul style="list-style-type: none"> FALS can also be used to automatically stop operation for specific conditions that are not necessarily errors.
<p>Determining if a specific output turns ON within a specified time after an input turns ON. If the output does not turn ON, an error will be generated. Then the address in the program responsible for the output failing to turn on will be determined.</p>	<ul style="list-style-type: none"> Use the FPD instruction to perform time or logic diagnosis of a specified portion of the program. 
<p>Creating a history of user-defined and system errors that have occurred.</p>	<ul style="list-style-type: none"> Use the error log to record up to 20 time-stamped error records.
<p>Creating an external output when a non-fatal error occurs.</p>	<ul style="list-style-type: none"> Use the Non-fatal Error Flag. 
<p>Turning OFF all outputs from Output Modules for specific conditions.</p>	<ul style="list-style-type: none"> Use the Load OFF Bit. 
<p>Turning OFF all outputs from Output Modules during trial system operation.</p>	<p>ON</p> <p>OFF</p>
<p>Maintaining I/O memory status when starting operation.</p>	<ul style="list-style-type: none"> Use the I/O memory hold function to start program execution with the same I/O memory status as the last time the program was executed. 
<p>Correcting the program during operation (online editing).</p>	<ul style="list-style-type: none"> Use the CX-Programmer to change the program as required during operation. 

(This table continues on the next page.)

Maintenance and Management

Maintenance and Debugging Functions (continued)

Sampling specified I/O memory bits or word data.

- Scheduled sampling
- Sampling once per cycle
- User-defined sampling

• Use the data tracing function.

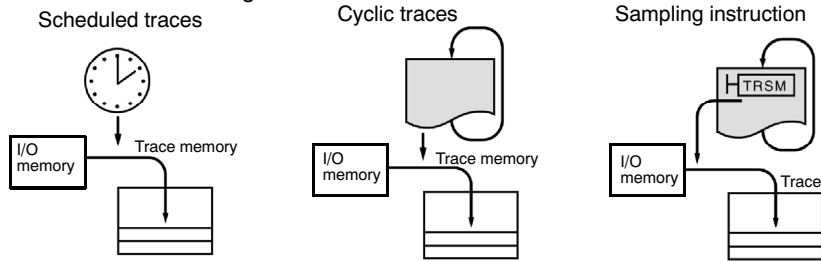

Remote Programming and Monitoring

Requirements	Solutions
Monitoring and editing online for remote PLCs via modem	<ul style="list-style-type: none"> • Perform online programming and monitoring from CX-Programmer running on a computer connected to the PLC via a modem.

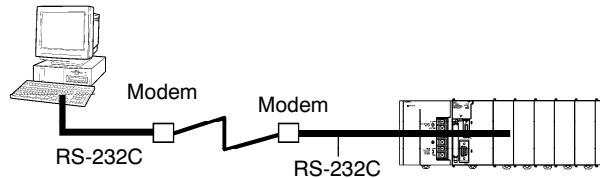

Monitoring and editing online from CX-Programmer for a remote PLC connected to a network

- Use a Serial Communications Module, connected to a PLC via a modem; use an instruction to switch to host link mode, and then program or monitor from CX-Programmer. (It's not necessary to cut the connection during the procedure.)
- Use the host link gateway function to program or monitor any CJ1/CS1 Series PLC connected to a Controller Link or Ethernet Network. A computer running CX-programmer will be connected (via RS-232C) to a PLC somewhere in the network.

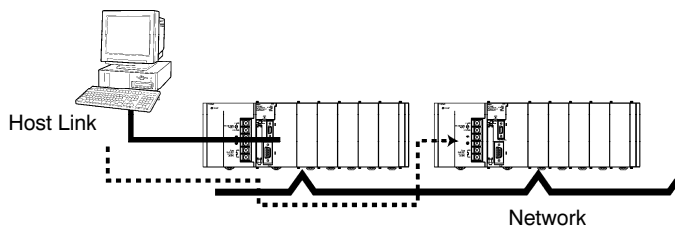

Programming and editing a PLC on a remote network

- Use the gateway function to edit any PLC connected to a network up to two networks away (3 networks including the local network). For example, a PLC on the Controller Link Network shown below can be accessed from CX-Programmer running on a computer connected to a PLC on the Ethernet Network.

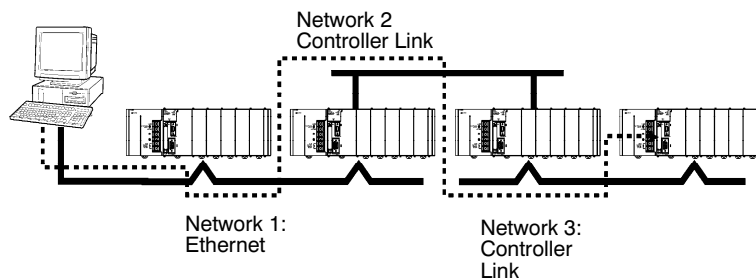

■ Common Specifications (All CJ1 CPUs)

Item	Specifications
Control method	Stored program
I/O control method	Cyclic scan and immediate processing are both possible
Programming	Ladder diagram
Instruction length	1 to 7 steps per instruction
Ladder instructions	Approx. 400 (3-digit function codes) CJ1M adds pulse I/O instructions
Execution time	Basic instructions (except CJ1M): 0.02 μ s min. Special instructions (except CJ1M): 0.04 μ s min. CJ1M Basic instructions: 0.1 μ s min. CJ1M Special instructions: 0.3 μ s min.
Overhead time	CJ1G/H-CPU□□H: Normal mode: 0.3 ms; parallel processing mode: 0.3 ms CJ1G-CPU□□: 0.5 ms CJ1M-CPU□□: 0.5 ms
Module connection method	No backplane (Modules are joined together with interlocking connectors.)
Mounting method	DIN Track mounting (screw mounting is not possible.)
Maximum number of connectable Modules	Per CPU or Expansion Rack: 10 Modules max. (i.e., Basic I/O Modules, Special I/O Modules, or CPU Bus Modules) Total per PLC: 10 Modules on CPU Rack and 10 Modules each on 3 Expansion Racks = 40 Modules max. (See Notes 1 and 2.)
Maximum number of Expansion Racks	3 max. (One CJ1 Series I/O Control Module is required on the CPU Rack, and one CJ1 Series I/O Interface Module is required on each Expansion Rack.) (See Notes 1 and 2.)
Number of tasks	288 (cyclic tasks: 32, interrupt tasks: 256) With the CJ1G/H-CPU□□H and CJ1M-CPU□□, interrupt tasks can be defined as cyclic tasks to create cyclic interrupt tasks. Note: 1. Cyclic tasks are executed each cycle and are controlled with TKON(820) and TKOF(821) instructions. 2. The following 4 types of interrupt tasks are supported: Power OFF interrupt task: 1 max. Scheduled interrupt tasks: 2 max. I/O interrupt tasks: 32 max. (CJ1G/H-CPU□□H and CJ1M-CPU□□) External interrupt tasks: 256 max. (CJ1G/H-CPU□□H and CJ1M-CPU□□)
Interrupt types	Scheduled Interrupts: Interrupts generated at a time scheduled by CPU's built-in timer I/O interrupt tasks: Interrupts from Interrupt Input Modules (CJ1G/H-CPU□□H and CJ1M-CPU□□) Power OFF Interrupts: Interrupts executed when CPU's power is turned OFF External interrupt tasks: Interrupts from Special I/O Modules and CPU Bus Modules (CJ1G/H-CPU□□H and CJ1M-CPU□□)
Calling subroutines from multiple tasks	CJ1G/H-CPU□□H and CJ1M-CPU□□: supported using global subroutines CJ1G-CPU□□: not supported

(This table continues on the next page.)

- Note: 1. The CJ1G-CPU42H and CJ1G-CPU43H support a maximum of 2 Expansion Racks with a total maximum of 30 Modules. The CJ1M-CPU13 and CJ1M-CPU23 support a maximum of 1 Expansion Rack with a total maximum of 20 Modules. The CJ1M-CPU11, CJ1M-CPU12, CJ1M-CPU21 and CJ1M-CPU22 do not support Expansion Racks.
2. Check limitations of the power supply to ensure that it can handle the current requirements of your configured system.

Additional Information: For comprehensive specifications, refer to manual No. W393.

CJ1 CPU Specifications

Common Specifications — All CJ1 CPUs (continued)

Item		Specifications	
CIO (Core I/O) Area	I/O Area	<p>CJ1G/H: 2,560 points (160 words): CIO 000000 to CIO 015915 (words CIO 0000 to CIO 0159)</p> <p>CJ1M: 320/640 points (40 words): CIO 000000 to CIO 003915 (words CIO 0000 to CIO 0039)</p> <p>Setting of first rack words can be changed from default (CIO 0000) so that CIO 0000 to CIO 0999 can be used</p> <p>I/O bits are allocated to Basic I/O Modules</p>	These bits can be used as work bits when not used for the applications described on the left.
	Link Area	<p>3,200 (200 words): CIO 100000 to CIO 119915 (words CIO 1000 to CIO 1199)</p> <p>Link bits are used for data links and are allocated to Modules in Controller Link Systems</p>	
	CPU Bus Module Area	<p>6,400 (400 words): CIO 150000 to CIO 189915 (words CIO 1500 to CIO 1899)</p> <p>CPU Bus Module bits store the operating status of CPU Bus Modules (25 words per Module, 16 Modules max.)</p>	
	Special I/O Module Area	<p>15,360 (960 words): CIO 200000 to CIO 295915 (words CIO 2000 to CIO 2959)</p> <p>Special I/O Module bits are allocated to Special I/O Modules (10 words per Module, 40 Modules max.)</p>	
	DeviceNet Area	<p>9,600 (600 words): CIO 320000 to CIO 379915 (words CIO3200 to CIO 3799)</p> <p>DeviceNet bits are allocated to Slaves for DeviceNet Module remote I/O communications when the master function is used with fixed allocations:</p> <p>Fixed allocation setting 1 Outputs: CIO 3200 to CIO 3263 Inputs: CIO 3300 to CIO 3363</p> <p>Fixed allocation setting 2 Outputs: CIO 3400 to CIO 3463 Inputs: CIO 3500 to CIO 3563</p> <p>Fixed allocation setting 3 Outputs: CIO 3600 to CIO 3663 Inputs: CIO 3700 to CIO 3763</p> <p>The following words are allocated to the master function even when the DeviceNet Module is used as a slave:</p> <p>Fixed allocation setting 1 Outputs: CIO 3370 (master to slave) Inputs: CIO 3270 (slave to master)</p> <p>Fixed allocation setting 2 Outputs: CIO 3570 (master to slave) Inputs: CIO 3470 (slave to master)</p> <p>Fixed allocation setting 3 Outputs: CIO 3770 (master to slave) Inputs: CIO 3670 (slave to master)</p>	
	Internal I/O Area (work bits)	<p>4,800 (300 words): CIO 120000 to CIO 149915 (words CIO 1200 to CIO 1499)</p> <p>37,504 (2,344 words): CIO 380000 to CIO 614315 (words CIO 3800 to CIO 6143)</p> <p>These bits in CIO Area are used as work bits in programming to control program execution; they cannot be used for external I/O.</p>	
Work Area	<p>8,192 bits (512 words): W00000 to W51115 (words W000 to W511)</p> <p>Control programs only. I/O from external I/O terminals is not possible.</p> <p>Note: When using work bits in programming, use bits in Work Area first before using bits from other areas.</p>	These bits can be used as work bits when not used for the applications described on the left.	
Holding Area	<p>8,192 bits (512 words): H00000 to H51115 (words H000 to H511)</p> <p>Holding bits are used to control execution of program, and maintain their ON/OFF status when PLC is turned OFF or operating mode is changed</p>		
Auxiliary Area	<p>Read only: 7,168 bits (448 words): A00000 to A44715 (words A000 to A447)</p> <p>Read/write: 8,192 bits (512 words): A44800 to A95915 (words A448 to A959)</p> <p>Auxiliary bits are allocated specific functions.</p>		
Temporary Area	<p>16 bits (TR00 to TR15) Temporary bits are used to store ON/OFF execution conditions at program branches.</p>		
Timer Area	<p>4,096: T0000 to T4095 (used for timers only)</p>		
Counter Area	<p>4,096: C0000 to C4095 (used for counters only)</p>		

(This table continues on the next page.)

Additional Information: For comprehensive specifications, refer to manual No. W393.

Common Specifications — All CJ1 CPUs (continued)

Item	Specifications
DM Area	<p>32K words: D00000 to D32767</p> <p>Used as a general-purpose data area for reading and writing data in word units (16 bits). Words in DM Area maintain their status when PLC is turned OFF or operating mode is changed.</p> <p>Internal Special I/O Module DM Area: D20000 to D29599 (100 words × 40 Modules). Used to set parameters for Special I/O Modules.</p> <p>CPU Bus Module DM Area: D30000 to D31599 (100 words × 16 Modules). Used to set parameters for CPU Bus Modules.</p>
EM Area	<p>32K words per bank, 7 banks max.: E0_00000 to E6_32767 max. (Not available on some CPUs.)</p> <p>Used as a general-purpose data area for reading and writing data in word units (16 bits). Words in EM Area maintain their status when PLC is turned OFF or operating mode is changed.</p> <p>The EM Area is divided into banks, and addresses can be set by either of following methods.</p> <p>Changing current bank using EMBC(281) instruction and setting addresses for current bank</p> <p>Setting bank numbers and addresses directly.</p> <p>EM data can be stored in files by specifying number of first bank. (EM file memory).</p> <p>The only available EM on CJ1M is through the use of a memory card.</p>
Index Registers	<p>IR0 to IR15. Store PLC memory addresses for indirect addressing. Index registers can be used independently in each task. One register is 32 bits (2 words).</p> <p>CJ1G-CPU□□: Index registers are independent for each task.</p> <p>CJ1G/H-CPU□□H and all CJ1M-CPU□□: Index registers can be specified as shared or independent for each task.</p>
Task Flag Area	<p>32 (TK0000 to TK0031). Task Flags are read-only flags that are ON when corresponding cyclic task is executable and OFF when corresponding task is not executable or in standby status.</p>
Trace Memory	<p>4,000 words (trace data: 31 bits, 6 words)</p>
File Memory	<p>Memory Cards: OMRON Memory Cards 15-MB, 30-MB, or 64-MB capacities can be used. (MS-DOS format)</p> <p>EM file memory: Part of EM Area can be converted to file memory (MS-DOS format). This cannot be done on CJ1M-CPU□□.</p>

Additional Information: For comprehensive specifications, refer to manual No. W393.

CJ1 CPUs

■ Function Specifications for All CJ1 CPUs

Item	Specifications	
Constant cycle time	1 to 32,000 ms (Unit: 1 ms) Note: With the CJ1G/H-CPU□□H, using the Parallel Processing Mode will create a constant cycle time for program execution.	
Cycle time monitoring	Possible (The CPU stops operating if cycle is too long): 10 to 40,000 ms (Unit: 10 ms) Note: When the Parallel Processing Mode is used for the CJ1G/H-CPU□□H, and CJ1M-CPU□□ the program execution cycle is monitored. Also, a fatal error will occur in the CPU if the peripheral servicing time exceeds 2 s.	
I/O refreshing	Cyclic refreshing, immediate refreshing, refreshing by IORF(097). With the CJ1G/H-CPU□□H and CJ1M-CPU□□, the CPU BUS UNIT I/O REFRESH (DLNK) instruction can be used to refresh CPU BUS Modules (including allocated CIO and DM Area words) when required in the program.	
Special refreshing for CPU Bus Modules	Data links for Control Link Modules, remote I/O communications for DeviceNet Modules, and other special data for CPU Bus Modules is refreshed at the following times. CJ1G-CPU□□: During I/O refresh period. CJ1G/H-CPU□□H and CJ1M-CPU□□: During I/O refresh period or when CPU BUS UNIT I/O REFRESH (DLNK) instruction is executed.	
I/O memory holding when changing operating modes	Depends on ON/OFF status of IOM Hold Bit in Auxiliary Area.	
Load OFF	All outputs on Output Modules can be turned OFF when the CPU is in RUN, MONITOR, or PROGRAM mode.	
Input time constant setting	Time constants can be set for inputs from CJ1 Series Basic I/O Modules. The time constant can be increased to reduce influence of noise and chattering, or it can be decreased to detect shorter pulses on inputs.	
Operating mode setting at power-up	Possible (By default, the CPU will start in RUN mode if a Programming Console is not connected.)	
Built-in flash memory	User program and parameter areas (e.g., PC Setup) are automatically backed up and restored.	
Memory Card functions	Automatically reading programs (autoboot) from the Memory Card when the power is turned ON.	Possible
	Program replacement during PLC operation.	Possible
	Memory Card storage data	User program: Program file format. PLC Setup and other parameters: Data file format. I/O memory: Data file format (binary), text format, CSV format. CPU Bus Module data: Special format
	Memory Card read/write method	User program instructions, Programming Devices (including CX-Programmer and Programming Console), Host Link computers, AR Area control bits, easy backup operation.
Filing	Memory Card data and EM (Extended Data Memory) Area can be handled as files. There is no EM on CJ1M models.	
Debugging	Force-set/reset, differential monitoring, data tracing (scheduled, each cycle, or when instruction is executed).	
Online editing	One or more program blocks in user programs can be overwritten when CPU is in PROGRAM or MONITOR mode. This function is not available for block programming areas. With CX-Programmer, more than one program block can be edited at the same time.	
Program protection	Overwrite protection: Set using DIP switch. Copy protection: Password set using CX-Programmer.	
Error check	User-defined errors (i.e., user can define fatal errors and non-fatal errors). The FPD(269) instruction can be used to check execution time and logic of each programming block. Note: With the CJ1G/H-CPU□□H and CJ1M-CPU□□, error status can be simulated with the FAL and FALS instructions.	
Error log	Up to 20 errors are stored in error log. Information includes error code, error details, and time error occurred. Note: With the CJ1G/H-CPU□□H and CJ1M-CPU□□, the system can be set so that user-defined FAL errors are not stored in the error log.	

(This table continues on the next page.)

Additional Information: For comprehensive specifications, refer to manual No. W393.

Function Specifications for CJ1 CPUs (continued)

Item	Specifications
Serial communications	<p>Built-in peripheral port: Programming Device (e.g., CX-Programmer or Programming Console), Host Links, NT Links</p> <p>Built-in RS-232C port: Programming Device (e.g., CX-Programmer), Host Links, no-protocol communications, NT Links</p> <p>Serial Communications Module (sold separately): Protocol macros, Host Links, NT Links</p>
Clock	<p>Provided on all models. Accuracy: ± 1.5 min/mo. at 25°C (accuracy varies with the temperature)</p> <p>Note: Used to store time when power is turned ON and when errors occur.</p>
Power OFF detection time	10 to 25 ms (not fixed)
Power OFF detection delay time	0 to 10 ms (user-defined, default: 0 ms)
Memory protection	<p>Held Areas: Holding bits, user program, Data Memory, Extended Data Memory, and status of counter Completion Flags and present values.</p> <p>Note: If IOM Hold Bit in Auxiliary Area is turned ON, and PLC Setup is set to maintain IOM Hold Bit status when power to PLC is turned ON, contents of CIO Area, Work Area, part of Auxiliary Area, timer Completion Flag and PVs, Index Registers, and Data Registers will be saved for up to 20 days.</p>
Sending commands to a Host Link computer	FINS commands can be sent to a computer connected via Host Link System by executing Network Communications Instructions from PLC.
Remote programming and monitoring	Host Link communications can be used for remote programming and remote monitoring through a Controller Link System or Ethernet network.
Three-level communications	Host Link communications can be used for remote programming and remote monitoring from devices on networks up to two levels away (Controller Link Network, Ethernet Network, or other network).
Storing comments in the CPU	I/O comments can be stored in CPU in Memory Cards or EM file memory. There is no EM on the CJ1M models.
Program check	Program checks are performed for items such as no END instruction and instruction errors. CX-Programmer can also be used to check programs.
Control output signals	RUN output: The internal contacts will turn ON (close) while the CPU is operating (CJ1W-PA205R).
Battery life	<p>5 years at 25°C (The battery life depends on the ambient operating temperature; 0.75 years min.)</p> <p>Battery Set: CPM2A-BAT01 for CJ1G/H-CPU□□ and CJ1W-BAT01 for CJ1M-CPU□□</p> <p>Note: Use a replacement battery that is no more than 2 years old from the date of manufacture.</p>
Self-diagnostics	CPU errors (watchdog timer), I/O bus errors, memory errors, and battery errors
Storage of Power-Off times	Storage of number of times power has been interrupted. (Stored in A514.)

Additional Information: For comprehensive specifications, refer to manual No. W393.

CJ1M CPU (Only) Specifications

■ Pulse Input Specifications

Interrupt Inputs and Quick-Response Inputs

Item		Specifications
Number of interrupt and quick-response input points		4 total
Interrupt inputs	Interrupt input mode	At the rising or falling edge of the input signal, the CPU's cyclic program is interrupted and the corresponding I/O interrupt task (task number 140 to 143) is executed. The response time (i.e., the time from the input condition being satisfied until execution of the interrupt task) is 20 μ s max.
	Counter mode	The number of rising or falling edges of the input signal are counted incrementally or decrementally, and when the count has been reached, the corresponding interrupt task (task number 140 to 143) is executed. The input response frequency is 1 kHz.
Quick-response input		Signals less than the cycle time (30 μ s min.) can be treated as ON signals for one cycle.

■ High-Speed Counter Input

Item		Specification			
Number of high-speed counter inputs		2 (high-speed counters 0 and 1)			
Counter modes (set in the PC Setup)		Phase differential inputs (phase-A, -B, and -Z inputs)	Up and down pulse inputs (incremental pulse, decremental pulse, and reset inputs)	Pulse + direction inputs (pulse, direction, and reset inputs)	Incremental pulse input (incremental pulse and reset inputs)
Response frequency	Line driver input	50 kHz	100 kHz	100 kHz	100 kHz
	24-VDC input	30 kHz	60 kHz	60 kHz	60 kHz
Counter type		Linear counter or circular counter (set in the PC Setup)			
Counting range		Linear counter: 8000 0000 to 7FFF FFFF Hex Circular counter: 0000 0000 to circular counter set value (The circular counter set value is set in the PC Setup in the range 0000 0001 to FFFF FFFF Hex.)			
High-speed counter present value storage words		High-speed counter 0: A270 (upper digits) and A271 (lower digits) High-speed counter 1: A272 (upper digits) and A273 (lower digits) Target value comparison inputs and range comparison inputs are possible for these values. Note: The present values are updated each cycle as part of common processing. Use the PRV instruction to read the latest value.			
Control method		Target value comparison: Up to 48 target values and interrupt task numbers can be registered.			
		Range comparison: Up to 8 upper limits, lower limits, and interrupt task numbers can be registered.			
Counter reset method		Z-phase signal + software reset: Counter reset when the Z-phase input is turned ON with the reset bit (see below) ON. Software reset: Counter reset when the reset bit (see below) turns ON. Reset bit: A531, bit 00 (high-speed counter 0); A531, bit 01 (high-speed counter 1)			

CJ1M CPU (Only) Specifications

■ Pulse Output Specifications

Positioning and Speed Control Functions

Item	Specification
Output frequency	1 Hz to 100 kHz (1 to 100 Hz: 1 Hz units; 100 Hz to 4 kHz: 10 Hz units; 4 to 100 kHz: 100 Hz units)
Frequency acceleration/deceleration rate	1 Hz to 2 kHz (every 4 ms), set in 1 Hz units Acceleration and deceleration for the PLS2 instruction can be set individually.
Changing set values during instruction execution	The target frequency, acceleration/deceleration rate, and target position can be changed. The target frequency and acceleration/deceleration rate can only be changed for positioning at a constant speed.
Pulse output method	CW/CCW or pulse + direction
Number of output pulses	Relative coordinate specifications: 0000 0000 to 7FFF FFFF Hex (2,147,483,647 in either incremental or decremental direction) Absolute coordinate specifications: 8000 0000 to 7FFF FFFF Hex (-2,147,483,648 to 2,147,483,647)
Instruction for origin search/reset	ORG (ORIGIN SEARCH): Used to perform origin searches or origin resets according to set parameters.
Instructions for positioning and speed control	PLS2 (PULSE OUTPUT): Used to output pulses for trapezoidal positioning with individually set acceleration and deceleration rates. PULS (SET PULSES): Used to set the number of output pulses. SPED (SPEED OUTPUT): Used to output pulses without acceleration or deceleration. (The number of pulses must be set beforehand using the PULS instruction to perform positioning.) ACC (ACCELERATION CONTROL): Used to control the acceleration/deceleration rate. INI (MODE CONTROL): Used to stop pulse output.
Pulse output present value storage area	AR Area Words Pulse output 0: A276 (lower 4 digits) and A277 (upper 4 digits) Pulse output 1: A278 (lower 4 digits) and A279 (upper 4 digits) The present values are updated each cycle as part of overhead processing. The pulse output present value can be read to specified words using PRV (HIGH-SPEED COUNTER PV READ).

Pulse with Variable Duty Factor (PWM) Output Function

Item	Specification
Duty ratio	0% to 100%, set in 1% units
Frequency	0.1 to 999.9 Hz, set in 0.1-Hz units
Instruction for PWM	PWM (PULSE WITH VARIABLE DUTY FACTOR): Used to output pulses with the specified duty factor.

CJ1M CPU (Only) Specifications

■ Hardware Specifications

Input Specifications

Item		Specification			
Number of input points		10 points			
Input type	Selection	24-VDC input or line driver input (switched with wiring)			
	Source	24-VDC input		Line driver input	
	Input points	IN0 to IN5	IN6 to IN9	IN0 to IN5	IN6 to IN9
Input voltage		20.4 to 26.4 VDC		Conforms to RS-422 line driver (equivalent to AM26LS31). The power supply voltage on the connected side must be 5 V \pm 5%.	
Input impedance		3.6 k Ω	4.0 k Ω		
Input current (typ.)		6.2 mA	4.1 mA	13 mA	10 mA
ON voltage (min.)		17.4 VDC min./3 mA min.		—	
ON voltage (max.)		5.0 VDC/1 mA min.		—	
Response speed (for general-purpose input)	OFF response time	8 ms max. (Select 0, 0.05, 1, 2, 4, 8, 16, or 32 ms in PC Setup.)			
	OFF response time	8 ms max. (Select 0, 0.05, 1, 2, 4, 8, 16, or 32 ms in PC Setup.)			

Circuit Configuration

Input	IN to IN5	IN6 to IN9
Circuit configuration		

■ General-Purpose Output Specifications: Transistor Outputs (Sinking)

Outputs	OUT0 to OUT3	OUT4 to OUT5
Rated voltage	5 to 24 VDC	
Allowable voltage range	4.75 to 26.4 V	
Maximum switching current	0.3 A per point, 1.8 A per Unit	
Outputs per common	6 points	
Maximum inrush current	3.0 A per point for 10 ms max.	
Leakage current	0.1 mA max.	
Residual voltage	0.6 V max.	
ON response time	0.1 ms max.	
OFF response time	0.1 ms max.	
Fuse	None	
External power supply	10.2 to 26.4 VDC, 50 mA min.	
Circuit configuration		

■ Pulse Output Specifications (OUT0 to OUT3)

Item	Specification
Maximum switching capacity	30 mA, 4.75 to 26.4 VDC
Minimum switching capacity	30 mA, 4.75 to 26.4 VDC
Maximum output frequency	100 kHz
Output waveform	

CJ1 PLC General Specifications

■ General Specifications — All CPUs

Item	Specifications
Noise immunity	Conforms to IEC61000-4-4, 2 kV (power lines)
Vibration resistance	10 to 57 Hz, 0.075-mm amplitude, 57 to 150 Hz, acceleration: 9.8 m/s ² in X, Y, and Z directions for 80 minutes. (Time coefficient: 8 minutes × coefficient factor 10 = total time 80 min.)
Shock resistance	147 m/s ² , 3 times each in X, Y, and Z directions (Relay Output Module: 100 m/s ²)
Ambient operating temperature	0 to 55°C
Ambient operating humidity	10% to 90% (with no condensation)
Atmosphere	Must be free from corrosive gases.
Ambient storage temperature	-20 to 75°C (excluding battery)
Grounding	Less than 100 Ω
Enclosure	Mounted in a panel
Weight	5 kg max. for each unit
CJ1 Series CPU Rack dimensions	Refer to "Dimensions" in the <i>Reference</i> Section of this catalog
Safety standards	Conforms to cULus and EC directives

■ Battery Set

Item	Model	Specifications
Battery Set	CPM2A-BAT01	Can also be used with CPM2A and CQM1H PLCs. (This battery cannot be used for CS1 Series PLCs.)
	CJ1W-BAT01	Can be used with CJ1M only. (This battery cannot be used for CJ1G/H or CS1 PLCs.)



Компания «ЭлектроПласт» предлагает заключение долгосрочных отношений при поставках импортных электронных компонентов на взаимовыгодных условиях!

Наши преимущества:

- Оперативные поставки широкого спектра электронных компонентов отечественного и импортного производства напрямую от производителей и с крупнейших мировых складов;
- Поставка более 17-ти миллионов наименований электронных компонентов;
- Поставка сложных, дефицитных, либо снятых с производства позиций;
- Оперативные сроки поставки под заказ (от 5 рабочих дней);
- Экспресс доставка в любую точку России;
- Техническая поддержка проекта, помощь в подборе аналогов, поставка прототипов;
- Система менеджмента качества сертифицирована по Международному стандарту ISO 9001;
- Лицензия ФСБ на осуществление работ с использованием сведений, составляющих государственную тайну;
- Поставка специализированных компонентов (Xilinx, Altera, Analog Devices, Intersil, Interpoint, Microsemi, Aeroflex, Peregrine, Syfer, Eurofarad, Texas Instrument, Miteq, Cobham, E2V, MA-COM, Hittite, Mini-Circuits, General Dynamics и др.);

Помимо этого, одним из направлений компании «ЭлектроПласт» является направление «Источники питания». Мы предлагаем Вам помощь Конструкторского отдела:

- Подбор оптимального решения, техническое обоснование при выборе компонента;
- Подбор аналогов;
- Консультации по применению компонента;
- Поставка образцов и прототипов;
- Техническая поддержка проекта;
- Защита от снятия компонента с производства.



Как с нами связаться

Телефон: 8 (812) 309 58 32 (многоканальный)

Факс: 8 (812) 320-02-42

Электронная почта: org@eplast1.ru

Адрес: 198099, г. Санкт-Петербург, ул. Калинина, дом 2, корпус 4, литера А.