



Basic Board Mount
Pressure Sensors
NBP Series, Uncompensated/Unamplified
60 mbar to 10 bar | 1 psi to 150 psi
Millivolt Analog Output



Basic Board Mount Pressure Sensors

Honeywell's Basic Board Mount Pressure Sensors: NBP Series—Uncompensated/Unamplified are low pressure sensors designed for customers who require a simple, cost-effective, basic performance, mV output, unamplified, uncompensated, high quality, infinite resolution solution for medical and industrial applications.

These unamplified and uncompensated sensors offer infinite resolution of the pressure signal. They will operate as specified from -40 °C to 125 °C [-40 °F to 257 °F].

The NBP Series is often ideal for those customers who want to do their own compensation, calibration, and amplification in order to make use of the maximum resolution of the bare sensor output, leveraging any algorithm needed for the application.

Additionally, the NBP Series offers several package styles and mounting options, making it easier for device manufacturers to integrate the product into their applications.

The NBP Series measures absolute or gage pressures. The absolute versions have an internal vacuum reference and an output value proportional to absolute pressure. Gage versions are referenced to atmospheric pressure and provide an output proportional to pressure variations from atmosphere.

The NBP Series sensors are intended for use with non-corrosive, non-ionic gases, such as air and other dry gases and for non-corrosive, non-ionic liquids. All products are designed and manufactured according to ISO 9001.

What makes our sensors better?

- **Quality:** Six Sigma standards provide the highest level of quality, accuracy, performance and consistency
- **Reliability:** Dependable supply chain
- **Delivery:** Fast response to orders and sample requests



COST EFFECTIVE • HIGH QUALITY • HIGH RELIABILITY

Features and Benefits

COST-EFFECTIVE

These devices provide a cost-effective pressure sensing solution with a variety of options that help customers to meet their specific application needs

Cost-effective sensing solution.

SMALL SIZE

Package size (as small as 7 mm x 7 mm [0.276 in x 0.276 in]) is very small when compared to most board mount pressure sensors, occupying less space on the PCB and typically allowing for easy placement on crowded PCBs or in small devices

Frees up PCB space, reduces costs.

DURABLE

Many features allow for use in tough environments, including:

Wide operating temperature range of -40 °C to 125 °C [-40 °F to 257 °F] allows for use in many applications

Media compatibility options:

- **Non-gel coating:** The input port is limited to non-corrosive, non-ionic media such as dry air and gases and should not be exposed to condensation; the gases are limited to media that are compatible with high temperature polyamide, silicone, alumina ceramic, silicon, gold, and glass
- **Gel coating:** Uses the same materials in the wetted media path but is protected from condensation by a silicone-based gel coating; allows use in applications where condensation can occur

ISO 9001 compliance

Excels in tough environments with dry and wetted media.

FLEXIBLE

Numerous package styles, pressure ranges, housings, gel coating, and porting options simplify integration into the device manufacturer's application

Choose options to best fit the application.

ROBUST

Reflow mounting J-STD-020D, MSL 1 and rapid stabilization after reflow soldering allow calibration immediately after mounting

Features and Benefits

HONEYWELL BRAND

Manufacturing excellence: Honeywell has more than 100 years of manufacturing and engineering excellence

Fast Request for Quotes (RFQs): Responding quickly to your RFQs and product sample needs is a hallmark of Honeywell. Our experienced engineers understand the importance of timely quotes. And because Honeywell is a manufacturer, you can depend on a quick response to your prototype needs

High quality, high resolution solution.

Fast response for samples: Dedicated teams and manufacturing processes help ensure that product samples are shipped quickly and delivered in time to support your development cycle

Reliable supply chain: Honeywell's effective inventory management and dependable supply chain is there throughout your product life cycle

Designed to Six Sigma standards: Six Sigma standards provide the highest level of product quality, performance, and consistency. Six Sigma provides confidence that the sensor will perform to specification. Many competitive products are produced to lower Sigma tolerances, which may result in some products not performing to the specification to which they were designed

Supporting documentation: Honeywell's website provides numerous technical materials to assist you in your application needs

Potential Applications



MEDICAL

- HOSPITAL BEDS
- OXYGEN CONCENTRATORS
- WOUND THERAPY
- BLOOD PRESSURE MONITORING



INDUSTRIAL

- HVAC TRANSMITTERS
- AIR MOVEMENT CONTROL
- ENVIRONMENTAL CONTROL
- LEAK DETECTION
- INDUSTRIAL CONTROLS
- PNEUMATIC CONTROLS
- OTHER COMMERCIAL APPLICATIONS



NBP Series, Uncompensated/Unamplified

Figure 1. Nomenclature and Order Guide

For example, **NBPDANN150PGUNV** defines an NBP Series Basic Board Mount Pressure Sensor, DIP package, AN pressure port, no gel coating in media path, 150 psi gage pressure range, unamplified, uncompensated, constant supply voltage.



Basic Board Mount Pressure Sensors

Table 1. Absolute Maximum Ratings¹

| Characteristic | Min. | Max. | Unit |
|---|-----------|---|-----------------|
| Supply voltage (V _{supply}) | -12.0 | 12.0 | V _{dc} |
| Storage temperature | -40 [-40] | 125 [257] | °C [°F] |
| Soldering time and temperature: lead solder temperature (DIP) peak reflow temperature (Leadless SMT, SMT) | | 4 s max. at 250 °C [482 °F] 15 s max. at 250 °C [482 °F] | |

¹Absolute maximum ratings are the extreme limits the device will withstand without damage.

Table 2. Environmental Specifications

| Characteristic | Parameter |
|--|--|
| Humidity: all external surfaces internal surfaces of gel coating option internal surfaces of non-gel coating option | 0 %RH to 95 %RH, non-condensing 0 %RH to 100 %RH, condensing 0 %RH to 95 %RH, non-condensing |
| Vibration | MIL-STD-202G, Method 204D, Condition B (15 g, 10 Hz to 2 kHz) |
| Shock | MIL-STD-202G, Method 213B, Condition C (100 g, 6 ms duration) |
| Life ¹ | 1 million pressure cycles min. |
| ESD | MIL-STD-883 Method 3015.7 |
| Solder reflow | J-STD-020D, MSL 1, unlimited storage life |

¹Life may vary depending on specific application in which sensor is utilized.

Table 3. Wetted Materials¹

| Characteristic | Non-Gel Coating Option | Gel Coating Option |
|-----------------------|-------------------------------|---|
| Covers | high temperature polyamide | high temperature polyamide |
| Substrate | alumina ceramic | not exposed - protected by silicone gel |
| Adhesives | epoxy, RTV | epoxy |
| Electronic components | ceramic, silicon, gold, glass | not exposed - protected by silicone gel |

¹Contact Honeywell Customer Service for detailed material information.

CAUTION MISUSE OF GEL COATING OPTION

- Non-gel coating option: The input port is limited to non-corrosive, non-ionic media such as dry air and gases and should not be exposed to condensation. The gases are limited to media that are compatible with the following wetted materials of construction: high temperature polyamide, silicone, alumina ceramic, silicon, gold, and glass.
- Gel coating option: The gel coated sensors use the same materials in the wetted media path but are protected from condensation by a silicone-based gel coating. The gel coating option allows use in applications where condensation can occur.

Failure to comply with these instructions may result in product damage.

NBP Series, Uncompensated/Unamplified

Table 4. Operating Specifications

| Characteristic | Min. | Typ. | Max. | Unit |
|--|-----------|------|-----------|------------------------|
| Supply voltage (V _{supply}) ^{1,2} | 1.8 | 5.0 | 12.0 | Vdc |
| Supply current (at 5.0 Vdc supply) | - | 1.5 | 2.5 | mA |
| Specified temperature range ³ | -40 [-40] | - | 125 [257] | °C [°F] |
| Accuracy ⁴ | - | - | ±0.25 | %FSS BFSL ⁵ |
| Input resistance | 2.4 | 3.0 | 5.5 | kOhm |
| Thermal effect on resistance (TER) ⁶ | 1200 | - | 3200 | ppm/°C |

¹ Ratiometricity of the sensor (the ability of the device output to scale to the supply voltage) is achieved within the specified operating voltage.

² Incorrect application of supply voltage or ground to the wrong pin may cause electrical failure.

³ The specified temperature range is the temperature range over which the sensor will produce an output proportional to pressure within the specified performance limits.

⁴ Accuracy: The maximum deviation in output from a Best Fit Straight Line (BFSL) fitted to the output measured over the pressure range at 25 °C [77 °F]. Includes all errors due to pressure non-linearity, pressure hysteresis, and non-repeatability.

⁵ Full Scale Span (FSS) is the algebraic difference between the output signal measured at the maximum and minimum limits of the pressure range. (See Figure 1 for ranges.)

⁶ TER (Thermal Effect on Resistance): The deviation in input resistance due to change in temperature over the specified temperature range, relative to input resistance measured at 25 °C [77 °F].

Basic Board Mount Pressure Sensors

Table 5. Pressure Range Specifications for 60 mbar to 10 bar

| Pressure Range (see Figure 1) | Pressure Range | | Unit | Over Pressure | Burst Pressure | Offset ¹ (mV/V) | | Sensitivity (mV/V/Full Scale Span) | | | TCO ² (%FSS/25 °C) | | | TCS ³ (%FSS/25 °C) | | |
|----------------------------------|----------------|-------|------|---------------|----------------|-------------------------------|------|---------------------------------------|------|------|----------------------------------|------|------|----------------------------------|------|------|
| | Pmin. | Pmax. | | | | Min. | Max. | Min. | Nom. | Max. | Min. | Nom. | Max. | Min. | Nom. | Max. |
| Absolute | | | | | | | | | | | | | | | | |
| 001BA | 0 | 1 | bar | 2 | 4 | -7.0 | 7.0 | 10.0 | 15.0 | 20.0 | -1.5 | -0.5 | 1.5 | -6.0 | -5.0 | -3.5 |
| 1.6BA | 0 | 1.6 | bar | 4 | 8 | -7.0 | 7.0 | 12.0 | 16.0 | 20.0 | -1.5 | -0.5 | 1.5 | -6.0 | -5.0 | -3.5 |
| 2.5BA | 0 | 2.5 | bar | 4 | 8 | -7.0 | 7.0 | 18.8 | 25.0 | 31.3 | -1.0 | -0.3 | 1.0 | -6.0 | -5.0 | -3.5 |
| 004BA | 0 | 4 | bar | 8 | 16 | -7.0 | 7.0 | 16.8 | 20.0 | 23.2 | -1.0 | -0.3 | 1.0 | -6.0 | -5.0 | -3.5 |
| 006BA | 0 | 6 | bar | 16 | 20 | -7.0 | 7.0 | 12.6 | 15.0 | 17.4 | -1.5 | -0.4 | 1.5 | -6.0 | -5.0 | -3.5 |
| 010BA | 0 | 10 | bar | 16 | 20 | -7.0 | 7.0 | 21.0 | 25.0 | 29.0 | -1.0 | -0.3 | 1.0 | -6.0 | -5.0 | -3.5 |
| Gage | | | | | | | | | | | | | | | | |
| 060MG | 0 | 60 | mbar | 850 | 1400 | -8.5 | 8.5 | 3.9 | 5.7 | 7.4 | -3.5 | -1.2 | 3.5 | -6.0 | -5.0 | -3.5 |
| 100MG | 0 | 100 | mbar | 850 | 1400 | -8.5 | 8.5 | 6.6 | 9.4 | 12.3 | -2.1 | -0.7 | 2.1 | -6.0 | -5.0 | -3.5 |
| 160MG | 0 | 160 | mbar | 850 | 1400 | -8.5 | 8.5 | 10.5 | 15.1 | 19.7 | -1.3 | -0.4 | 1.3 | -6.0 | -5.0 | -3.5 |
| 250MG | 0 | 250 | mbar | 1800 | 3000 | -8.5 | 8.5 | 7.3 | 10.9 | 14.5 | -2.1 | -0.7 | 2.1 | -6.0 | -5.0 | -3.5 |
| 400MG | 0 | 400 | mbar | 1800 | 3000 | -8.5 | 8.5 | 11.7 | 17.4 | 23.2 | -1.3 | -0.4 | 1.3 | -6.0 | -5.0 | -3.5 |
| 600MG | 0 | 600 | mbar | 2000 | 4000 | -7.0 | 7.0 | 6.0 | 9.0 | 12.0 | -2.5 | -1.0 | 2.5 | -6.0 | -5.0 | -3.5 |
| 001BG | 0 | 1 | bar | 2 | 4 | -7.0 | 7.0 | 10.0 | 15.0 | 20.0 | -1.5 | -0.5 | 1.5 | -6.0 | -5.0 | -3.5 |
| 1.6BG | 0 | 1.6 | bar | 4 | 8 | -7.0 | 7.0 | 12.0 | 16.0 | 20.0 | -1.5 | -0.5 | 1.5 | -6.0 | -5.0 | -3.5 |
| 2.5BG | 0 | 2.5 | bar | 4 | 8 | -7.0 | 7.0 | 18.8 | 25.0 | 31.3 | -1.0 | -0.3 | 1.0 | -6.0 | -5.0 | -3.5 |
| 004BG | 0 | 4 | bar | 8 | 16 | -7.0 | 7.0 | 16.8 | 20.0 | 23.2 | -1.0 | -0.3 | 1.0 | -6.0 | -5.0 | -3.5 |
| 006BG | 0 | 6 | bar | 16 | 20 | -7.0 | 7.0 | 12.6 | 15.0 | 17.4 | -1.5 | -0.4 | 1.5 | -6.0 | -5.0 | -3.5 |
| 010BG | 0 | 10 | bar | 16 | 20 | -7.0 | 7.0 | 21.0 | 25.0 | 29.0 | -1.0 | -0.3 | 1.0 | -6.0 | -5.0 | -3.5 |

¹ Offset: The output signal obtained when the reference pressure is applied to all available pressure ports. Also known as “null” or “zero”.

² TCO (Thermal Effect on Offset): The deviation in offset due to changes in temperature over the specified temperature range, relative to offset measured at 25 °C.

³ TCS (Thermal Effect on Span): The deviation in full scale span due to changes in temperature over the specified temperature range, relative to full scale span measured at 25 °C.

NBP Series, Uncompensated/Unamplified

Table 6. Pressure Range Specifications for 1 psi to 150 psi

| Pressure Range (see Figure 1) | Pressure Range | | Unit | Over Pressure | Burst Pressure | Offset ¹ (mV/V) | | Sensitivity (mV/V/Full Scale Span) | | | TCO ² (%FSS/25 °C) | | | TCS ³ (%FSS/25 °C) | | |
|----------------------------------|----------------|-------|------|---------------|----------------|-------------------------------|------|---------------------------------------|------|------|----------------------------------|------|------|----------------------------------|------|------|
| | Pmin. | Pmax. | | | | Min. | Max. | Min. | Nom. | Max. | Min. | Nom. | Max. | Min. | Nom. | Max. |
| Absolute | | | | | | | | | | | | | | | | |
| 015PA | 0 | 15 | psi | 30 | 60 | -7.0 | 7.0 | 10.3 | 15.0 | 20.7 | -1.5 | -0.6 | 1.5 | -6.0 | -5.0 | -3.5 |
| 030PA | 0 | 30 | psi | 60 | 120 | -7.0 | 7.0 | 15.5 | 21.0 | 26.0 | -1.0 | -0.4 | 1.0 | -6.0 | -5.0 | -3.5 |
| 060PA | 0 | 60 | psi | 120 | 240 | -7.0 | 7.0 | 17.4 | 21.0 | 24.0 | -1.0 | -0.3 | 1.0 | -6.0 | -5.0 | -3.5 |
| 100PA | 0 | 100 | psi | 240 | 300 | -7.0 | 7.0 | 14.5 | 17.2 | 20.0 | -1.0 | -0.4 | 1.0 | -6.0 | -5.0 | -3.5 |
| 150PA | 0 | 150 | psi | 240 | 300 | -7.0 | 7.0 | 21.7 | 26.0 | 30.0 | -1.0 | -0.3 | 1.0 | -6.0 | -5.0 | -3.5 |
| Gage | | | | | | | | | | | | | | | | |
| 001PG | 0 | 1 | psi | 10 | 20 | -8.5 | 8.5 | 4.5 | 6.5 | 8.5 | -3.0 | -1.0 | 3.0 | -6.0 | -5.0 | -3.5 |
| 005PG | 0 | 5 | psi | 30 | 40 | -8.5 | 8.5 | 10.0 | 15.0 | 20.0 | -1.5 | -0.5 | 1.5 | -6.0 | -5.0 | -3.5 |
| 015PG | 0 | 15 | psi | 30 | 60 | -7.0 | 7.0 | 10.3 | 15.0 | 20.7 | -1.5 | -0.6 | 1.5 | -6.0 | -5.0 | -3.5 |
| 030PG | 0 | 30 | psi | 60 | 120 | -7.0 | 7.0 | 15.5 | 21.0 | 26.0 | -1.0 | -0.4 | 1.0 | -6.0 | -5.0 | -3.5 |
| 060PG | 0 | 60 | psi | 120 | 240 | -7.0 | 7.0 | 17.4 | 21.0 | 24.0 | -1.0 | -0.3 | 1.0 | -6.0 | -5.0 | -3.5 |
| 100PG | 0 | 100 | psi | 240 | 300 | -7.0 | 7.0 | 14.5 | 17.2 | 20.0 | -1.0 | -0.4 | 1.0 | -6.0 | -5.0 | -3.5 |
| 150PG | 0 | 150 | psi | 240 | 300 | -7.0 | 7.0 | 21.7 | 26.0 | 30.0 | -1.0 | -0.3 | 1.0 | -6.0 | -5.0 | -3.5 |

¹ Offset: The output signal obtained when the reference pressure is applied to all available pressure ports. Also known as “null” or “zero”.

² TCO (Thermal Effect on Offset): The deviation in offset due to changes in temperature over the specified temperature range, relative to offset measured at 25 °C.

³ TCS (Thermal Effect on Span): The deviation in full scale span due to changes in temperature over the specified temperature range, relative to full scale span measured at 25 °C.

Table 7. Pressure Types

| Pressure Type | Description |
|---------------|---|
| Absolute | Output is proportional to the difference between applied pressure and a built-in reference to vacuum. Reference pressure is absolute zero pressure (full vacuum). |
| Gage | Output is proportional to the difference between applied pressure and atmospheric (ambient) pressure. Reference pressure is atmospheric pressure. |

Basic Board Mount Pressure Sensors

Figure 2. DIP Package Dimensional Drawings (For reference only: mm [in].)

AN: Single axial barbed port

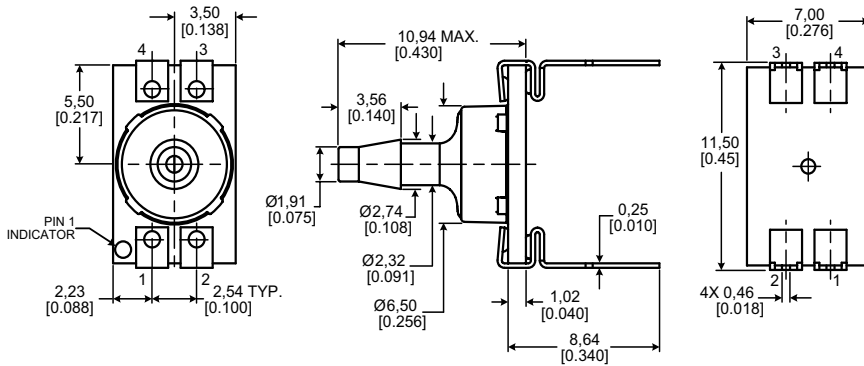

Recommended PCB Pad Layout

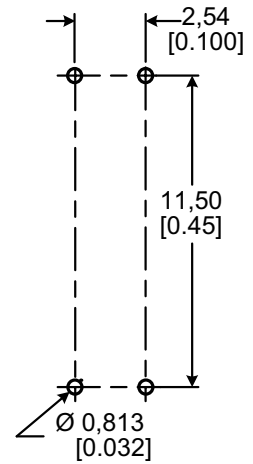
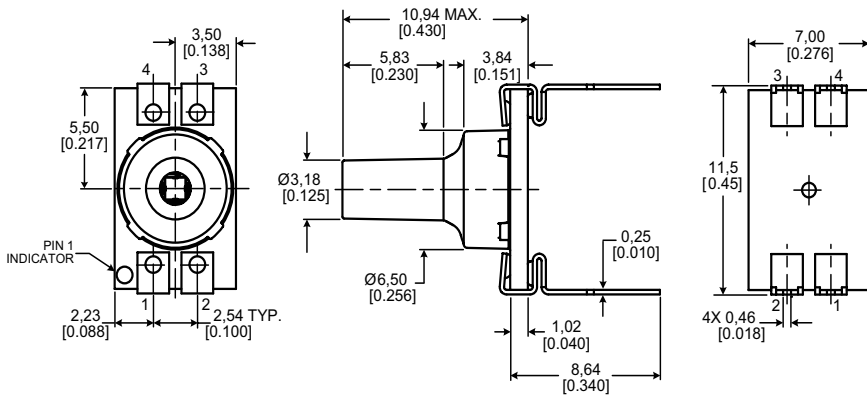

Table 8. Pinout for DIP Packages

| Pin 4 | Pin 3 |
|---------|-------|
| Vout+ | GND |
| Pin 1 | Pin 2 |
| Vsupply | Vout- |

LN: Single axial barbless port



PN: Low-profile port

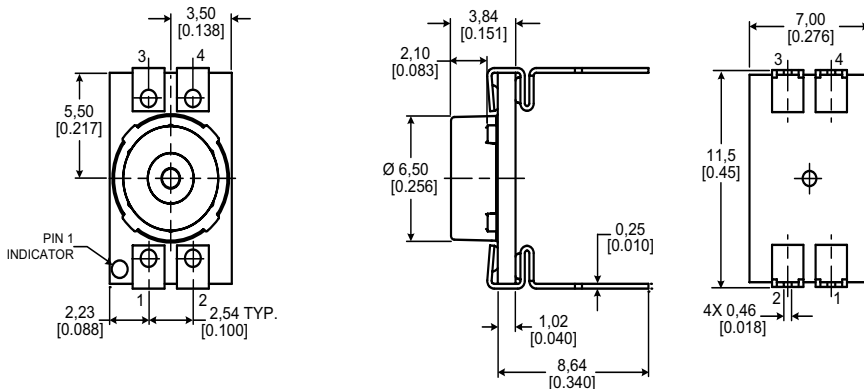

NBP Series, Uncompensated/Unamplified

Figure 3. Leadless SMT Package Dimensional Drawings (For reference only: mm [in].)

AN: Single axial barbed port

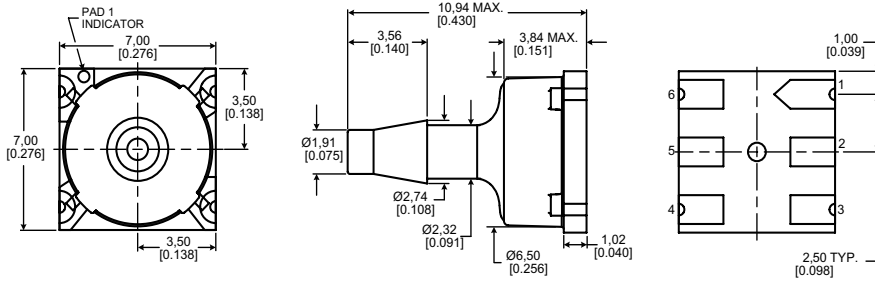

Recommended PCB Pad Layout

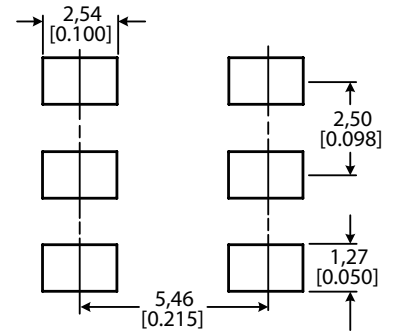

LN: Single axial barbless port

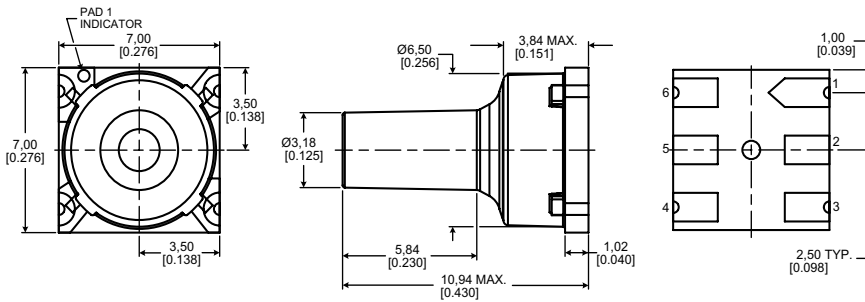
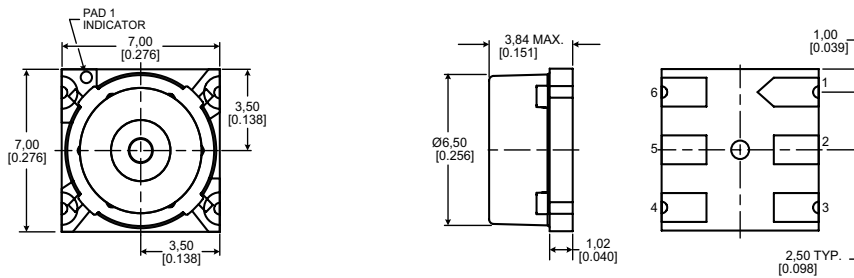

Table 9. Pinout for Leadless SMT Pressure Packages

| Pad 1 | Pad 6 |
|---------|-------|
| Vsupply | Vout+ |
| Pad 2 | Pad 5 |
| NC | NC |
| Pad 3 | Pad 4 |
| Vout- | GND |

PN: Low-profile port



Basic Board Mount Pressure Sensors

Figure 4. SMT Package Dimensional Drawings (For reference only: mm [in])

AN: Single axial barbed port



Recommended PCB Pad Layout



LN: Single axial barbless port

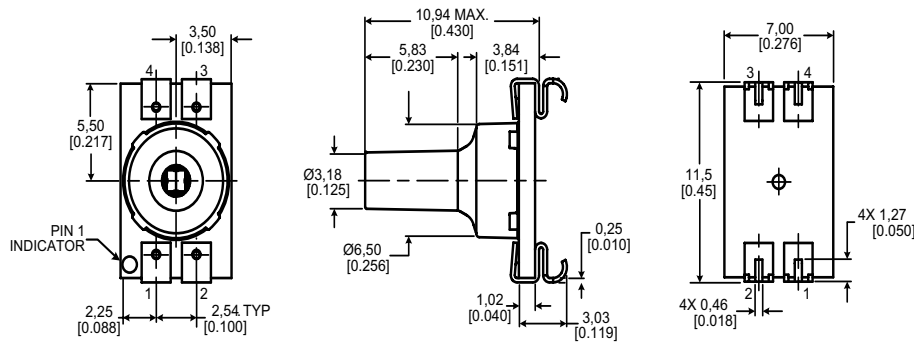

Table 10. Pinout for SMT Packages

| Pin 4 | Pin 3 |
|---------|-------|
| Vout+ | GND |
| Pin 1 | Pin 2 |
| Vsupply | Vout- |

PN: Low-profile port



ADDITIONAL INFORMATION

The following associated literature is available at sensing.honeywell.com:

- Board Mount Pressure Sensors Line Guide
- Airflow, Force, and Pressure Sensors Product Range Guide
- Product Installation Instructions
- Product Nomenclature Tree and Order Guide
- Selection Guides
- Application-specific Information

Find out more

Honeywell serves its customers through a worldwide network of sales offices, representatives and distributors. For application assistance, current specifications, pricing or name of the nearest Authorized Distributor, contact your local sales office.

To learn more about Honeywell's sensing and control products, call **+1-815-235-6847** or **1-800-537-6945**, visit **sensing.honeywell.com**, or e-mail inquiries to **info.sc@honeywell.com**

Sensing and Control
Honeywell
1985 Douglas Drive North
Golden Valley, MN 55422
honeywell.com

⚠ WARNING

PERSONAL INJURY

DO NOT USE these products as safety or emergency stop devices or in any other application where failure of the product could result in personal injury.

Failure to comply with these instructions could result in death or serious injury.

⚠ WARNING

MISUSE OF DOCUMENTATION

- The information presented in this product sheet is for reference only. Do not use this document as a product installation guide.
- Complete installation, operation, and maintenance information is provided in the instructions supplied with each product.

Failure to comply with these instructions could result in death or serious injury.

WARRANTY/REMEDY

Honeywell warrants goods of its manufacture as being free of defective materials and faulty workmanship. Honeywell's standard product warranty applies unless agreed to otherwise by Honeywell in writing; please refer to your order acknowledgement or consult your local sales office for specific warranty details. If warranted goods are returned to Honeywell during the period of coverage, Honeywell will repair or replace, at its option, without charge those items it finds defective. **The foregoing is buyer's sole remedy and is in lieu of all other warranties, expressed or implied, including those of merchantability and fitness for a particular purpose. In no event shall Honeywell be liable for consequential, special, or indirect damages.**

While we provide application assistance personally, through our literature and the Honeywell website, it is up to the customer to determine the suitability of the product in the application.

Specifications may change without notice. The information we supply is believed to be accurate and reliable as of this printing. However, we assume no responsibility for its use.

Honeywell



Компания «ЭлектроПласт» предлагает заключение долгосрочных отношений при поставках импортных электронных компонентов на взаимовыгодных условиях!

Наши преимущества:

- Оперативные поставки широкого спектра электронных компонентов отечественного и импортного производства напрямую от производителей и с крупнейших мировых складов;
- Поставка более 17-ти миллионов наименований электронных компонентов;
- Поставка сложных, дефицитных, либо снятых с производства позиций;
- Оперативные сроки поставки под заказ (от 5 рабочих дней);
- Экспресс доставка в любую точку России;
- Техническая поддержка проекта, помощь в подборе аналогов, поставка прототипов;
- Система менеджмента качества сертифицирована по Международному стандарту ISO 9001;
- Лицензия ФСБ на осуществление работ с использованием сведений, составляющих государственную тайну;
- Поставка специализированных компонентов (Xilinx, Altera, Analog Devices, Intersil, Interpoint, Microsemi, Aeroflex, Peregrine, Syfer, Eurofarad, Texas Instrument, Miteq, Cobham, E2V, MA-COM, Hittite, Mini-Circuits, General Dynamics и др.);

Помимо этого, одним из направлений компании «ЭлектроПласт» является направление «Источники питания». Мы предлагаем Вам помощь Конструкторского отдела:

- Подбор оптимального решения, техническое обоснование при выборе компонента;
- Подбор аналогов;
- Консультации по применению компонента;
- Поставка образцов и прототипов;
- Техническая поддержка проекта;
- Защита от снятия компонента с производства.



Как с нами связаться

Телефон: 8 (812) 309 58 32 (многоканальный)

Факс: 8 (812) 320-02-42

Электронная почта: org@eplast1.ru

Адрес: 198099, г. Санкт-Петербург, ул. Калинина, дом 2, корпус 4, литера А.