

Middle Power Class-D Speaker Amplifiers

Analog Input / BTL Output

Class-D Speaker Amplifier



BD5413EFV

No.10075EBT01

●Description

BD5413EFV is a 5W + 5W stereo class-D power amplifier specifically developed for low power consumption and low heat generation applications like powered speakers. BD5413EFV employs the state-of-the-art BCD (Bipolar, CMOS and DMOS) process technology to eliminate a turn-on resistance in the output power stage and an internal loss due to a wiring resistance as much as possible, achieving a high performance of 80% (4W + 4W output with a load resistance of 8Ω). In addition, BD5413EFV employs a compact power package which dissipates heat via the rear to achieve low power consumption and low heat generation so that the need for connecting an external heat radiator can be eliminated up to a total output of 12.8W. This product meets the needs for compact, thin sound generation systems and powerful, high-quality sound reproduction.

●Features

- 1) Small output noise voltage capable of achieving a high S/N set
Input conversion noise voltage = $2.8\mu\text{Vrms}$
A bipolar differential is used for input amplifier to eliminate 1/f noise.
- 2) Support of power supply voltage ranging from 6V to 10.5V
A supply voltage range is supported that matches an AC adaptor or battery cell driven set.
When a set is battery driven, its operating time can be extended by means of a high performance class-D amplifier.
- 3) Support of low current consumption mode
A circuit current in shut-down mode is $1\mu\text{A}$ or less.
- 4) Built-in soft muting function for reducing pop at shut-down ON or OFF
When a signal is present, its smooth envelope waveform is realized owing to this function.
In addition, when no signal is present, pop generation is eliminated.
A transit time can be adjusted easily through the use of an external capacitor.
- 5) Realization of high efficiency and low heat generation
Efficiency = 80% (4W+4W ($V_{CC}=9\text{V}$, $R_L=8\Omega$) output can be made without using an external heat radiator.)
A compact power package HTSSOP-B24 (7.8mm x 7.6mm) is employed.
- 6) Built-in function for reducing pop generation at disconnection from the outlet
- 7) Support of function for sampling frequency selection
An internal PWM sampling frequency can be selected from three frequencies (200kHz, 250kHz and 300kHz).
Countermeasures against interference (beat noise) due to a switching power source can be taken as needed.
- 8) Realization of high reliability
Countermeasures against short-circuits due to output terminals shorted to V_{CC} or ground can be taken (support of automatic recovery).
A temperature protection circuit is incorporated (support of automatic recovery).
- 9) Support of ERROR pin
ERROR output takes place as a warning which indicates an error.
(short-circuits due to output terminals shorted to V_{CC} or ground, or IC high temperature abnormality).

● Absolute maximum ratings

A circuit must be designed and evaluated not to exceed absolute maximum rating in any cases and even momentarily, to prevent reduction in functional performances and thermal destruction of a semiconductor product and secure useful life and reliability.

The following values assume $T_a = 25^\circ\text{C}$. For latest values, refer to delivery specifications.

Parameter	Symbol	Ratings	Unit	Conditions
Supply voltage	VCC	+15	V	Pin 3, 5, 10, 12, 16, 21 (Note 1,2)
Power dissipation	Pd	1.1	W	(Note 3)
		2.8	W	(Note 4)
Input voltage for signal pin	VIN	-0.2 to Vcc+0.2	V	Pin 23, 24 (Note 1)
Input voltage for control pin	VCONT	-0.2 to Vcc+0.2	V	Pin 14, 15 (Note 1)
Operating temperature range	Topr	-40 to +85	°C	
Storage temperature range	Tstg	-55 to +150	°C	
Maximum junction temperature	Tjmax	+150	°C	

(Note 1) A voltage that can be applied with reference to GND (pins 1, 7, 8, 13, 18 and 19)

(Note 2) Pd and Tjmax=150°C must not be exceeded.

(Note 3) 70mm × 70mm × 1.6mm FR4 One-sided glass epoxy board (Back copper foil 0%) installed.

If used under $T_a = 25^\circ\text{C}$ or higher, reduce 8.8 mW for increase of every 1°C. The board is provided with thermal via.

(Note 4) 70mm × 70mm × 1.6mm FR4 Both-sided glass epoxy board (Back copper foil 100%) installed.

If used under $T_a = 25^\circ\text{C}$ or higher, reduce 22.4 mW for increase of every 1°C. The board is provided with thermal via.

● Operating conditions

The temperature (T_a) is 25°C . For the latest temperature, refer to the delivery specifications.

Parameter	Symbol	Ratings	Unit	Conditions
Supply voltage	VCC	+6 to +10.5	V	Pin 3, 5, 10, 12, 16, 21
Load resistance	RL	6 to 16	Ω	(Note 5)

(Note 5) This value must not exceed Pd.

● Electrical characteristics

Unless otherwise stated, $T_a = 25^\circ\text{C}$, $V_{cc} = 9\text{V}$, $f_{in} = 1\text{kHz}$, $R_g = 0\Omega$, $R_L = 8\Omega$, $SDX = "H"$ and $FC = "M (OPEN)"$ are assumed. For the latest values, refer to the delivery specifications.

Parameter	Symbol	Limits	Unit	Conditions
Whole circuit				
Circuit current 1 (sampling mode)	ICC1	12	mA	No signal, no load
Circuit current 2 (mute mode)	ICC2	1	μA	SDX = "L"
Control				
Input voltage with SDX pin set to "H"	VIHSDX	2.5 to 9	V	Sampling state
Input voltage with SDX pin set to "L"	VILSDX	0 to 0.5	V	Shut-down state
Input voltage with FC pin set to "H"	VIHFC	8.2 to 9	V	Setting of $F_s = 300\text{kHz}$
Input voltage with FC pin set to "M"	VIMFC	3.8 to 5.2	V	Setting of $F_s = 250\text{kHz}$
Input voltage with FC pin set to "L"	VILFC	0 to 0.8	V	Setting of $F_s = 200\text{kHz}$
Audio output				
Voltage gain	Gv	30	dB	$P_o = 1\text{W}$
Maximum output power 1 (Note 6)	PO1	4	W	THD+N = 10%, $R_L = 8\Omega$
Maximum output power 2 (Note 6)	PO2	5	W	THD+N = 10%, $R_L = 6\Omega$
Total harmonic distortion ratio (Note 6)	THD	0.2	%	$P_o = 1\text{W}$, BW=20Hz to 20kHz
Crosstalk	CT	65	dB	$P_o = 1\text{W}$, $R_g = 0\Omega$, BW = IHF-A
Output noise voltage (sampling mode)	VNO	90	μVrms	$R_g = 0\Omega$, BW = IHF-A
Residual noise voltage (mute mode)	VNOM	1	μVrms	$R_g = 0\Omega$, BW = IHF-A, MUTEX = "L"
Internal sampling clock frequency	Fs	200	kHz	FC = L FC = M(OPEN) FC = H
		250		
		300		

(Note 6) The rated values of items above indicate average performances of the device, which largely depend on circuit layouts, components, and power supplies. The reference values are those applicable to the device and components directly installed on a board specified by us.

●Electrical characteristic curves (Ta=25°C) (Reference data)

(1) Under Stereo Operation (RL=8Ω)

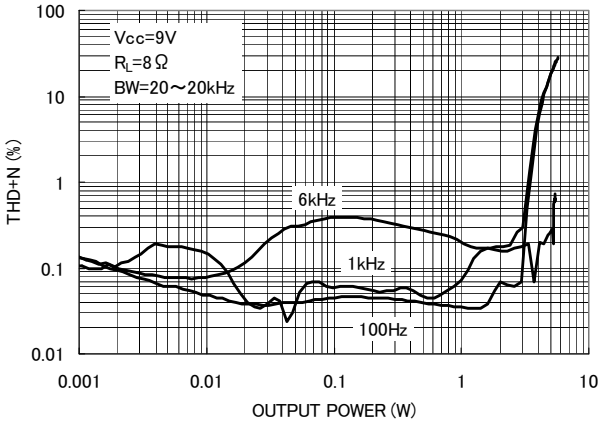

Fig. 1 THD+N - Output Power

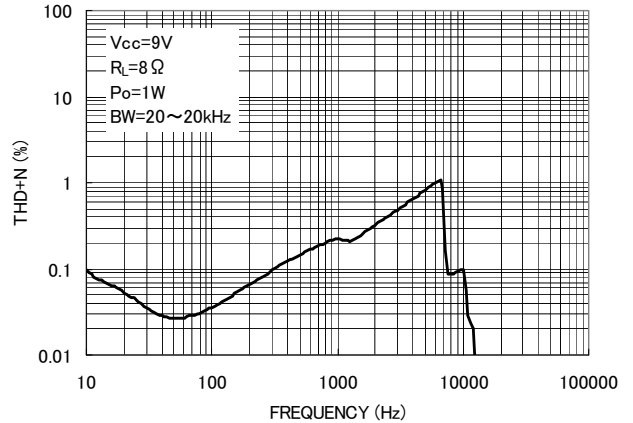

Fig. 2 THD+N - Frequency

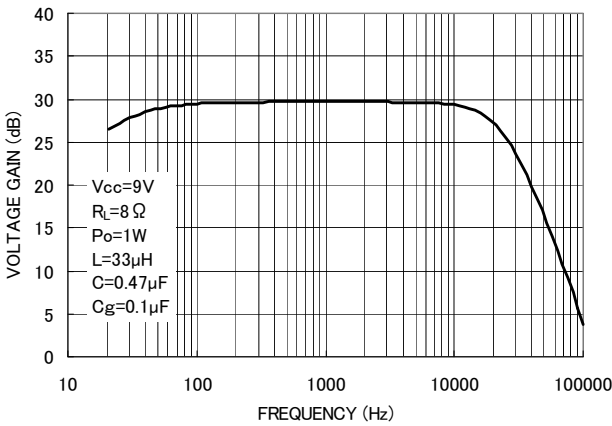

Fig. 3 Voltage Gain - Frequency

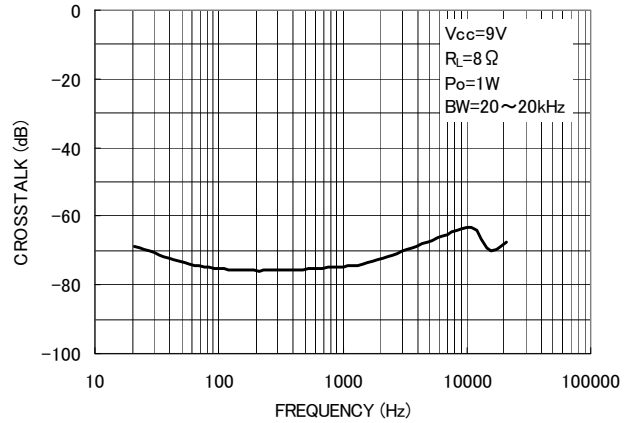

Fig. 4 Crosstalk - Frequency

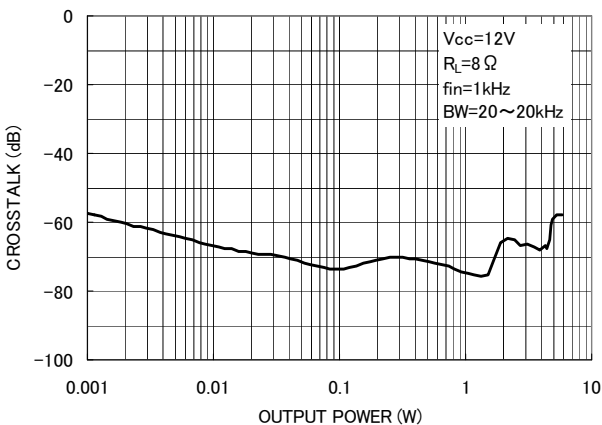

Fig. 5 Crosstalk - Output Power

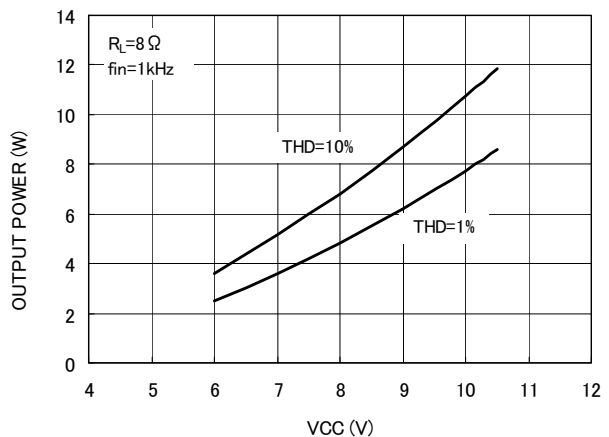

Fig. 6 Output Power - Supply Voltage

●Electrical characteristic curves (Reference data) – Continued

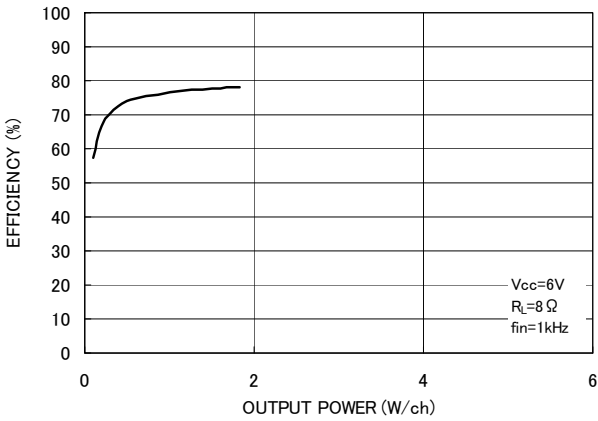

Fig. 7 Efficiency - Output Power

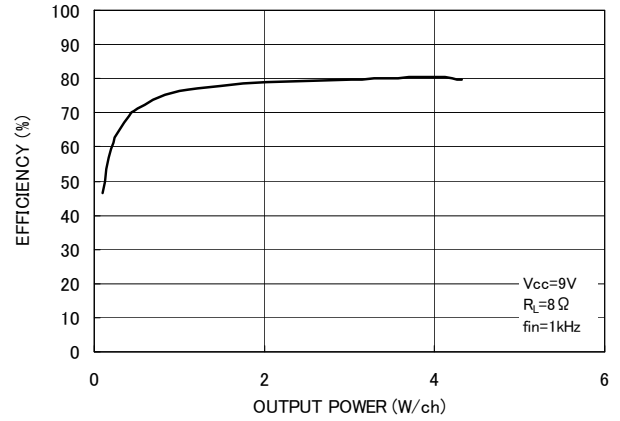

Fig. 8 Efficiency - Output Power

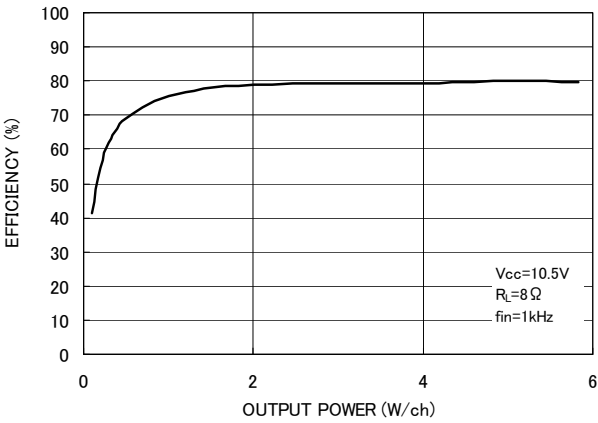

Fig. 9 Efficiency - Output Power

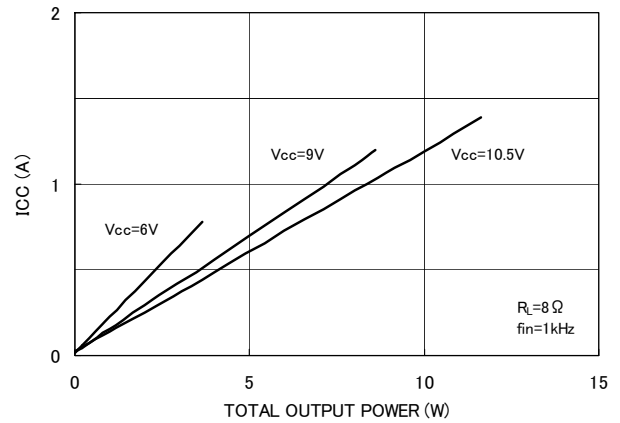

Fig. 10 Current Consumption - Output Power

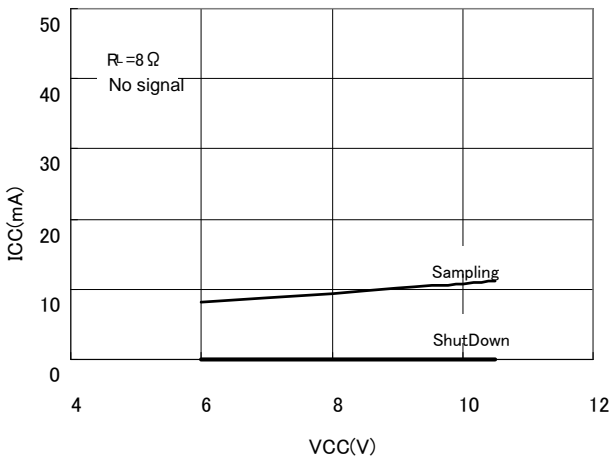

Fig. 11 50 Current Consumption - Supply Voltage

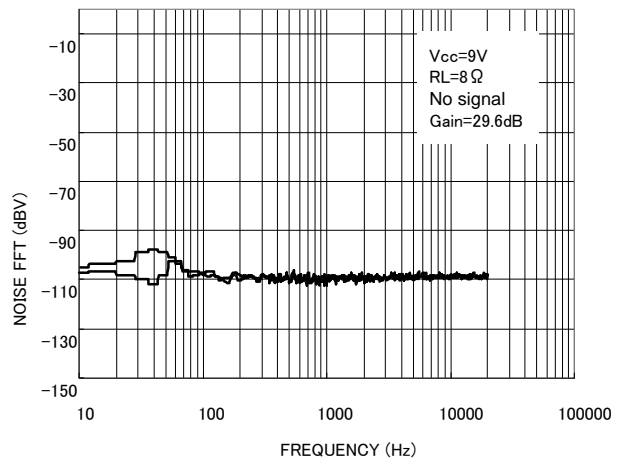

Fig. 12 Output Noise Voltage FFT

●Electrical characteristic curves (Reference data) – Continued

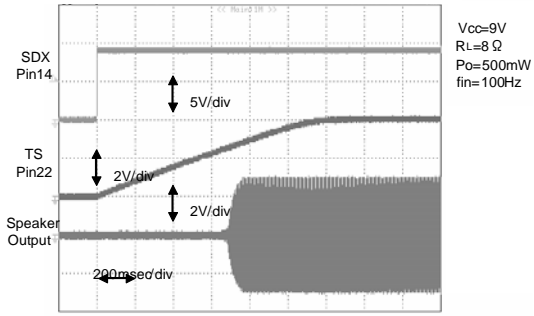

Fig. 13 Waveform at Soft Mute Reset

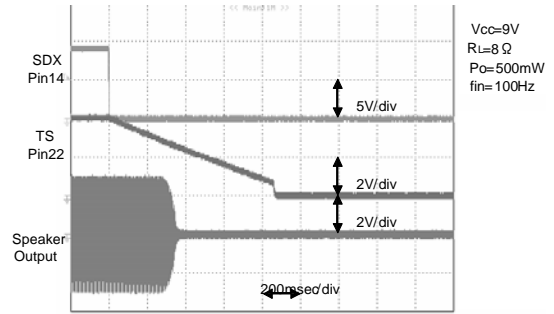

Fig. 14 Waveform at Soft Mute

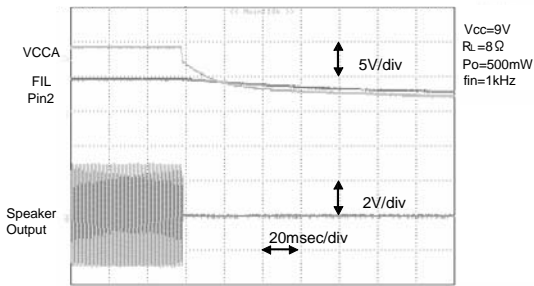

Fig. 15 Waveform at Instantaneous Power Interruption (20msec/div)

●Electrical characteristic curves (Reference data) – Continued

(2) Under Stereo Operation ($R_L=16\ \Omega$)

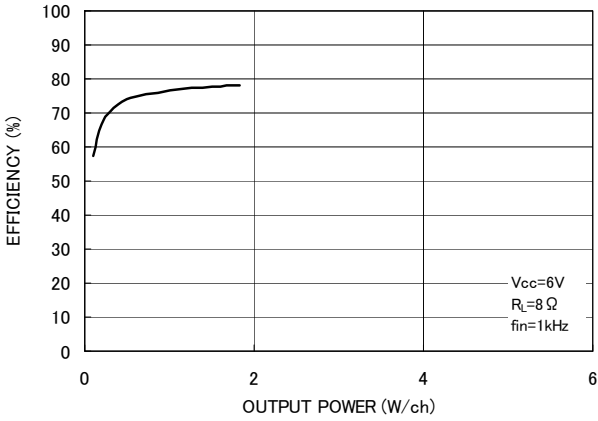

Fig. 16 Output Power - Supply Voltage

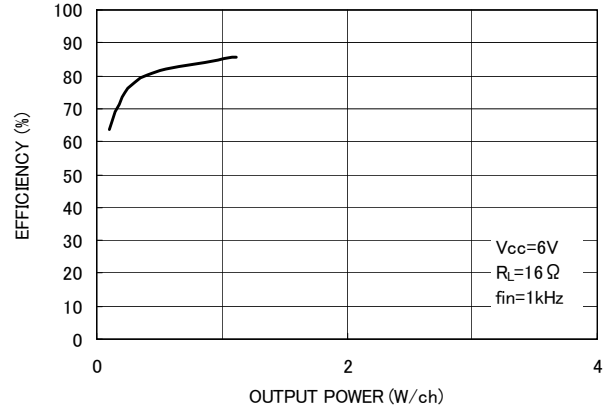

Fig. 17 Efficiency - Output Power

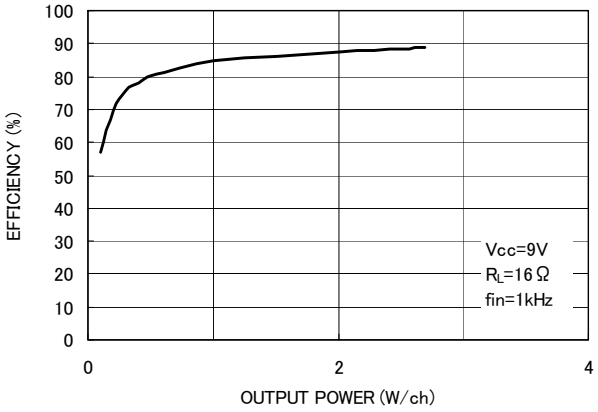

Fig. 18 Efficiency - Output Power

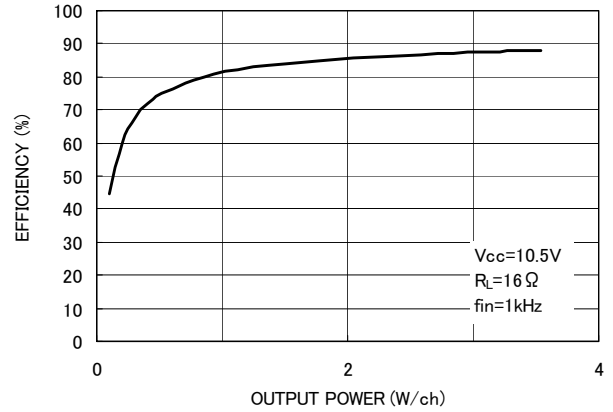

Fig. 19 Efficiency - Output Power

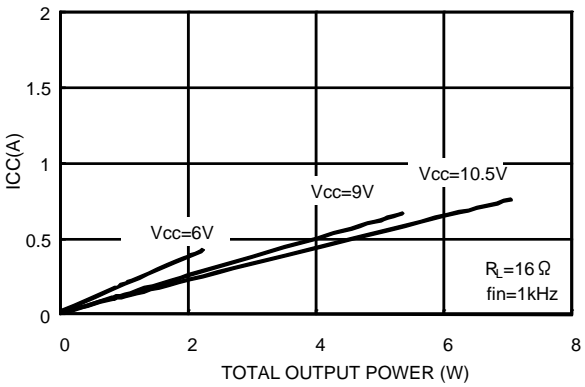

Fig. 20 Current Consumption - Output Power

●Electrical characteristic curves (Reference data) – Continued

(3) Under Stereo Operation ($R_L=6\Omega$)

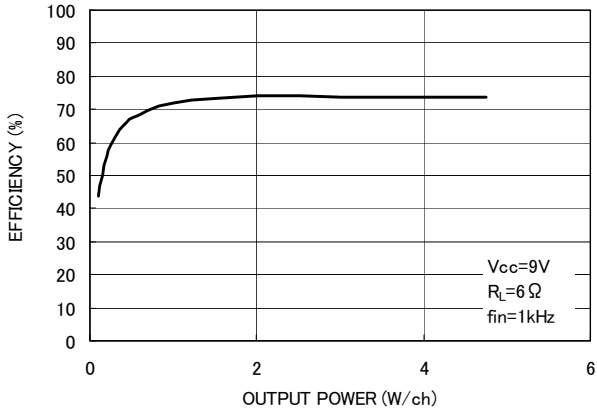

Fig. 21 Output Power - Supply Voltage

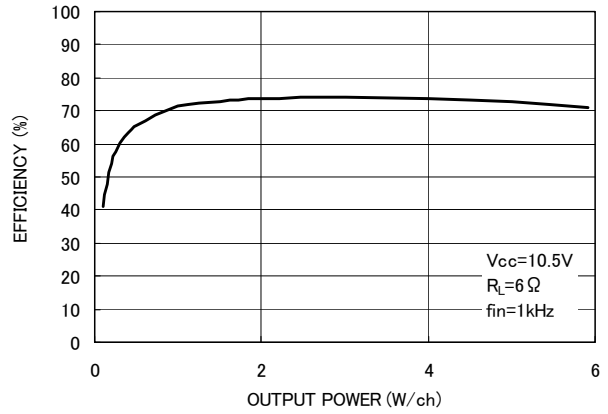

Fig. 22 Efficiency - Output Power

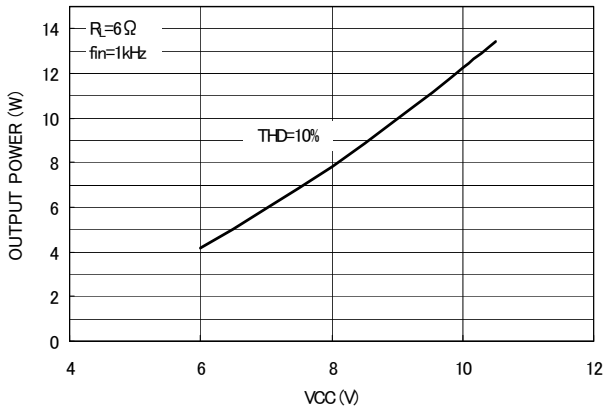

Fig. 23 Efficiency - Output Power

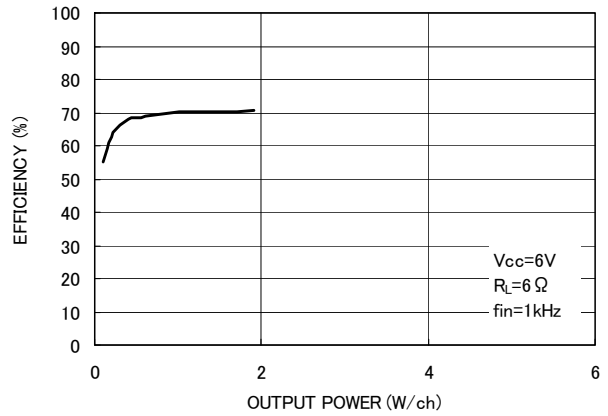

Fig. 24 Efficiency - Output Power

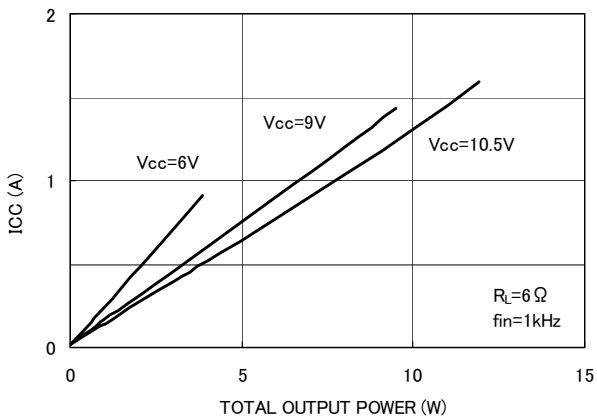

Fig. 25 Current Consumption - Output Power

● Pin Assignment Diagram

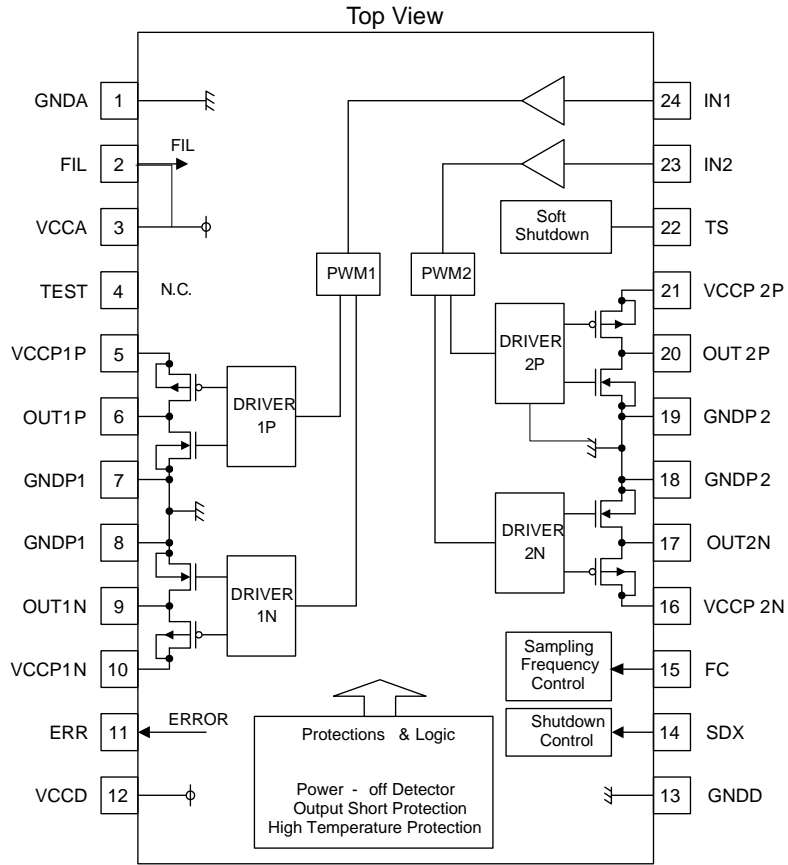

Fig. 26 Pin Assignment

● Outer Dimensions and Inscriptions

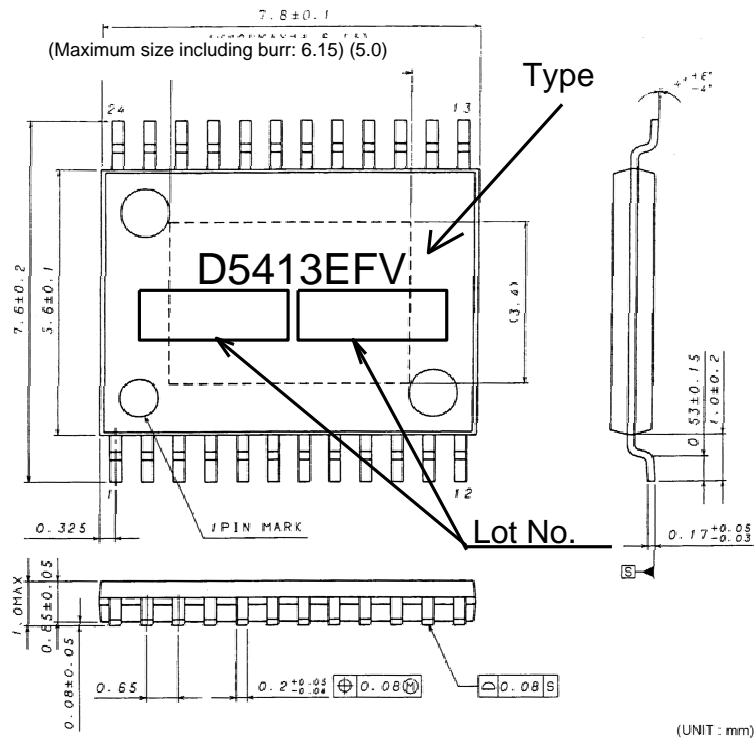
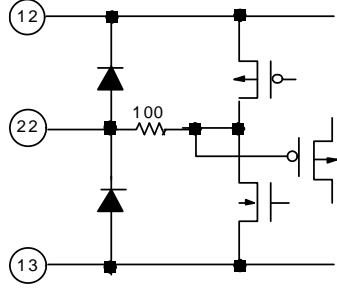
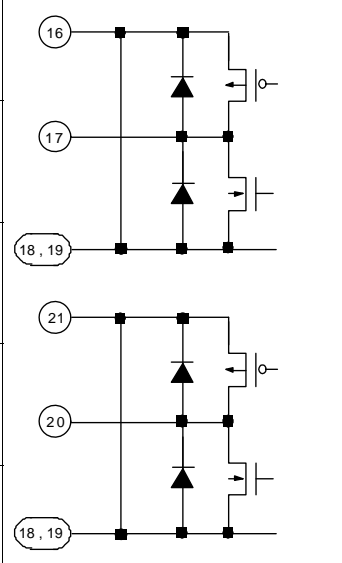
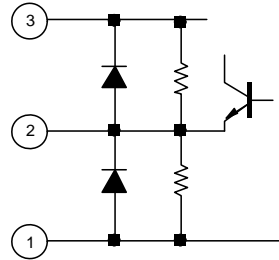

Fig. 27 Outer Dimensions and Inscriptions of the HTSSOP-B24 Package

●Pin configuration (Pin Voltage: Typical Value)

No.	Symbol	Pin voltage	Pin description	Internal equalizing circuit
24 23	IN1 IN2	1/2V _{CC}	ch1: Analog signal input pin ch2: Analog signal input pin Input an audio signal via a capacitor.	
5	VCCP1P	V _{CC}	ch1: Positive power system power supply pin	
6	OUT1P	V _{CC} to 0V	ch1: Positive PWM signal output pin Make connection to the output LPF.	
7, 8	GNDDP1	0V	ch1: Power GND pin	
9	OUT1N	V _{CC} to 0V	ch1: Negative PWM signal output pin Make connection to the output LPF.	
10	VCCP1N	V _{CC}	ch1: Negative power system power supply pin	
11	ERROR	H: 5V L: 0V	Error output pin Pin for notifying an operation error H: Error L: Normal operation	
12	VCCD	V _{CC}	Control power supply pin	
13	GNDD	0V	Control GND pin	
14	SDX	-	Shut-down control pin H: Shut-down OFF L: Shut-down ON	

●Pin configuration - Continued

No.	Symbol	Pin voltage	Pin description	Internal equalizing circuit
4	TEST	Vcc	Do not use the TEST pin. Keep this pin open or connect it to VCC for regular use.	
22	TS	0 to 4V	Shut-down ON/OFF Constant setting pin Connect a capacitor.	
16	VCCP2N	Vcc	ch2: Negative power system power supply pin	
17	OUT2N	Vcc to 0V	ch2: Negative PWM signal output pin Make connection to the output LPF.	
18, 19	GNDP2	0V	ch2: Power GND pin	
20	OUT2P	Vcc to 0V	ch2: Positive PWM signal output pin Make connection to the output LPF.	
21	VCCP2P	Vcc	ch2: Positive power system power supply pin	
3	VCCA	Vcc	Analog system power supply pin	
2	FILA	1/2Vcc	Analog signal system bias pin Connect a capacitor.	
1	GNDA	0V	Analog signal system GND pin	

●Application Circuit Diagram

(1)Application Circuit Diagram with a Load of 8Ω for Stereo Operation

• Vcc=6V to 10.5V

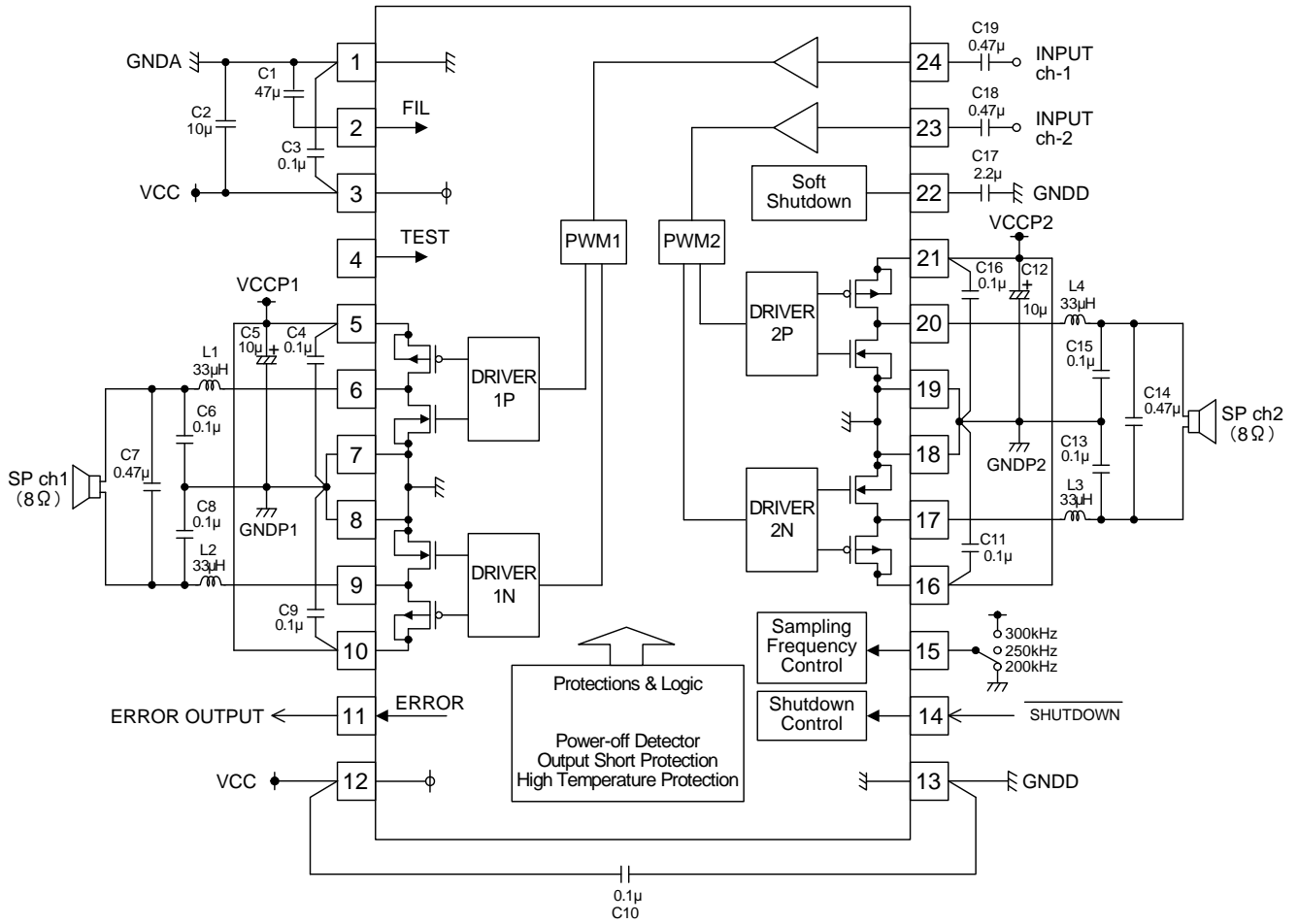

Fig.28 Circuit Diagram with a Load of 8Ω for Stereo Operation

(2)BOMs of Boards for Stereo Operation

Table 1 BOMs of Boards with Loads of 8Ω, 6Ω and 16Ω for Stereo Operation

No.	Item	Part Number	Vendor	Configuration		Value	Rated voltage	Tolerance	Temperature characteristics	Quantity	Reference
				mm	inch						
1	IC	BD5413EFV	ROHM	HTSSOP-B24		-	-	-	-	1	IC1
2	C	GRM32EB31A476KE20	MURATA	3225	1210	47μF	10V	±10%	±10%	1	C1
3	C	GRM21BB31C106KE15	MURATA	2012	0805	10μF	16V	±10%	±10%	1	C2
4	C	GRM188B11C104KA01	MURATA	1608	0603	0.1μF	16V	±10%	±10%	6	C3, C4, C9, C10, C11, C16
5	C	GRM188B30J225KE18	MURATA	1608	0603	2.2μF	6.3V	±10%	±10%	1	C17
6	C	GRM188B11C474KA87	MURATA	1608	0603	0.47μF	16V	±10%	±10%	2	C18, C19
7	C	EMZA350ADA100ME61G	CHEM1-00N	5.3x5.3		10μF	35V	±20%	+20%, -25%	2	C5, C12

BOM of Board with a Load Resistance of 8Ω

No.	Item	Part Number	Vendor	Configuration		Value	Rated voltage	Tolerance	Temperature characteristics	Quantity	Reference
				mm	inch						
8	C	GRM188B11C104KA01	MURATA	1608	0603	0.1μF	16V	±10%	±10%	4	C6, C8, C13, C15
9	C	GRM188B11C474KA87	MURATA	1608	0603	0.47μF	16V	±10%	±10%	2	C7, C14

No.	Item	Part Number	Vendor	Configuration		Value	Tolerance	DC Resistance	Rated DC Current	Quantity	Reference
				mm							
10	L	TSL0808RA-330K1R4-PF	TDK	Φ8.5, 8.3		33μH	±10%	92mΩmax	1.4A max	4	L1, L2, L3, L4

BOM of Board with a Load Resistance of 6Ω

No.	Item	Part Number	Vendor	Configuration		Value	Rated voltage	Tolerance	Temperature characteristics	Quantity	Reference
				mm	inch						
8	C	GRM188B11C474KA87	MURATA	1608	0603	0.47μF	16V	±10%	±10%	4	C6, C8, C13, C15
9	C	GRM188B11C474KA87	MURATA	1608	0603	0.47μF	16V	±10%	±10%	2	C7, C14

No.	Item	Part Number	Vendor	Configuration		Value	Tolerance	DC Resistance	Rated DC Current	Quantity	Reference
				mm							
10	L	TSL0808RA-220K1R7-PF	TDK	Φ8.5, 8.3		22μH	±10%	70mΩmax	1.7A max	4	L1, L2, L3, L4

BOM of Board with a Load Resistance of 16Ω

No.	Item	Part Number	Vendor	Configuration		Value	Rated voltage	Tolerance	Temperature characteristics	Quantity	Reference
				mm	inch						
8	C	GRM188B11C104KA01	MURATA	1608	0603	0.01μF	16V	±10%	±10%	4	C6, C8, C13, C15
9	C	GRM188B11C224KA01	MURATA	1608	0603	0.22μF	16V	±10%	±10%	2	C7, C14

No.	Item	Part Number	Vendor	Configuration		Value	Tolerance	DC Resistance	Rated DC Current	Quantity	Reference
				mm							
10	L	TSL0808RA-680K1R0-PF	TDK	Φ8.5, 8.3		68μH	±10%	160mΩmax	1A max	4	L1, L2, L3, L4

●Notes for use

1. About absolute maximum ratings

If an applied voltage or an operating temperature exceeds an absolute maximum rating, it may cause destruction of a device. A result of destruction, whether it is short mode or open mode, is not predictable. Therefore, provide a physical safety measure such as fuse, against a special mode that may violate conditions of absolute maximum ratings.

2. About power supply line

As return of current regenerated by back EMF of output coil happens, take steps such as putting capacitor between power supply and GND as a electric pathway for the regenerated current. Be sure that there is no problem with each property such as emptied capacity at lower temperature regarding electrolytic capacitor to decide capacity value. If the connected power supply does not have sufficient current absorption capacity, regenerative current will cause the voltage on the power supply line to rise, which combined with the product and its peripheral circuitry may exceed the absolute maximum ratings. It is recommended to implement a physical safety measure such as the insertion of a voltage clamp diode between the power supply and GND pins.

3. Potential of GND (1, 7, 8, 13, 18 and 19 pins)

Potential of the GND terminal must be the lowest under any operating conditions.

4. About thermal design

Perform thermal design with sufficient margins, in consideration of maximum power dissipation P_d under actual operating conditions. This product has an exposed frame on the back of the package, and it is assumed that the frame is used with measures to improve efficiency of heat dissipation. In addition to front surface of board, provide a heat dissipation pattern as widely as possible on the back also.

A class-D power amplifier has heat dissipation efficiency far higher than that of conventional analog power amplifier and generates less heat. However, extra attention must be paid in thermal design so that a power dissipation P_{diss} should not exceed the maximum power dissipation P_d .

$$\text{Maximum power dissipation} \quad P_d = P_o \frac{T_{jmax} - T_a}{\theta_{ja}} \quad [W]$$

$$\text{Power dissipation} \quad P_{diss} = P_o \left(\frac{1}{\eta} - 1 \right) \quad [W]$$

T_{jmax} : Maximum temperature junction = 150[°C]

T_a : Operating ambient temperature [°C]

θ_{ja} : Package thermal resistance [°C/W]

P_o : Output power [W]

η : Efficiency

5. About operations in strong electric field

Note that the device may malfunction in a strong electric field.

6. Thermal shutdown (TSD) circuit

This product is provided with a built-in thermal shutdown circuit. When the thermal shutdown circuit operates, the output transistors are placed under open status. The thermal shutdown circuit is primarily intended to shut down the IC avoiding thermal runaway under abnormal conditions with a chip temperature exceeding $T_{jmax} = 150^\circ\text{C}$, and is not intended to protect and secure an electrical appliance. Accordingly, do not use this circuit function to protect a customer's electrical appliance.

7. About shorting between pins and installation failure

Be careful about direction and displacement of an IC when installing it onto the board. Faulty installation may destroy the IC when the device is energized. In addition, a foreign matter getting in between IC pins, pins and power supply, and pins and GND may cause shorting and destruction of the IC.

8. About power-on or power-off sequence

Set the SDX pin (pin 14) to "L" level before initiating the power-on sequence. Similarly, set the SDX pin (pin 14) to "L" level before initiating the power-off sequence. If such a setting is made, pop reduction is achieved at power-on or power-off sequence. In addition, note that all power supply pins shall be made active or inactive at the same time.

9. About error output pin (pin 11)

When a high temperature protection function or VCC/GND shorting protection function is activated, an error flag is output via an error output pin. Because the error output pin is primarily intended to indicate the state of BD5413EFV and is available only to protect BD5413EFV, it cannot be used for any other purposes.

10. About TEST pin (pin 4)

Do not use the TEST pin. Keep this pin open or connect it to VCC for regular use.

●Ordering part number

B	D
---	---

Part No
BD.

5	4	1	3
---	---	---	---

Part No.
5413

E	F	V
---	---	---

Package
EFV:HTSSOP-B24

E	2
---	---

Packaging and forming specification
E2: Embossed tape and reel

HTSSOP-B24

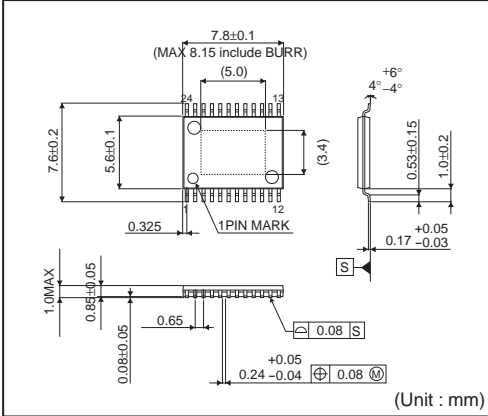

<Tape and Reel information>

Tape	Embossed carrier tape (with dry pack)
Quantity	2000pcs
Direction of feed	E2 (The direction is the 1pin of product is at the upper left when you hold reel on the left hand and you pull out the tape on the right hand)

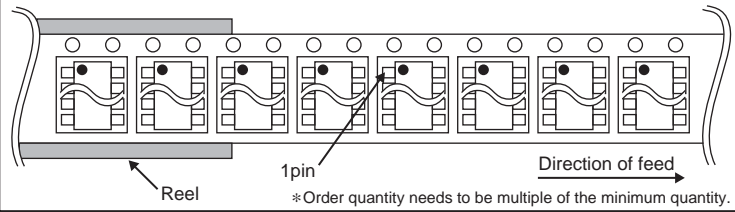

Notes

No copying or reproduction of this document, in part or in whole, is permitted without the consent of ROHM Co.,Ltd.

The content specified herein is subject to change for improvement without notice.

The content specified herein is for the purpose of introducing ROHM's products (hereinafter "Products"). If you wish to use any such Product, please be sure to refer to the specifications, which can be obtained from ROHM upon request.

Examples of application circuits, circuit constants and any other information contained herein illustrate the standard usage and operations of the Products. The peripheral conditions must be taken into account when designing circuits for mass production.

Great care was taken in ensuring the accuracy of the information specified in this document. However, should you incur any damage arising from any inaccuracy or misprint of such information, ROHM shall bear no responsibility for such damage.

The technical information specified herein is intended only to show the typical functions of and examples of application circuits for the Products. ROHM does not grant you, explicitly or implicitly, any license to use or exercise intellectual property or other rights held by ROHM and other parties. ROHM shall bear no responsibility whatsoever for any dispute arising from the use of such technical information.

The Products specified in this document are intended to be used with general-use electronic equipment or devices (such as audio visual equipment, office-automation equipment, communication devices, electronic appliances and amusement devices).

The Products specified in this document are not designed to be radiation tolerant.

While ROHM always makes efforts to enhance the quality and reliability of its Products, a Product may fail or malfunction for a variety of reasons.

Please be sure to implement in your equipment using the Products safety measures to guard against the possibility of physical injury, fire or any other damage caused in the event of the failure of any Product, such as derating, redundancy, fire control and fail-safe designs. ROHM shall bear no responsibility whatsoever for your use of any Product outside of the prescribed scope or not in accordance with the instruction manual.

The Products are not designed or manufactured to be used with any equipment, device or system which requires an extremely high level of reliability the failure or malfunction of which may result in a direct threat to human life or create a risk of human injury (such as a medical instrument, transportation equipment, aerospace machinery, nuclear-reactor controller, fuel-controller or other safety device). ROHM shall bear no responsibility in any way for use of any of the Products for the above special purposes. If a Product is intended to be used for any such special purpose, please contact a ROHM sales representative before purchasing.

If you intend to export or ship overseas any Product or technology specified herein that may be controlled under the Foreign Exchange and the Foreign Trade Law, you will be required to obtain a license or permit under the Law.



Thank you for your accessing to ROHM product informations.
More detail product informations and catalogs are available, please contact us.

ROHM Customer Support System

<http://www.rohm.com/contact/>



Компания «ЭлектроПласт» предлагает заключение долгосрочных отношений при поставках импортных электронных компонентов на взаимовыгодных условиях!

Наши преимущества:

- Оперативные поставки широкого спектра электронных компонентов отечественного и импортного производства напрямую от производителей и с крупнейших мировых складов;
- Поставка более 17-ти миллионов наименований электронных компонентов;
- Поставка сложных, дефицитных, либо снятых с производства позиций;
- Оперативные сроки поставки под заказ (от 5 рабочих дней);
- Экспресс доставка в любую точку России;
- Техническая поддержка проекта, помощь в подборе аналогов, поставка прототипов;
- Система менеджмента качества сертифицирована по Международному стандарту ISO 9001;
- Лицензия ФСБ на осуществление работ с использованием сведений, составляющих государственную тайну;
- Поставка специализированных компонентов (Xilinx, Altera, Analog Devices, Intersil, Interpoint, Microsemi, Aeroflex, Peregrine, Syfer, Eurofarad, Texas Instrument, Miteq, Cobham, E2V, MA-COM, Hittite, Mini-Circuits, General Dynamics и др.);

Помимо этого, одним из направлений компании «ЭлектроПласт» является направление «Источники питания». Мы предлагаем Вам помощь Конструкторского отдела:

- Подбор оптимального решения, техническое обоснование при выборе компонента;
- Подбор аналогов;
- Консультации по применению компонента;
- Поставка образцов и прототипов;
- Техническая поддержка проекта;
- Защита от снятия компонента с производства.



Как с нами связаться

Телефон: 8 (812) 309 58 32 (многоканальный)

Факс: 8 (812) 320-02-42

Электронная почта: org@eplast1.ru

Адрес: 198099, г. Санкт-Петербург, ул. Калинина, дом 2, корпус 4, литера А.