

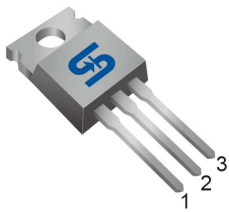

TO-220

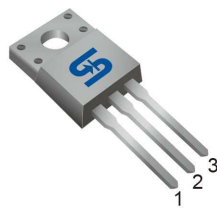

ITO-220



**Pin Definition:**

1. Gate
2. Drain
3. Source

**Key Parameter Performance**

Parameter	Value	Unit
$V_{DS}$	650	V
$R_{DS(on)}$ (max)	3.37	$\Omega$
$Q_g$	13.46	nC

TO-251 (IPAK)

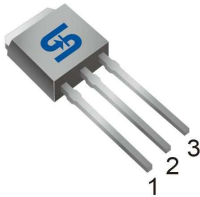

TO-252 (DPAK)

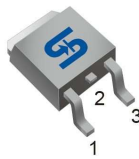

**Application**

- Power Supply.
- Lighting

**Ordering Information**

Part No.	Package	Packing
TSM4NB65CZ C0G	TO-220	50pcs / Tube
TSM4NB65CI C0G	ITO-220	50pcs / Tube
TSM4NB65CH C5G	TO-251	75pcs / Tube
TSM4NB65CP ROG	TO-252	2.5kpcs / 13" Reel

**Note:** "G" denotes for Halogen- and Antimony-free as those which contain <900ppm bromine, <900ppm chlorine (<1500ppm total Br + Cl) and <1000ppm antimony compounds

**Block Diagram**

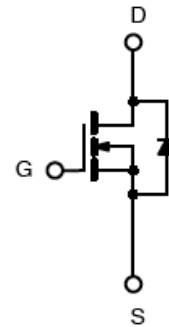

N-Channel MOSFET

**Absolute Maximum Ratings** ( $T_C = 25^\circ\text{C}$  unless otherwise noted)

Parameter	Symbol	Limit			Unit
		IPAK/DPAK	ITO-220	TO-220	
Drain-Source Voltage	$V_{DS}$	650			V
Gate-Source Voltage	$V_{GS}$	$\pm 30$			V
Continuous Drain Current <sup>(Note 1)</sup>	$I_D$	$T_C = 25^\circ\text{C}$			A
		$T_C = 100^\circ\text{C}$			A
Pulsed Drain Current <sup>(Note 2)</sup>	$I_{DM}$	16			A
Single Pulse Avalanche Energy <sup>(Note 3)</sup>	$E_{AS}$	31.2			mJ
Total Power Dissipation @ $T_C = 25^\circ\text{C}$	$P_{TOT}$	50	25	70	W
Operating Junction Temperature	$T_J$	-55 to +150			$^\circ\text{C}$
Storage Temperature Range	$T_{STG}$	-55 to +150			$^\circ\text{C}$



### Thermal Performance

Parameter	Symbol	Limit			Unit
		IPAK/DPAK	ITO-220	TO-220	
Thermal Resistance - Junction to Case	$R_{\theta JC}$	2.5	5	1.78	$^{\circ}C/W$
Thermal Resistance - Junction to Ambient	$R_{\theta JA}$	83	62.5	62.5	$^{\circ}C/W$

### Electrical Specifications ( $T_A=25^{\circ}C$ unless otherwise noted)

Parameter	Conditions	Symbol	Min	Typ	Max	Unit
<b>Static</b> (Note 4)						
Drain-Source Breakdown Voltage	$V_{GS} = 0V, I_D = 250\mu A$	$BV_{DSS}$	650	--	--	V
Drain-Source On-State Resistance	$V_{GS} = 10V, I_D = 2A$	$R_{DS(ON)}$	--	2.7	3.37	$\Omega$
Gate Threshold Voltage	$V_{DS} = V_{GS}, I_D = 250\mu A$	$V_{GS(TH)}$	2.5	3.6	4.5	V
Zero Gate Voltage Drain Current	$V_{DS} = 650V, V_{GS} = 0V$	$I_{DSS}$	--	--	1	$\mu A$
Gate Body Leakage	$V_{GS} = \pm 30V, V_{DS} = 0V$	$I_{GSS}$	--	--	$\pm 100$	nA
Forward Transfer Conductance	$V_{DS} = 40V, I_D = 2A$	$g_{fs}$	--	2.6	--	S
<b>Dynamic</b> (Note 5)						
Total Gate Charge	$V_{DS} = 480V, I_D = 4A,$ $V_{GS} = 10V$	$Q_g$	--	13.46	--	nC
Gate-Source Charge		$Q_{gs}$	--	2.98	--	
Gate-Drain Charge		$Q_{gd}$	--	6.66	--	
Input Capacitance	$V_{DS} = 25V, V_{GS} = 0V,$ $f = 1.0MHz$	$C_{iss}$	--	549	--	pF
Output Capacitance		$C_{oss}$	--	75	--	
Reverse Transfer Capacitance		$C_{rss}$	--	18	--	
<b>Switching</b> (Note 6)						
Turn-On Delay Time	$V_{GS} = 10V, I_D = 4A,$ $V_{DD} = 300V, R_G = 25\Omega$	$t_{d(on)}$	--	11	--	ns
Turn-On Rise Time		$t_r$	--	20	--	
Turn-Off Delay Time		$t_{d(off)}$	--	30	--	
Turn-Off Fall Time		$t_f$	--	19	--	
<b>Source-Drain Diode Ratings and Characteristic</b> (Note 4)						
Source Current	Integral reverse diode in the MOSFET	$I_S$	--	--	4	A
Source Current (Pulse)		$I_{SM}$	--	--	16	A
Diode Forward Voltage	$I_S = 4A, V_{GS} = 0V$	$V_{SD}$	--	--	1.13	V

### Notes:

1. Current limited by package
2. Pulse width limited by the maximum junction temperature
3.  $L = 10mH, I_{AS} = 2.4A, V_{DD} = 50V, R_G = 25\Omega, \text{Starting } T_J = 25^{\circ}C$
4. Pulse test:  $PW \leq 300\mu s, \text{duty cycle } \leq 2\%$
5. For DESIGN AID ONLY, not subject to production testing.
6. Switching time is essentially independent of operating temperature.

### Electrical Characteristics Curves

**Output Characteristics**

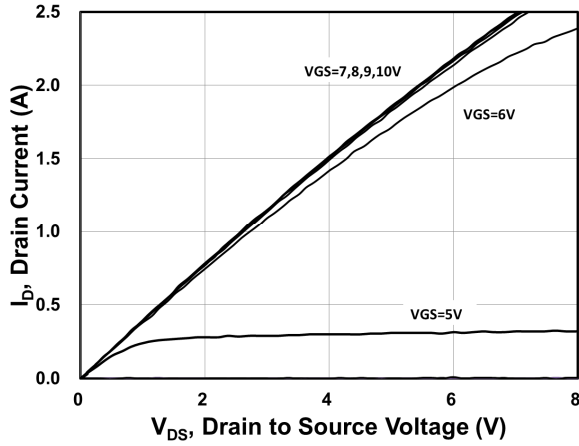

**Transfer Characteristics**

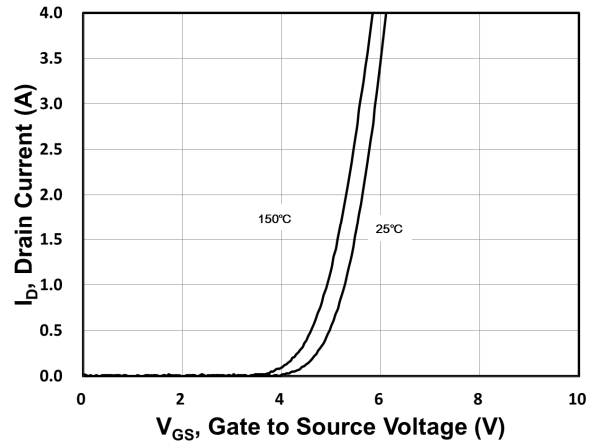

**On-Resistance vs. Drain Current**

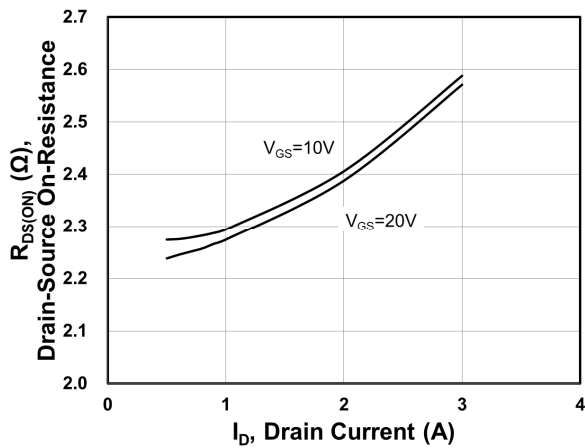

**Gate-Source Voltage vs. Gate Charge**

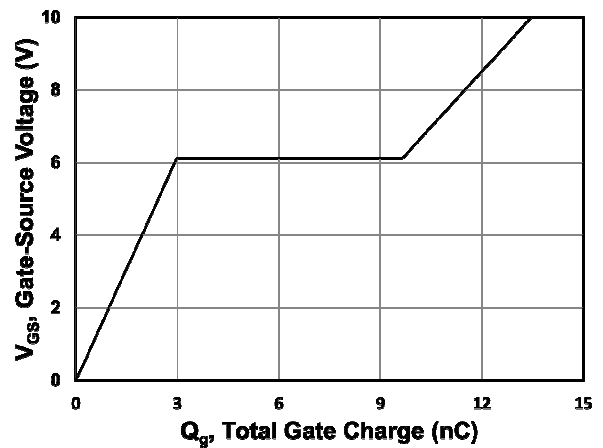

**On-Resistance vs. Junction Temperature**

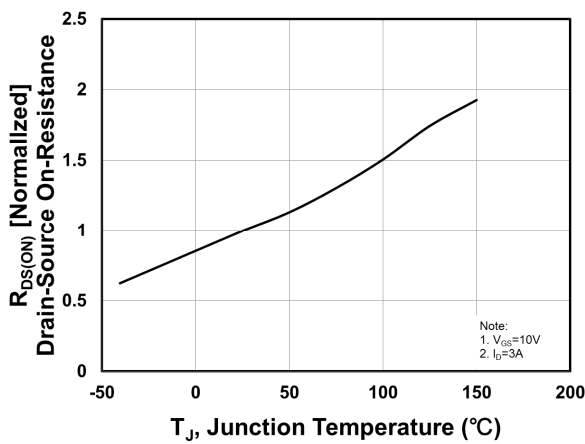

**Source-Drain Diode Forward Current vs. Voltage**

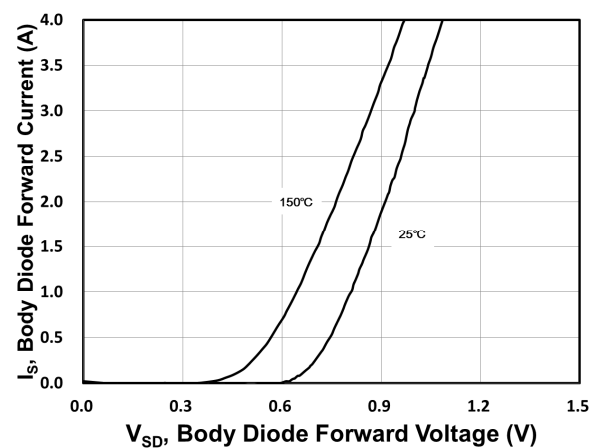

### Electrical Characteristics Curves

Capacitance vs. Drain-Source Voltage

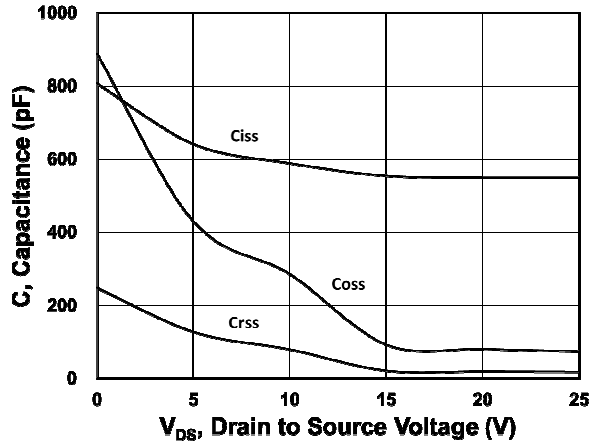

BV<sub>DSS</sub> vs. Junction Temperature

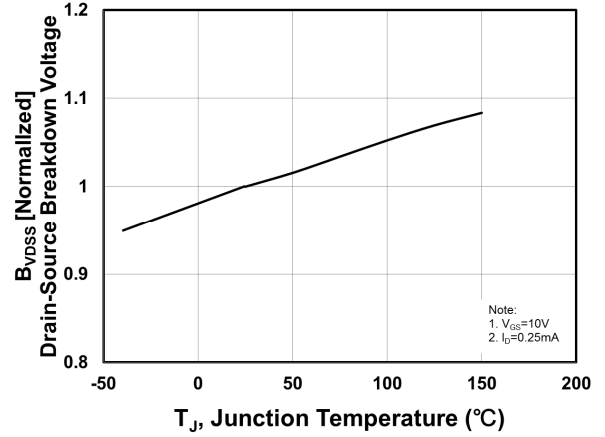

Maximum Safe Operating Area (TO-220)

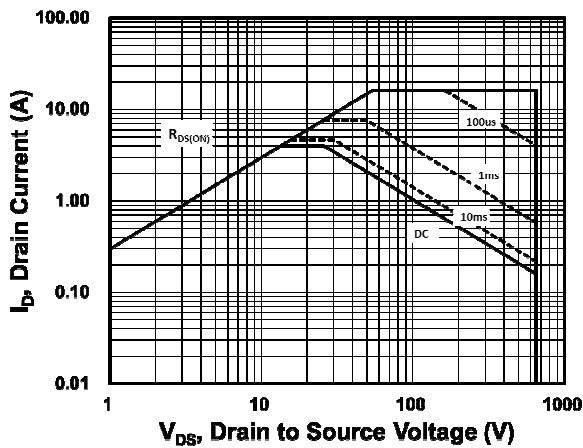

Maximum Safe Operating Area (ITO-220)

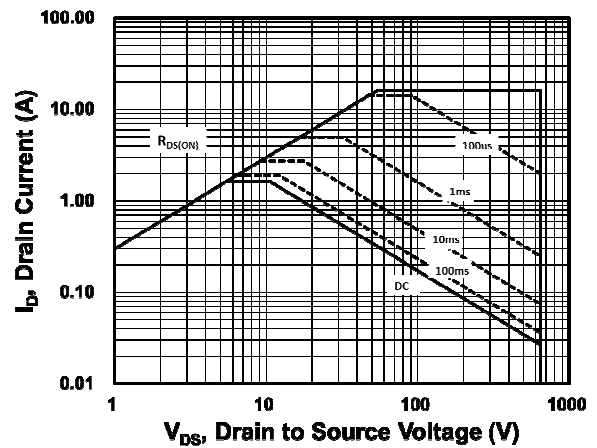

Maximum Safe Operating Area (DPAK/IPAK)

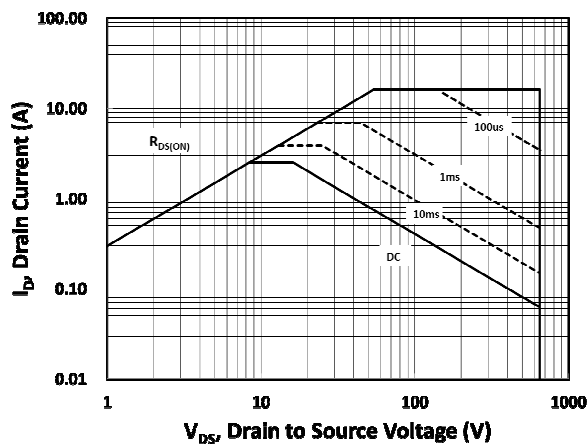

**Electrical Characteristics Curves**

**Normalized Thermal Transient Impedance, Junction-to-Case (TO-220)**

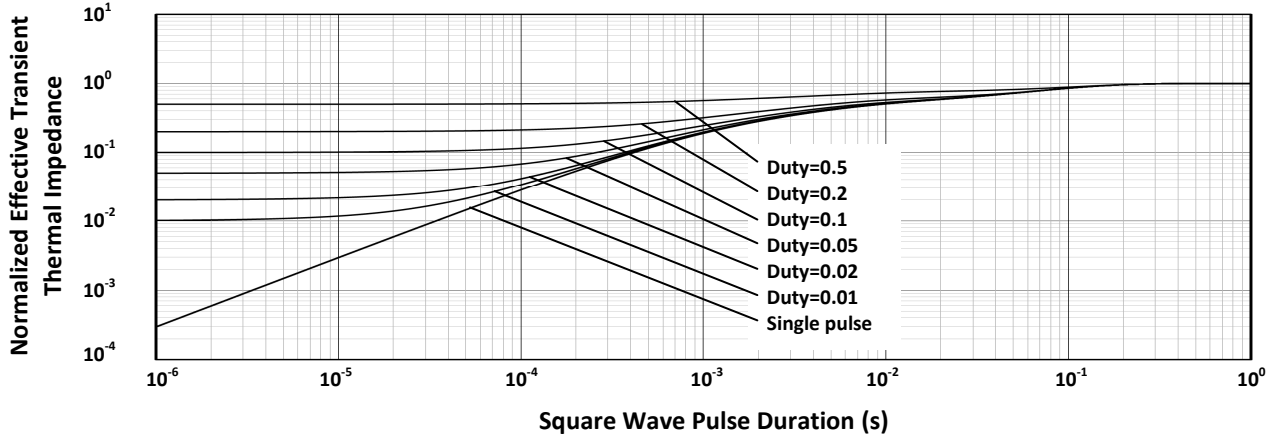

**Normalized Thermal Transient Impedance, Junction-to-Case (ITO-220)**

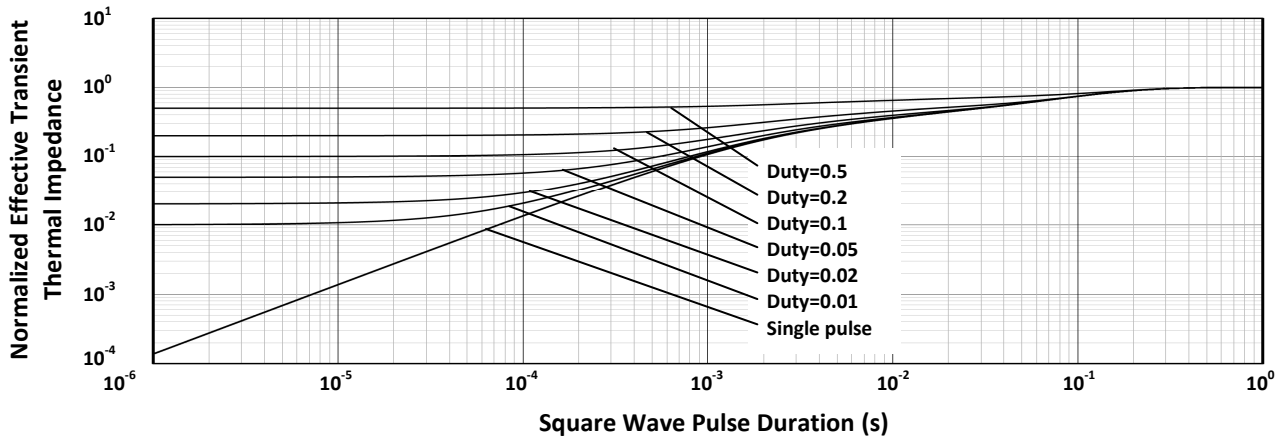

**Normalized Thermal Transient Impedance, Junction-to-Case (DPAK/IPAK)**

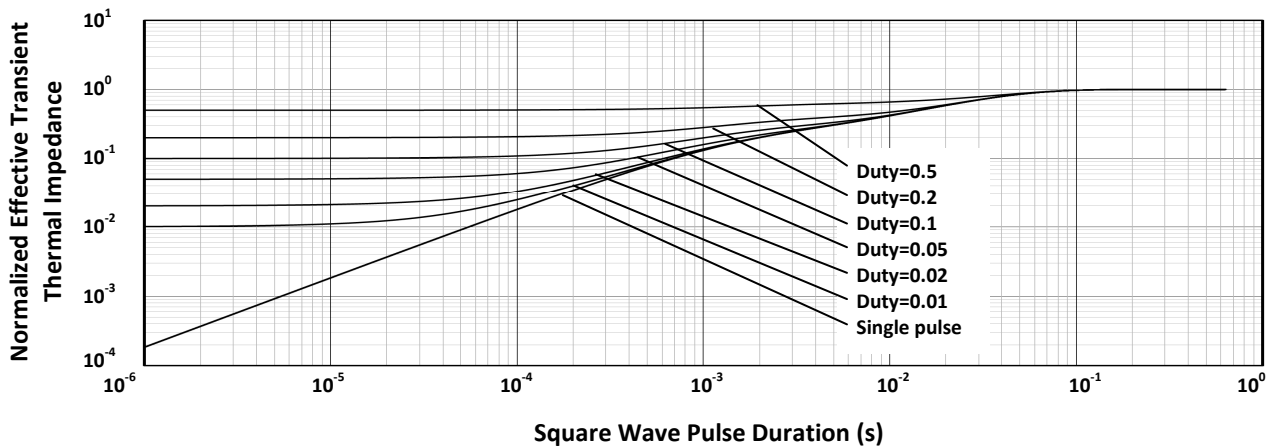



**TO-220 Mechanical Drawing**

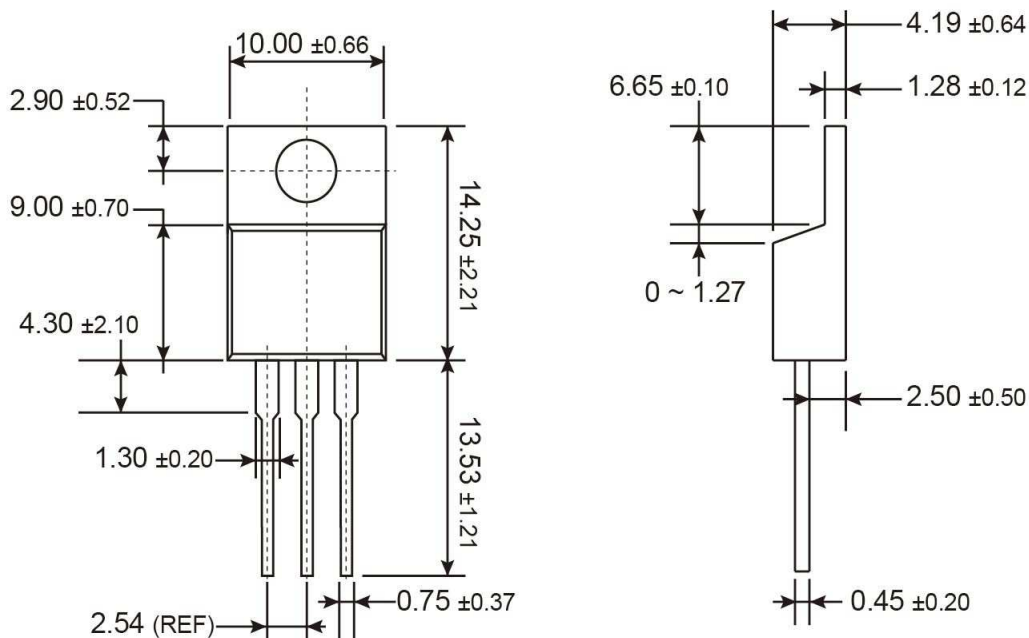

Unit: Millimeters

**Marking Diagram**

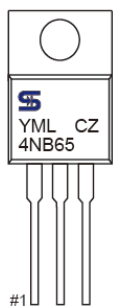

- Y** = Year Code
- M** = Month Code for Halogen Free Product
  - O** =Jan    **P** =Feb    **Q** =Mar    **R** =Apr
  - S** =May    **T** =Jun    **U** =Jul    **V** =Aug
  - W** =Sep    **X** =Oct    **Y** =Nov    **Z** =Dec
- L** = Lot Code



### ITO-220 Mechanical Drawing

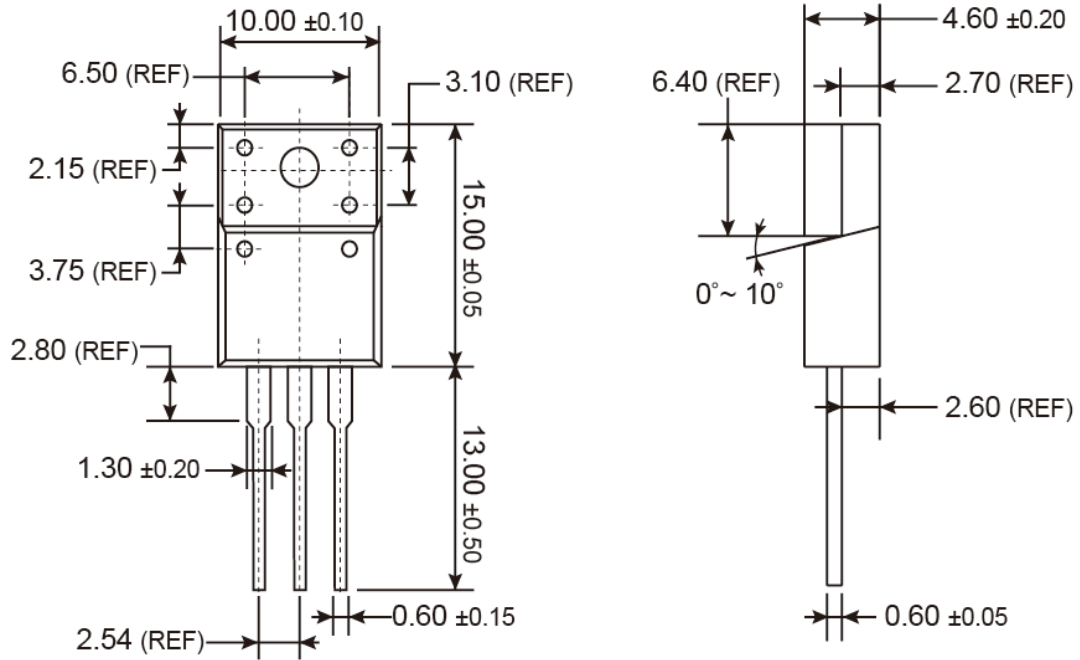

Unit: Millimeters

### Marking Diagram



- G** = Halogen Free
- Y** = Year Code
- WW** = Week Code (01~52)
- F** = Factory Code



### TO-252 (DPAK) Mechanical Drawing

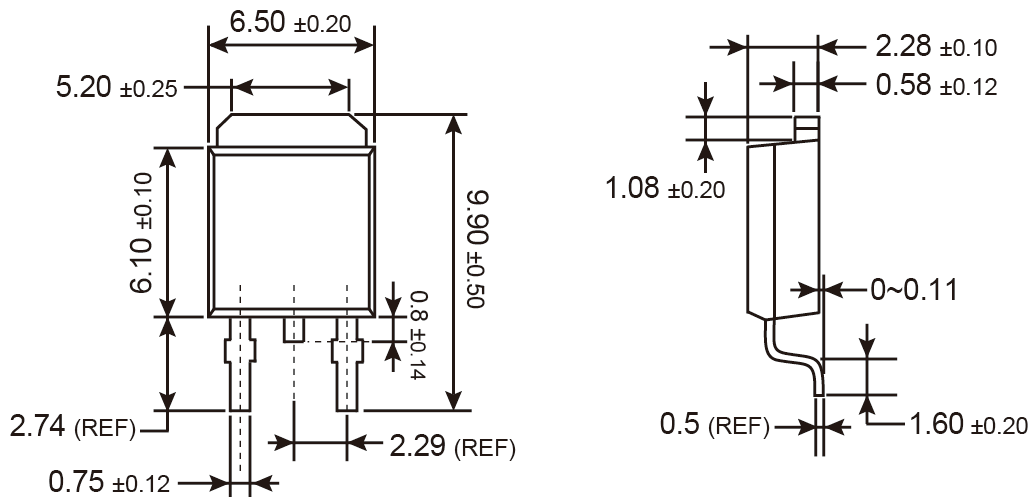

Unit: Millimeters

### Marking Diagram

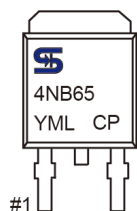

- Y = Year Code
- M = Month Code for Halogen Free Product
  - O =Jan
  - P =Feb
  - Q =Mar
  - R =Apr
  - S =May
  - T =Jun
  - U =Jul
  - V =Aug
  - W =Sep
  - X =Oct
  - Y =Nov
  - Z =Dec
- L = Lot Code





**TO-251 (IPAK) Mechanical Drawing**

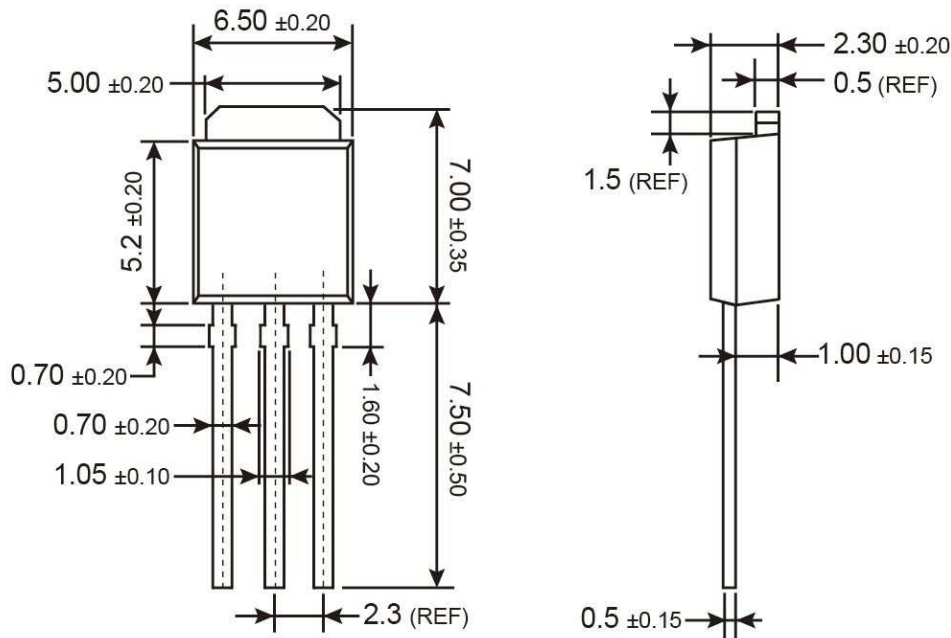

Unit: Millimeters

**Marking Diagram**

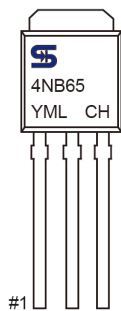

- Y = Year Code
- M = Month Code for Halogen Free Product
  - O =Jan    P =Feb    Q =Mar    R =Apr
  - S =May    T =Jun    U =Jul    V =Aug
  - W =Sep    X =Oct    Y =Nov    Z =Dec
- L = Lot Code

### Notice

Specifications of the products displayed herein are subject to change without notice. TSC or anyone on its behalf, assumes no responsibility or liability for any errors or inaccuracies.

Information contained herein is intended to provide a product description only. No license, express or implied, to any intellectual property rights is granted by this document. Except as provided in TSC's terms and conditions of sale for such products, TSC assumes no liability whatsoever, and disclaims any express or implied warranty, relating to sale and/or use of TSC products including liability or warranties relating to fitness for a particular purpose, merchantability, or infringement of any patent, copyright, or other intellectual property right.

The products shown herein are not designed for use in medical, life-saving, or life-sustaining applications. Customers using or selling these products for use in such applications do so at their own risk and agree to fully indemnify TSC for any damages resulting from such improper use or sale.



Компания «ЭлектроПласт» предлагает заключение долгосрочных отношений при поставках импортных электронных компонентов на взаимовыгодных условиях!

Наши преимущества:

- Оперативные поставки широкого спектра электронных компонентов отечественного и импортного производства напрямую от производителей и с крупнейших мировых складов;
- Поставка более 17-ти миллионов наименований электронных компонентов;
- Поставка сложных, дефицитных, либо снятых с производства позиций;
- Оперативные сроки поставки под заказ (от 5 рабочих дней);
- Экспресс доставка в любую точку России;
- Техническая поддержка проекта, помощь в подборе аналогов, поставка прототипов;
- Система менеджмента качества сертифицирована по Международному стандарту ISO 9001;
- Лицензия ФСБ на осуществление работ с использованием сведений, составляющих государственную тайну;
- Поставка специализированных компонентов (Xilinx, Altera, Analog Devices, Intersil, Interpoint, Microsemi, Aeroflex, Peregrine, Syfer, Eurofarad, Texas Instrument, Miteq, Cobham, E2V, MA-COM, Hittite, Mini-Circuits, General Dynamics и др.);

Помимо этого, одним из направлений компании «ЭлектроПласт» является направление «Источники питания». Мы предлагаем Вам помощь Конструкторского отдела:

- Подбор оптимального решения, техническое обоснование при выборе компонента;
- Подбор аналогов;
- Консультации по применению компонента;
- Поставка образцов и прототипов;
- Техническая поддержка проекта;
- Защита от снятия компонента с производства.



#### Как с нами связаться

**Телефон:** 8 (812) 309 58 32 (многоканальный)

**Факс:** 8 (812) 320-02-42

**Электронная почта:** [org@eplast1.ru](mailto:org@eplast1.ru)

**Адрес:** 198099, г. Санкт-Петербург, ул. Калинина, дом 2, корпус 4, литера А.