

Intel® NUC Products

NUC8i5INH / NUC8i7INH

Technical Product Specification

Regulatory Models: NUC8IN

Oct 2019
version 004

The Intel NUC Products NUC8i5INH/NUC8i7INH may contain design defects or errors known as errata that may cause the product to deviate from published specifications. Current characterized errata are documented in the Intel NUC Products NUC8i5INH/NUC8i7INH Specification Update.

Revision History

Revision	Revision History	Date
001	First release of Intel NUC Products NUC8i5INH/NUC8i7INH Technical Product Specification	March 2019
002	First production release of the Intel NUC Products NUC8i5INH/NUC8i7INH Technical Product Specification	May 2019
003	Specification Clarification	June 2019
004	Specification Clarification	Oct 2019

Disclaimer

This product specification applies to only the standard Intel® NUC Boards, Kits and Mini PCs with BIOS identifier INWHL357.0028.

INFORMATION IN THIS DOCUMENT IS PROVIDED IN CONNECTION WITH INTEL® PRODUCTS. NO LICENSE, EXPRESS OR IMPLIED, BY ESTOPPEL OR OTHERWISE, TO ANY INTELLECTUAL PROPERTY RIGHTS IS GRANTED BY THIS DOCUMENT. EXCEPT AS PROVIDED IN INTEL'S TERMS AND CONDITIONS OF SALE FOR SUCH PRODUCTS, INTEL ASSUMES NO LIABILITY WHATSOEVER, AND INTEL DISCLAIMS ANY EXPRESS OR IMPLIED WARRANTY, RELATING TO SALE AND/OR USE OF INTEL PRODUCTS INCLUDING LIABILITY OR WARRANTIES RELATING TO FITNESS FOR A PARTICULAR PURPOSE, MERCHANTABILITY, OR INFRINGEMENT OF ANY PATENT, COPYRIGHT OR OTHER INTELLECTUAL PROPERTY RIGHT. UNLESS OTHERWISE AGREED IN WRITING BY INTEL, THE INTEL PRODUCTS ARE NOT DESIGNED NOR INTENDED FOR ANY APPLICATION IN WHICH THE FAILURE OF THE INTEL PRODUCT COULD CREATE A SITUATION WHERE PERSONAL INJURY OR DEATH MAY OCCUR.

All Intel® NUC Boards are evaluated as Information Technology Equipment (I.T.E.) for use in personal computers (PC) for installation in homes, offices, schools, computer rooms, and similar locations. The suitability of this product for other PC or embedded non-PC applications or other environments, such as medical, industrial, alarm systems, test equipment, etc. may not be supported without further evaluation by Intel.

Intel Corporation may have patents or pending patent applications, trademarks, copyrights, or other intellectual property rights that relate to the presented subject matter. The furnishing of documents and other materials and information does not provide any license, express or implied, by estoppel or otherwise, to any such patents, trademarks, copyrights, or other intellectual property rights.

Intel may make changes to specifications and product descriptions at any time, without notice.

Designers must not rely on the absence or characteristics of any features or instructions marked "reserved" or "undefined." Intel reserves these for future definition and shall have no responsibility whatsoever for conflicts or incompatibilities arising from future changes to them.

Intel processor numbers are not a measure of performance. Processor numbers differentiate features within each processor family, not across different processor families: Go to: [Learn About Intel® Processor Numbers](#)

Intel NUC Boards and kits may contain design defects or errors known as errata, which may cause the product to deviate from published specifications. Current characterized errata are available on request.

Contact your local Intel sales office or your distributor to obtain the latest specifications before placing your product order.

Intel, Pentium and Celeron are trademarks of Intel Corporation in the U.S. and/or other countries.

* Other names and brands may be claimed as the property of others.

Copyright © 2019 Intel Corporation. All rights reserved.

Note: For this Technical Products Specification, the use of Intel NUC Products NUC8i5INH/NUC8i7INH

Board Identification Information

Basic Intel® NUC Board Identification Information

Intel NUC Board	AA Revision	BIOS Revision	Notes
NUC8i5INB	K29935-300	INWHL357.0028 or newer	1, 2
NUC8i7iNB	K29936-402	INWHL357.0028 or newer	1, 2

Notes:

- 1 The AA number is found on a small label on the Front USB connectors.
- 2 Intel® Core™ i5-8265U/ i7-8565U processor are used on this AA revision consists of the following component:
- 3

Device	Stepping	S-Spec Number(s)
Intel Core i5-8265U	W0	SREJR
	W0	SREJQ
	V0	SRFFX
Intel Core i7-8565U	W0	SREJP
	V0	SRFFW

Product Identification Information

Intel® NUC Products NUC8i5INH/NUC8i7INH {x}† Identification Information

Product Name	Intel® NUC Board	Differentiating Features
NUC8i5INHx	NUC8i5INB	8GB LPDDR3-2133 solder-down Memory with power adapter
NUC8i5INHJA		HDD kit with power adapter, 16GB Intel® Optane™ Module, 1TB HDD, 8GB LPDDR3-2133 solder-down Memory, Microsoft Windows 10 Home, "Intel® NUC 8 Home, a Mini PC with Windows 10"
NUC8i5INHPA		SSD kit with power adapter, 256 M.2 SSD, 8GB LPDDR3-2133 solder-down Memory, Microsoft Windows 10 Home, "Intel® NUC 8 Home, a Mini PC with Windows 10"
NUC8i5INHP	NUC8i5INB	SSD kit with power adapter, 256GB M.2 SSD, 8GB LPDDR3-2133 solder-down Memory
NUC8i7INHx	NUC8i7iNB	8GB LPDDR3-2133 solder-down Memory with power adapter
NUC8i7INHJA		HDD kit with power adapter, 16GB Intel® Optane™ Module, 1TB HDD, 8GB LPDDR3-2133 solder-down Memory, Microsoft Windows 10 Home, "Intel® NUC 8 Home, a Mini PC with Windows 10"
NUC8i7INHZ		HDD and SSD kit with power adapter, 1TB HDD and 256GB M.2 SSD, 8GB LPDDR3-2133 solder-down Memory

NUC8i7INHPA		SSD kit with power adapter, 256GB M.2 SSD, 8GB LPDDR3-2133 solder-down Memory, Microsoft Windows 10 Home, "Intel® NUC 8 Home, a Mini PC with Windows 10"
NUC8i7INHP		SSD kit with power adapter, 256GB M.2 SSD, 8GB LPDDR3-2133 solder-down Memory

Specification Changes or Clarifications

The table below indicates the Specification Changes or Specification Clarifications that apply to the Intel NUC Products NUC8i5INH / NUC8i7INH.

Specification Changes or Clarifications

Date	Type of Change	Description of Changes or Clarifications
October 2019	Specification Clarification	Clarified Board vs System environmental specifications.

Errata

Current characterized errata, if any, are documented in a separate Specification Update. See <http://www.intel.com/content/www/us/en/nuc/overview.html> for the latest documentation.

Preface

This Technical Product Specification (TPS) specifies the layout, components, connectors, power and environmental requirements, and the BIOS for Intel® NUC Products NUC8i5INH/NUC8i7INH are with pre-installed Hard Drive Disk(HDD), Solid-state disk(SSD), Optane Memory, Soldered-down memory, and operating system.

Intended Audience

The TPS is intended to provide detailed technical information about Intel NUC Products NUC8i5INH/NUC8i7INH and their components to the vendors, system integrators, and other engineers and technicians who need this level of information. It is specifically *not* intended for general audiences.

What This Document Contains

Chapter	Description
1	A description of the hardware used in Intel NUC Product NUC8i5INH/NUC8i7INH
2	A map of the resources of the Intel NUC Board
3	The features supported by the BIOS Setup program
4	A description of the front panel blink codes and BIOS error messages
5	The features of the Intel NUC Kits and Mini PCs

Typographical Conventions

This section contains information about the conventions used in this specification. Not all of these symbols and abbreviations appear in all specifications of this type.

Notes, Cautions, and Warnings



NOTE

Notes call attention to important information.



CAUTION

Cautions are included to help you avoid damaging hardware or losing data.

Other Common Notation

#	Used after a signal name to identify an active-low signal (such as USBP0#)
bpp	Bits per pixel
GB	Gigabyte (1,073,741,824 bytes)
GBps	Gigabytes per second
Gbps	Gigabits per second
KB	Kilobyte (1024 bytes)
Kb	Kilobit (1024 bits)
kbps	1000 bits per second
MB	Megabyte (1,048,576 bytes)
MBps	Megabytes per second
Mb	Megabit (1,048,576 bits)
Mbps	Megabits per second
TDP	Thermal Design Power
xxh	An address or data value ending with a lowercase h indicates a hexadecimal value.
x.x V	Volts. Voltages are DC unless otherwise specified.
*	This symbol is used to indicate third-party brands and names that are the property of their respective owners.

Contents

Revision History	iii
Note: For this Technical Products Specification, the use of Intel NUC Products NUC8i5INH/NUC8i7INH.....	iv
Board Identification Information.....	iv
Product Identification Information.....	iv
Errata.....	v
Preface	vi
Intended Audience.....	vi
What This Document Contains	vi
Typographical Conventions	vi
Contents	ix
1 Product Description	13
1.1 Overview	13
1.1.1 Feature Summary	13
1.1.2 Board Layout (Top)	15
1.1.3 Board Layout (Bottom).....	16
1.1.4 Block Diagram	18
1.2 Online Support.....	19
1.3 Processor	19
1.4 Graphics Capabilities	20
1.4.1 AMD Radeon™ 540X Graphics	20
1.4.2 High Definition Multimedia Interface* (HDMI*)	20
1.4.3 Mini DisplayPort* (mDP*).....	20
1.5 USB.....	22
1.6 SATA Interface.....	22
1.6.1 AHCI Mode.....	22
1.7 Real-Time Clock Subsystem.....	23
1.8 Audio Subsystem	24
1.9 LAN Subsystem.....	25
1.9.1 Intel® WGI219V Gigabit Ethernet Controller.....	25
1.9.2 LAN Subsystem Software.....	25
1.9.3 RJ-45 LAN Connector with Integrated LEDs.....	26
1.9.4 Wireless Network Module	26
1.10 Hardware Management Subsystem	27
1.10.1 Hardware Monitoring	27
1.10.2 Fan Monitoring.....	27
1.10.3 Thermal Solution	28

1.11	Power Management	29
1.11.1	ACPI	29
1.11.2	Hardware Support	31
1.11.3	HDMI Consumer Electronics Control (CEC)	33
1.12	Intel Platform Security Technologies	35
1.12.1	Intel® Virtualization Technology	35
1.12.2	Intel® Platform Trust Technology	35
2	Technical Reference	37
2.1	Memory Resources	37
2.1.1	Addressable Memory	37
2.2	Connectors and Headers	37
2.2.1	Front Panel Connectors	38
2.2.2	Back Panel Connectors	38
2.2.3	Headers and Connectors (Top)	39
2.2.4	Connectors and Headers (Bottom)	40
2.3	BIOS Security Jumper	44
2.4	Mechanical Considerations	46
2.4.1	Form Factor	46
2.4.2	Weight	47
2.5	Electrical Considerations	47
2.5.1	Power Supply Considerations	47
2.5.2	Fan Header Current Capability	47
2.6	Thermal Considerations	48
2.7	Reliability	51
2.8	Environmental	51
3	Overview of BIOS Features	53
3.1	Introduction	53
3.2	BIOS Flash Memory Organization	53
3.3	System Management BIOS (SMBIOS)	53
3.4	Legacy USB Support	54
3.5	BIOS Updates	54
3.5.1	Language Support	55
3.6	BIOS Recovery	55
3.7	Boot Options	55
3.7.1	Network Boot	55
3.7.2	Booting Without Attached Devices	56
3.7.3	Changing the Default Boot Device During POST	56
3.7.4	Power Button Menu	57
3.8	Hard Disk Drive Password Security Feature	58
3.9	BIOS Security Features	58
4	Error Messages and Blink Codes	60
4.1	Front-panel Power LED Blink Codes	60

5 Intel NUC Kit Features	61
5.1 Chassis Front Panel Features	61
5.2 Chassis Rear Panel Features.....	62

Figures

Figure 1. Major Board Components (Top)	15
Figure 2. Major Board Components (Bottom)	16
Figure 3. Block Diagram.....	18
Figure 4. 4-Pin 3.5 mm (1/8 inch) Audio Jack Pin Out	24
Figure 5. LAN Connector LED Locations.....	26
Figure 6. Thermal Solution and Fan Header.....	28
Figure 7. Location of the Standby Power LED	33
Figure 8. CEC Connector	34
Figure 9. Front Panel Connectors, Controls and Indicators	38
Figure 10. Back Panel Connectors	38
Figure 11. Headers and Connectors (Top).....	39
Figure 12. Connectors and Headers (Bottom)	40
Figure 13. Connection Diagram for Front Panel Header (2.0 mm Pitch)	Error! Bookmark not defined.
Figure 14. Location of the CIR Sensor	43
Figure 15. Location of the BIOS Security Jumper	44
Figure 16. Board Dimensions.....	46
Figure 17. Board Height Dimensions	47
Figure 18. Localized High Temperature Zones	49
Figure 19. Intel® NUC Products NUC8i5INH/NUC8i7INH Features – Front	61
Figure 20. Intel® NUC Products NUC8i5INH/NUC8i7INH Features – Rear	62

Tables

Table 1. Feature Summary	13
Table 2. Components Shown in Figure 1	15
Table 3. Components Shown in Figure 2	17
Table 4. LAN Connector LED States.....	26
Table 5. Effects of Pressing the Power Switch.....	29
Table 6. Power States and Targeted System Power	30
Table 7. Wake-up Devices and Events.....	31
Table 8. HDMI 1 CEC expected behavior.....	33
Table 9. Headers and Connectors Shown in Figure 11	39
Table 10. Connectors and Headers Shown in Figure 12	41
Table 11. SATA Power Header (0.5 mm Pitch)	41
Table 12. Single-Port Internal USB 2.0 Headers (1.25 mm Pitch).....	42
Table 13. Consumer Electronics Control (CEC) Connector (1.25 mm Pitch)	42
Table 14. SDXC Card Reader Connector	42
Table 15. BIOS Security Jumper Settings.....	45

Table 16. Select Weights and	47
Table 17. Select Chassis Dimensions	47
Table 18. Fan Header Current Capability.....	47
Table 19. Thermal Considerations for Components.....	50
Table 20. Tcontrol Values for Components	50
Table 21. Environmental Specifications.....	51
Table 22. Acceptable Drives/Media Types for BIOS Recovery	55
Table 23. Boot Device Menu Options.....	56
Table 24. Master Key and User Hard Drive Password Functions.....	58
Table 25. Supervisor and User Password Functions.....	59
Table 26. Front-panel Power LED Blink Codes	60
Table 27. Components Shown in Figure 19	61
Table 28. Components Shown in Figure 20	62

1 Product Description

1.1 Overview

1.1.1 Feature Summary

Table 1 summarizes the major features of the product.

Table 1. Feature Summary

Board Form Factor	4.0 inches by 4.0 inches (101.60 millimeters by 101.60 millimeters)
Processor	<ul style="list-style-type: none">• Soldered-down 8th Generation Intel® Core™ i5 Quad-core Processors with 15W TDP, 1.60 GHz<ul style="list-style-type: none">— TDP-up 25W— 6 MB SmartCache, 3.90 GHz Max Turbo Frequency— Integrated memory controller— Integrated PCH• Soldered-down 8th Generation Intel® Core™ i7 Quad-core Processors with 15W TDP, 1.80 GHz<ul style="list-style-type: none">— TDP-up 25W— 8 MB SmartCache, 4.60 GHz Max Turbo Frequency— Integrated memory controller— Integrated PCH
Memory	<ul style="list-style-type: none">• Soldered-down LPDDR3 1866 MHz(4GB), LPDDR3 2133 MHz(8GB), Dual channel• Soldered-down 4 GB or 8 GB memory technology• Support for non-ECC memory• Support for 1.2 V low voltage JEDEC memory
Graphics	<ul style="list-style-type: none">• Discrete graphic support with AMD Radeon™ 540X:<ul style="list-style-type: none">— One full-sized High Definition Multimedia Interface (HDMI) and one Mini DisplayPort (mDP) interface of rear panel.— HDMI™ 4K Support, DisplayPort 1.4 HDR
Audio	<ul style="list-style-type: none">• ADM Integrated HD-Audio Controller (Azalia) and Codec via the HDMI and mDP interfaces supporting compressed 7.1 digital audio• Realtek ALC256 HD Audio via a stereo microphone/headphone 3.5 mm jack on the front panel and 3.5mm combination speaker
Expansion Capabilities	<ul style="list-style-type: none">• One M.2 connector supporting M.2 2280 (key type M) modules
Storage	<ul style="list-style-type: none">• One SATA 6.0 Gbps port (black)<ul style="list-style-type: none">— Supports one 2.5" SSD or HDD up to 9.5mm• 1TB Hard Drive Disk included.• One full-sized SDXC slot
BIOS	<ul style="list-style-type: none">• Intel® BIOS resident in the Serial Peripheral Interface (SPI) Flash device• Support for Advanced Configuration and Power Interface (ACPI), Plug and Play, and System Management BIOS (SMBIOS)

Continued

Table 1. Feature Summary **(continued)**

Peripheral Interfaces	<ul style="list-style-type: none"> • USB 3.1 gen2 ports: <ul style="list-style-type: none"> — One USB TypeA and USB TypeC ports are implemented with external front panel connectors. — Two USB TypeA ports are implemented with external back panel connectors (blue) • Consumer Infrared (CIR) • Consumer Electronics Control (CEC) header • Front panel header • USB 2.0 ports: <ul style="list-style-type: none"> — Two ports via an internal common IO header
LAN Support	Gigabit (10/100/1000 Mbps) LAN subsystem using the Intel WGI219V Gigabit Ethernet Controller
Hardware Monitor Subsystem	<p>Hardware monitoring subsystem, based on an ITE8991VG embedded controller, including:</p> <ul style="list-style-type: none"> • Voltage sense to detect out of range power supply voltages • Thermal sense to detect out of range thermal values • One processor fan header • Fan sense input used to monitor fan activity • Fan speed control
Wireless	<p>Soldered down Intel® Wireless-AC 9560D2WG module</p> <ul style="list-style-type: none"> • Intel wireless802.11ac R2, 2x2, Dual Band, Wi-Fi • Bluetooth® 5 • Maximum Transfer speed up to 1.73Gbps • • Next Generation Form Factor (NGFF) 12x16 soldered-down package

1.1.2 Board Layout (Top)

Figure 1 shows the location of the major components on the top-side of Intel NUC Boards NUC8INB

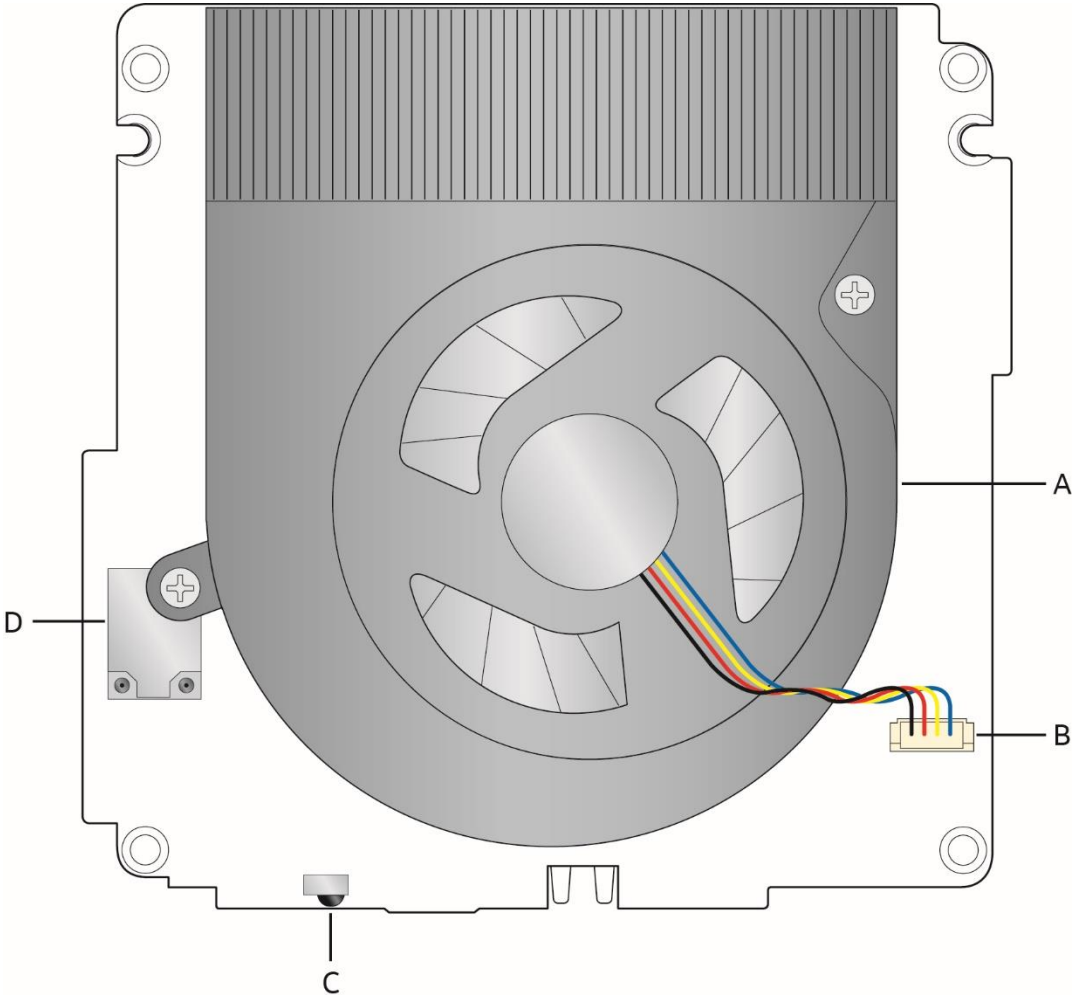

24411

Figure 1. Major Board Components (Top)

Table 2 lists the components identified in Figure 1.

Table 2. Components Shown in Figure 1

Item from Figure 1	Description
A	Thermal solution
B	Processor fan header
C	Consumer Infrared (CIR) sensor
D	Wireless LAN module

1.1.3 Board Layout (Bottom)

Figure 2 shows the location of the major components on the bottom-side of Intel NUC Mini PC NUC8i5INH/NUC8i7INH.

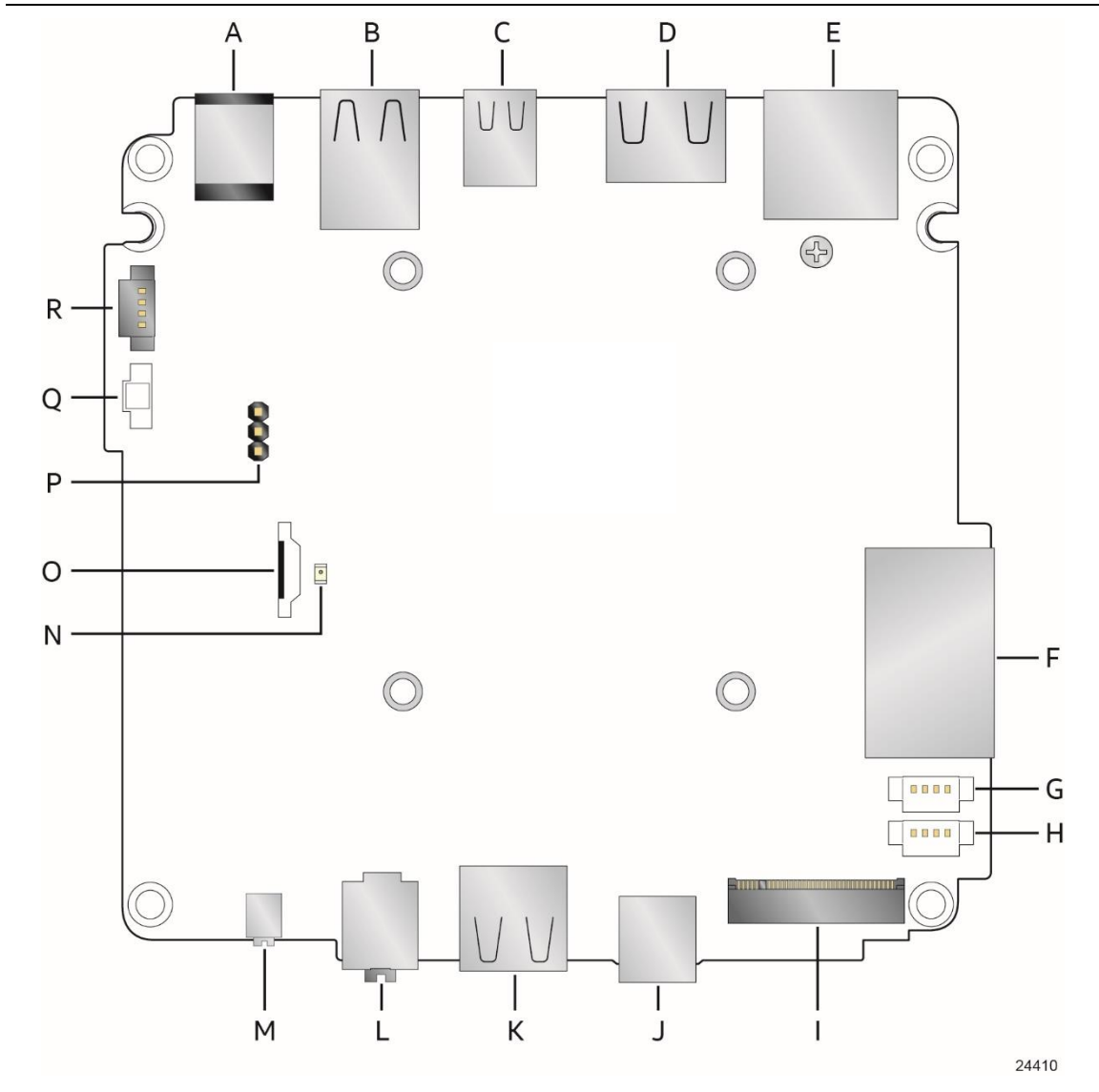

Figure 2. Major Board Components (Bottom)

Table 3. Components Shown in Figure 2

Item from Figure 2	Description
A	19V DC input jack
B	Back panel USB 3.1 gen2 connectors
C	Mini Display Port
D	HDMI connector
E	LAN jack
F	SDXC card reader slot
G	Front panel single-port USB 2.0 connector (1.25 mm pitch)
H	Front panel single-port USB 2.0 connector (1.25 mm pitch)
I	M.2 connector
J	Front panel USB 3.1 gen2 connector
K	Front panel USB 3.1 gen2 connector
L	Front panel stereo speaker/headphone/microphone jack
M	Power button / power LED
N	+5 V Standby Power Indicator LED
O	SATA 6.0 Gb/s connector
P	BIOS security jumper
Q	Battery (lithium coin cell, CR2032, 3.0V)
R	Consumer Electronic Control (CEC) connector

1.1.4 Block Diagram

Figure 3 is a block diagram of the major functional areas of the board.

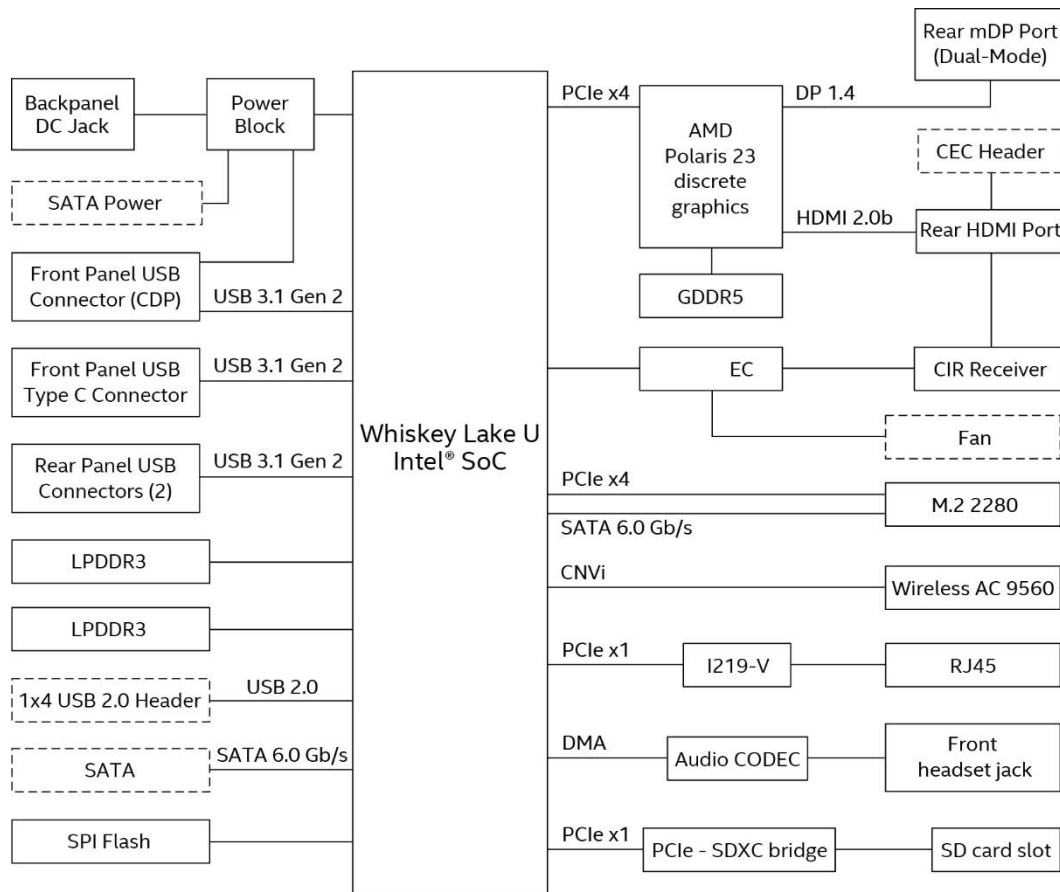

24414

Figure 3. Block Diagram

1.2 Online Support

To find information about...

Intel NUC Products NUC8i5INH/NUC8i7INH
NUC Board Support
Available configurations for Intel NUC Products
NUC8i5INH/NUC8i7INH
BIOS and driver updates
Integration information

Visit this World Wide Web site:

<http://www.intel.com/NUC>
<http://www.intel.com/NUCSupport>
<http://ark.intel.com>
<http://downloadcenter.intel.com>
<http://www.intel.com/NUCSupport>

1.3 Processor

Intel NUC Mini PC NUC8i5INH/NUC8i7INH has a soldered-down System-on-a-Chip (SoC), which consists of one of following:

Soldered-down 8th Generation Intel® Core™ i5 Quad-core Processors with 15W TDP, 1.60 GHz

- TDP-up 25W
- 6 MB SmartCache, 3.90 GHz Max Turbo Frequency
- Integrated memory controller
- Integrated PCH

Soldered-down 8th Generation Intel® Core™ i7 Quad-core Processors with 15W TDP, 1.80 GHz

- TDP-up 25W
- 8 MB SmartCache, 4.60 GHz Max Turbo Frequency
- Integrated memory controller
- Integrated memory



NOTE

The board has specific requirements for providing power to the processor. Refer to Section 2.5.1 on page 47 for information on power supply requirements for the board.

1.4 Graphics Capabilities

The kit supports graphics computing through AMD Radeon™ 540X

1.4.1 AMD Radeon™ 540X Graphics

The AMD Radeon graphics controller features the following:

- Supports HDR-10 video playback.
- Multi View Coding (MVC) support for Blu-ray 3D content.
- 3D graphics hardware acceleration supporting DirectX 12, OpenCL* 2.0, OpenGL 4.5
- Dedicated Unified Video Decoder hardware (UVD) for H.264, HEVC, VC-1, MPEG-4, MPEG-2, and MVC decode
- Non-HBR compressed audio pass-through up to 6.144 Mbps, support AC-3, MPEG1, MP3 (MPEG1 layer 3), MPEG2, AAC, DTS, ATRAC, Dolby Digital+, WMA Pro, and DTS-HD
- HBR compressed audio pass-through up to 24.576 Mbps, support DTS-HD Master Audio and Dolby True HD.
- Supports content protection using High-Bandwidth Digital Content Protection (HDCP) 2.2
- Support only GDDR5 DRAM.
- Supports AMD FreeSync™ technology

1.4.2 High Definition Multimedia Interface* (HDMI*)

The HDMI ports are compliant with the HDMI 2.0b specification. The HDMI ports support standard, enhanced, or high definition video, plus multi-channel digital audio on a single cable. The maximum supported resolution is 4096 x 2160 @ 60 Hz, 36bpp.

1.4.2.1 Integrated Audio Provided by the HDMI Interfaces

The following audio technologies are supported by the HDMI 2.0b interfaces directly from the SoC:

- AC3 - Dolby* Digital
- Dolby®-TrueHD Bitstream Capable

For information about

HDMI technology

Refer to

<http://www.hdmi.org>

1.4.3 Mini DisplayPort* (mDP*)

DisplayPort is a digital communication interface that utilizes differential signaling to achieve a high bandwidth bus interface designed to support connections between PCs and monitors, projectors, and TV displays. DisplayPort is suitable for display connections between consumer electronics devices such as high definition optical disc players, set top boxes, and TV displays. The maximum supported resolution is 7680 x 4320 @ 30Hz, 24bpp. DisplayPort via mini Display Port connector is compliant with the DisplayPort 1.4 specification.

DisplayPort output supports Multi-Stream Transport (MST) which allows for multiple independent video streams (daisy-chain connection with multiple monitors) over a single

DisplayPort. This will require the use of displays that support DisplayPort 1.4 and allow for this feature.

For information about

DisplayPort technology

Refer to

<http://www.displayport.org>

1.5 USB

The USB port arrangement is as follows:

- USB 3.1 gen2 ports:
 - Two ports are implemented with external front panel connectors (one USB Type C and one USB Type A with amber color charging capable)
 - Two ports are implemented with external back panel connectors (USB Type A with blue color)
 - Maximum current is 900 mA for each blue port, 1.5 A for the amber charging port
- USB 2.0 ports:
 - Two ports via two single-port internal 1x4 1.25 mm pitch headers (white)
 - Maximum current is 500 mA for each port of the white headers (1 A total)

All the USB ports are high-speed, full-speed, and low-speed capable.



NOTE

Computer systems that have an unshielded cable attached to a USB port may not meet FCC Class B requirements, even if no device is attached to the cable. Use a shielded cable that meets the requirements for full-speed devices.

For information about	Refer to
The location of the USB connectors on the back panel	Error! Reference source not found.
The location of the USB connector on the front panel	Figure 2

1.6 SATA Interface

The SoC provides one SATA port with a theoretical maximum transfer rate of 6.0 Gb/s. A point-to-point interface is used for host to device connections.

The underlying SATA functionality is transparent to the operating system. The SATA controller can operate in both legacy and native modes. In legacy mode, standard IDE I/O and IRQ resources are assigned (IRQ 14 and 15). In Native mode, standard PCI Conventional bus resource steering is used. Native mode is the preferred mode for configurations using Windows* operating systems.

1.6.1 AHCI Mode

The board supports AHCI storage mode.



NOTE

In order to use AHCI mode, AHCI must be enabled in the BIOS. Microsoft Windows* 10 includes the necessary AHCI drivers without the need to install separate AHCI drivers during the operating system installation process. However, it is always good practice to update the AHCI drivers to the latest available by Intel.*

1.7 Real-Time Clock Subsystem

A coin-cell lithium battery (CR2032) powers the real-time clock and CMOS memory. When the computer is not plugged into a wall socket, the battery has an estimated life of three years. When the computer is plugged in, the standby current from the power supply extends the life of the battery. The clock is accurate to ± 13 minutes/year at 25 °C with 3.3 VSB applied via the power supply 5 V STBY rail.



NOTE

If the battery and AC power fail, date and time values will be reset and the user will be notified during the POST.

When the voltage drops below a certain level, the BIOS Setup program settings stored in CMOS RAM (for example, the date and time) might not be accurate. Replace the battery with an equivalent one. Figure 1 shows the location of the battery.

1.8 Audio Subsystem

The product supports Intel HD Audio via the Realtek ALC233 audio codec. The audio subsystem supports the following features:

- Analog line-out/Analog Headphone/Analog Microphone jack on the front panel
- High Definition Audio via a stereo microphone/headphone/optical jack on the back panel
- Support for 44.1 kHz/48 kHz/96 kHz sample rates on all analog outputs
- Support for 44.1 kHz/48 kHz/96 kHz sample rates on all analog inputs
- Back Panel Audio Jack Support (see Figure 4 for 3.5 mm audio jack pin out):
 - Speakers only
 - Headphones only
 - Microphone only
 - Combo Headphone/Microphone
- Front Panel Audio Jack Support (see Figure 4 for 3.5 mm audio jack pin out):
 - Speakers only
 - Headphones only
 - Microphone only
 - Combo Headphone/Microphone

Figure 4. 4-Pin 3.5 mm (1/8 inch) Audio Jack Pin Out



Pin Number	Pin Name	Description
1	Tip	Left Audio Out
2	Ring	Right Audio Out
3	Ring	Common/Ground
4	Sleeve	Audio In



NOTE

The analog circuit of the back panel audio connector is designed to power headphones or amplified speakers only. Poor audio quality occurs if passive (nonamplified) speakers are connected to this output.

1.9 LAN Subsystem

The LAN subsystem consists of the following:

- Intel® WGI219V Gigabit Ethernet Controller (10/100/1000 Mb/s)
- RJ-45 LAN connector with integrated status LEDs
- Intel® Wireless-AC 9560D2WG module

Additional features of the LAN subsystem include:

- CSMA/CD protocol engine
- Jumbo frame support 9K
- LAN connect interface between the SoC and the LAN controller
- Power management capabilities
 - ACPI technology support
 - LAN wake capabilities
- LAN subsystem software

For information about

LAN software and drivers

Refer to

<http://downloadcenter.intel.com>

1.9.1 Intel® WGI219V Gigabit Ethernet Controller

Intel® WGI219V Gigabit Ethernet Controller supports the following features:

- 10/100/1000 BASE-T IEEE 802.3 compliant
- Energy Efficient Ethernet (EEE) IEEE802.3az support (Low Power Idle (LPI) mode)
- Dual interconnect between the Integrated LAN Controller and the Physical Layer (PHY):
 - PCI Express-based interface for active state operation (S0) state
 - SMBUS for host and management traffic (Sx low power state)
- Compliant to IEEE 802.3x flow control support
- 802.1p and 802.1q
- TCP, IP, and UDP checksum offload (for IPv4 and IPv6)
- Full device driver compatibility

For information about

Full LAN Hardware feature set

Refer to

<http://www.intel.com/Networking>

1.9.2 LAN Subsystem Software

LAN software and drivers are available from Intel's World Wide Web site.

For information about

Obtaining LAN software and drivers

Refer to

<http://downloadcenter.intel.com>

1.9.3 RJ-45 LAN Connector with Integrated LEDs

Two LEDs are built into the RJ-45 LAN connector (shown in Figure 5).

Figure 5. LAN Connector LED Locations

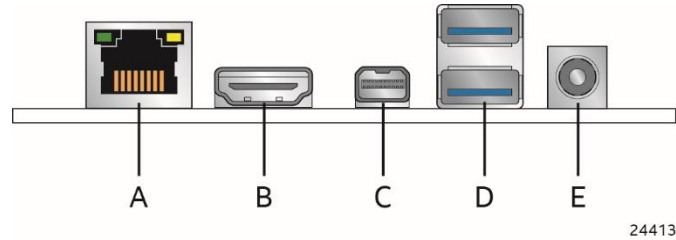

Item	Description
A	Link LED (Green)
B	Data Rate LED (Green/Yellow)

Table 4 describes the LED states when the board is powered up and the LAN subsystem is operating.

Table 4. LAN Connector LED States

LED	LED Color	LED State	Condition
Link (A)	Green	Off	LAN link is not established.
		On	LAN link is established.
		Blinking	LAN activity is occurring.
Data Rate (B)	Green/Yellow	Off	10 Mb/s data rate is selected.
		Green	100 Mb/s data rate is selected.
		Yellow	1000 Mb/s data rate is selected.

1.9.4 Wireless Network Module

The Intel Wireless-AC 9560D2W module provides high performance low power wireless connectivity with the following capabilities:

- 802.11ac R2, Dual Band, 2x2, Wi-Fi + Bluetooth 5.0
- Supports 2.4 Ghz and 5 Ghz bands
- Maximum transfer speed up to 1.73Gbps
- Supports Intel® Smart Connect Technology
- Supports Multiple-input and multiple-output (MIMO) technologies for wireless communications
- Soldered-down module

For information about

Refer to

Obtaining WLAN software and drivers

<http://downloadcenter.intel.com>

Full Specifications

<http://intel.com/wireless>

1.10 Hardware Management Subsystem

The hardware management features enable the board to be compatible with the Wired for Management (WfM) specification. The board has several hardware management features, including thermal and voltage monitoring.

For information about	Refer to
Wired for Management (WfM) Specification	www.intel.com/design/archives/wfm/

1.10.1 Hardware Monitoring

The hardware monitoring and fan control subsystem is based on an ITE IT8987VG embedded controller, which supports the following:

- Processor and system ambient temperature monitoring
- Chassis fan speed monitoring
- Voltage monitoring of DC Input Voltage, Memory Voltage Input, Processor Input Voltage, GPU Core Voltage.
- SMBus interface

1.10.2 Fan Monitoring

Fan monitoring can be implemented using third-party software.

1.10.3 Thermal Solution

Figure 6 shows the location of the thermal solution and processor fan header.

Figure 6. Thermal Solution and Fan Header

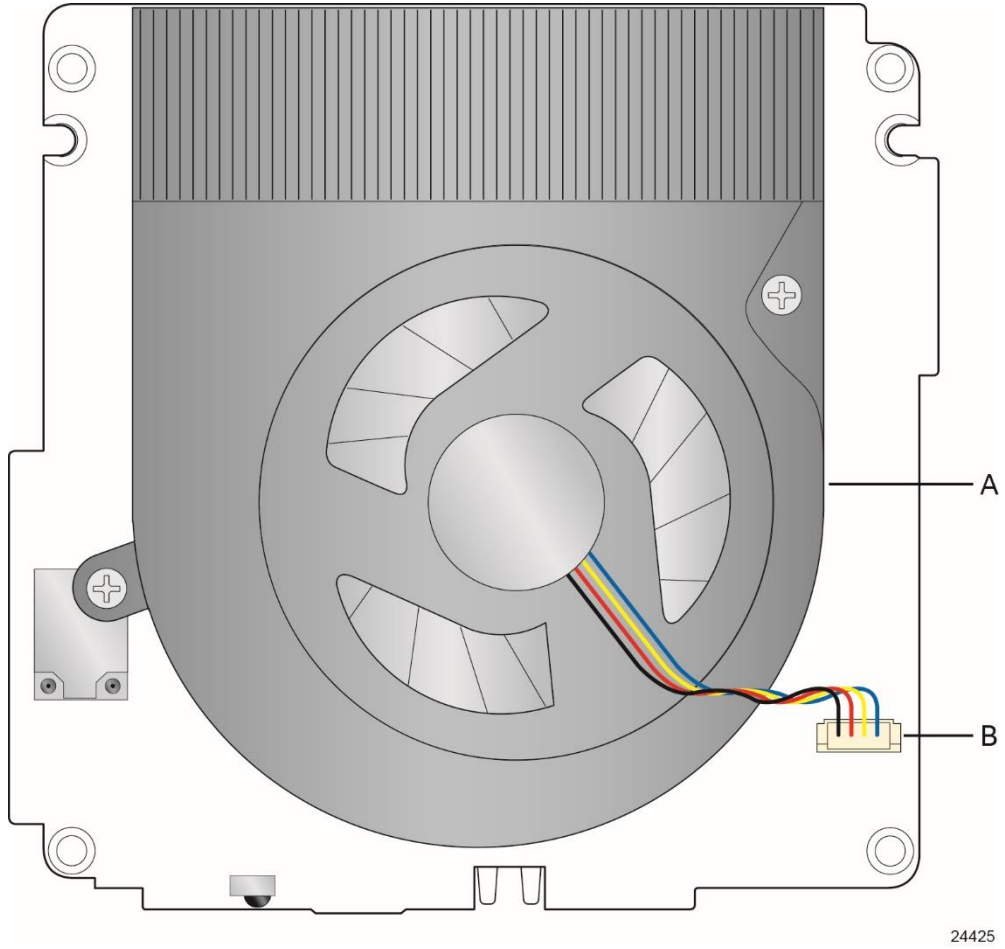

Item	Description
A	Thermal Solution
B	Processor fan header

1.11 Power Management

Power management is implemented at several levels, including:

- Software support through Advanced Configuration and Power Interface (ACPI)
- Hardware support:
 - Power Input
 - Instantly Available PC technology
 - LAN wake capabilities
 - Wake from USB
 - WAKE# signal wake-up support
 - Wake from S5
 - Wake from CIR
 - +5 V Standby Power Indicator LED

1.11.1 ACPI

ACPI gives the operating system direct control over the power management and Plug and Play functions of a computer. The use of ACPI with this board requires an operating system that provides full ACPI support. ACPI features include:

- Plug and Play (including bus and device enumeration)
- Power management control of individual devices, add-in boards (some add-in boards may require an ACPI-aware driver), video displays, and disk drives
- Methods for achieving less than 15-watt system operation in the power-on/standby sleeping state
- A Soft-off feature that enables the operating system to power-off the computer
- Support for multiple wake-up events (see Table 7 on page **Error! Bookmark not defined.**)
- Support for a front panel power and sleep mode switch

Table 5 lists the system states based on how long the power switch is pressed, depending on how ACPI is configured with an ACPI-aware operating system.

Table 5. Effects of Pressing the Power Switch

If the system is in this state...	...and the power switch is pressed for	...the system enters this state
Off (ACPI G2/G5 – Soft off)	Less than four seconds	Power-on (ACPI G0 – working state)
On (ACPI G0 – working state)	Less than four seconds	Soft-off/Standby (ACPI G1 – sleeping state) ^{Note}
On (ACPI G0 – working state)	More than six seconds	Fail safe power-off (ACPI G2/G5 – Soft off)
Sleep (ACPI G1 – sleeping state)	Less than four seconds	Wake-up (ACPI G0 – working state)
Sleep (ACPI G1 – sleeping state)	More than six seconds	Power-off (ACPI G2/G5 – Soft off)

Note: Depending on power management settings in the operating system.

1.11.1.1 System States and Power States

Under ACPI, the operating system directs all system and device power state transitions. The operating system puts devices in and out of low-power states based on user preferences and knowledge of how devices are being used by applications. Devices that are not being used can be turned off. The operating system uses information from applications and user settings to put the system as a whole into a low-power state.

Table 6 lists the power states supported by the board along with the associated system power targets. See the ACPI specification for a complete description of the various system and power states.

Table 6. Power States and Targeted System Power

Global States	Sleeping States	Processor States	Device States	Targeted System Power ^(Note 1)
G0 – working state	S0 – working	C0 – working	D0 – working state.	Full power
G1 – sleeping state	S3 – Suspend to RAM. Context saved to RAM.	No power	D3 – no power except for wake-up logic.	Power < 5 W ^(Note 2)
G1 – sleeping state	S4 – Suspend to disk. Context saved to disk.	No power	D3 – no power except for wake-up logic.	Power < 5 W ^(Note 2)
G2/S5	S5 – Soft off. Context not saved. Cold boot is required.	No power	D3 – no power except for wake-up logic.	Power < 5 W ^(Note 2)
G3 – mechanical off AC power is disconnected from the computer.	No power to the system.	No power	D3 – no power for wake-up logic, except when provided by battery or external source.	No power to the system. Service can be performed safely.

Notes:

1. Total system power is dependent on the system configuration, including add-in boards and peripherals powered by the system chassis' power supply.
2. Dependent on the standby power consumption of wake-up devices used in the system.

1.11.1.2 Wake-up Devices and Events

Table 7 lists the devices or specific events that can wake the computer from specific states.

Table 7. Wake-up Devices and Events

Devices/events that wake up the system...	...from this sleep state	Comments
Power switch	S3, S4, S5	
RTC alarm	S3, S4, S5 ¹	Monitor to remain in sleep state
LAN	S3, S4, S5 ^{1,3,4}	"S5 WOL after G3" must be supported; monitor to remain in sleep state
USB	S3, S4, S5 ^{2,3,4}	Wake S4, S5 controlled by BIOS option
PCIe via WAKE#	S3, S4, S5 ¹	Via WAKE; monitor to remain in sleep state
Consumer IR	S3, S4, S5 ^{2,4}	
Bluetooth	N/A	Wake from Bluetooth is not supported

Notes:

1. Monitor will remain in "sleep" state from S3 only
2. S4 implies operating system support only
3. Will not wake from Deep S4/S5. USB S4/S5 Power is controlled by BIOS. USB S5 wake is controlled by BIOS. USB S4 wake is controlled by OS driver, not just BIOS option.
4. Windows 10 Fast startup will block wake from LAN, USB, and CIR from S5



NOTE

The use of these wake-up events from an ACPI state requires an operating system that provides full ACPI support. In addition, software, drivers, and peripherals must fully support ACPI wake events.

1.11.2 Hardware Support

The board provides several power management hardware features, including:

- Wake from Power Button signal
- Instantly Available PC technology
- LAN wake capabilities
- Wake from USB
- WAKE# signal wake-up support
- Wake from S5
- Wake from CIR
- +5 V Standby Power Indicator LED



NOTE

The use of Wake from USB from an ACPI state requires an operating system that provides full ACPI support.

1.11.2.1 Power Input

When resuming from an AC power failure, the computer may return to the power state it was in before power was interrupted (on or off). The computer's response can be set using the Last Power State feature in the BIOS Setup program's Boot menu.

1.11.2.2 Instantly Available PC Technology

Instantly Available PC technology enables the board to enter the ACPI S3 (Suspend-to-RAM) sleep-state. While in the S3 sleep-state, the computer will appear to be off (the power supply is off, and the front panel LED is amber if dual colored, or off if single colored.) When signaled by a wake-up device or event, the system quickly returns to its last known wake state. Table 7 lists the devices and events that can wake the computer from the S3 state.

The use of Instantly Available PC technology requires operating system support and drivers for any installed PCI Express add-in card.

1.11.2.3 LAN Wake Capabilities

LAN wake capabilities enable remote wake-up of the computer through a network. The LAN subsystem monitors network traffic at the Media Independent Interface. Upon detecting a Magic Packet* frame, the LAN subsystem asserts a wake-up signal that powers up the computer.

1.11.2.4 Wake from USB

USB bus activity wakes the computer from an ACPI S3, S4, and S5 states.



NOTE

Wake from USB requires the use of a USB peripheral that supports Wake from USB.

1.11.2.5 WAKE# Signal Wake-up Support

When the WAKE# signal on the PCI Express bus is asserted, the computer wakes from an ACPI S3, S4, or S5 state.

1.11.2.6 Wake from S5

When the RTC Date and Time is set in the BIOS, the computer will automatically wake from an ACPI S5 state.

1.11.2.7 Wake from Consumer IR

CIR activity wakes the computer from an ACPI S3, S4, or S5 state.

1.11.2.8 +5 V Standby Power Indicator LED

The standby power indicator LED shows that power is still present even when the computer appears to be off. Figure 7 shows the location of the standby power LED.



CAUTION

If AC power has been switched off and the standby power indicator is still lit, disconnect the power cord before installing or removing any devices connected to the board. Failure to do so could damage the board and any attached devices.

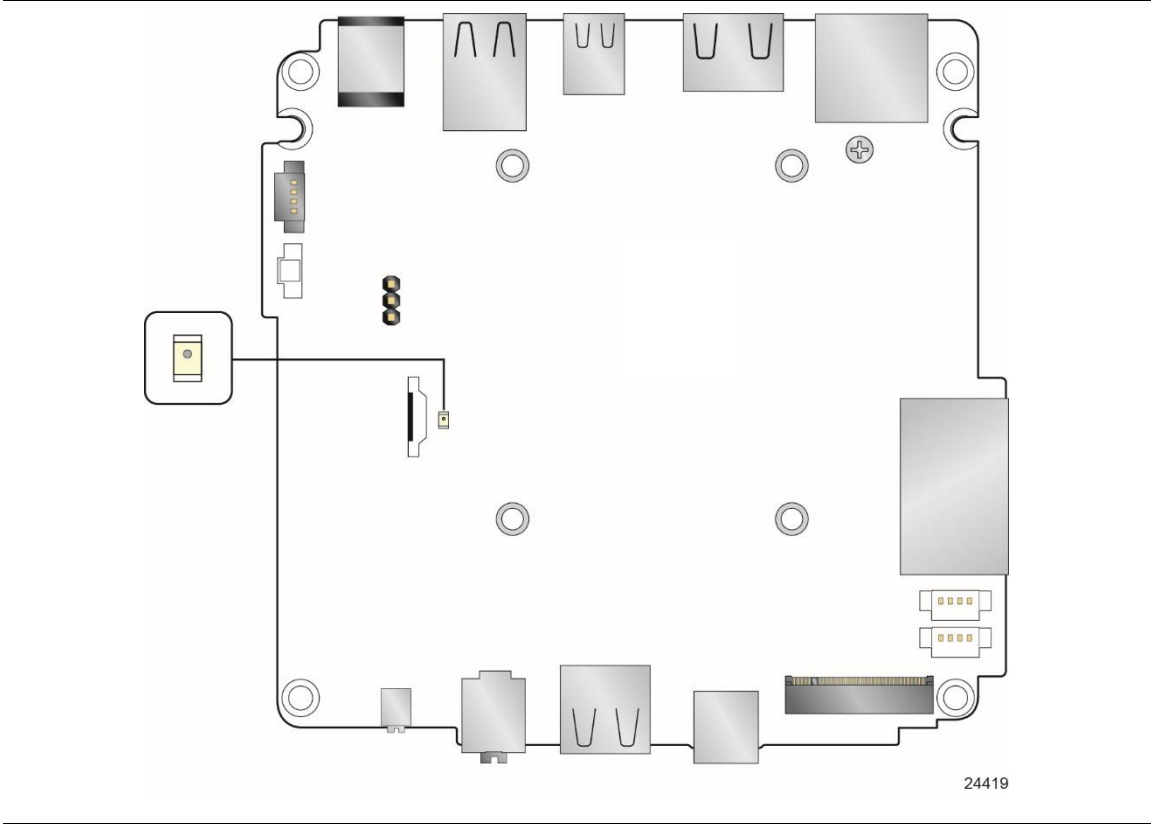

Figure 7. Location of the Standby Power LED

1.11.3 HDMI Consumer Electronics Control (CEC)

The board contains two mutually-exclusive methods for controlling HDMI CEC devices:

- External CEC adaptor connected via CEC connector (see Figure 8; pinout in Table 13).
- Onboard CEC control from the embedded controller via HDMI cable connected to HDMI 1 and BIOS setup. Expected behavior is provided in Table 8 below.

Table 8. HDMI 1 CEC expected behavior

Activity	Current Status		Action	Expected Behavior
	PC ^{1,2}	TV ³		
Wake On TV	Off	Off	TV on	PC on
Standby by TV	On	On	TV Standby	PC sleep or power off ⁴

Auto Turn Off TV (S0 -> S5)	On	On	PC Shutdown	TV standby ³
Auto Turn On TV (S5 -> S0)	Off	Off	PC On	TV on ³
Auto Turn Off TV (S0 -> S3)	On	On	PC Sleep	TV standby ³
Auto Turn On TV (S3 -> S0)	Off	Off	PC On	TV on ³

Notes:

1. *HDMI CEC Control* enabled in BIOS Setup and in TV setup, if necessary. Please consult your TV's documentation.
2. *Fast Boot* and *Deep S4/S5* disabled in BIOS Setup.
3. Results seen with Panasonic LED TV VIERA TH-40A400W. Other TVs may have different results due to variable implementations of CEC features.
4. PC power off behavior dependent upon power button setting in operating system.
5. If using external CEC adaptor, onboard CEC control must be disabled in BIOS Setup.

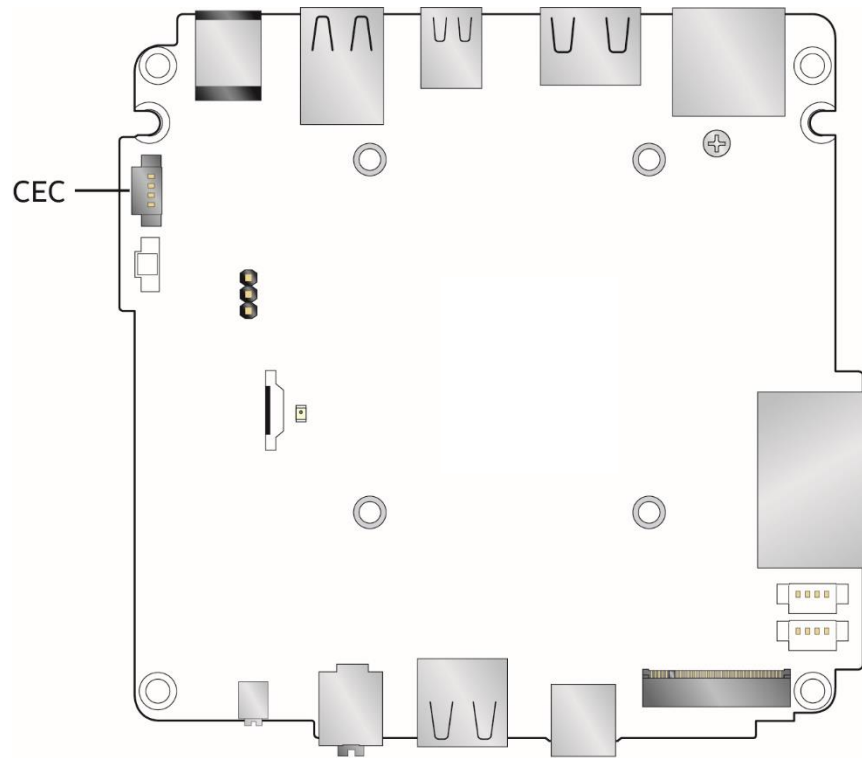

24423

Figure 8. CEC Connector

1.12 Intel Platform Security Technologies

Intel platform security technologies provides tools and resources to help the user protect their information by creating a safer computing environment.



NOTE

Software with security capability is required to take advantage of Intel platform security technologies.

1.12.1 Intel® Virtualization Technology

Intel Virtualization Technology (Intel® VT) is a hardware-assisted technology that, when combined with software-based virtualization solutions, provides maximum system utilization by consolidating multiple environments into a single server or client.



NOTE

A processor with Intel VT does not guarantee that virtualization will work on your system. Intel VT requires a computer system with a chipset, BIOS, enabling software and/or operating system, device drivers, and applications designed for this feature.

For information about

Intel Virtualization Technology

Refer to

<http://www.intel.com/technology/virtualization/technology.htm>

1.12.2 Intel® Platform Trust Technology

Intel® Platform Trust Technology (Intel® PTT) Generation 3 is a platform functionality for credential storage and key management. Intel® PTT supports Microsoft* BitLocker* Drive Encryption for hard drive encryption and supports all Microsoft requirements for firmware Trusted Platform Module (fTPM) 2.0.



NOTE

Support for fTPM version 2.0 requires a true UEFI-enabled operating system, such as Microsoft Windows* 10.*



CAUTION

BIOS recovery using the BIOS security jumper clears Intel® Platform Trust Technology (Intel® PTT) keys. These keys will not be restored after the BIOS recovery.

For information about

Intel Platform Trust Technology

Refer to

<http://www.intel.com/content/dam/www/public/us/en/documents/white-papers/enterprise-security-platform-trust-technology-white-paper.pdf>

2 Technical Reference

2.1 Memory Resources

2.1.1 Addressable Memory

The board utilizes up to 8 GB of addressable system memory. Typically the address space that is allocated for PCI Conventional bus add-in cards, PCI Express configuration space, BIOS (SPI Flash device), and chipset overhead resides above the top of DRAM (total system memory). On a system that has 8 GB of system memory installed, it is not possible to use all of the installed memory due to system address space being allocated for other system critical functions. These functions include the following:

- BIOS/SPI Flash device (64 Mbit)
- Local APIC (19 MB)
- Direct Media Interface (40 MB)
- PCI Express configuration space (256 MB)
- SoC base address registers PCI Express ports (up to 256 MB)
- Memory-mapped I/O (I/O fabric) that is dynamically allocated for PCI Express add-in cards (256 MB)

The board provides the capability to reclaim the physical memory overlapped by the memory mapped I/O logical address space. The board remaps physical memory from the top of usable DRAM boundary to the 4 GB boundary to an equivalent sized logical address range located just above the 4 GB boundary. All installed system memory can be used when there is no overlap of system addresses.

2.2 Connectors and Headers



CAUTION

Only the following connectors and headers have overcurrent protection: back panel and front panel USB.

The other internal connectors and headers are not overcurrent protected and should connect only to devices inside the computer's chassis, such as fans and internal peripherals. Do not use these connectors or headers to power devices external to the computer's chassis. A fault in the load presented by the external devices could cause damage to the computer, the power cable, and the external devices themselves.

Furthermore, improper connection of USB header single wire connectors may eventually overload the overcurrent protection and cause damage to the board.

- Front panel I/O connector
- Back panel I/O connectors

2.2.1 Front Panel Connectors

Figure 9 shows the location of the front panel connectors, controls and indicators for the board.

Figure 9. Front Panel Connectors, Controls and Indicators

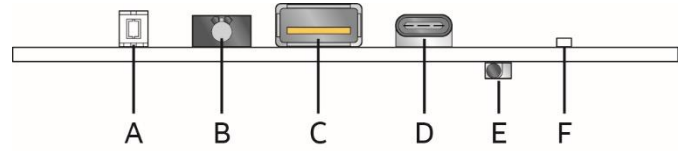

24412

Item	Description
A	Power switch and LED
B	Front panel stereo microphone/headphone jack
C	USB 3.1 Gen2 charging-capable port (amber)
D	USB 3.1 Gen 2 USB Type C
E	CIR
F	Hard drive activity LED

2.2.2 Back Panel Connectors

Figure 10 shows the location of the back panel connectors for the board.

Figure 10. Back Panel Connectors

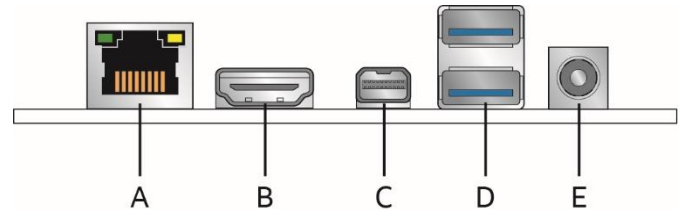

24413

Item	Description
A	RJ45 LAN connector
B	HDMI connector
C	Mini DP connector
D	USB 3.1 Gen2 ports
E	19V DC input jack

2.2.3 Headers and Connectors (Top)

Figure 11 shows the location of the headers and connectors on the top-side of the board.

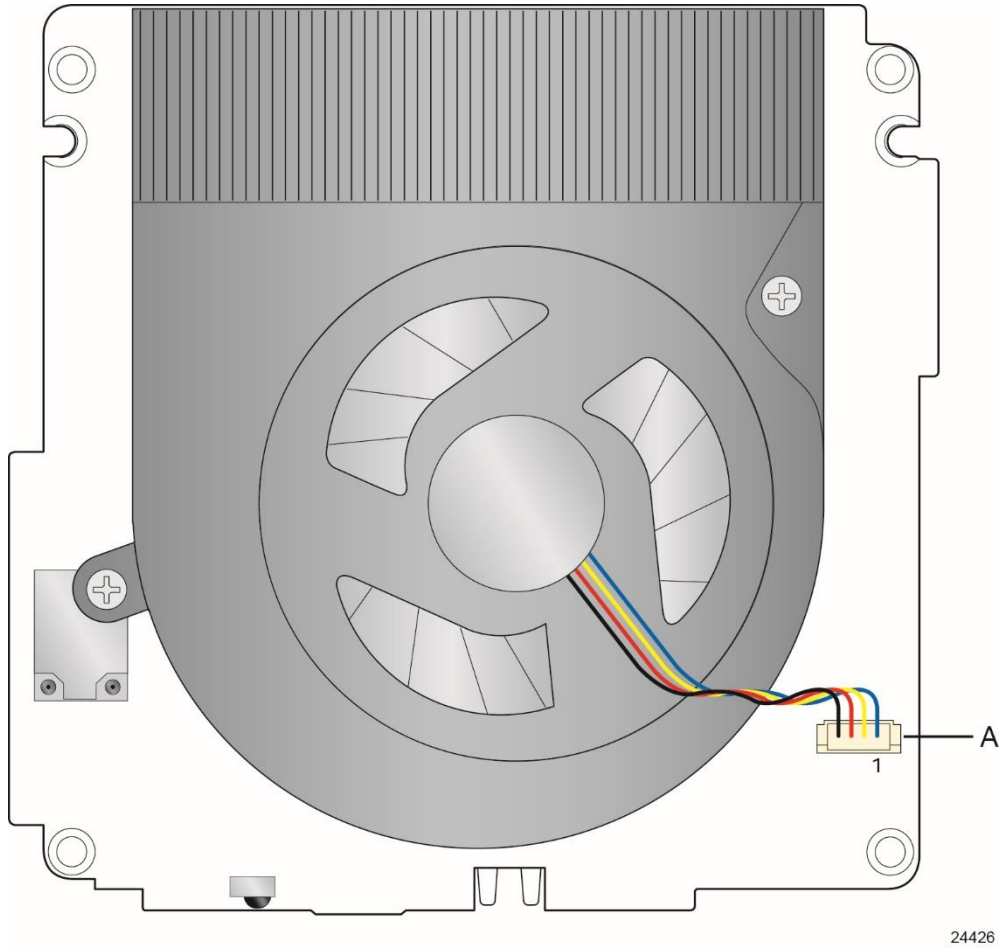

Figure 11. Headers and Connectors (Top)

Table 9 lists the headers and connectors identified in Figure 11.

Table 9. Headers and Connectors Shown in Figure 11

Item from Figure 11	Description
A	Processor fan header

2.2.4 Connectors and Headers (Bottom)

Figure 12 shows the locations of the connectors and headers on the bottom-side of the board.

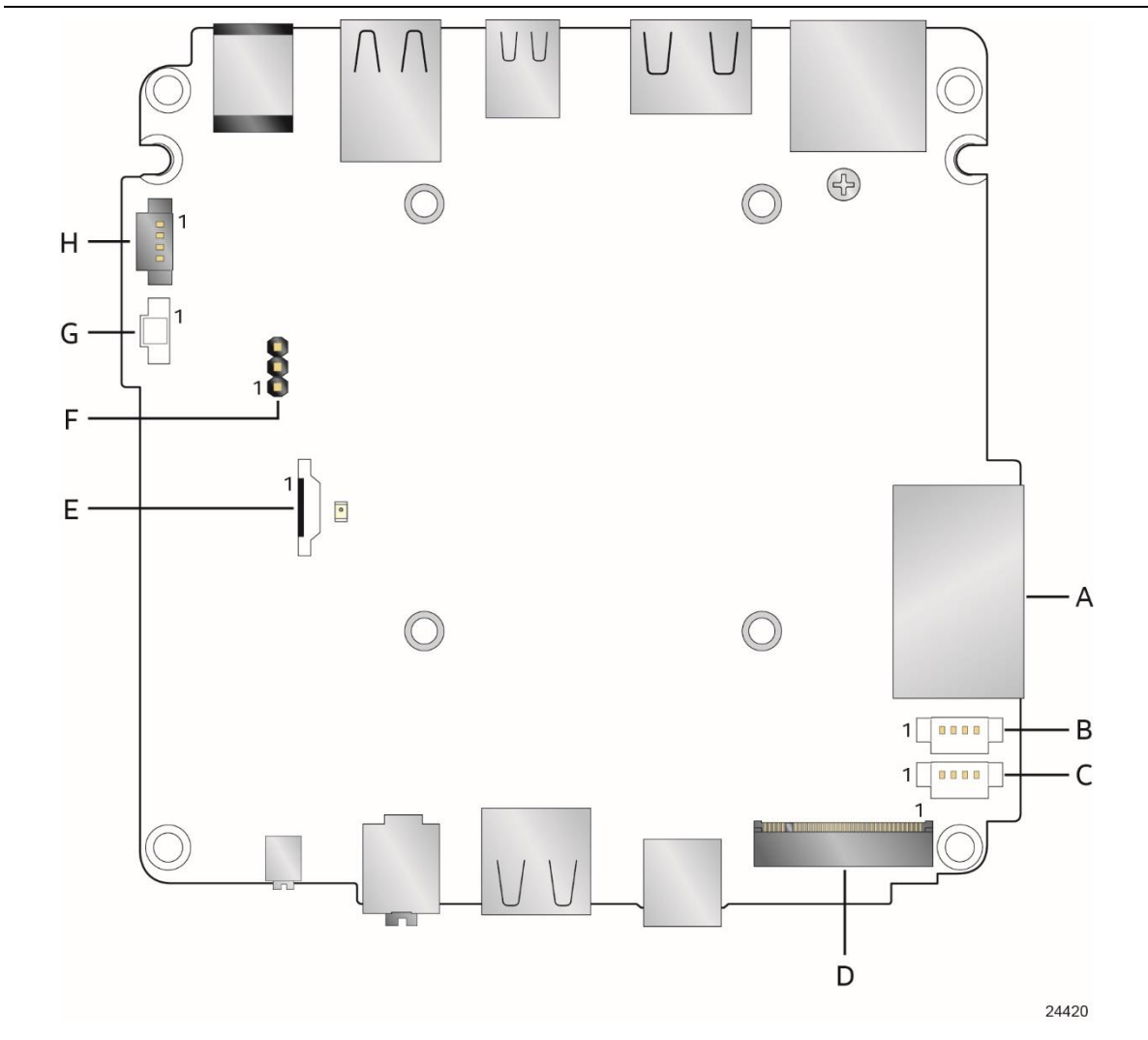

Figure 12. Connectors and Headers (Bottom)

Table 10 lists the connectors and headers identified in Figure 12.

Table 10. Connectors and Headers Shown in Figure 12

Item from Figure 12	Description
A	SDXC slot
B, C	Front panel single-port USB 2.0 header (USB1/USB2) (1.25 mm pitch)
D	M.2 connector
E	SATA 6.0 Gb/s connector
F	BIOS security jumper (BIOS_SEC)
G	RTC Battery connector
H	Consumer Electronics Control (CEC) connector (1.25 mm pitch)

Signal Tables for the Connectors and Headers

Table 11. SATA Power Header (0.5 mm Pitch)

Pin	Signal Name
1, 2, 3, 4	5 V
5	Null
6, 7	3.3 V
8	Null
9, 10	GND
11	Rx Data(Positive)
12	Rx Data(Negative)
13	GND
14	Tx Data(Negative)
15	Tx Data(Positive)
16, 17, 18, 19, 20	GND

Table 12. Single-Port Internal USB 2.0 Headers (1.25 mm Pitch)

Pin	Signal Name
1	GND
2	Data (positive)
3	Data (negative)
4	+5 V DC

**NOTE**

- Use only an internal USB connector that conforms to the USB 2.0 specification for high-speed USB devices.

Table 13. Consumer Electronics Control (CEC) Connector (1.25 mm Pitch)

Pin	Signal Name
1	+5VSB
2	Ground
3	CEC_PWR
4	HDMI_CEC

2.2.4.1 SDXC Card Reader

The board has a standard Secure Digital (SD) card reader that supports the Secure Digital eXtended Capacity (SDXC) format, 3.01 specification.

Table 14. SDXC Card Reader Connector

Pin	Signal Name	Descriptive Name
1	CD	Card Detection
2	DATA2	Serial Data 2
3	DATA3	Serial Data 3
4	CMD	Command
5	VSS1	Ground
6	VDD	Power (3.3 V)
7	CLK	Serial Clock
8	VSS2	Ground
9	DATA0	Serial Data 0
10	DATA1	Serial Data 1
11	WP	Write Protect

**NOTE**

The SD card reader is not supported in Microsoft Windows* 7*

2.2.4.2 Power Supply Connector

The board has the following power supply connector:

External Power Supply – the board is powered through a 19 V DC connector on the back panel.

The back panel DC connector is compatible with a 5.5 mm/OD (outer diameter) and 2.5 mm/ID (inner diameter) plug, where the inner contact is 19 (±10%) V DC and the shell is GND.

The maximum current rating is 4.74 A.

2.2.4.2.1 Power Sensing Circuit

The board has a power sensing circuit that:

- Manages CPU power usage to maintain system power consumption below 90 W.
- Designed for use with 90 W AC-DC adapters.

2.2.4.3 Consumer Infrared (CIR) Sensor

The Consumer Infrared (CIR) sensor on the front panel provides features that are designed to comply with Microsoft Consumer Infrared usage models.

The CIR feature is made up of the receiving sensor. The receiving sensor consists of a filtered translated infrared input compliant with Microsoft CIR specifications.

Customers are required to provide their own media center compatible remote or smart phone application for use with the Intel NUC. Figure 13 shows the location of the CIR sensor.

Figure 13. Location of the CIR Sensor

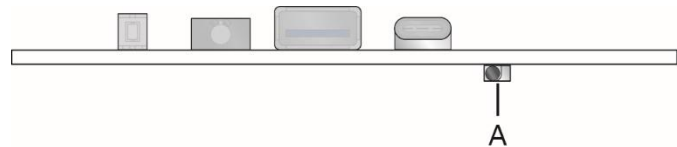

24418

Item	Description
A	CIR Sensor

2.3 BIOS Security Jumper



CAUTION

Do not move a jumper with the power on. Always turn off the power and unplug the power cord from the computer before changing a jumper setting. Otherwise, the board could be damaged.

Figure 14 shows the location of the BIOS security jumper. The 3-pin jumper determines the BIOS Security program's mode. Table 15 describes the BIOS security jumper settings for the three modes: normal, lockdown, and configuration.

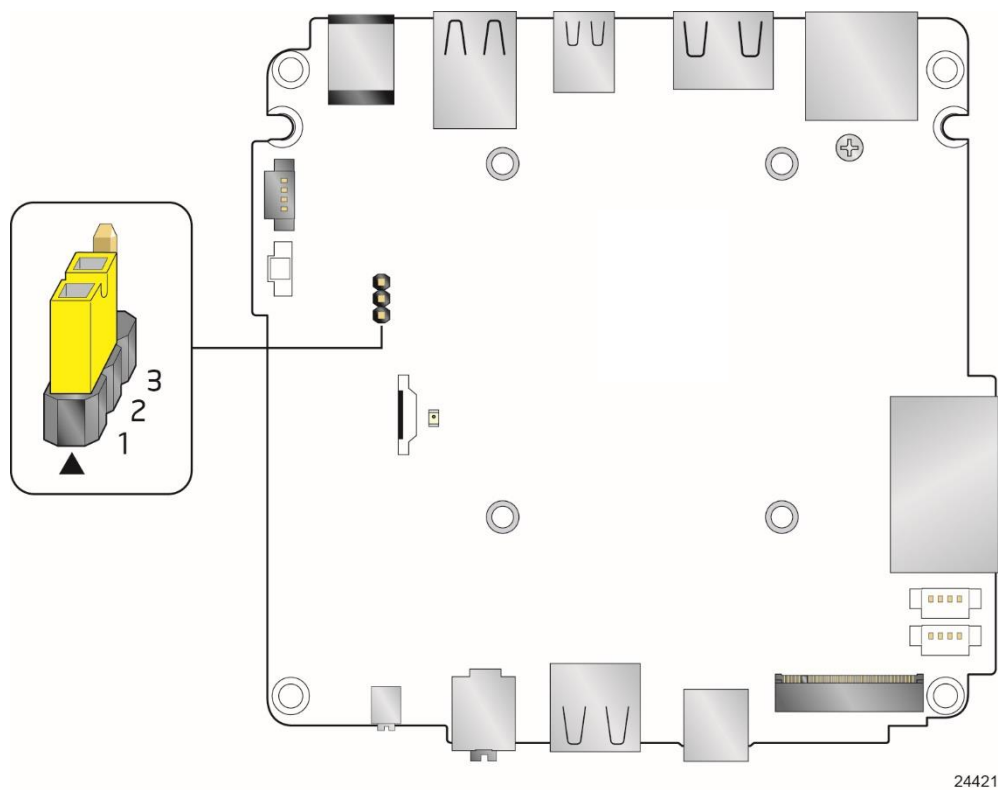

Figure 14. Location of the BIOS Security Jumper

Table 15. BIOS Security Jumper Settings

Function/Mode	Jumper Setting	Configuration
Normal	1-2	The BIOS uses current configuration information and passwords for booting.
Lockdown	2-3	<p>The BIOS uses current configuration information and passwords for booting, except:</p> <ul style="list-style-type: none"> • All POST Hotkeys are suppressed (prompts are not displayed and keys are not accepted. For example, F2 for Setup, F10 for the Boot Menu). • Power Button Menu is not available (see Section 3.7.4 Power Button Menu). <p>BIOS updates are not available except for automatic Recovery due to flash corruption.</p>
Configuration	None	<p>BIOS Recovery Update process if a matching *.bio file is found. Recovery Update can be cancelled by pressing the Esc key.</p> <p>If the Recovery Update was cancelled or a matching *.bio file was not found, a Config Menu will be displayed. The Config Menu consists of the following (followed by the Power Button Menu selections):</p> <p>[1] Suppress this menu until the BIOS Security Jumper is replaced.</p> <p>[2] Clear BIOS User and Supervisor Passwords.</p> <p>See Section 3.7.4 Power Button Menu.</p>

2.4 Mechanical Considerations

2.4.1 Form Factor

The board is designed to fit into a custom chassis. Figure 15 illustrates the mechanical form factor for the board. Dimensions are given in millimeters. The outer dimensions are 101.60 millimeters by 101.60 millimeters [4.0 inches by 4.0 inches].

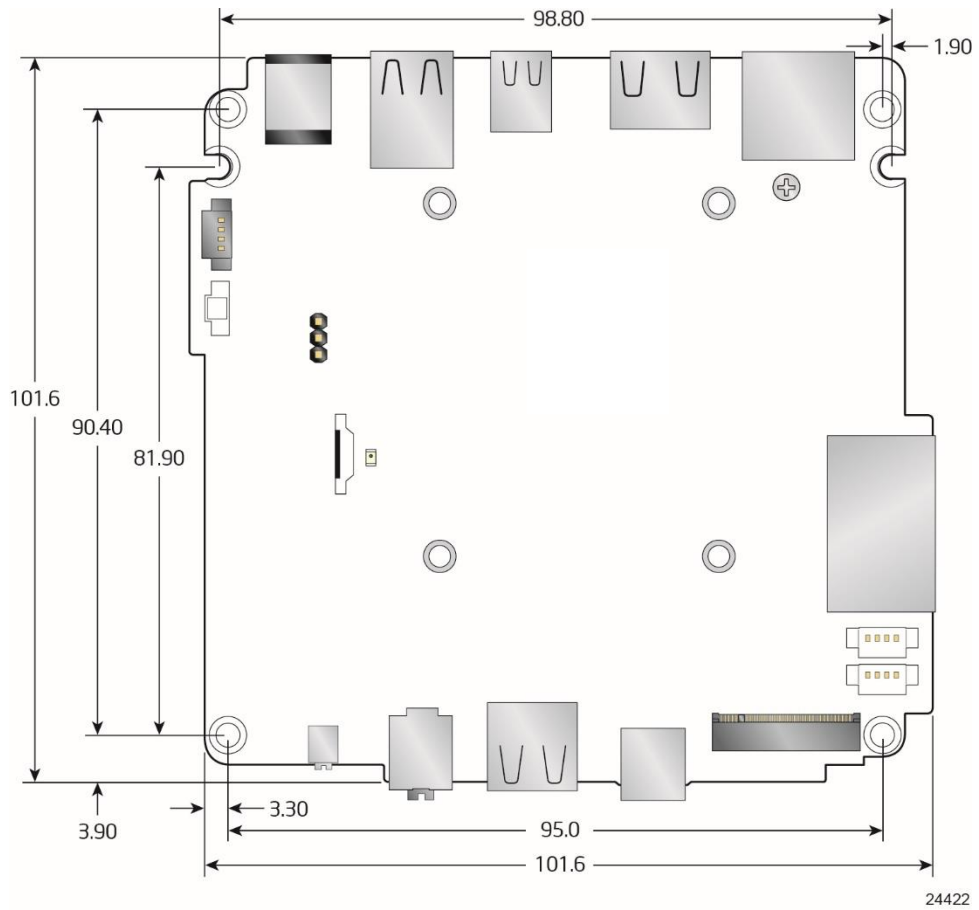

Figure 15. Board Dimensions

Figure 16 shows the height dimensions of the board.

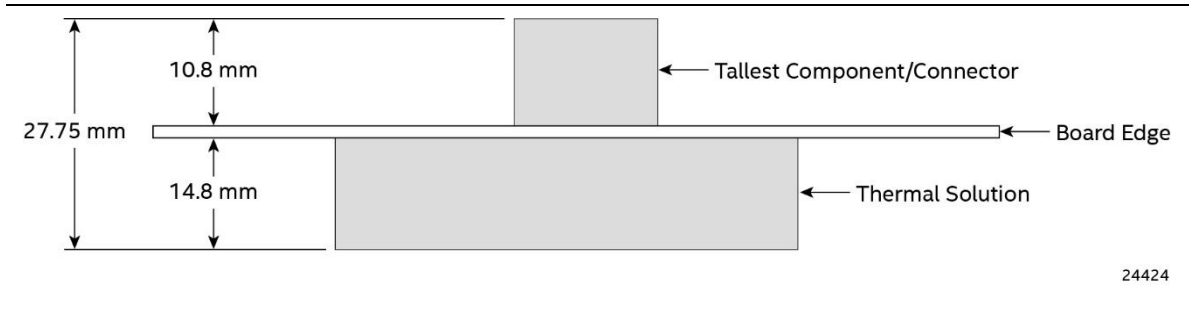

Figure 16. Board Height Dimensions

2.4.2 Weight

Error! Reference source not found. lists select weights of boards and kits and Table 17 lists kit dimensions.

Table 16. Select Weights and

Item	Weight (in kg)
Board with Thermal Solution	0.2
Mini PC (includes Board Assembly, memory, and drive)	0.66

Table 17. Select Chassis Dimensions

Item	Chassis Dimensions (WxDxH, in mm)
Tall Kit (includes chassis feet)	117 x 112 x 52

2.5 Electrical Considerations

2.5.1 Power Supply Considerations

System power requirements will depend on actual system configurations chosen by the integrator, as well as end user expansion preferences. It is the system integrator’s responsibility to ensure an appropriate power budget for the system configuration is properly assessed based on the system-level components chosen.

2.5.2 Fan Header Current Capability

Table 18 lists the current capability of the fan header.

Table 18. Fan Header Current Capability

Fan Header	Maximum Available Current
Processor fan	.25 A

2.6 Thermal Considerations



CAUTION

A chassis with a maximum internal ambient temperature of 55 °C at the processor fan inlet is recommended. If the internal ambient temperature exceeds 55 °C, further thermal testing is required to ensure components do not exceed their maximum case temperature.



CAUTION

Failure to ensure appropriate airflow may result in reduced performance of both the processor and/or voltage regulator or, in some instances, damage to the board.

All responsibility for determining the adequacy of any thermal or system design remains solely with the system integrator. Intel makes no warranties or representations that merely following the instructions presented in this document will result in a system with adequate thermal performance.



CAUTION

Ensure that the ambient temperature does not exceed the board's maximum operating temperature. Failure to do so could cause components to exceed their maximum case temperature and malfunction. For information about the maximum operating temperature, see the environmental specifications in Section 2.8.



CAUTION

Ensure that proper airflow is maintained in the processor voltage regulator circuit. Failure to do so may result in shorter than expected product lifetime. Figure 17 shows the locations of the localized high temperature zones. Figure 17 shows the locations of the localized high temperature zones.

Figure 17 shows the locations of the localized high temperature zones.

Figure 17. Localized High Temperature Zones

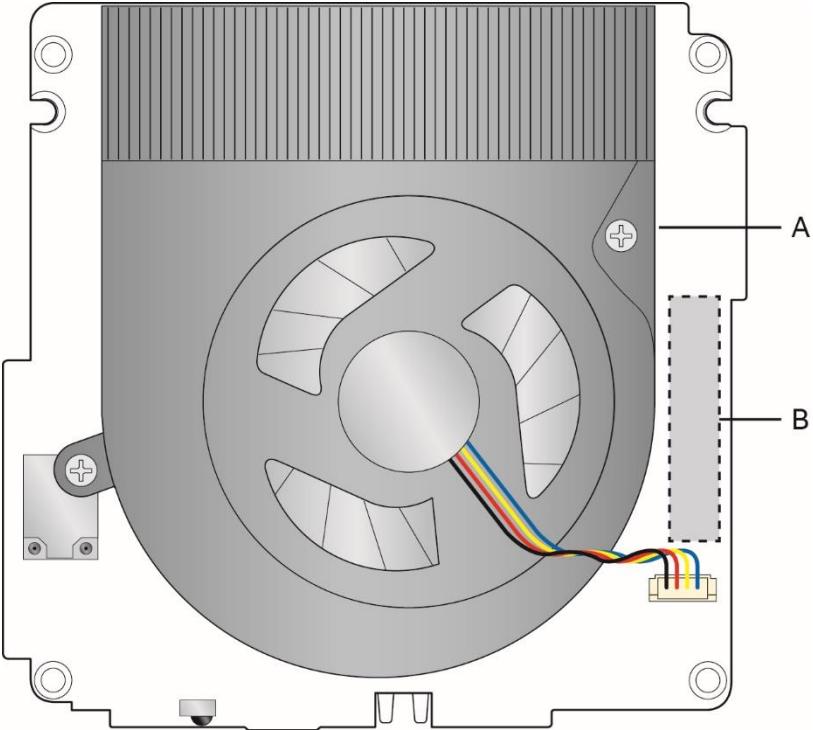

24427

Item	Description
A	Thermal solution
B	Processor voltage regulator area

Table 19 provides maximum case temperatures for the components that are sensitive to thermal changes. The operating temperature, current load, or operating frequency could affect case temperatures. Maximum case temperatures are important when considering proper airflow to cool the board.

Table 19. Thermal Considerations for Components

Component	Maximum Case Temperature
Processor	For processor case temperature, see processor datasheets and processor specification updates

To ensure functionality and reliability, the component is specified for proper operation when Case Temperature is maintained at or below the maximum temperature listed in Table 20. This is a requirement for sustained power dissipation equal to Thermal Design Power (TDP is specified as the maximum sustainable power to be dissipated by the components). When the component is dissipating less than TDP, the case temperature should be below the Maximum Case Temperature. The surface temperature at the geometric center of the component corresponds to Case Temperature.

It is important to note that the temperature measurement in the system BIOS is a value reported by embedded thermal sensors in the components and does not directly correspond to the Maximum Case Temperature. The upper operating limit when monitoring this thermal sensor is Tcontrol.

Table 20. Tcontrol Values for Components

Component	Tcontrol
Processor	For processor case temperature, see processor datasheets and processor specification updates

For information about	Refer to
Processor datasheets and specification updates	Section 1.2, page 19

2.7 Reliability

The Mean Time Between Failures (MTBF) prediction is calculated using component and subassembly random failure rates. The calculation is based on the Telcordia SR-332-2 Issue 2, Method I, Case 3, 55°C ambient. The MTBF prediction is used to estimate repair rates and spare parts requirements. The MTBF for the board is 61,444 hours.

2.8 Environmental

Table 21 lists the environmental specifications.

Table 21. Environmental Specifications

Parameter	Specification	
Temperature		
Non-Operating	-40 °C to +60 °C	
Operating	0 °C to +35 °C The operating temperature of the system may be determined by measuring the air temperature from the junction of the heatsink fins and fan, next to the attachment screw, in a closed chassis, while the system is in operation.	
Shock		
Unpackaged	50 g trapezoidal waveform Velocity change of 170 inches/s ²	
Packaged	Free fall package drop machine set to the height determined by the weight of the package.	
	Product Weight (pounds)	Free Fall (inches)
	<20	36
	21-40	30
	41-80	24
	81-100	18
Vibration		
Unpackaged	5 Hz to 20 Hz: 0.001 g ² /Hz sloping up to 0.01 g ² /Hz 20 Hz to 500 Hz: 0.01 g ² Hz (flat) Input acceleration is 2.20 g RMS	
Packaged	5 Hz to 40 Hz: 0.015 g ² /Hz (flat) 40 Hz to 500 Hz: 0.015 g ² /Hz sloping down to 0.00015 g ² /Hz Input acceleration is 1.09 g RMS	

Note: Before attempting to operate this system, the overall temperature of the system must be above the minimum operating temperature specified. It is recommended that the system temperature be at least room temperature before attempting to power on the system. The operating and non-operating environment must avoid condensing humidity.

3 Overview of BIOS Features

3.1 Introduction

The board uses an Intel NUC BIOS that is stored in the Serial Peripheral Interface Flash Memory (SPI Flash) and can be updated using a disk-based program. The SPI Flash contains the BIOS Setup program, POST, the PCI auto-configuration utility, LAN EEPROM information, and Plug and Play support. The initial production BIOSs are identified as INWHL357.

The BIOS Setup program can be used to view and change the BIOS settings for the computer. The BIOS Setup program is accessed by pressing the <F2> key after the Power-On Self-Test (POST) memory test begins and before the operating system boot begins.



NOTE

The config menu is displayed only when the board is in configuration mode. Section 2.3 on page 44 shows how to put the board in configuration mode (Jumper removed).

3.2 BIOS Flash Memory Organization

The Serial Peripheral Interface Flash Memory (SPI Flash) includes a 128 Mb (16384 KB) flash memory device.

3.3 System Management BIOS (SMBIOS)

SMBIOS is a Desktop Management Interface (DMI) compliant method for managing computers in a managed network.

The main component of SMBIOS is the Management Information Format (MIF) database, which contains information about the computing system and its components. Using SMBIOS, a system administrator can obtain the system types, capabilities, operational status, and installation dates for system components. The MIF database defines the data and provides the method for accessing this information. The BIOS enables applications such as third-party management software to use SMBIOS. The BIOS stores and reports the following SMBIOS information:

- BIOS data, such as the BIOS revision level
- Fixed-system data, such as peripherals, serial numbers, and asset tags
- Resource data, such as memory size, cache size, and processor speed
- Dynamic data, such as event detection and error logging

Non-Plug and Play operating systems require an additional interface for obtaining the SMBIOS information. The BIOS supports an SMBIOS table interface for such operating systems. Using this support, an SMBIOS service-level application running on a non-Plug and Play operating system can obtain the SMBIOS information. Additional board information can be found in the BIOS under the Additional Information header under the Main BIOS page.

3.4 Legacy USB Support

Legacy USB support enables USB devices to be used even when the operating system's USB drivers are not yet available. Legacy USB support is used to access the BIOS Setup program, and to install an operating system that supports USB. However, this requires the addition of USB 3.1 drivers to the operating system image prior to beginning installation. By default, Legacy USB support is set to Enabled.

Legacy USB support operates as follows:

1. When you apply power to the computer, legacy support is disabled.
2. POST begins.
3. Legacy USB support is enabled by the BIOS allowing you to use a USB keyboard to enter and configure the BIOS Setup program.
4. POST completes.
5. The operating system loads. While the operating system is loading, USB keyboards and mice are recognized and may be used to configure the operating system. (Keyboards and mice are not recognized during this period if Legacy USB support was set to Disabled in the BIOS Setup program.)
6. After the operating system loads the USB drivers, all legacy and non-legacy USB devices are recognized by the operating system, and Legacy USB support from the BIOS is no longer used. This requires the operating system to have USB 3.1 driver support in order to recognize devices attached to any of the Intel NUC's external USB ports.

To install an operating system that supports USB, verify that Legacy USB support in the BIOS Setup program is set to Enabled and follow the operating system's installation instructions.

3.5 BIOS Updates

The BIOS can be updated using either of the following utilities, which are available on the Intel World Wide Web site:

- Intel® Firmware Update Utility for Windows with a single .exe, which enables automated updating while in the Windows environment. Using this utility, the BIOS can be updated from a file on a hard disk, a USB drive (a flash drive or a USB hard drive), or from the file location on the Web.
- Intel® Firmware Update Utility, which support working on Windows, EFI shell and Linux operating systems. Using this utility, the BIOS can be updated from a file on a hard disk, or a USB drive (a flash drive or a USB hard drive).
- Intel F7 switch during POST allows a user to select where the BIOS .CAP file is located and perform the update from that location/device. Similar to performing a BIOS Recovery without removing the BIOS configuration jumper.

All utilities verify that the updated BIOS matches the target system to prevent accidentally installing an incompatible BIOS.



NOTE

Review the instructions distributed with the upgrade utility before attempting a BIOS update.

3.5.1 Language Support

The BIOS Setup program and help messages are supported in US English. Check the Intel web site for support.

3.6 BIOS Recovery

It is unlikely that anything will interrupt a BIOS update; however, if an interruption occurs, the BIOS could be damaged. Table 22 lists the drives and media types that can and cannot be used for BIOS recovery. The BIOS recovery media does not need to be made bootable.

Table 22. Acceptable Drives/Media Types for BIOS Recovery

Media Type ^(Note)	Can be used for BIOS recovery?
Hard disk drive (connected to SATA or USB)	Yes
USB flash drive	Yes
USB diskette drive (with a 1.4 MB diskette)	No (BIOS update file is bigger than 1.4 MB size limit)



NOTE

Supported file systems for BIOS recovery:

- NTFS (sparse, compressed, or encrypted files are not supported)
- FAT32
- FAT16
- FAT12

For information about	Refer to
BIOS recovery	http://www.intel.com/support/motherboards/desktop/sb/CS-034524.htm

3.7 Boot Options

In the BIOS Setup program, the user can choose to boot from a hard drive, optical drive, removable drive, or the network. The default setting is for the optical drive to be the first boot device, the hard drive second, removable drive third, and the network fourth.



NOTE

Optical drives are not supported by the onboard SATA connectors. Optical drives are supported only via the USB interfaces.

3.7.1 Network Boot

The network can be selected as a boot device. This selection allows booting from the onboard LAN or a network add-in card with a remote boot ROM installed.

Pressing the <F12> key during POST automatically forces booting from the LAN. To use this key during POST.

3.7.2 Booting Without Attached Devices

For use in embedded applications, the BIOS has been designed so that after passing the POST, the operating system loader is invoked even if the following devices are not present:

- Video adapter
- Keyboard
- Mouse

3.7.3 Changing the Default Boot Device During POST

Pressing the <F10> key during POST causes a boot device menu to be displayed. This menu displays the list of available boot devices. Table 23 lists the boot device menu options.

Table 23. Boot Device Menu Options

Boot Device Menu Function Keys	Description
<↑> or <↓>	Selects a default boot device
<Enter>	Exits the menu, and boots from the selected device
<Esc>	Exits the menu and boots according to the boot priority defined through BIOS setup

3.7.4 Power Button Menu

The Power Button Menu is accessible via the following sequence:

1. System is in S4/S5 (not G3)
2. User pushes the power button and holds it down
3. The power LED will change to its secondary color to signal the user to release the power button (approximately 3 seconds) then stop. Release immediately.
4. User releases the power button before the 4-second shutdown override.

If this boot path is taken, the BIOS will use default settings of Performance settings, ignoring settings in VPD where possible.

The BIOS will display the following prompt and wait for a keystroke:

- [ESC] Normal Boot
- [F2] BIOS Setup Menu
- [F3] Disable Fast Boot
- [F4] BIOS Recovery
- [F7] Update BIOS
- [F10] Enter Boot Menu
- [F12] Network Boot

[F3] Disable Fast Boot is only displayed if at least one Fast Boot optimization is enabled.

If an unrecognized key is hit, then the BIOS will do nothing and wait for another keystroke. If one of the listed hotkeys is hit, the BIOS will follow the indicated boot path. Password requirements must still be honored.

If Disable Fast Boot is selected, the BIOS will disable all Fast Boot optimizations and reset the system.

3.8 Hard Disk Drive Password Security Feature

The Hard Disk Drive Password Security feature blocks read and write accesses to the hard disk drive until the correct password is given. Hard Disk Drive Passwords are set in BIOS SETUP and are prompted for during BIOS POST. For convenient support of S3 resume, the system BIOS will automatically unlock drives on resume from S3. Valid length for passwords is 32 characters for max. Valid characters for passwords are ASCII codes between 0x20 and 0x7E, which includes numbers/English characters and special characters.

The User hard disk drive password, when installed, will be required upon each power-cycle until the Master Key or User hard disk drive password is submitted.

The Master Key hard disk drive password, when installed, will not lock the drive. The Master Key hard disk drive password exists as an unlock override in the event that the User hard disk drive password is forgotten. Only the installation of the User hard disk drive password will cause a hard disk to be locked upon a system power-cycle.

Table 24 shows the effects of setting the Hard Disk Drive Passwords.

Table 24. Master Key and User Hard Drive Password Functions

Password Set	Password During Boot
Neither	None
Master only	None
User only	User
Master and User Set	User (Clear Master password in BIOS setup will clear both Master and User passwords)



NOTE

The passwords are stored on the hard disk drive so if the drive is relocated to another computer that does not support Hard Disk Drive Password Security feature, the drive will not be accessible.

Currently, there is no industry standard for implementing Hard Disk Drive Password Security on AHCI or NVME drives. Hard drive encryption can still be implemented and does not require Hard Disk Drive Password Security.

3.9 BIOS Security Features

The BIOS includes security features that restrict access to the BIOS Setup program and who can boot the computer. A supervisor password and a user password can be set for the BIOS Setup program and for booting the computer, with the following restrictions:

- The supervisor password gives unrestricted access to view and change all the Setup options in the BIOS Setup program. This is the supervisor mode.
- The user password gives restricted access to view and change Setup options in the BIOS Setup program. This is the user mode.
- If only the supervisor password is set, pressing the <Enter> key at the password prompt of the BIOS Setup program allows the user restricted access to Setup.

- If both the supervisor and user passwords are set, users can enter either the supervisor password or the user password to access Setup. Users have access to Setup respective to which password is entered.
- Setting the user password restricts who can boot the computer. The password prompt will be displayed before the computer is booted. If only the supervisor password is set, the computer boots without asking for a password. If both passwords are set, the user can enter either password to boot the computer.
- For enhanced security, use different passwords for the supervisor and user passwords.
- Valid characters for passwords are ASCII codes between 0x20 and 0x7E, which includes numbers/English characters and special characters. Valid length for passwords is 2 to 20 characters.
- To clear a set password, enter a blank password after entering the existing password.

Table 25 shows the effects of setting the supervisor password and user password. This table is for reference only and is not displayed on the screen.

Table 25. Supervisor and User Password Functions

Password Set	Supervisor Mode	User Mode	Setup Options	Password to Enter Setup	Password During Boot
Neither	Can change all options (Note)	Can change all options (Note)	None	None	None
Supervisor only	Can change all options	Can change a limited number of options	Supervisor Password	Supervisor	None
User only	N/A	Can change all options	Enter Password Clear User Password	User	User
Supervisor and user set	Can change all options	Can change a limited number of options	Supervisor Password Enter Password	Supervisor or user	Supervisor or user

Note: If no password is set, any user can change all Setup options.

4 Error Messages and Blink Codes

4.1 Front-panel Power LED Blink Codes

Whenever a recoverable error occurs during POST, the BIOS causes the board's front panel power LED to blink an error message describing the problem (see Table 26).

Table 26. Front-panel Power LED Blink Codes

Type	Pattern	Note
BIOS update in progress	The BIOS will blink the front panel power LED during flash update 0.5 sec On, then 1.5 sec Off. The pattern repeats until the BIOS update is complete.	
Memory error	On-off (1.0 second each) three times, then 2.5-second pause (off), entire pattern repeats (blinks and pause) until the system is powered off.	
Thermal trip warning	Following the blink pattern: .25 seconds on, .25 seconds off, .25 seconds on, .25 seconds off in a total of 16 blinks.	

Note: Disabled per default BIOS setup option.

5 Intel NUC Kit Features

5.1 Chassis Front Panel Features

Intel NUC Boards NUC8INB can be found integrated into Intel® NUC Mini PC NUC8i5INH/NUC8i7INH. Figure 18 shows the location of the features located on or near the front of the chassis.

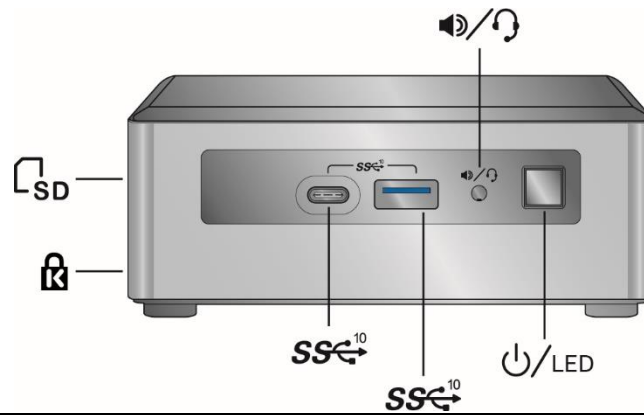







Figure 18. Intel® NUC Products NUC8i5INH/NUC8i7INH Features – Front

Table 27 lists the components identified in Figure 18.

Table 27. Components Shown in Figure 18

Item from Figure 18	Description
	Kensington* Anti-Theft Key Lock Hole
	SD Card Reader
	Power Switch and Power LED
	Speaker/Headset Jack
	USB 3.1 Gen2 Connectors
	Consumer Infrared Sensor

5.2 Chassis Rear Panel Features

Figure 19 shows the location of the features located on the rear of the chassis.

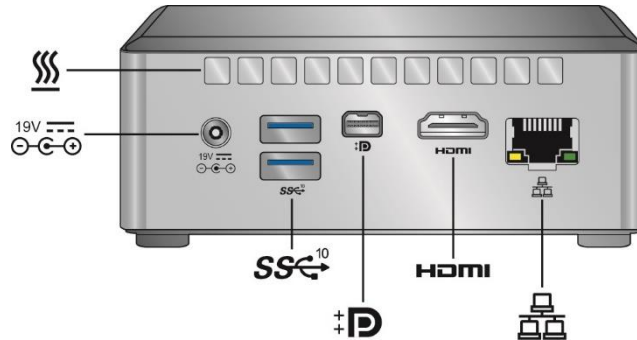
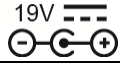







Figure 19. Intel® NUC Products NUC8i5INH/NUC8i7INH Features – Rear

Table 28 lists the components identified in Figure 19.

Table 28. Components Shown in Figure 19

Item from Figure 19	Description
	19V DC Power Inlet
	Cooling Vents
	Speaker and Optical Audio Jack
	High Definition Multimedia Interface Connectors
	Ethernet Port
	USB 3.1 Gen2 Connectors
	Mini Display Port

Mouser Electronics

Authorized Distributor

Click to View Pricing, Inventory, Delivery & Lifecycle Information:

Intel:

[BXNUC8I3INHY](#) [BXNUC8I5INHX](#) [BXNUC8I7INHX](#) [BXNUC8I3INHFA1](#) [BXNUC8I3INHFA4](#) [BXNUC8I7INHJA3](#)
[BXNUC8I7INHJA4](#) [BXNUC8I7INHP6](#) [BXNUC8I7INHPA1](#) [BXNUC8I7INHPA2](#) [BXNUC8I7INHZ6](#) [BXNUC8I5INHJA4](#)
[BXNUC8I5INHP6](#) [BXNUC8I5INHPA1](#) [BXNUC8I5INHPA2](#) [BXNUC8I7INHJA1](#) [BXNUC8I7INHJA2](#) [BXNUC8I3INHJA2](#)
[BXNUC8I3INHJA3](#) [BXNUC8I3INHT6](#) [BXNUC8I5INHJA1](#) [BXNUC8I5INHJA2](#) [BXNUC8I5INHJA3](#)



Компания «ЭлектроПласт» предлагает заключение долгосрочных отношений при поставках импортных электронных компонентов на взаимовыгодных условиях!

Наши преимущества:

- Оперативные поставки широкого спектра электронных компонентов отечественного и импортного производства напрямую от производителей и с крупнейших мировых складов;
- Поставка более 17-ти миллионов наименований электронных компонентов;
- Поставка сложных, дефицитных, либо снятых с производства позиций;
- Оперативные сроки поставки под заказ (от 5 рабочих дней);
- Экспресс доставка в любую точку России;
- Техническая поддержка проекта, помощь в подборе аналогов, поставка прототипов;
- Система менеджмента качества сертифицирована по Международному стандарту ISO 9001;
- Лицензия ФСБ на осуществление работ с использованием сведений, составляющих государственную тайну;
- Поставка специализированных компонентов (Xilinx, Altera, Analog Devices, Intersil, Interpoint, Microsemi, Aeroflex, Peregrine, Syfer, Eurofarad, Texas Instrument, Miteq, Cobham, E2V, MA-COM, Hittite, Mini-Circuits, General Dynamics и др.);

Помимо этого, одним из направлений компании «ЭлектроПласт» является направление «Источники питания». Мы предлагаем Вам помощь Конструкторского отдела:

- Подбор оптимального решения, техническое обоснование при выборе компонента;
- Подбор аналогов;
- Консультации по применению компонента;
- Поставка образцов и прототипов;
- Техническая поддержка проекта;
- Защита от снятия компонента с производства.



Как с нами связаться

Телефон: 8 (812) 309 58 32 (многоканальный)

Факс: 8 (812) 320-02-42

Электронная почта: org@eplast1.ru

Адрес: 198099, г. Санкт-Петербург, ул. Калинина, дом 2, корпус 4, литера А.