

Low Offset Hot Swappable 2-Wire Bus Buffer with Stuck Bus Recovery

FEATURES

- Bidirectional Buffer with Stuck Bus Recovery
- 60mV Buffer Offset Independent of Load
- 30ms Stuck Bus Timeout
- Compatible with Non-Compliant V_{OL} I²C Devices
- Prevents SDA and SCL Corruption During Live Board Insertion and Removal from Backplane
- $\pm 5kV$ Human Body Model ESD Protection
- Isolates Input SDA and SCL Line from Output
- Compatible with I²C™, I²C Fast Mode and SMBus
- READY Open-Drain Output
- 1V Precharge on All SDA and SCL Lines
- High Impedance SDA, SCL Pins for $V_{CC} = 0V$
- Small 8-Lead (3mm × 3mm) DFN and 8-Lead MSOP Packages

APPLICATIONS

- Live Board Insertion
- Servers
- Capacitance Buffer/Bus Extender
- RAID Systems
- ATCA

DESCRIPTION

The LTC[®]4307 hot swappable, 2-wire bus buffer allows I/O card insertion into a live backplane without corruption of the data and clock busses. The LTC4307 provides bidirectional buffering, keeping the backplane and card capacitances isolated. Low offset and high V_{OL} tolerance allows multiple devices to be cascaded on the clock and data busses. If SDAOUT or SCLOUT are low for 30ms, the LTC4307 will automatically break the bus connection. At this time the LTC4307 automatically generates up to 16 clock pulses on SCLOUT in an attempt to free the bus. A connection will resume if the stuck bus is cleared.

During insertion, the SDA and SCL lines are pre-charged to 1V to minimize bus disturbances. When driven high, the ENABLE input allows the LTC4307 to connect after a stop bit or bus idle. Driving ENABLE low breaks the connection between SDAIN and SDAOUT, SCLIN and SCLOUT. READY is an open-drain output which indicates that the backplane and card sides are connected.

LT, LT, LTC and LTM are registered trademarks of Linear Technology Corporation. All other trademarks are the property of their respective owners. Protected by U.S. Patents, including 7032051, 6356140, 6650174

TYPICAL APPLICATION

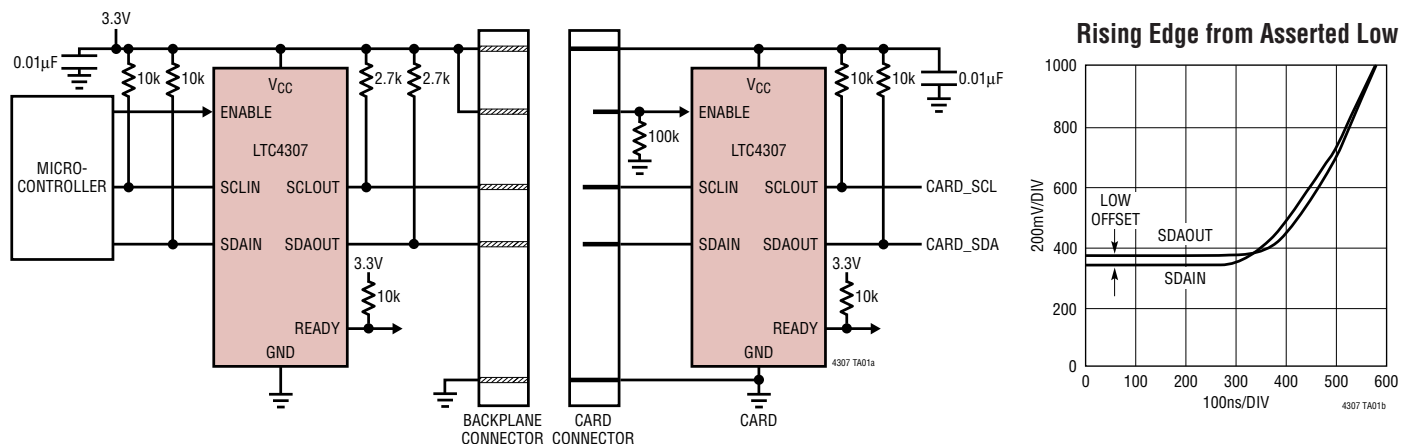

LTC4307

ABSOLUTE MAXIMUM RATINGS (Notes 1, 7)

V_{CC} to GND	-0.3V to 6V	Storage Temperature Range	
SDAIN, SCLIN, SDAOUT, SCLOUT, READY, ENABLE	-0.3V to 6V	DFN	-65°C to 125°C
Maximum Sink Current (SDAIN, SCLIN, SDAOUT, SCLOUT, READY)	50mA	MSOP	-65°C to 150°C
Operating Temperature Range		Lead Temperature (Soldering, 10 sec)	
LTC4307C	0°C to 70°C	MSOP	300°C
LTC4307I	-40°C to 85°C		

PACKAGE/ORDER INFORMATION

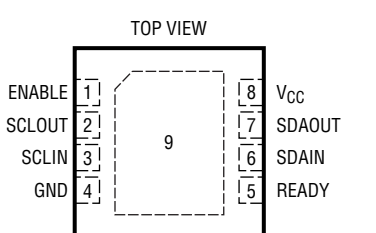
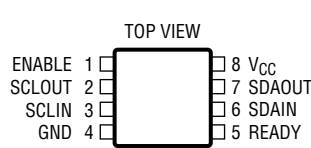
 <p>DD PACKAGE 8-LEAD (3mm × 3mm) PLASTIC DFN $T_{JMAX} = 125^{\circ}\text{C}$, $\theta_{JA} = 43^{\circ}\text{C/W}$ EXPOSED PAD (PIN 9) CONNECTION TO GND IS OPTIONAL</p>	ORDER PART NUMBER	 <p>MS8 PACKAGE 8-LEAD PLASTIC MSOP $T_{JMAX} = 125^{\circ}\text{C}$, $\theta_{JA} = 200^{\circ}\text{C/W}$</p>	ORDER PART NUMBER
	LTC4307CDD LTC4307IDD		LTC4307CMS8 LTC4307IMS8
	DD PART* MARKING		MS8 PART* MARKING
	LBTW LBTW		LTBTV LTBTV

Consult LTC Marketing for parts specified with wider operating temperature ranges. *The temperature grade is identified by a label on the shipping container.

ELECTRICAL CHARACTERISTICS

The ● denotes the specifications which apply over the full operating temperature range, otherwise specifications are at $T_A = 25^{\circ}\text{C}$. $V_{CC} = 3.3\text{V}$, unless otherwise noted.

SYMBOL	PARAMETER	CONDITIONS	MIN	TYP	MAX	UNITS
Power Supply						
V_{CC}	Positive Supply Voltage		● 2.3		5.5	V
I_{CC}	Supply Current	$V_{CC} = 5.5\text{V}$, $V_{SCLOUT} = V_{SDAOUT} = 0\text{V}$ (Note 6)	●	8	11	mA
I_{SD}	Shutdown Supply Current	$V_{CC} = 5.5\text{V}$, ENABLE = GND, SDA, SCL = 5.5V	●	900	1200	μA
V_{PRE}	Precharge Voltage	SDA, SCL Floating	● 0.8	1	1.2	V
t_{IDLE}	Bus Idle Time		● 55	95	175	μs
V_{THR_ENABLE}	ENABLE Threshold		0.8	1.4	2	V
I_{ENABLE}	ENABLE Input Current	ENABLE from 0V to V_{CC}	●	0.1	± 5	μA
t_{PLH_EN}	ENABLE Delay Off-On	$V_{CC} = 3.3\text{V}$ (Figure 1)		95		μs
t_{PHL_EN}	ENABLE Delay On-Off	$V_{CC} = 3.3\text{V}$ (Note 3) (Figure 1)		10		ns
t_{PLH_READY}	READY Delay Off-On	$V_{CC} = 3.3\text{V}$ (Note 3) (Figure 1)		10		ns
t_{PHL_READY}	READY Delay On-Off	$V_{CC} = 3.3\text{V}$ (Note 3) (Figure 1)		10		ns
V_{OL_READY}	READY Output Low Voltage	$I_{PULLUP} = 3\text{mA}$, $V_{CC} = 2.3\text{V}$	●		0.4	V
I_{OFF_READY}	READY Off Leakage Current	$V_{CC} = \text{READY} = 5.5\text{V}$	●	0.1	± 5	μA

4307f

ELECTRICAL CHARACTERISTICS

The ● denotes the specifications which apply over the full operating temperature range, otherwise specifications are at $T_A = 25^\circ\text{C}$. $V_{CC} = 3.3\text{V}$, unless otherwise noted.

SYMBOL	PARAMETER	CONDITIONS	MIN	TYP	MAX	UNITS	
Propagation Delay and Rise-Time Accelerators							
t_{PHL}	SDA/SCL Propagation Delay High to Low	$C_{LOAD} = 50\text{pF}$, 2.7k to V_{CC} on SDA, SCL, $V_{CC} = 3.3\text{V}$ (Notes 2, 3) (Figure 1)		70		ns	
t_{PLH}	SDA/SCL Propagation Delay Low to High	$C_{LOAD} = 50\text{pF}$, 2.7k to V_{CC} on SDA, SCL, $V_{CC} = 3.3\text{V}$ (Notes 2, 3) (Figure 1)		10		ns	
t_{RISE}	SDA/SCL Transition Time Low to High	$C_{LOAD} = 100\text{pF}$, 10k to V_{CC} on SDA, SCL, $V_{CC} = 3.3\text{V}$ (See Notes 3, 4) (Figure 1)		30	300	ns	
t_{FALL}	SDA/SCL Transition Time High to Low	$C_{LOAD} = 100\text{pF}$, 10k to V_{CC} on SDA, SCL, $V_{CC} = 3.3\text{V}$ (See Notes 3, 4) (Figure 1)		30	300	ns	
$I_{PULLUPAC}$	Transient Boosted Pull-Up Current	Positive Transition on SDA, SCL, $V_{CC} = 3.3\text{V}$ (Note 5)	5	8		mA	
Input-Output Connection							
V_{OS}	Input-Output Offset Voltage	2.7k to V_{CC} on SDA, SCL, $V_{CC} = 3.3\text{V}$, Driven SDA/SCL = 0.2V	●	20	60	100	mV
V_{THR}	SDA, SCL Logic Input Threshold Voltage	Rising Edge		$0.45V_{CC}$	$0.55V_{CC}$	$0.65V_{CC}$	V
V_{HYS}	SDA, SCL Logic Input Threshold Voltage Hysteresis	(Note 3)		50			mV
C_{IN}	Digital Input Capacitance SDAIN, SDAOUT, SCLIN, SCLOUT	(Note 3)			10		pF
I_{LEAK}	Input Leakage Current	SDA, SCL, Pins	●		± 5		μA
V_{OL}	Output Low Voltage	SDA, SCL Pins, $I_{SINK} = 4\text{mA}$, Driven SDA/SCL = 0.2V, $V_{CC} = 2.7\text{V}$	●	0		0.4	V
		2.7k to V_{CC} on SDA, SCL, $V_{CC} = 3.3\text{V}$, Driven SDA/SCL = 0.1V	●	120	160	205	mV
V_{ILMAX}	Buffer Input Logic Low Voltage	$V_{CC} = 3.3\text{V}$	●			1.2	V
Bus Stuck Low Timeout							
$t_{TIMEOUT}$	Bus Stuck Low Timer	$V_{CC} = 3.3\text{V}$, SDAOUT, SCLOUT = 0V	●	25	30	35	ms
Timing Characteristics							
$f_{I2C,MAX}$	I ² C Maximum Operating Frequency	(Note 3)		400	600		kHz
t_{BUF}	Bus Free Time Between Stop and Start Condition	(Note 3)			1.3		μs
$t_{HD,STA}$	Hold Time After (Repeated) Start Condition	(Note 3)			100		ns
$t_{SU,STA}$	Repeated Start Condition Set-Up Time	(Note 3)			0		ns
$t_{SU,STO}$	Stop Condition Set-Up Time	(Note 3)			0		ns
$t_{HD,DATI}$	Data Hold Time Input	(Note 3)			0		ns
$t_{SU,DAT}$	Data Set-Up Time	(Note 3)			100		ns

Note 1: Stresses beyond those listed under Absolute Maximum Ratings may cause permanent damage to the device. Exposure to any Absolute Maximum Rating condition for extended periods may affect device reliability and lifetime.

Note 2: See "Propagation Delays" in the Operations section for a discussion of t_{PHL} and t_{PLH} as a function of pull-up resistance and bus capacitance.

Note 3: Determined by design, not tested in production.

Note 4: Measure points are $0.3 \cdot V_{CC}$ and $0.7 \cdot V_{CC}$.

Note 5: I_{PULLUP} varies with temperature and V_{CC} voltage as shown in the Typical Performance Characteristics section.

Note 6: I_{CC} test performed with connection circuitry active.

Note 7: All currents into pins are positive; all voltages are referenced to GND unless otherwise specified.

TIMING DIAGRAMS

ENABLE, CONNECT, READY Timing

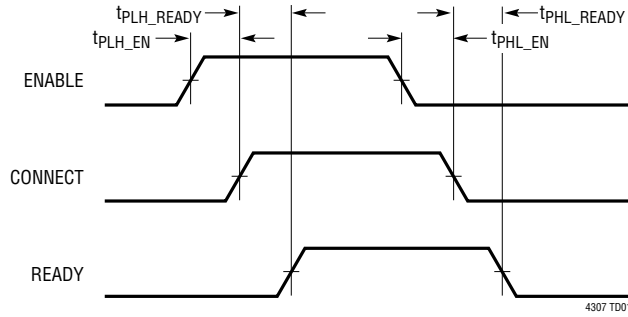

Rising and Falling Propagation Delay and Rise and Fall Times for SDAIN, SDAOUT and SCLIN, SCLOUT

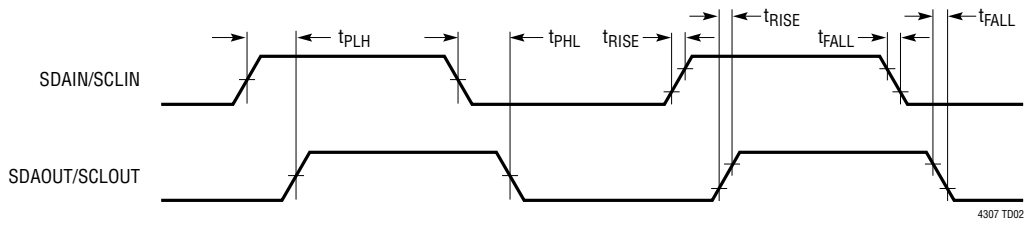
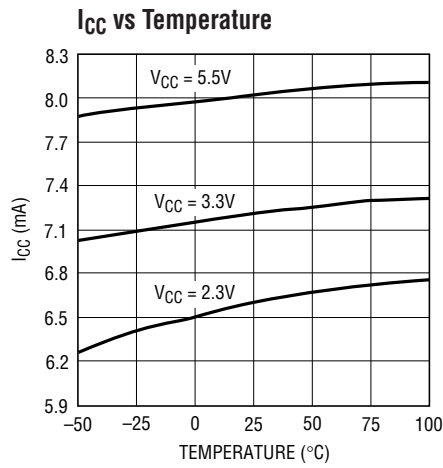
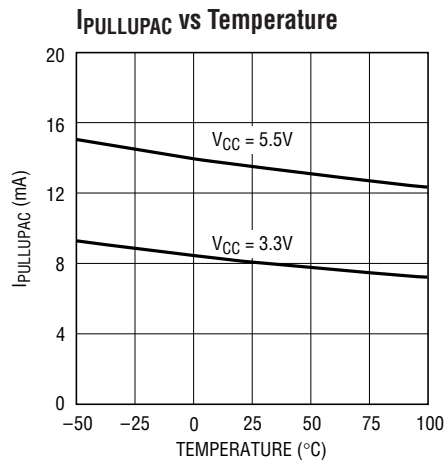

Figure 1. Timing Diagrams

TYPICAL PERFORMANCE CHARACTERISTICS $T_A = 25^\circ\text{C}$, $V_{CC} = 3.3\text{V}$, unless otherwise indicated.



4307 G01



4307 G02

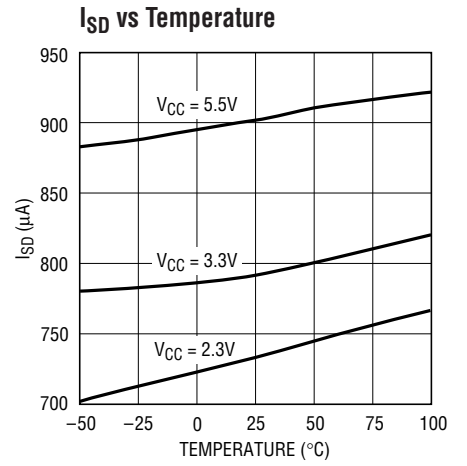

4307 G02

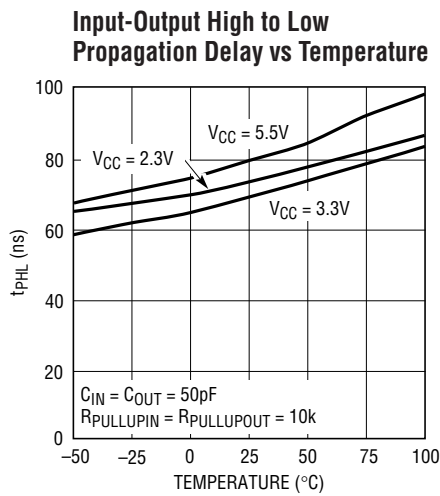

4307 G04

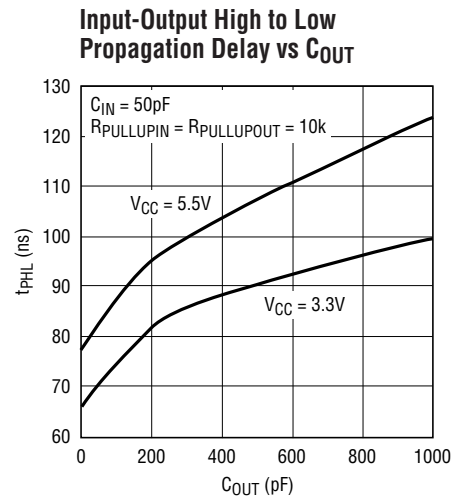

4307 G07

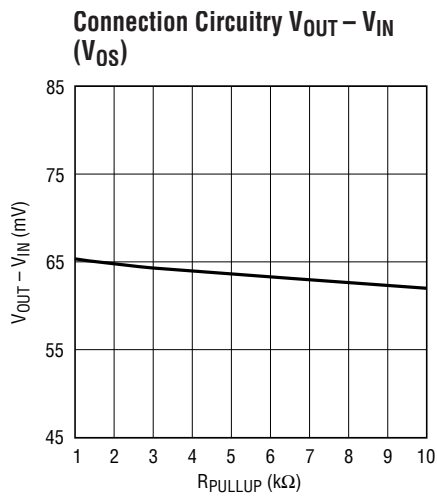

4307 G05

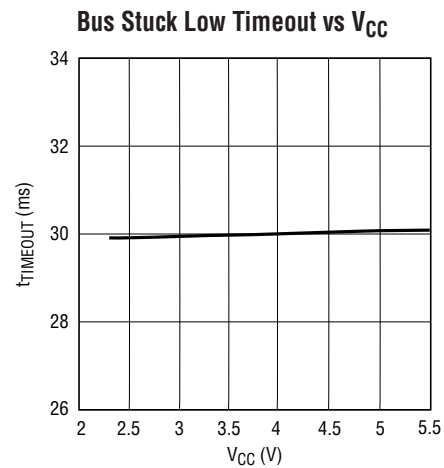

4307 G06

PIN FUNCTIONS

ENABLE (Pin 1): Connection Enable Input. This is a 1.4V digital threshold input pin. For normal operation pull or tie ENABLE high. Driving ENABLE below 0.8V isolates SDAIN from SDAOUT, SCLIN from SCLOUT and asserts READY low. A rising edge on ENABLE after a fault has occurred forces a connection between SDAIN, SDAOUT and SCLIN, SCLOUT. Connect to V_{CC} if unused.

SCLOUT (Pin 2): Serial Clock Output. Connect this pin to an SCL bus segment where stuck bus recovery is needed. A pull-up resistor should be connected between this pin and V_{CC} .

SCLIN (Pin 3): Serial Clock Input. Connect this pin to an SCL bus segment that needs to be isolated from stuck bus problems. A pull-up resistor should be connected between this pin and V_{CC} .

GND (Pin 4): Device Ground. Connect this pin to a ground plane for best results.

READY (Pin 5): Connection READY Status Output. The READY pin is an open-drain N-channel MOSFET output that pulls low when ENABLE is low, or when the start-up and

connection sequence described in the Operation section has not been completed. READY also goes low when the LTC4307 disconnects the inputs from the outputs due to the bus being stuck low for at least 30ms. READY goes high when ENABLE is high and a connection is made. Connect a pull-up resistor, typically 10k, from this pin to V_{CC} to provide the pull-up. This pin can be floated if unused.

SDAIN (Pin 6): Serial Data Input. Connect this pin to an SDA bus segment that needs to be isolated from stuck bus problems. A pull-up resistor should be connected between this pin and V_{CC} .

SDAOUT (Pin 7): Serial Data Output. Connect this pin to the SDA bus segment where stuck bus recovery is needed. A pull-up resistor should be connected between this pin and V_{CC} .

V_{CC} (Pin 8): Supply Voltage Input. Place a bypass capacitor of at least 0.01 μ F close to V_{CC} for best results.

Exposed Pad (Pin 9, DFN Package Only): Exposed Pad may be left open or connected to device ground.

BLOCK DIAGRAM

Low Offset 2-Wire Bus Buffer with Stuck Low Timeout

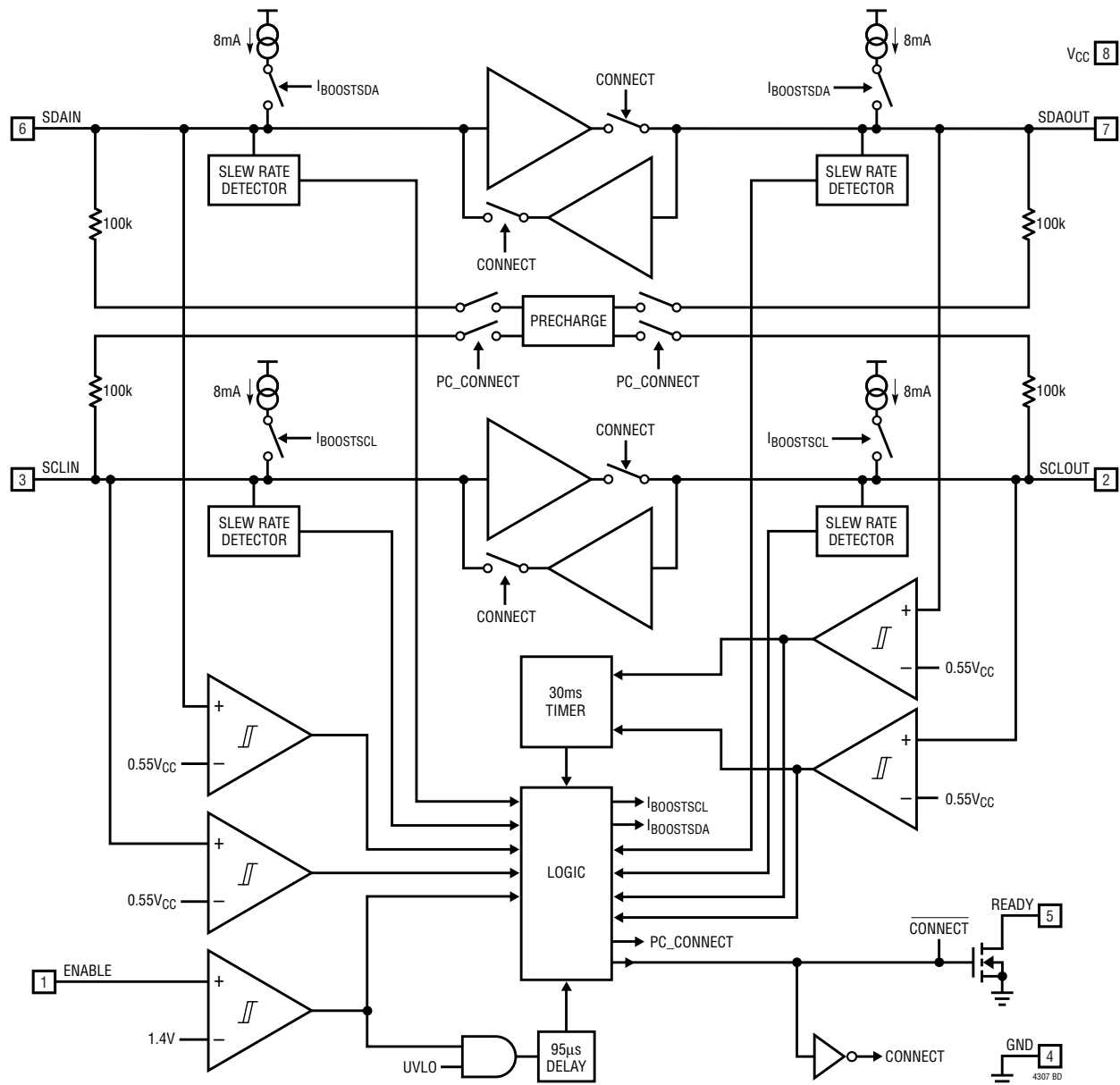

OPERATION

Start-Up

When the LTC4307 first receives power on its V_{CC} pin, either during power-up or live insertion, it starts in an undervoltage lockout (UVLO) state, ignoring any activity on the SDA or SCL pins until V_{CC} rises above 2V (typ). This is to ensure that the LTC4307 does not try to function until it has enough voltage to do so.

During this time, the 1V precharge circuitry is active and forces 1V through 100k nominal resistors to the SDA and SCL pins. Because the I/O card is being plugged into a live backplane, the voltage on the backplane SDA and SCL busses may be anywhere between 0V and V_{CC} . Precharging the SCL and SDA pins to 1V minimizes the worst-case voltage differential these pins will see at the

OPERATION

moment of connection, therefore minimizing the amount of disturbance caused by the I/O card.

Once the LTC4307 comes out of UVLO, it monitors both the backplane and card sides for either a stop bit or bus idle condition to indicate the completion of data transactions. When both sides are idle or one side has a stop bit condition while the other is idle, the input-to-output connection circuitry is activated, joining the SDA and SCL busses on the I/O card with those on the backplane. In addition, the precharge circuitry is deactivated and will not be reactivated unless the V_{CC} voltage falls below the UVLO threshold.

Connection Circuitry

Once the connection circuitry is activated, the functionality of the SDAIN and SDAOUT pins is identical. A low forced on either pin at any time results in both pin voltages being low. The LTC4307 is tolerant of I²C bus DC logic low voltages up to the $0.3V_{CC} V_{IL}$ I²C specification.

When the LTC4307 senses a rising edge on the bus, it deactivates its pull-down devices for bus voltages as low as 0.48V and activates its accelerators. This methodology maximizes the effectiveness of the rise time accelerator circuitry and maintains compatibility with the other devices in the LTC4300 bus buffer family. Care must be taken to ensure that devices participating in clock stretching or arbitration force logic low voltages below 0.48V at the LTC4307 inputs.

SDAIN and SDAOUT enter a logic high state only when all devices on both SDAIN and SDAOUT release high. The same is true for SCLIN and SCLOUT. This important feature ensures that clock stretching, clock synchronization, arbitration and the acknowledge protocol always work, regardless of how the devices in the system are tied to the LTC4307.

Another key feature of the connection circuitry is that it provides bidirectional buffering, keeping the backplane and card capacitances isolated. Because of this isolation, the waveforms on the backplane busses look slightly different than the corresponding card bus waveforms as described here.

Input to Output Offset Voltage

When a logic low voltage, V_{LOW1} , is driven on any of the LTC4307's data or clock pins, the LTC4307 regulates the voltage on the opposite data or clock pins to a slightly higher voltage, typically 60mV above V_{LOW1} . This offset is practically independent of pull-up current (see the Typical Performance curves).

Propagation Delays

During a rising edge, the rise time on each side is determined by the bus pull-up resistor and the equivalent capacitance on the line. If the pull-up resistors are the same, a difference in rise time occurs which is directly proportional to the difference in capacitance between the two sides. This effect is displayed in Figure 2 for $V_{CC} = 5.5V$ and a 10k pull-up resistor on each side (50pF on one side and 150pF on the other). Since the output side has less capacitance than the input, it rises faster and the effective propagation delay is negative.

There is a finite propagation delay through the connection circuitry for falling waveforms. Figure 3 shows the falling edge waveforms for the same pull-up resistors and equivalent capacitance conditions as used in Figure 2. An external N-channel MOSFET device pulls down the voltage on the side with 150pF capacitance; the LTC4307 pulls down the voltage on the opposite side with a delay of 80ns. This delay is always positive and is a function of supply voltage, temperature and the pull-up resistors and equivalent bus capacitances on both sides of the bus. The Typical Performance Characteristics section shows propagation delay as a function of temperature and voltage for 10k pull-up resistors and 50pF equivalent capacitance on both sides of the part. Also, the t_{PHL} vs C_{OUT} curve for $V_{CC} = 5.5V$ shows that increasing the capacitance from 50pF to 150pF results in a t_{PHL} increase from 81ns to 91ns. Larger output capacitances translate to longer delays (up to 125ns). Users must quantify the difference in propagation times for a rising edge versus a falling edge in their systems and adjust setup and hold times accordingly.

OPERATION

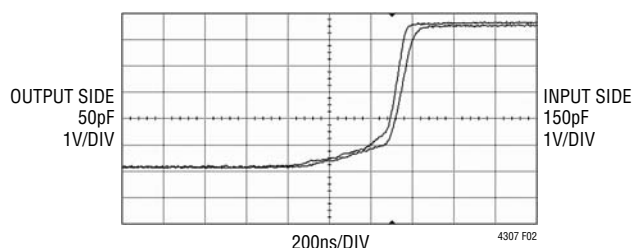

Figure 2. Input-Output Rising Edge Waveforms

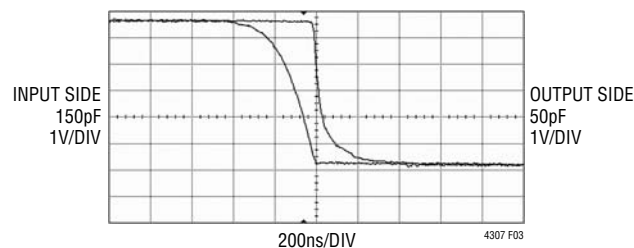

Figure 3. Input-Output Falling Edge Waveforms

Bus Stuck Low Timeout

When SDAOUT or SCLOUT is low, an internal timer is started. The timer is only reset by that respective input going high. If it does not go high within 30ms (typical) the connection between SDAIN and SDAOUT, and between SCLIN and SCLOUT is broken. After at least 40 μ s, the LTC4307 automatically generates up to 16 clock pulses at 8.5kHz (typical) on SCLOUT in an attempt to unstick the bus. When the clock pulses are completed, a stop bit will be generated on SCLOUT and SDAOUT to reset any circuitry on that bus. When the low SDAOUT or SCLOUT pin goes high, a connection is enabled waiting for a stop bit or a bus idle to make a connection.

When powering up into a bus stuck low condition, the connection circuitry joining the SDA and SCL busses on the I/O card with those on the backplane is not activated and is only reset when SDAOUT and SCLOUT are high. 30ms after UVLO, automatic clocking takes place as described above.

READY Digital Output

This pin provides a digital flag which is low when either ENABLE is low, the start-up sequence described earlier in this section has not been completed, or the LTC4307 has disconnected due to a stuck bus condition. READY goes high when ENABLE is high and the backplane and card sides are connected. The pin is driven by an open-drain pull-down capable of sinking 3mA while holding 0.4V on the pin. Connect a resistor to V_{CC} to provide the pull-up.

ENABLE

When the ENABLE pin is driven below 0.8V with respect to the LTC4307's ground, the backplane side is disconnected from the card side and the READY pin is internally pulled

low. When the pin is driven above 2V, the part waits for data transactions on both the backplane and card sides to be complete (as described in the Start-Up section) before connecting the two sides. At this time the internal pull-down on READY releases. When ENABLE is low, automatic clocking is disabled.

A rising edge on ENABLE after a bus stuck low condition has occurred forces a connection between SDAIN, SDAOUT, and SCLIN, SCLOUT even if the bus stuck low condition has not been cleared. At this time the 30ms timer is reset but not disabled.

Rise Time Accelerators

Once connection has been established, rise time accelerator circuits on all four SDA and SCL pins are enabled. During positive bus transitions, the rise time accelerators provide strong, slew-limited pull-up currents that make the bus voltage rise at a rate of 100V/ μ s. The rise time accelerators significantly improve system reliability in two ways. First, they provide smooth, controlled transitions during rising edges for both small and large systems. Because the accelerator pull-up impedance is significantly lower than the bus pull-up resistance, the system is much less susceptible to noise on rising edges. Second, the accelerators allow users to choose large bus pull-up resistors, reducing power consumption and improving logic low noise margin.

For these reasons, it is strongly recommended that users choose bus pull-up resistors so that the bus will rise on its own at a rate of at least 0.8V/ μ s to guarantee activation of the accelerators. The rise time accelerators are disabled until the sequence of events described in the start-up section has been completed. They are also disabled during automatic clocking.

APPLICATIONS INFORMATION

Live Insertion and Capacitance Buffering Application

Figures 4 and 5 illustrate applications of the LTC4307 that take advantage of the LTC4307's Hot Swap™, capacitance buffering and precharge features. If the I/O cards were plugged directly into the backplane without the LTC4307 buffer, all of the backplane and card capacitances would add directly together, making rise-time and fall-time requirements difficult to meet. Placing an LTC4307 on the edge of each card, however, isolates the card capacitance from the backplane. For a given I/O card, the LTC4307 drives the capacitance of everything on the card and the backplane must drive only the capacitance of the LTC4307, which is less than 10pF.

Hot Swap is a trademark of Linear Technology Corporation.

In most applications the LTC4307 will be used with a staggered connector where V_{CC} and GND will be long pins. SDA and SCL are medium length pins to ensure that the V_{CC} and GND pins make contact first. This will allow the precharge circuitry to be activated on SDA and SCL before they make contact. ENABLE is a short pin that is pulled down when not connected. This is to ensure that the connection between the backplane and the card's data and clock busses is not enabled until the transients associated with live insertion have settled.

Figure 4 shows the LTC4307 in an application with a staggered connector. The LTC4307 receives its V_{CC} voltage from one of the long "early power" pins. Establishing early power V_{CC} ensures that the 1V precharge voltage is present at SDAIN and SCLIN before they make contact.

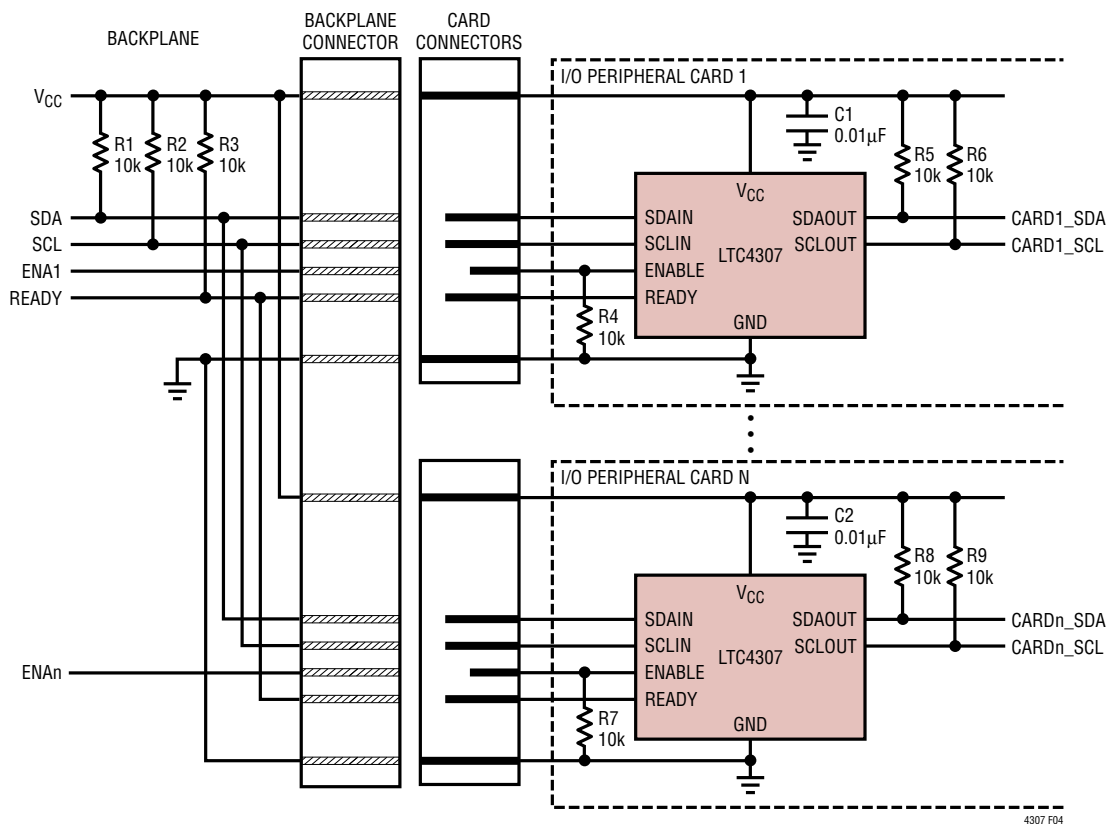

Figure 4. The LTC4307 in an Application with a Staggered Connector

APPLICATIONS INFORMATION

The ENABLE pin is driven using a short pin. This is to ensure that a connection is not enabled until the transients associated with live insertion have settled.

Figure 5 shows the LTC4307 in an application where all of the pins have the same length. In this application a resistor is used to hold the ENABLE pin low during live insertion, until the backplane control circuitry can enable the device.

Repeater/Bus Extender Applications

Users who wish to connect two 2-wire systems separated by a distance can do so by connecting two LTC4307s back-to-back, as shown in Figure 6. The I²C specification allows for 400pF maximum bus capacitance, severely limiting the length of the bus. The SMBus specification places no restriction on bus capacitance, but the limited impedances of devices connected to the bus require systems to remain small if rise time and fall time specifications are to be met. In this situation, the differential ground voltage between the two systems may limit the allowed distance, because

a valid logic-low voltage with respect to the ground at one end of the system may violate the allowed V_{OL} specification with respect to the ground at the other end. In addition, the connection circuitry offset voltages of the back-to-back LTC4307s add together, directly contributing to the same problem.

Figure 7 further illustrates a repeater application. This circuit could be used in an AdvancedTCA system. In AdvancedTCA applications, the bus pull-up resistance on the backplane is quite small. Since there is no effect on the offset due to the pull-up impedance, multiple LTC4307 buffers can be used in a single system. This allows the user to divide the line and device capacitances into more sections with buffering and meet rise and fall times.

The LTC4307 disconnects when both bus I/Os are above 0.48V and rising. In systems with large ground bounce, if many devices are cascaded, the 0.48V threshold can be exceeded and the transients associated with the ground bounce can appear to be a rising edge. Under this condition, the LTC4307 with inputs above 0.48V may disconnect.

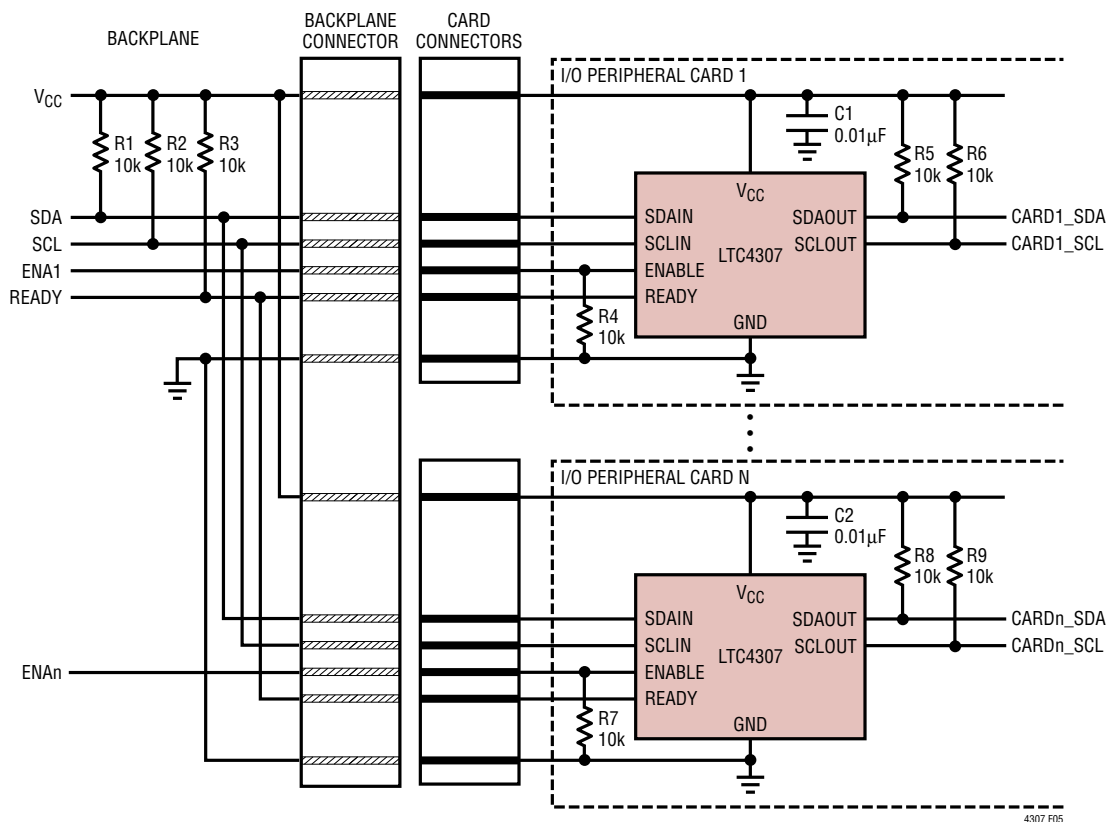

Figure 5. The LTC4307 in an Application Where All the Pins Have the Same Length

APPLICATIONS INFORMATION

Systems with Supply Voltage Droop

In large 2-wire systems, the V_{CC} voltages seen by devices at various points in the system can differ by a few hundred

millivolts or more. This situation is modeled by a series resistor in the V_{CC} line, as shown in Figure 8. For proper operation, make sure that the $V_{CC}(\text{LTC4307})$ is $\geq 2.3\text{V}$.

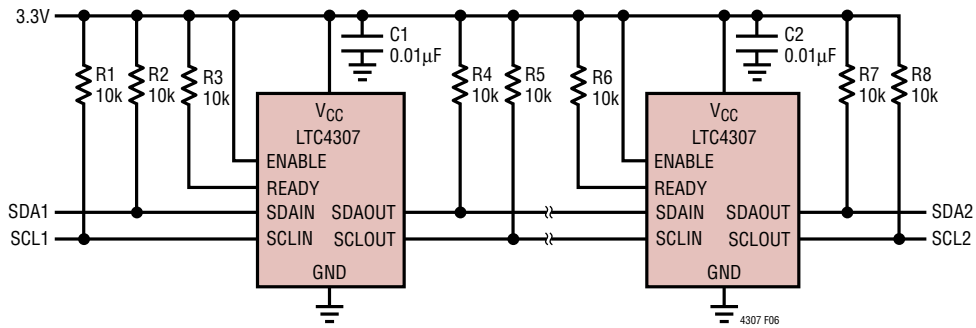

Figure 6. The LTC4307 in a Repeater/Bus Extender Application Where Two 2-Wire Systems are Separated by a Distance

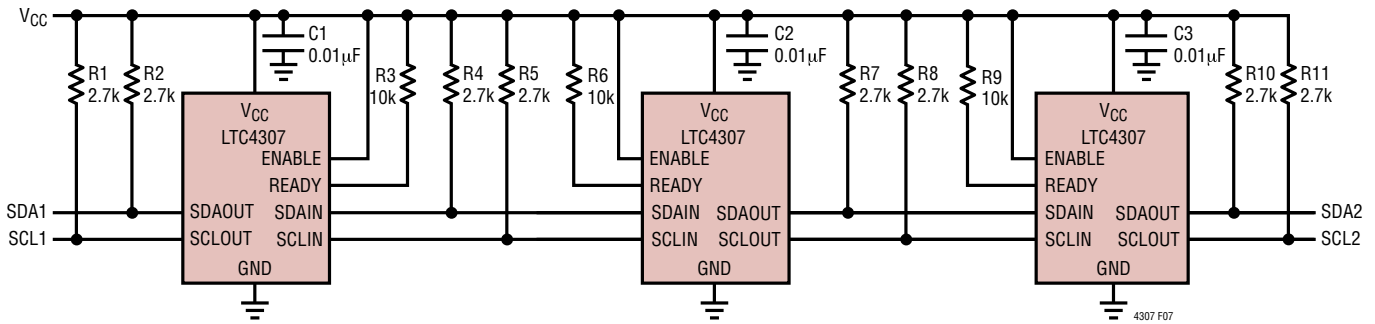

Figure 7. The LTC4307 in a Repeater Application. The LTC4307's Low Offset Allows Cascading of Multiple Devices

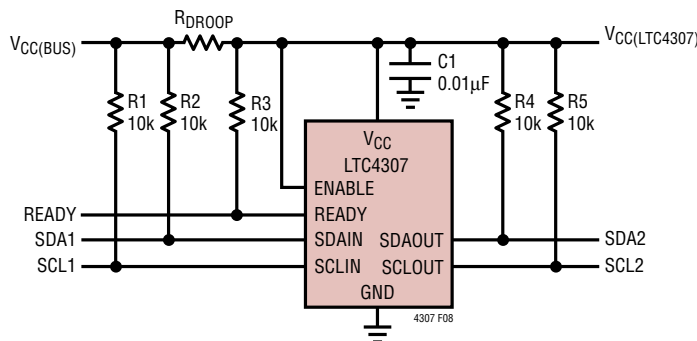
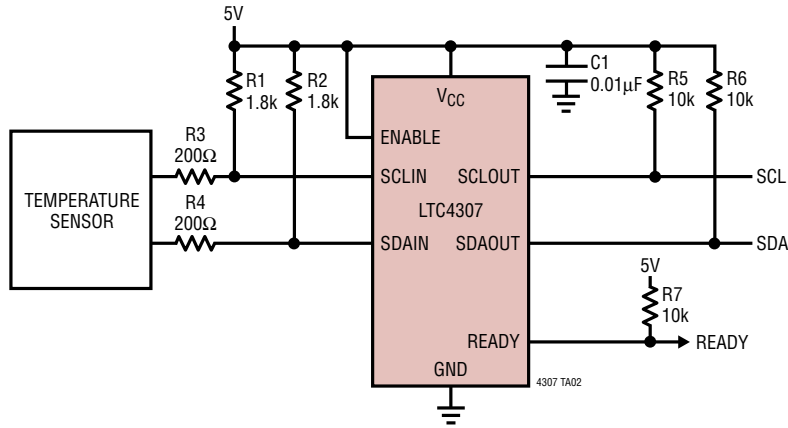

Figure 8. System with Voltage Droop

TYPICAL APPLICATIONS

High V_{IL} Application



Simplified ATCA IPMB Application

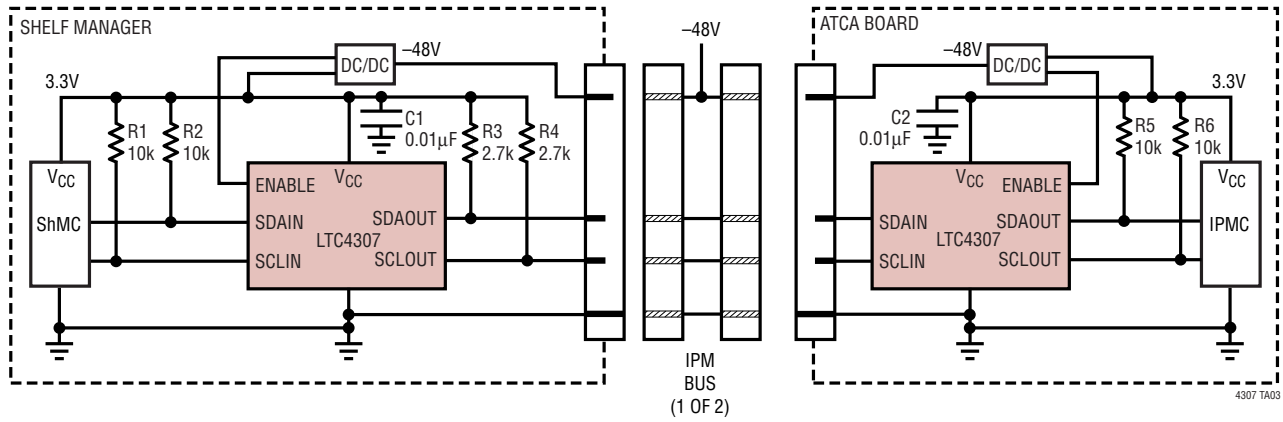

PACKAGE DESCRIPTION

DD Package
8-Lead Plastic DFN (3mm × 3mm)
 (Reference LTC DWG # 05-08-1698)

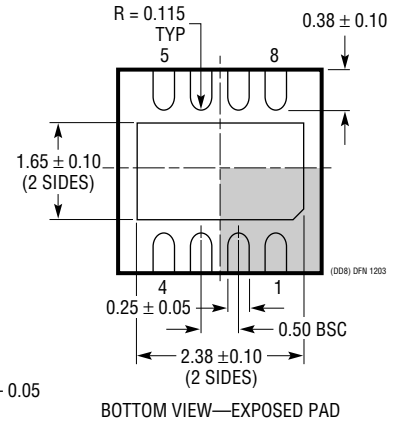
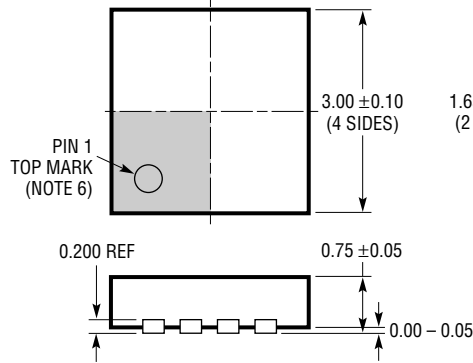
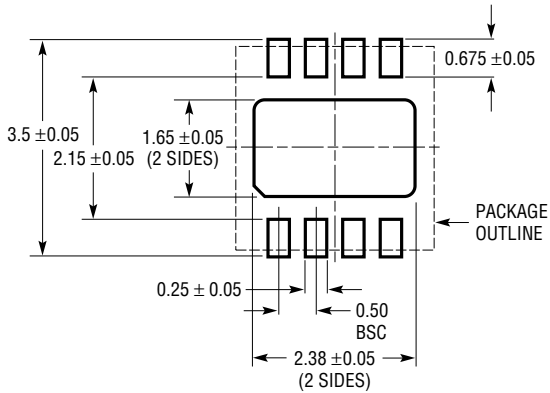

RECOMMENDED SOLDER PAD PITCH AND DIMENSIONS

- NOTE:
1. DRAWING TO BE MADE A JEDEC PACKAGE OUTLINE MO-229 VARIATION OF (WEED-1)
 2. DRAWING NOT TO SCALE
 3. ALL DIMENSIONS ARE IN MILLIMETERS
 4. DIMENSIONS OF EXPOSED PAD ON BOTTOM OF PACKAGE DO NOT INCLUDE MOLD FLASH. MOLD FLASH, IF PRESENT, SHALL NOT EXCEED 0.15mm ON ANY SIDE
 5. EXPOSED PAD SHALL BE SOLDER PLATED
 6. SHADED AREA IS ONLY A REFERENCE FOR PIN 1 LOCATION ON TOP AND BOTTOM OF PACKAGE

PACKAGE DESCRIPTION

MS8 Package 8-Lead Plastic MSOP

(Reference LTC DWG # 05-08-1660 Rev F)

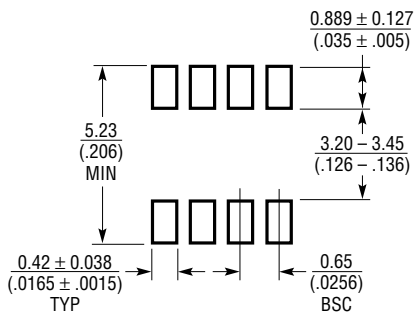

RECOMMENDED SOLDER PAD LAYOUT

NOTE:

1. DIMENSIONS IN MILLIMETER/(INCH)
2. DRAWING NOT TO SCALE
3. DIMENSION DOES NOT INCLUDE MOLD FLASH, PROTRUSIONS OR GATE BURRS.
MOLD FLASH, PROTRUSIONS OR GATE BURRS SHALL NOT EXCEED 0.152mm (.006") PER SIDE
4. DIMENSION DOES NOT INCLUDE INTERLEAD FLASH OR PROTRUSIONS.
INTERLEAD FLASH OR PROTRUSIONS SHALL NOT EXCEED 0.152mm (.006") PER SIDE
5. LEAD COPLANARITY (BOTTOM OF LEADS AFTER FORMING) SHALL BE 0.102mm (.004") MAX

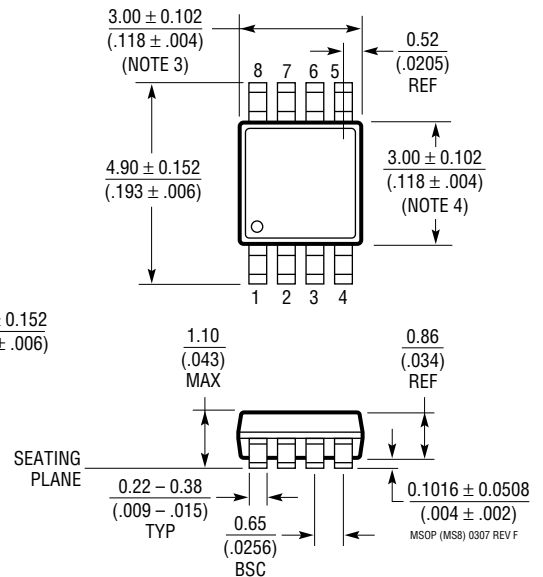
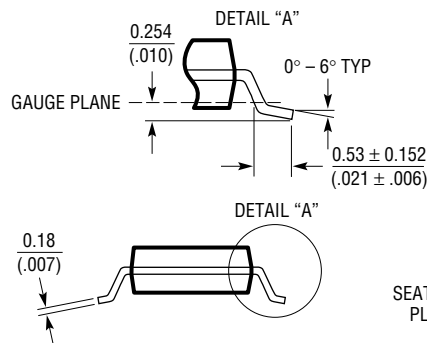

TYPICAL APPLICATION

The LTC4307 in a Repeater Application. The LTC4307's Low Offset Allows Cascading of Multiple Devices

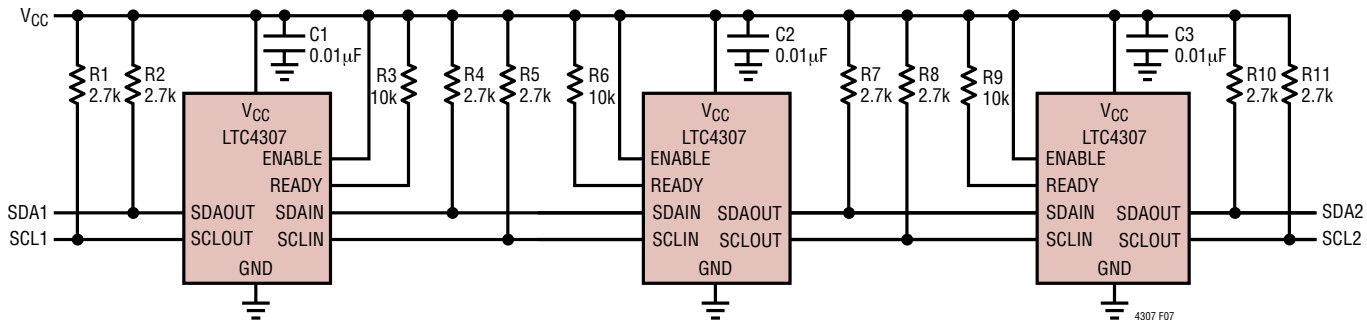

RELATED PARTS

PART NUMBER	DESCRIPTION	COMMENTS
LTC1380/LTC1393	Single-Ended 8-Channel/Differential 4-Channel Analog MUX with SMBus Interface	Low R_{ON} : 35 Ω Single Ended/70 Ω Differential, Expandable to 32 Single or 16 Differential Channels
LTC1427-50	Micropower, 10-Bit Current Output DAC with SMBus Interface	Precision 50 μ A \pm 2.5% Tolerance Over Temperature, Four Selectable SMBus Addresses, DAC Powers Up at Zero or Midscale
LTC1623	Dual High Side Switch Controller with SMBus Interface	Eight Selectable Addresses/16-Channel Capability
LTC1663	SMBus Interface 10-Bit Rail-to-Rail Micropower DAC	DNL < 0.75LSB Max, 5-Lead SOT-23 Package
LTC1694/LTC1694-1	SMBus Accelerator	Improved SMBus/ I^2 C Rise Time, Ensures Data Integrity with Multiple SMBus/ I^2 C Devices
LTC1695	SMBus/ I^2 C Fan Speed Controller in ThinSOT™ Package	0.75 Ω PMOS 180mA Regulator, 6-Bit DAC
LT1786F	SMBus Controlled CCFL Switching Regulator	1.25A, 200kHz Floating or Grounded Lamp Configurations
LTC1840	Dual I^2 C Fan Speed Controller	Two 100 μ A 8-Bit DACs, Two Tach Inputs, Four GPIO
LTC4300A-1/ LTC4300A-2/ LTC4300A-3	Hot Swappable 2-Wire Bus Buffers	LTC4300A-1: Bus Buffer with READY, ACC and ENABLE LTC4300A-2: Dual Supply Bus Buffer with READY and ACC LTC4300A-3: Dual Supply Bus Buffer with READY and ENABLE
LTC4301	Supply Independent Hot Swappable 2-Wire Bus Buffer	Supply Independent
LTC4301L	Hot Swappable 2-Wire Bus Buffer with Low Voltage Level Translation	Allows Bus Pull-Up Voltages as Low as 1V on SDAIN and SCLIN
LTC4302-1/LTC4302-2	Addressable 2-Wire Bus Buffer	Address Expansion, GPIO, Software Controlled
LTC4303/LTC4304	Hot Swappable 2-Wire Bus Buffers with Stuck Bus Recovery	Provides Automatic Clacking to Free Stuck I^2 C Busses
LTC4305/LTC4306	2-/4-Channel, 2-Wire Bus Multiplexers with Capacitance Buffering	2/4 Selectable Downstream Busses, Stuck Bus Disconnect, Rise Time Accelerators, Fault Reporting, \pm 10kV HBM ESD Tolerance

ThinSOT is a trademark of Linear Technology Corporation



Компания «ЭлектроПласт» предлагает заключение долгосрочных отношений при поставках импортных электронных компонентов на взаимовыгодных условиях!

Наши преимущества:

- Оперативные поставки широкого спектра электронных компонентов отечественного и импортного производства напрямую от производителей и с крупнейших мировых складов;
- Поставка более 17-ти миллионов наименований электронных компонентов;
- Поставка сложных, дефицитных, либо снятых с производства позиций;
- Оперативные сроки поставки под заказ (от 5 рабочих дней);
- Экспресс доставка в любую точку России;
- Техническая поддержка проекта, помощь в подборе аналогов, поставка прототипов;
- Система менеджмента качества сертифицирована по Международному стандарту ISO 9001;
- Лицензия ФСБ на осуществление работ с использованием сведений, составляющих государственную тайну;
- Поставка специализированных компонентов (Xilinx, Altera, Analog Devices, Intersil, Interpoint, Microsemi, Aeroflex, Peregrine, Syfer, Eurofarad, Texas Instrument, Miteq, Cobham, E2V, MA-COM, Hittite, Mini-Circuits, General Dynamics и др.);

Помимо этого, одним из направлений компании «ЭлектроПласт» является направление «Источники питания». Мы предлагаем Вам помощь Конструкторского отдела:

- Подбор оптимального решения, техническое обоснование при выборе компонента;
- Подбор аналогов;
- Консультации по применению компонента;
- Поставка образцов и прототипов;
- Техническая поддержка проекта;
- Защита от снятия компонента с производства.



Как с нами связаться

Телефон: 8 (812) 309 58 32 (многоканальный)

Факс: 8 (812) 320-02-42

Электронная почта: org@eplast1.ru

Адрес: 198099, г. Санкт-Петербург, ул. Калинина, дом 2, корпус 4, литера А.