

SERIES 100A SWITCHES

TOGGLE SWITCHES - MINIATURE



FEATURES & BENEFITS

- ▶ Variety of switching functions
- ▶ Miniature
- ▶ Multiple actuator & bushing options
- ▶ Sealed to IP67

APPLICATIONS/MARKETS

- ▶ Telecommunications
- ▶ Instrumentation
- ▶ Networking
- ▶ Medical equipment

SPECIFICATIONS

Contact Rating:	Dependent upon contact material
Life Expectancy:	30,000 make-and-break cycles at full load
Contact Resistance:	10 mΩ max. typical initial @ 2-4 VDC 100 mA for both silver and gold plated contacts
Insulation Resistance:	1,000 MΩ min.
Dielectric Strength:	1,000 V RMS @ sea level
Operating Temperature:	-30° C to 85° C

MATERIALS

Case & Bushing:	PBT
Pedestal of Case:	LPC
Actuator:	Brass, chrome plated with internal O-ring seal
Switch Support:	Brass or steel tin plated
Contacts / Terminals:	Silver or gold plated copper alloy

HOW TO ORDER

SERIES	MODEL NO.	ACTUATOR	BUSHING	TERMINATION	CONTACT MATERIAL	SEAL	HARDWARE
100A	□ □ □ □	□ □	□ □	□ □ □ □	□	E	□
	WSP1 WSP2 WSP3 WSP4 WSP5 WDP1 WDP2 WDP3 WDP4 WDP5	T1 T2	B1 B4	M1 M2 M5 M6 M7 VS2 VS3	Q = Silver R = Gold	E = Epoxy Sealed at Base of Terminal	H = Hardware

Example Ordering Number

100A-WDP4-T1-B4-M1-R-E

Specifications subject to change without notice.

SPDT



2 Comm.



SCHEMATIC

Model No.	POS 1	POS 2	POS 3
WSP-1	ON	NONE	ON
WSP-2	ON	NONE	(ON)
WSP-3	ON	OFF	ON
WSP-4	(ON)	OFF	(ON)
WSP-5	ON	OFF	(ON)
Term. Comm.	2-3	OPEN	2-1

() = Momentary

DPDT



SCHEMATIC



Model No.	POS 1	POS 2	POS 3
WDP-1	ON	NONE	ON
WDP-2	ON	NONE	(ON)
WDP-3	ON	OFF	ON
WDP-4	(ON)	OFF	(ON)
WDP-5	ON	OFF	(ON)
Term. Comm.	2-3, 5-6	OPEN	2-1, 5-4

() = Momentary

ACTUATOR OPTIONS

T1



T1 actuator std. when ordered with M1 termination.
Add 0.100 (2.54) for B4 bushing.

T2



T2 actuator std. when ordered with VS, M2, M6 or M7 terminations.
Add 0.100 (2.54) for B4 bushing.

BUSHING OPTIONS

B1



Std for M1

B4

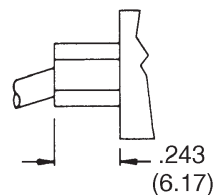

Std for M2, M6, M7, VS termination

SERIES 100A SWITCHES

TOGGLE SWITCHES - MINIATURE

TACT
SWITCHES

NAVIGATION
SWITCHES

PUSHBUTTON
SWITCHES

TOGGLE
SWITCHES

ROCKER
SWITCHES

SLIDE
SWITCHES

SNAP-ACTION
SWITCHES

DIP
SWITCHES

KEYLOCK
SWITCHES

ROTARY
SWITCHES

DETECTOR
SWITCHES

CAP
OPTIONS

TERMINATION OPTIONS

M1

SPDT



P.C. MOUNTING

M1

DPDT



P.C. MOUNTING

M2

SPDT



P.C. MOUNTING

M2

DPDT



P.C. MOUNTING



M6

SPDT



M6

DPDT

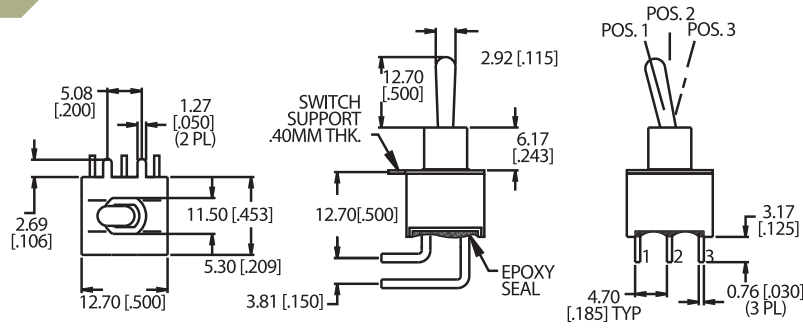
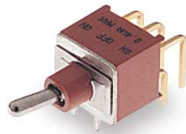

M7

SPDT

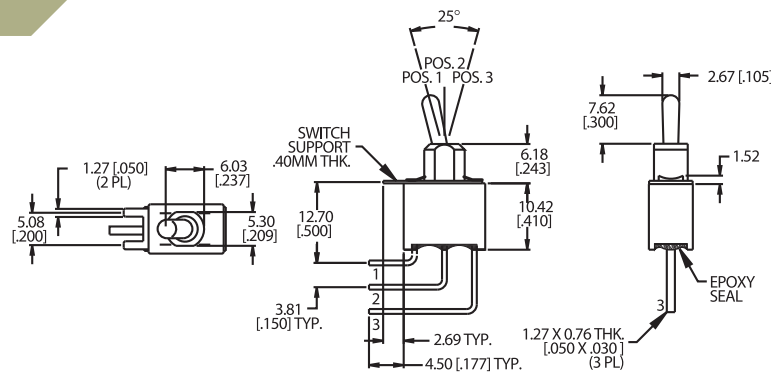
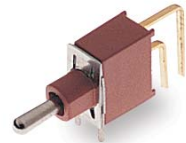

M7

DPDT

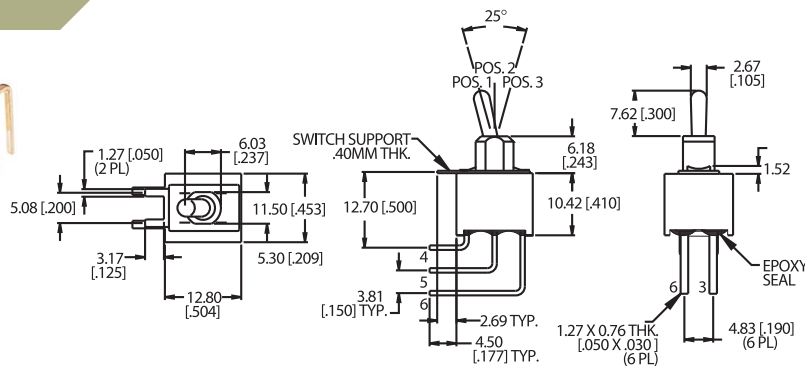

SERIES 100A SWITCHES

TOGGLE SWITCHES - MINIATURE

VS2-VS3

SPDT

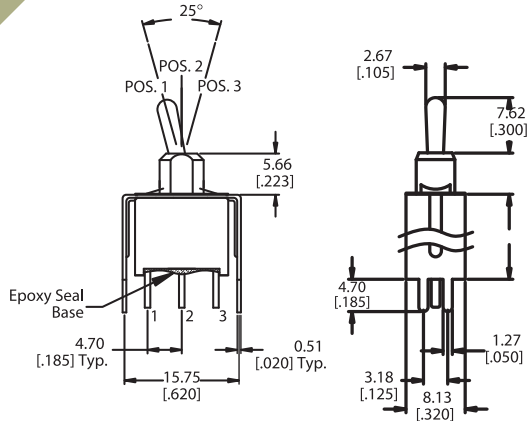

Option Code	Dim. 'A'
VS2	.460 (11.68)
VS3	.630 (16.00)

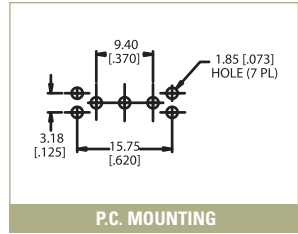

P.C. MOUNTING

VS2-VS3

DPDT

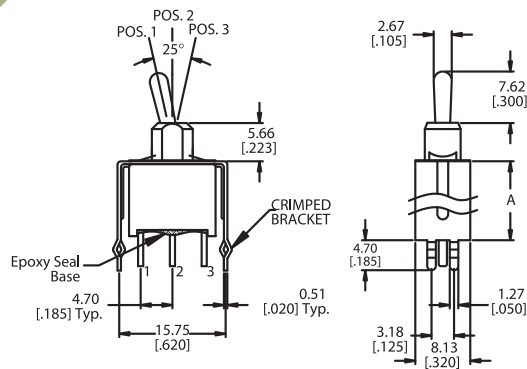

Option Code	Dim. 'A'
VS2	.460 (11.68)
VS3	.630 (16.00)

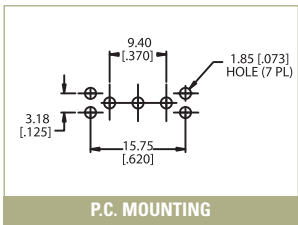

P.C. MOUNTING

CONTACT MATERIAL OPTIONS

Q

Fixed Terminal:	Gold flash over silver plated copper alloy
Moving Contact:	Silver plated copper alloy
Rating:	5 Amps with resistive load @ 120VAC or 28VDC; 2 Amps with resistive load @ 250VAC

R

Fixed Terminal:	Copper alloy with gold plate over nickel plate
Moving Contact:	Copper alloy with gold plate overnickel plate
Rating:	0.4 Volt-Amps (VA) max. @ 20V max. (AC or DC)

HARDWARE

HDW2 NUT

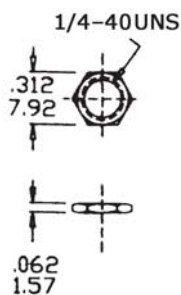

HDW15 LOCKING RING

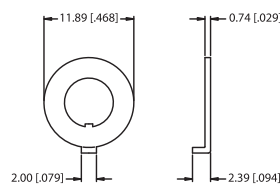

HDW11 LOCK WASHER

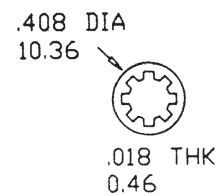



Компания «ЭлектроПласт» предлагает заключение долгосрочных отношений при поставках импортных электронных компонентов на взаимовыгодных условиях!

Наши преимущества:

- Оперативные поставки широкого спектра электронных компонентов отечественного и импортного производства напрямую от производителей и с крупнейших мировых складов;
- Поставка более 17-ти миллионов наименований электронных компонентов;
- Поставка сложных, дефицитных, либо снятых с производства позиций;
- Оперативные сроки поставки под заказ (от 5 рабочих дней);
- Экспресс доставка в любую точку России;
- Техническая поддержка проекта, помощь в подборе аналогов, поставка прототипов;
- Система менеджмента качества сертифицирована по Международному стандарту ISO 9001;
- Лицензия ФСБ на осуществление работ с использованием сведений, составляющих государственную тайну;
- Поставка специализированных компонентов (Xilinx, Altera, Analog Devices, Intersil, Interpoint, Microsemi, Aeroflex, Peregrine, Syfer, Eurofarad, Texas Instrument, Miteq, Cobham, E2V, MA-COM, Hittite, Mini-Circuits, General Dynamics и др.);

Помимо этого, одним из направлений компании «ЭлектроПласт» является направление «Источники питания». Мы предлагаем Вам помощь Конструкторского отдела:

- Подбор оптимального решения, техническое обоснование при выборе компонента;
- Подбор аналогов;
- Консультации по применению компонента;
- Поставка образцов и прототипов;
- Техническая поддержка проекта;
- Защита от снятия компонента с производства.



Как с нами связаться

Телефон: 8 (812) 309 58 32 (многоканальный)

Факс: 8 (812) 320-02-42

Электронная почта: org@eplast1.ru

Адрес: 198099, г. Санкт-Петербург, ул. Калинина, дом 2, корпус 4, литера А.