

SERIES 100A SWITCHES

TOGGLE SWITCHES - MINIATURE



FEATURES & BENEFITS

- ▶ Variety of switching functions
- ▶ Miniature
- ▶ Multiple actuator & bushing options
- ▶ Sealed to IP67

APPLICATIONS/MARKETS

- ▶ Telecommunications
- ▶ Instrumentation
- ▶ Networking
- ▶ Medical equipment

SPECIFICATIONS

| | |
|------------------------|--|
| Contact Rating: | Dependent upon contact material |
| Life Expectancy: | 30,000 make-and-break cycles at full load |
| Contact Resistance: | 10 mΩ max. typical initial @ 2-4 VDC 100 mA for both silver and gold plated contacts |
| Insulation Resistance: | 1,000 MΩ min. |
| Dielectric Strength: | 1,000 V RMS @ sea level |
| Operating Temperature: | -30° C to 85° C |

MATERIALS

| | |
|-----------------------|--|
| Case & Bushing: | PBT |
| Pedestal of Case: | LPC |
| Actuator: | Brass, chrome plated with internal O-ring seal |
| Switch Support: | Brass or steel tin plated |
| Contacts / Terminals: | Silver or gold plated copper alloy |

HOW TO ORDER

| SERIES | MODEL NO. | ACTUATOR | BUSHING | TERMINATION | CONTACT MATERIAL | SEAL | HARDWARE |
|--------|--|----------|----------|--|------------------------|---|--------------|
| 100A | □ □ □ □ | □ □ | □ □ | □ □ □ □ | □ | E | □ |
| | WSP1 WSP2 WSP3 WSP4 WSP5 WDP1 WDP2 WDP3 WDP4 WDP5 | T1 T2 | B1 B4 | M1 M2 M5 M6 M7 VS2 VS3 | Q = Silver R = Gold | E = Epoxy Sealed at Base of Terminal | H = Hardware |

Example Ordering Number

100A-WDP4-T1-B4-M1-R-E

Specifications subject to change without notice.

SPDT



| Model No. | POS 1 | POS 2 | POS 3 |
|-------------|-------|-------|-------|
| WSP-1 | ON | NONE | ON |
| WSP-2 | ON | NONE | (ON) |
| WSP-3 | ON | OFF | ON |
| WSP-4 | (ON) | OFF | (ON) |
| WSP-5 | ON | OFF | (ON) |
| Term. Comm. | 2-3 | OPEN | 2-1 |

() = Momentary

DPDT

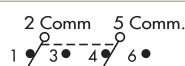

SCHEMATIC

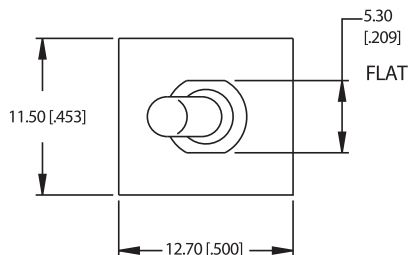

| Model No. | POS 1 | POS 2 | POS 3 |
|-------------|----------|-------|----------|
| WDP-1 | ON | NONE | ON |
| WDP-2 | ON | NONE | (ON) |
| WDP-3 | ON | OFF | ON |
| WDP-4 | (ON) | OFF | (ON) |
| WDP-5 | ON | OFF | (ON) |
| Term. Comm. | 2-3, 5-6 | OPEN | 2-1, 5-4 |

() = Momentary

ACTUATOR OPTIONS

T1

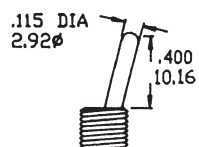

T1 actuator std. when ordered with M1 termination.
Add 0.100 (2.54) for B4 bushing.

T2



T2 actuator std. when ordered with VS, M2, M6 or M7 terminations.
Add 0.100 (2.54) for B4 bushing.

BUSHING OPTIONS

B1

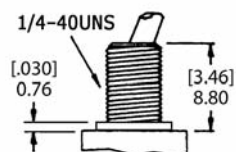

Std for M1

B4

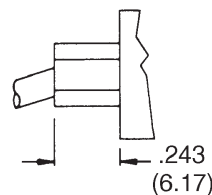

Std for M2, M6, M7, VS termination

SERIES 100A SWITCHES

TOGGLE SWITCHES - MINIATURE

TACT
SWITCHES

NAVIGATION
SWITCHES

PUSHBUTTON
SWITCHES

TOGGLE
SWITCHES

ROCKER
SWITCHES

SLIDE
SWITCHES

SNAP-ACTION
SWITCHES

DIP
SWITCHES

KEYLOCK
SWITCHES

ROTARY
SWITCHES

DETECTOR
SWITCHES

CAP
OPTIONS

TERMINATION OPTIONS

M1

SPDT

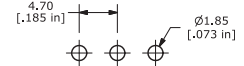
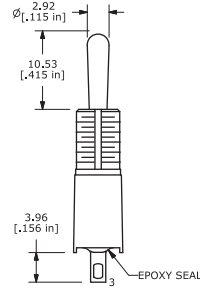
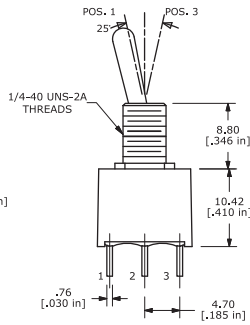
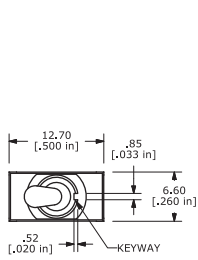

P.C. MOUNTING

M1

DPDT

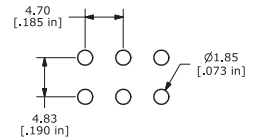
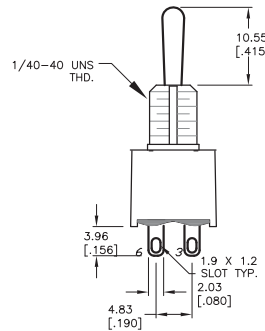
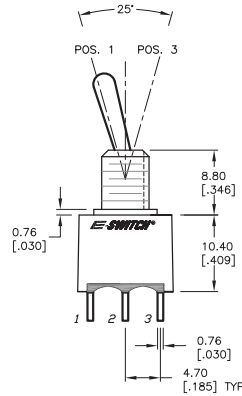
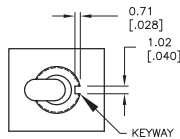

P.C. MOUNTING

M2

SPDT

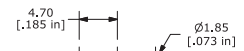
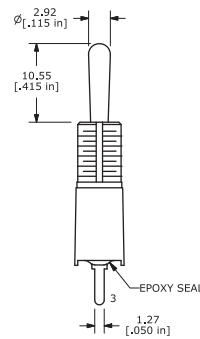
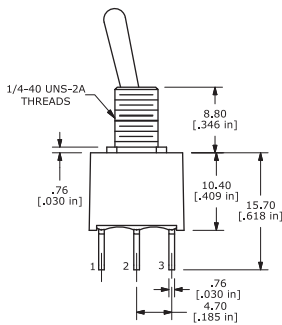
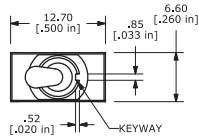

P.C. MOUNTING

M2

DPDT

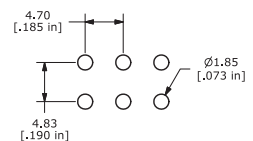
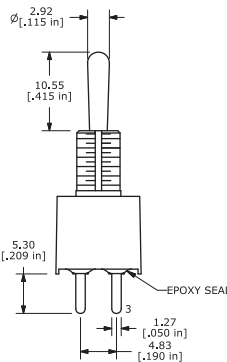
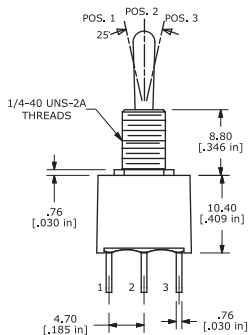
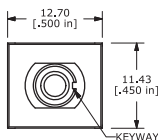

P.C. MOUNTING



M6

SPDT

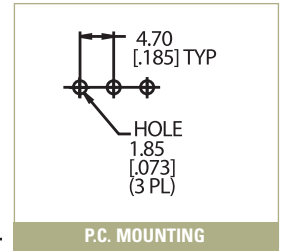
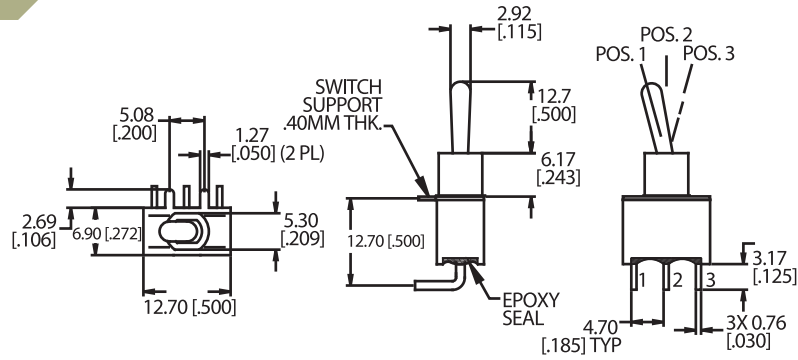

M6

DPDT

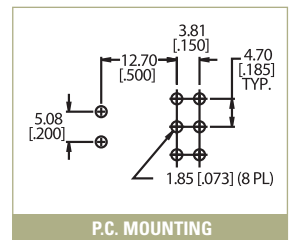
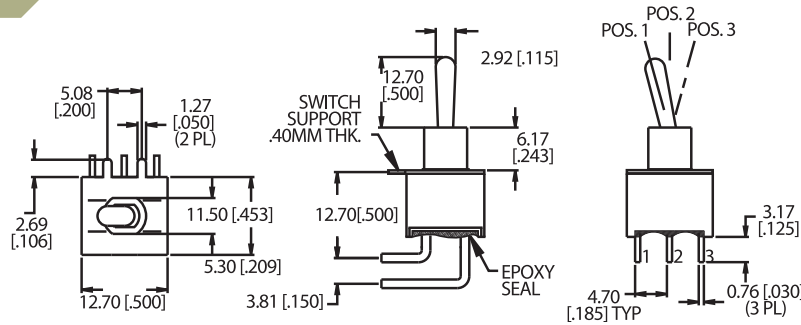
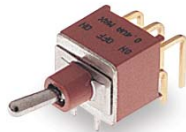

M7

SPDT

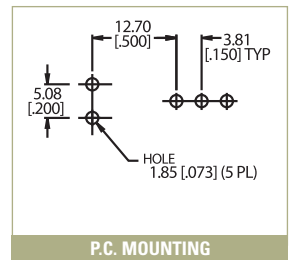
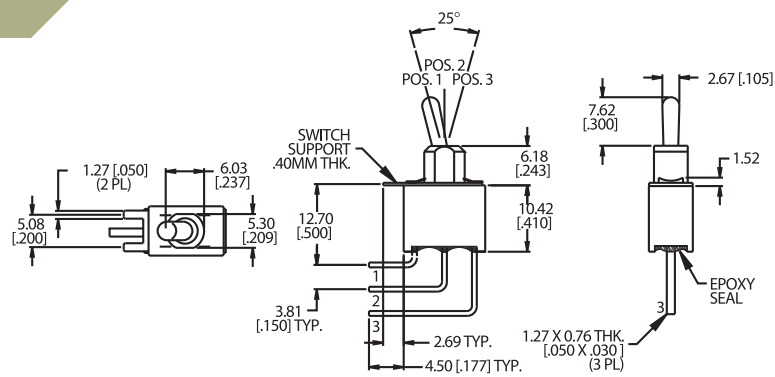
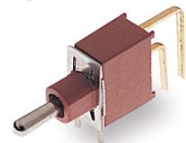

M7

DPDT

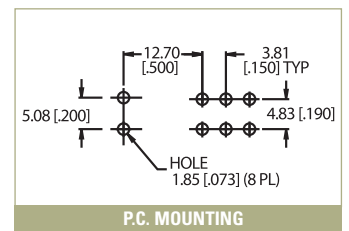
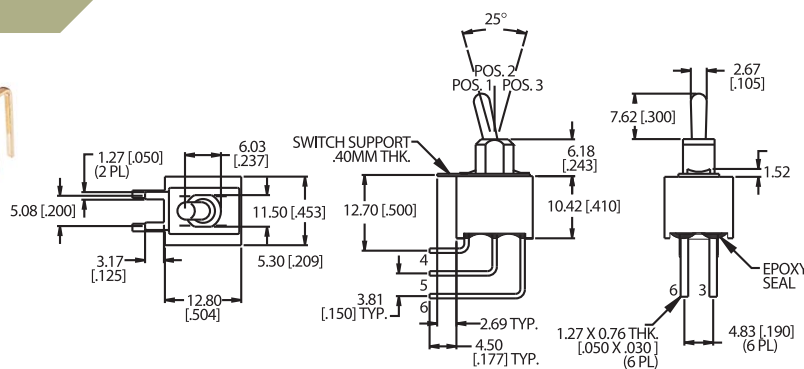

SERIES 100A SWITCHES

TOGGLE SWITCHES - MINIATURE

VS2-VS3

SPDT

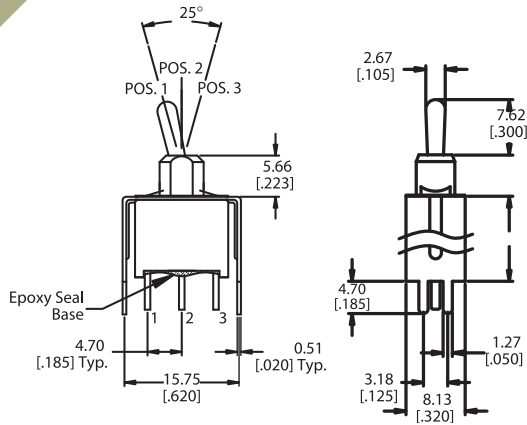

| Option Code | Dim. 'A' |
|-------------|--------------|
| VS2 | .460 (11.68) |
| VS3 | .630 (16.00) |

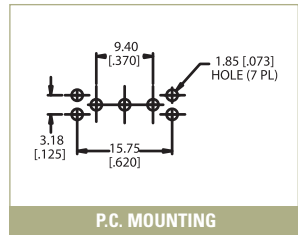

P.C. MOUNTING

VS2-VS3

DPDT

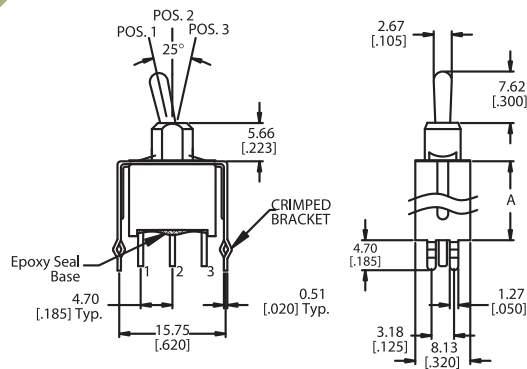

| Option Code | Dim. 'A' |
|-------------|--------------|
| VS2 | .460 (11.68) |
| VS3 | .630 (16.00) |

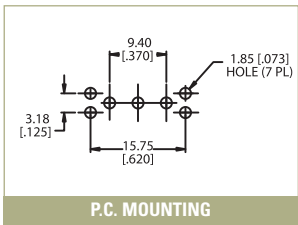

P.C. MOUNTING

CONTACT MATERIAL OPTIONS

Q

| | |
|-----------------|--|
| Fixed Terminal: | Gold flash over silver plated copper alloy |
| Moving Contact: | Silver plated copper alloy |
| Rating: | 5 Amps with resistive load @ 120VAC or 28VDC; 2 Amps with resistive load @ 250VAC |

R

| | |
|-----------------|--|
| Fixed Terminal: | Copper alloy with gold plate over nickel plate |
| Moving Contact: | Copper alloy with gold plate overnickel plate |
| Rating: | 0.4 Volt-Amps (VA) max. @ 20V max. (AC or DC) |

HARDWARE

HDW2 NUT

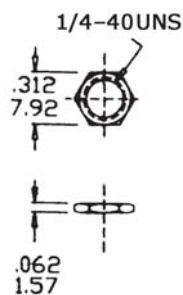

HDW15 LOCKING RING

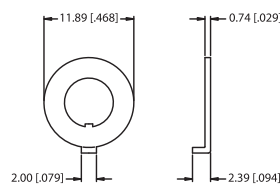

HDW11 LOCK WASHER

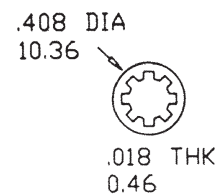



Компания «ЭлектроПласт» предлагает заключение долгосрочных отношений при поставках импортных электронных компонентов на взаимовыгодных условиях!

Наши преимущества:

- Оперативные поставки широкого спектра электронных компонентов отечественного и импортного производства напрямую от производителей и с крупнейших мировых складов;
- Поставка более 17-ти миллионов наименований электронных компонентов;
- Поставка сложных, дефицитных, либо снятых с производства позиций;
- Оперативные сроки поставки под заказ (от 5 рабочих дней);
- Экспресс доставка в любую точку России;
- Техническая поддержка проекта, помощь в подборе аналогов, поставка прототипов;
- Система менеджмента качества сертифицирована по Международному стандарту ISO 9001;
- Лицензия ФСБ на осуществление работ с использованием сведений, составляющих государственную тайну;
- Поставка специализированных компонентов (Xilinx, Altera, Analog Devices, Intersil, Interpoint, Microsemi, Aeroflex, Peregrine, Syfer, Eurofarad, Texas Instrument, Miteq, Cobham, E2V, MA-COM, Hittite, Mini-Circuits, General Dynamics и др.);

Помимо этого, одним из направлений компании «ЭлектроПласт» является направление «Источники питания». Мы предлагаем Вам помощь Конструкторского отдела:

- Подбор оптимального решения, техническое обоснование при выборе компонента;
- Подбор аналогов;
- Консультации по применению компонента;
- Поставка образцов и прототипов;
- Техническая поддержка проекта;
- Защита от снятия компонента с производства.



Как с нами связаться

Телефон: 8 (812) 309 58 32 (многоканальный)

Факс: 8 (812) 320-02-42

Электронная почта: org@eplast1.ru

Адрес: 198099, г. Санкт-Петербург, ул. Калинина, дом 2, корпус 4, литера А.