



■ Timing applications



■ Valves



■ HVAC



Microswitches

miniature

V3D

Microswitches miniature V3D

Crouzet Presentation

■ Adaptation	p. 3
■ Customisation is our business	p. 4
■ V3D Advantages	p. 5
■ Ordering information	p. 5
■ Basic technical principles	p. 5
■ Main specifications	p. 6
■ Additional specifications	p. 6
■ Principle	p. 7
■ Dimensions	p. 7
■ Product adaptations	p. 7
■ Connections	p. 8
■ Actuators	p. 9
■ Mounting-Operation	p. 9
■ Mechanical characteristics with actuators	p.10
■ Selection guide	p.11

Crouzet has been a recognised supplier of quality position sensors, micro-switches and limit switches for more than 30 years. Today, **Crouzet** offers you a new range of micro-switches designed to fulfill the toughest of OEMs' requirements.

To suit your design requirements, Crouzet continues to develop its capabilities as a specialist in customisation, offering you solutions specifically adapted to all your applications. Because our top most priority is nothing be left to chance, our quality and environmental management systems are certified to ISO 9001 and ISO 14001.

About Custom Sensors & Technologies



Headquartered in Moorpark, CA - Custom Sensors & Technologies (CST) is comprised of industry-leading brands including Crouzet, Kavlico, Crydom, and former divisions of BEI Technologies – Newall and Systron Donner. CST provides sensors, controls, and actuation products for the Transportation, Industrial and Aerospace & Defense markets.



Crouzet

Adaptation

To meet the growing demand for customisation, Crouzet's expertise in terms of adapting products and their corresponding accessories is available to all customers.

Crouzet can customise its products for use in any type of environment or application to ensure perfect integration into any equipment.

Because quality is at the heart of our approach, our quality control and environmental management system are certified to ISO 9001 and ISO 14001 respectively.

■ All our expertise in sensing design and industrialisation placed at your service, to respond to a **specific need** dedicated to your application.

■ A complete range of **standard microswitches** available immediately to create your sensing application.

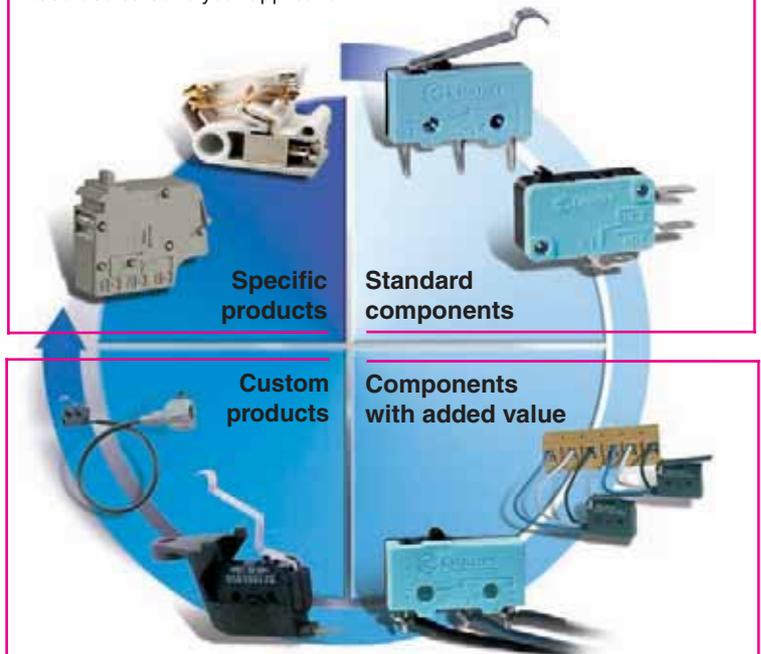

■ Defined in coordination with our technical sales teams, these **custom products** have the corresponding performance and functionality.

■ Standard products complemented by **factory-mounted auxiliaries or accessories** (levers, cables, connectors, etc) in order to assist integration in your equipment, simplify your logistics and maximise the reliability of your installation.

Crouzet

Process



■ Customer needs



■ R&D department



■ Production



■ Quality

Microswitches miniature V3D

Crouzet

Customisation is our business

□ Control devices

Even more adaptation for easier actuating

Special button shapes which compensate for any faults or positioning drift of the control actuator.



□ Connections

A complete electrical function

Special connectors, customised wiring, customer bundles, dedicated terminals...



□ Seals

Even more solutions for demanding environments

Numerous components available to provide effective protection for your contacts, including caps, boot seals, membranes, sealing resin, wiper seals.



□ Special levers

Obtain the control data

Angled, curved, extended or retractable... these special lever types can be used to extend the control device for easier adjustment, increase the operating force, resist high actuation torque or provide totally safe electrical isolation.



□ Special contacts

The right contact for every environment

High or low current, AC or DC, type of load (inductive or resistive), industrial or corrosive atmosphere, occasional or intensive use. The best metals, silver, silver nickel, silver palladium, gold-plated silver, solid gold.



□ Special fixings

No effort is spared to make mounting easier

Snap-on fixing, screw-fixing, crimping or pins are just a few examples of the numerous solutions available to meet all your requirements.



V3D Advantages

- Wide range of switching ratings from 0.1 A to 21 A
- V3 standard size
- Approved to ENEC (EN 61058-1) and UL/CSA
- Compliant to RoHS
- Glow wire test withstanding to EN 60335-1: GWFI 850°C and GWIT 775°C
- Various applications areas: Industry, Consumer equipment, Home appliances, HVAC, ...
- A high capacity to adapt levers, connections, fixing elements, upon request

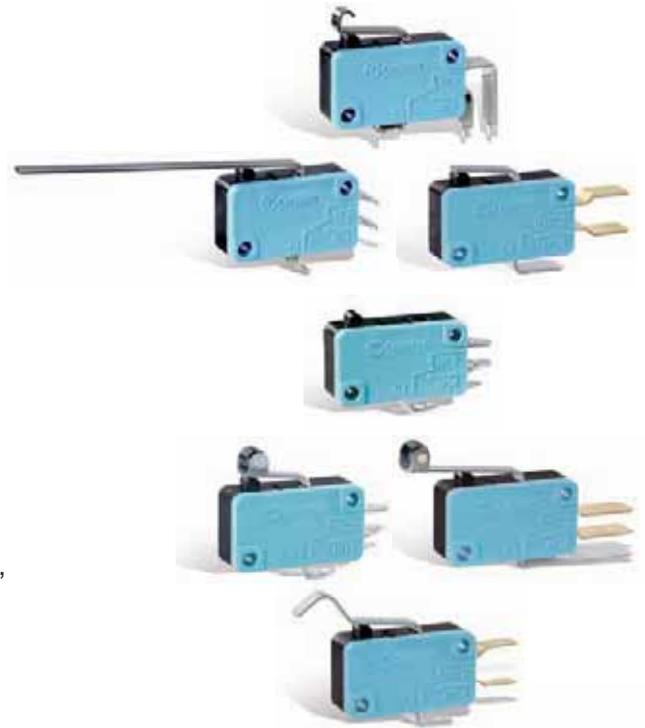

Ordering Information

Model Number Legend

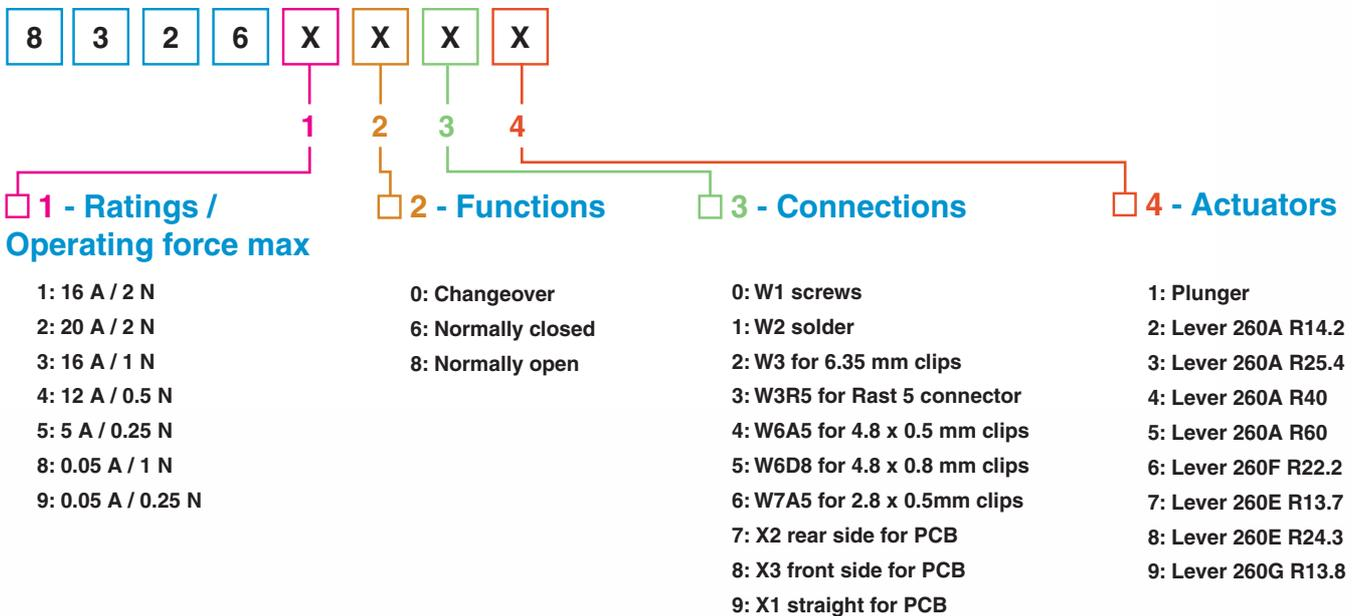

W3R2.5 for Rast 2.5 connector (SP9307): Contact us

Basic technical principles

- See our Position Sensors Catalogue

Microswitches miniature V3D

- Nominal ratings from 0.1 A to 21 A
- Operating temperature up to + 150°C
- Approved to ENEC and UL/CSA
- Large choice of actuators



Main specifications

		83261	83262	83263	83264
Function	Connections				
I (changeover)	W1 - W2 - W3 - W3R5 - W6A5 W6D8 - W7A5 - X1 - X2 - X3	●	●	●	●
R (normally closed)	W1 - W2 - W3 - W3R5 - W6A5 W6D8 - W7A5	●	●	●	●
C (normally open)	W1 - W2 - W3 - W3R5 - W6A5 W6D8 - W7A5	●	●	●	●
Electrical characteristics					
Rating nominal / 250 V AC (A)		16	20	16	12
Rating thermal / 250 V AC (A)		20	25	20	15
Rating nominal / 5 → 24 V AC/DC (A)		-	-	-	-
Mechanical characteristics					
Maximum operating force (N)		2	2	1	0.5
Min. Release force (N)		0.5	0.5	0.2	0.1
Maximum total travel force (N)		3	3	1.5	0.8
Max. permitted overtravel force (N)		20	20	20	20
Maximum rest position (mm)		16.2	16.2	16.2	16.2
Tripping point (mm)		14.7 ^{+0.5}	14.7 ^{+0.5}	14.7 ^{+0.5}	14.7 ^{+0.5}
Maximum differential travel (mm)		0.40	0.40	0.40	0.40
Min. overtravel (mm)		1.1	1.1	1.1	1.1
Ambient operating temperature (°C)		-20 → +125	-20 → +125	-20 → +125	-20 → +125
Mechanical life for 2/3 OT (operations)		1 000 000	1 000 000	1 000 000	1 000 000
Contact gap (mm)		0.6	0.6	0.6	0.6
Weight (g)		6	6	6	6
Approvals					
EN 61058-1	Rating for T125°C ** T150°C *** T85°C	16 (4) A 250 V AC	20 (8) A 250 V AC	16 (4) A 250 V AC	***12 (6) A 250 V AC
	Number of cycles	50 000	10 000	50 000	50 000
UL 1054	Rating	16 A 125 / 250 V AC	21 A 125 / 250 V AC 1/2 HP 125 V AC 1 HP 250 V AC	16 A 125 / 250 V AC	8 A 1/4 HP 125 / 250 V AC
	Number of cycles	6 000	6 000	6 000	6 000

Additional specifications

Component Materials

- Housing/cover/button: polyester UL 94V0 - GWIT 775°C / GWFI 850°C
- Blade/spring: copper alloy
- Contacts: silver alloy or gold plated
- Terminals: brass or silver plated brass
- Actuators: stainless steel, glass filled polyamide roller



83265	83268	83269
●	●	●
●	●	●
●	●	●
5	-	-
7.5	-	-
-	0.001 → 0.05	0.001 → 0.05
0.25	1	0.25
0.05	0.2	0.05
0.4	1.5	0.4
20	20	20
16.2	16.2	16.2
14.7 ^{±0.5}	14.7 ^{±0.5}	14.7 ^{±0.5}
0.40	0.40	0.40
1.1	1.1	1.1
-20 → +125	-20 → +150	-20 → +150
1 000 000	1 000 000	1 000 000
0.6	0.6	0.6
6	6	6
** 5 (1) A 250 V AC	** 0.1 (0.04) A 250 V AC	** 0.1 (0.04) A 250 V AC
50 000	50 000	50 000
5 A 1/10 HP 125 / 250 V AC	0.1 A 125 V AC 0.1 A 30 V DC	0.1 A 125 V AC 0.1 A 30 V DC
6 000	6 000	6 000

Principle

Single break changeover switch

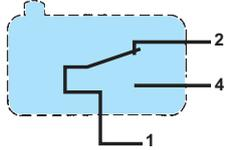

Dimensions (mm)

V3D

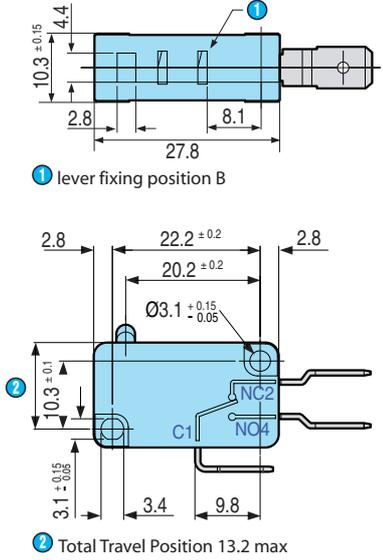

Product adaptations

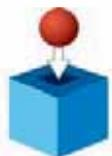

- Rast 2.5 connection (SP9307): see [Connections](#)
- Other specific connections
- Specific levers
- Specific contacts
- Specific fixing
- High operating temperature

Microswitches miniature V3D

Connections

W1

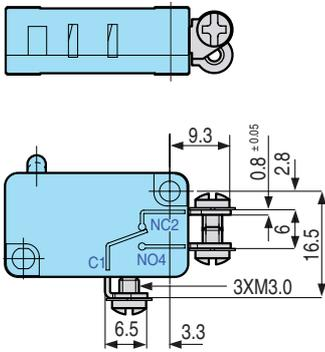

W2

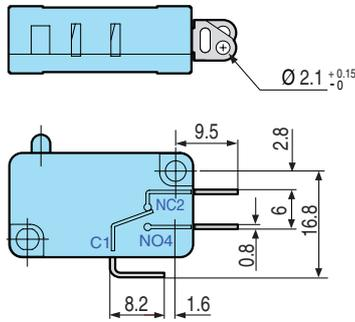

W3

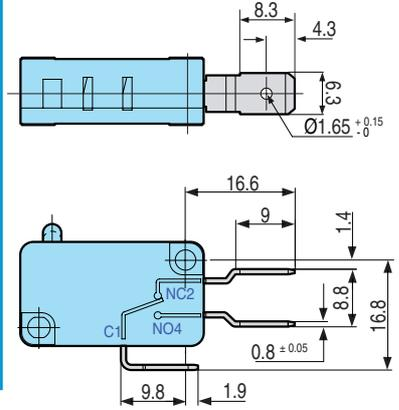

W3R5

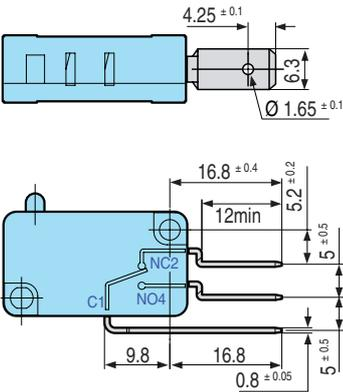

W6A5

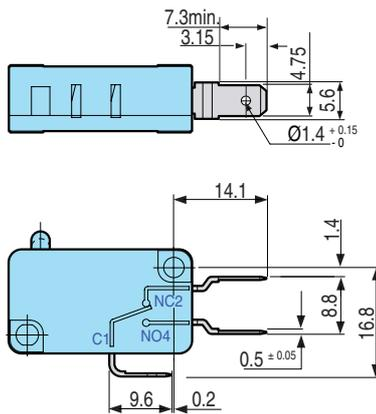

W6D8

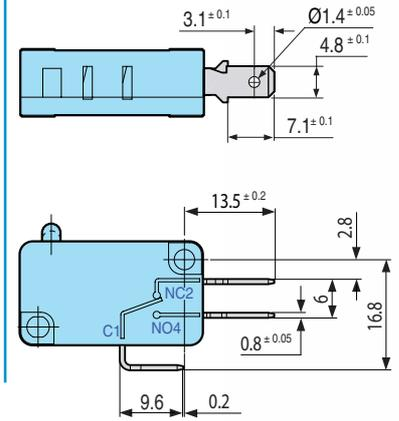

W7A5

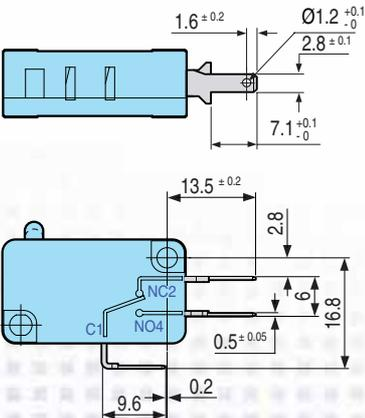

X1

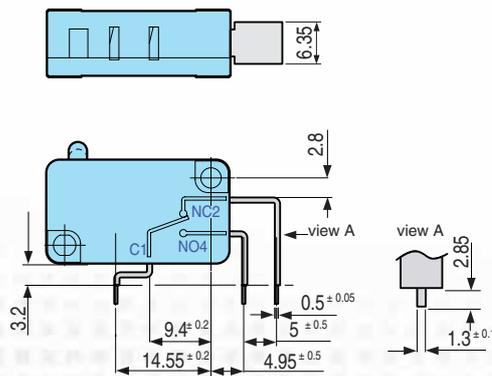

X2

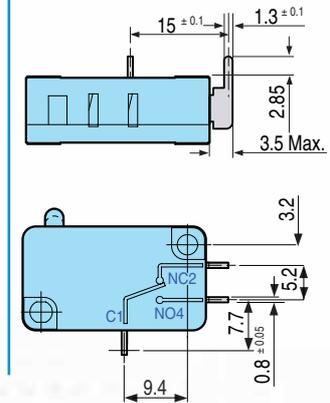

X3

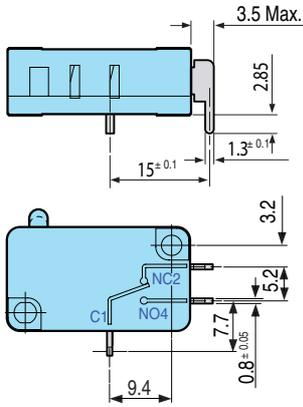

W3R2.5 (SP9307)

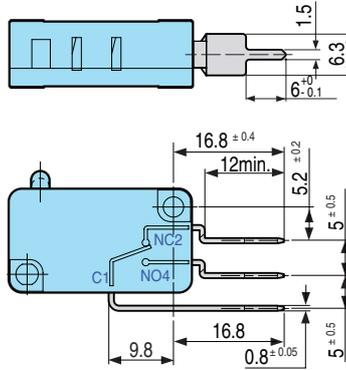

Contact us

Actuators

260 A

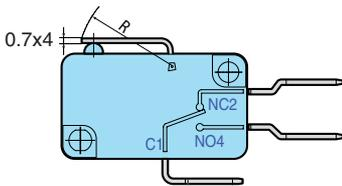

260 E

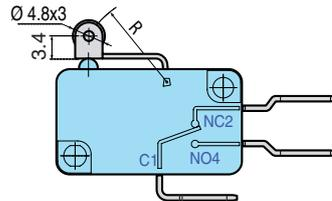

260 F

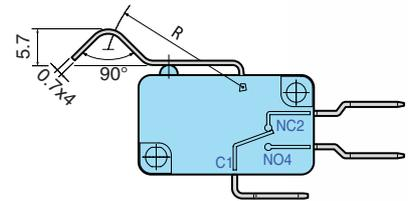

260 G

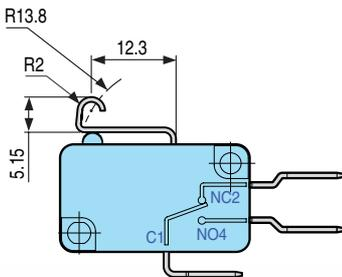

Actuator mounting position

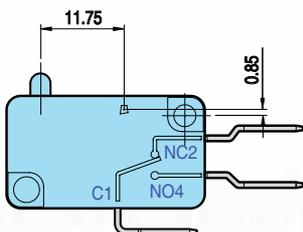

Mounting - Operation

To conform to the leakage paths and air gaps required in the standard EN/IEC 61058-1 - EN/IEC 60947-5-1:

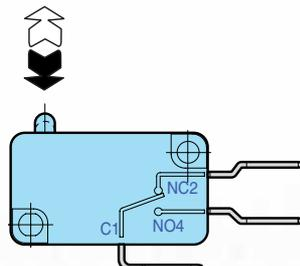

■ An insulation pad must be inserted between the microswitch and the fixing surface if the fixing surface is metal.

■ Manual operation of a metal actuator must only be carried out with the help of a secondary actuator made of insulating material. The installer must ensure adequate protection against direct contact with the output terminals.

Microswitches miniature V3D

Mechanical characteristics with actuators

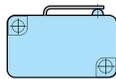
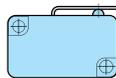
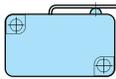
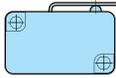
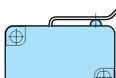
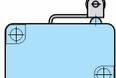
		Length of actuator (mm)	Maximum operating force (N)	Minimum release force (N)	Tripping point (mm)	Minimum overtravel (mm)	Maximum differential travel (mm)	Maximum total travel (mm)
 <p>Lever 260A R14.2 Pos B</p>	83261	14.2	2	0.5	15.4 \pm 0.5	1.1	0.4	3
	83262	14.2	2	0.5	15.4 \pm 0.5	1.1	0.4	3
	83263	14.2	1	0.2	15.4 \pm 0.5	1.1	0.4	3
	83264	14.2	0.5	0.1	15.4 \pm 0.5	1.1	0.4	3
	83265	14.2	0.25	0.05	15.4 \pm 0.5	1.1	0.4	3
	83268	14.2	1	0.2	15.4 \pm 0.5	1.1	0.4	3
	83269	14.2	0.25	0.05	15.4 \pm 0.5	1.1	0.4	3
 <p>Lever 260A R25.4 Pos B</p>	83261	25.4	1	0.25	15.4 \pm 1	2	0.8	5.8
	83262	25.4	1	0.25	15.4 \pm 1	2	0.8	5.8
	83263	25.4	0.5	0.1	15.4 \pm 1	2	0.8	5.8
	83264	25.4	0.25	0.05	15.4 \pm 1	2	0.8	5.8
	83265	25.4	0.13	0.02	15.4 \pm 1	2	0.8	5.8
	83268	25.4	0.5	0.1	15.4 \pm 1	2	0.8	5.8
	83269	25.4	0.13	0.02	15.4 \pm 1	2	0.8	5.8
 <p>Lever 260A R40 Pos B</p>	83261	40	0.6	0.15	15.4 \pm 1.8	3.3	1.3	9.6
	83262	40	0.6	0.15	15.4 \pm 1.8	3.3	1.3	9.6
	83263	40	0.3	0.06	15.4 \pm 1.8	3.3	1.3	9.6
	83264	40	0.15	0.03	15.4 \pm 1.8	3.3	1.3	9.6
	83265	40	0.08	0.01	15.4 \pm 1.8	3.3	1.3	9.6
	83268	40	0.3	0.06	15.4 \pm 1.8	3.3	1.3	9.6
	83269	40	0.08	0.01	15.4 \pm 1.8	3.3	1.3	9.6
 <p>Lever 260A R60 Pos B</p>	83261	60	0.4	0.1	15.4 \pm 2.5	5	2	14.5
	83262	60	0.4	0.1	15.4 \pm 2.5	5	2	14.5
	83263	60	0.2	0.04	15.4 \pm 2.5	5	2	14.5
	83264	60	0.1	0.02	15.4 \pm 2.5	5	2	14.5
	83265	60	0.05	0.01	15.4 \pm 2.5	5	2	14.5
	83268	60	0.2	0.04	15.4 \pm 2.5	5	2	14.5
	83269	60	0.05	0.01	15.4 \pm 1	5	2	14.5
 <p>Lever 260F R22.2 Pos B</p>	83261	22.2	1.06	0.26	20.4 \pm 1	1.8	0.75	5.2
	83262	22.2	1.06	0.26	20.4 \pm 1	1.8	0.75	5.2
	83263	22.2	0.53	0.1	20.4 \pm 1	1.8	0.75	5.2
	83264	22.2	0.27	0.05	20.4 \pm 1	1.8	0.75	5.2
	83265	22.2	0.13	0.02	20.4 \pm 1	1.8	0.75	5.2
	83268	22.2	0.53	0.1	20.4 \pm 1	1.8	0.75	5.2
	83269	22.2	0.13	0.02	20.4 \pm 1	1.8	0.75	5.2
 <p>Lever 260E R13.7 Pos B</p>	83261	13.7	2	0.5	20.5 \pm 0.8	1.1	0.4	3
	83262	13.7	2	0.5	20.5 \pm 0.8	1.1	0.4	3
	83263	13.7	1	0.2	20.5 \pm 0.8	1.1	0.4	3
	83264	13.7	0.5	0.1	20.5 \pm 0.8	1.1	0.4	3
	83265	13.7	0.25	0.05	20.5 \pm 0.8	1.1	0.4	3
	83268	13.7	1	0.2	20.5 \pm 0.8	1.1	0.4	3
	83269	13.7	0.25	0.05	20.5 \pm 0.8	1.1	0.4	3

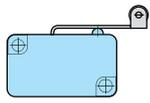

Lever 260E
R24.3 Pos B

		Length of actuator (mm)	Maximum operating force (N)	Minimum release force (N)	Tripping point (mm)	Minimum overtravel (mm)	Maximum differential travel (mm)	Maximum total travel (mm)
83261	24.3	1	0.25	20.5 ^{+1.5}	2	0.8	5.8	
83262	24.3	1	0.25	20.5 ^{+1.5}	2	0.8	5.8	
83263	24.3	0.5	0.1	20.5 ^{+1.5}	2	0.8	5.8	
83264	24.3	0.25	0.05	20.5 ^{+1.5}	2	0.8	5.8	
83265	24.3	0.13	0.02	20.5 ^{+1.5}	2	0.8	5.8	
83268	24.3	0.5	0.1	20.5 ^{+1.5}	2	0.8	5.8	
83269	24.3	0.13	0.02	20.5 ^{+1.5}	2	0.8	5.8	

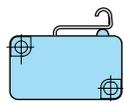

Lever 260G
R13.8 Pos B

83261	13.8	2	0.5	19.9 ^{+0.7}	1.1	0.4	3
83262	13.8	2	0.5	19.9 ^{+0.7}	1.1	0.4	3
83263	13.8	1	0.2	19.9 ^{+0.7}	1.1	0.4	3
83264	13.8	0.5	0.1	19.9 ^{+0.7}	1.1	0.4	3
83265	13.8	0.25	0.05	19.9 ^{+0.7}	1.1	0.4	3
83268	13.8	1	0.2	19.9 ^{+0.7}	1.1	0.4	3
83269	13.8	0.25	0.05	19.9 ^{+0.7}	1.1	0.4	3

Selection guide

		Rating / Force		16 A / 2 N	20 A / 2 N	16 A / 1 N	12 A / 0.5 N	5 A / 0.25 N	0.05 A / 1 N	0.05 A / 0.25 N
		Type		83261	83262	83263	83264	83265	83268	83269
Actuators	Function	Connection								
	I	W1	83261001	83262001	83263001	83264001	83265001	83268001	83269001	
	I	W2	83261011	83262011	83263011	83264011	83265011	83268011	83269011	
	I	W3	83261021	83262021	83263021	83264021	83265021	83268021	83269021	
	I	W3R5	83261031	83262031	83263031	83264031	83265031	83268031	83269031	
	I	W6A5	83261041	83262041	83263041	83264041	83265041	83268041	83269041	
	I	W6D8	83261051	83262051	83263051	83264051	83265051	83268051	83269051	
	I	W7A5	83261061	-	83263061	83264061	83265061	83268061	83269061	
	I	X2	83261071	-	83263071	83264071	83265071	83268071	83269071	
	I	X3	83261081	-	83263081	83264081	83265081	83268081	83269081	
	I	X1	83261091	-	83263091	83264091	83265091	83268091	83269091	
	R	W1	83261601	83262601	83263601	83264601	83265601	83268601	83269601	
	R	W2	83261611	83262611	83263611	83264611	83265611	83268611	83269611	
	R	W3	83261621	83262621	83263621	83264621	83265621	83268621	83269621	
	R	W3R5	83261631	83262631	83263631	83264631	83265631	83268631	83269631	
	R	W6A5	83261641	83262641	83263641	83264641	83265641	83268641	83269641	
	R	W6D8	83261651	83262651	83263651	83264651	83265651	83268651	83269651	
	R	W7A5	83261661	-	83263661	83264661	83265661	83268661	83269661	
	C	W1	83261801	83262801	83263801	83264801	83265801	83268801	83269801	
	C	W2	83261811	83262811	83263811	83264811	83265811	83268811	83269811	
	C	W3	83261821	83262821	83263821	83264821	83265821	83268821	83269821	
C	W3R5	83261831	83262831	83263831	83264831	83265831	83268831	83269831		
C	W6A5	83261841	83262841	83263841	83264841	83265841	83268841	83269841		
C	W6D8	83261851	83262851	83263851	83264851	83265851	83268851	83269851		
C	W7A5	83261861	-	83263861	83264861	83265861	83268861	83269861		

Microswitches miniature V3D

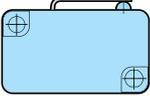
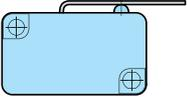
		Rating / Force	16 A / 2 N	20 A / 2 N	16 A / 1 N	12 A / 0.5 N	5 A / 0.25 N	0.05 A / 1 N	0.05 A / 0.25 N
		Type	83261	83262	83263	83264	83265	83268	83269
Actuators	Function	Connection							
 <p>Lever 260A R14.2 Pos B</p>	I	W1	83261002	83262002	83263002	83264002	83265002	83268002	83269002
	I	W2	83261012	83262012	83263012	83264012	83265012	83268012	83269012
	I	W3	83261022	83262022	83263022	83264022	83265022	83268022	83269022
	I	W3R5	83261032	83262032	83263032	83264032	83265032	83268032	83269032
	I	W6A5	83261042	83262042	83263042	83264042	83265042	83268042	83269042
	I	W6D8	83261052	83262052	83263052	83264052	83265052	83268052	83269052
	I	W7A5	83261062	-	83263062	83264062	83265062	83268062	83269062
	I	X2	83261072	-	83263072	83264072	83265072	83268072	83269072
	I	X3	83261082	-	83263082	83264082	83265082	83268082	83269082
	I	X1	83261092	-	83263092	83264092	83265092	83268092	83269092
	R	W1	83261602	83262602	83263602	83264602	83265602	83268602	83269602
	R	W2	83261612	83262612	83263612	83264612	83265612	83268612	83269612
	R	W3	83261622	83262622	83263622	83264622	83265622	83268622	83269622
	R	W3R5	83261632	83262632	83263632	83264632	83265632	83268632	83269632
	R	W6A5	83261642	83262642	83263642	83264642	83265642	83268642	83269642
	R	W6D8	83261652	83262652	83263652	83264652	83265652	83268652	83269652
	R	W7A5	83261662	-	83263662	83264662	83265662	83268662	83269662
	C	W1	83261802	83262802	83263802	83264802	83265802	83268802	83269802
	C	W2	83261812	83262812	83263812	83264812	83265812	83268812	83269812
C	W3	83261822	83262822	83263822	83264822	83265822	83268822	83269822	
C	W3R5	83261832	83262832	83263832	83264832	83265832	83268832	83269832	
C	W6A5	83261842	83262842	83263842	83264842	83265842	83268842	83269842	
C	W6D8	83261852	83262852	83263852	83264852	83265852	83268852	83269852	
C	W7A5	83261862	-	83263862	83264862	83265862	83268862	83269862	
 <p>Lever 260A R25.4 Pos B</p>	I	W1	83261003	83262003	83263003	83264003	83265003	83268003	83269003
	I	W2	83261013	83262013	83263013	83264013	83265013	83268013	83269013
	I	W3	83261023	83262023	83263023	83264023	83265023	83268023	83269023
	I	W3R5	83261033	83262033	83263033	83264033	83265033	83268033	83269033
	I	W6A5	83261043	83262043	83263043	83264043	83265043	83268043	83269043
	I	W6D8	83261053	83262053	83263053	83264053	83265053	83268053	83269053
	I	W7A5	83261063	-	83263063	83264063	83265063	83268063	83269063
	I	X2	83261073	-	83263073	83264073	83265073	83268073	83269073
	I	X3	83261083	-	83263083	83264083	83265083	83268083	83269083
	I	X1	83261093	-	83263093	83264093	83265093	83268093	83269093
	R	W1	83261603	83262603	83263603	83264603	83265603	83268603	83269603
	R	W2	83261613	83262613	83263613	83264613	83265613	83268613	83269613
	R	W3	83261623	83262623	83263623	83264623	83265623	83268623	83269623
	R	W3R5	83261633	83262633	83263633	83264633	83265633	83268633	83269633
	R	W6A5	83261643	83262643	83263643	83264643	83265643	83268643	83269643
	R	W6D8	83261653	83262653	83263653	83264653	83265653	83268653	83269653
	R	W7A5	83261663	-	83263663	83264663	83265663	83268663	83269663
	C	W1	83261803	83262803	83263803	83264803	83265803	83268803	83269803
	C	W2	83261813	83262813	83263813	83264813	83265813	83268813	83269813
	C	W3	83261823	83262823	83263823	83264823	83265823	83268823	83269823
	C	W3R5	83261833	83262833	83263833	83264833	83265833	83268833	83269833
	C	W6A5	83261843	83262843	83263843	83264843	83265843	83268843	83269843
	C	W6D8	83261853	83262853	83263853	83264853	83265853	83268853	83269853
	C	W7A5	83261863	-	83263863	83264863	83265863	83268863	83269863

Note:

Function: **I** = Changeover - **R** = Normally closed - **C** = Normally open
 Connection: **W1** = screws - **W2** = solder - **W3** = for 6.35 mm clips - **W3R5** = for Rast 5 connector
W6A5 = for 4.8 x 0.5 mm clips - **W6D8** = for 4.8 x 0.8 mm clips - **W7A5** = for 2.8 x 0.5 mm clips
X2 = rear side for PCB - **X3** = front side for PCB - **X1** = straight for PCB

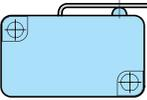
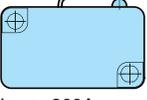
		Rating / Force	16 A / 2 N	20 A / 2 N	16 A / 1 N	12 A / 0.5N	5 A / 0.25 N	0.05 A / 1 N	0.05 A / 0.25 N
		Type	83261	83262	83263	83264	83265	83268	83269
Actuators	Function	Connection							
 Lever 260A R40 Pos B	I	W1	83261004	83262004	83263004	83264004	83265004	83268004	83269004
	I	W2	83261014	83262014	83263014	83264014	83265014	83268014	83269014
	I	W3	83261024	83262024	83263024	83264024	83265024	83268024	83269024
	I	W3R5	83261034	83262034	83263034	83264034	83265034	83268034	83269034
	I	W6A5	83261044	83262044	83263044	83264044	83265044	83268044	83269044
	I	W6D8	83261054	83262054	83263054	83264054	83265054	83268054	83269054
	I	W7A5	83261064	-	83263064	83264064	83265064	83268064	83269064
	I	X2	83261074	-	83263074	83264074	83265074	83268074	83269074
	I	X3	83261084	-	83263084	83264084	83265084	83268084	83269084
	I	X1	83261094	-	83263094	83264094	83265094	83268094	83269094
 Lever 260A R60 Pos B	R	W1	83261604	83262604	83263604	83264604	83265604	83268604	83269604
	R	W2	83261614	83262614	83263614	83264614	83265614	83268614	83269614
	R	W3	83261624	83262624	83263624	83264624	83265624	83268624	83269624
	R	W3R5	83261634	83262634	83263634	83264634	83265634	83268634	83269634
	R	W6A5	83261644	83262644	83263644	83264644	83265644	83268644	83269644
	R	W6D8	83261654	83262654	83263654	83264654	83265654	83268654	83269654
	R	W7A5	83261664	-	83263664	83264664	83265664	83268664	83269664
	C	W1	83261804	83262804	83263804	83264804	83265804	83268804	83269804
	C	W2	83261814	83262814	83263814	83264814	83265814	83268814	83269814
	C	W3	83261824	83262824	83263824	83264824	83265824	83268824	83269824
	C	W3R5	83261834	83262834	83263834	83264834	83265834	83268834	83269834
	C	W6A5	83261844	83262844	83263844	83264844	83265844	83268844	83269844
	C	W6D8	83261854	83262854	83263854	83264854	83265854	83268854	83269854
	C	W7A5	83261864	-	83263864	83264864	83265864	83268864	83269864
	I	W1	83261005	83262005	83263005	83264005	83265005	83268005	83269005
	I	W2	83261015	83262015	83263015	83264015	83265015	83268015	83269015
	I	W3	83261025	83262025	83263025	83264025	83265025	83268025	83269025
	I	W3R5	83261035	83262035	83263035	83264035	83265035	83268035	83269035
	I	W6A5	83261045	83262045	83263045	83264045	83265045	83268045	83269045
	I	W6D8	83261055	83262055	83263055	83264055	83265055	83268055	83269055
	I	W7A5	83261065	-	83263065	83264065	83265065	83268065	83269065
	I	X2	83261075	-	83263075	83264075	83265075	83268075	83269075
	I	X3	83261085	-	83263085	83264085	83265085	83268085	83269085
	I	X1	83261095	-	83263095	83264095	83265095	83268095	83269095
	R	W1	83261605	83262605	83263605	83264605	83265605	83268605	83269605
	R	W2	83261615	83262615	83263615	83264615	83265615	83268615	83269615
	R	W3	83261625	83262625	83263625	83264625	83265625	83268625	83269625
	R	W3R5	83261635	83262635	83263635	83264635	83265635	83268635	83269635
	R	W6A5	83261645	83262645	83263645	83264645	83265645	83268645	83269645
	R	W6D8	83261655	83262655	83263655	83264655	83265655	83268655	83269655
R	W7A5	83261665	-	83263665	83264665	83265665	83268665	83269665	
	C	W1	83261805	83262805	83263805	83264805	83265805	83268805	83269805
	C	W2	83261815	83262815	83263815	83264815	83265815	83268815	83269815
	C	W3	83261825	83262825	83263825	83264825	83265825	83268825	83269825
	C	W3R5	83261835	83262835	83263835	83264835	83265835	83268835	83269835
	C	W6A5	83261845	83262845	83263845	83264845	83265845	83268845	83269845
	C	W6D8	83261855	83262855	83263855	83264855	83265855	83268855	83269855
	C	W7A5	83261865	-	83263865	83264865	83265865	83268865	83269865

Note:

Function: **I** = Changeover - **R** = Normally closed - **C** = Normally open

Connection: **W1** = screws - **W2** = solder - **W3** = for 6.35 mm clips - **W3R5** = for Rast 5 connector

W6A5 = for 4.8 x 0.5 mm clips - **W6D8** = for 4.8 x 0.8 mm clips - **W7A5** = for 2.8 x 0.5 mm clips

X2 = rear side for PCB - **X3** = front side for PCB - **X1** = straight for PCB

Microswitches miniature V3D

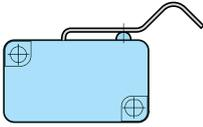
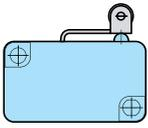
		Rating / Force		16 A / 2 N	20 A / 2 N	16 A / 1 N	12 A / 0.5 N	5 A / 0.25 N	0.05 A / 1 N	0.05 A / 0.25 N	
		Type		83261	83262	83263	83264	83265	83268	83269	
Actuators	Function	Connection									
 <p>Lever 260F R22.2 Pos B</p>	I	W1	83261006	83262006	83263006	83264006	83265006	83268006	83269006		
	I	W2	83261016	83262016	83263016	83264016	83265016	83268016	83269016		
	I	W3	83261026	83262026	83263026	83264026	83265026	83268026	83269026		
	I	W3R5	83261036	83262036	83263036	83264036	83265036	83268036	83269036		
	I	W6A5	83261046	83262046	83263046	83264046	83265046	83268046	83269046		
	I	W6D8	83261056	83262056	83263056	83264056	83265056	83268056	83269056		
	I	W7A5	83261066	-	83263066	83264066	83265066	83268066	83269066		
	I	X2	83261076	-	83263076	83264076	83265076	83268076	83269076		
	I	X3	83261086	-	83263086	83264086	83265086	83268086	83269086		
	I	X1	83261096	-	83263096	83264096	83265096	83268096	83269096		
	R	W1	83261606	83262606	83263606	83264606	83265606	83268606	83269606		
	R	W2	83261616	83262616	83263616	83264616	83265616	83268616	83269616		
	R	W3	83261626	83262626	83263626	83264626	83265626	83268626	83269626		
	R	W3R5	83261636	83262636	83263636	83264636	83265636	83268636	83269636		
	R	W6A5	83261646	83262646	83263646	83264646	83265646	83268646	83269646		
	R	W6D8	83261656	83262656	83263656	83264656	83265656	83268656	83269656		
	R	W7A5	83261666	-	83263666	83264666	83265666	83268666	83269666		
	C	W1	83261806	83262806	83263806	83264806	83265806	83268806	83269806		
	C	W2	83261816	83262816	83263816	83264816	83265816	83268816	83269816		
C	W3	83261826	83262826	83263826	83264826	83265826	83268826	83269826			
C	W3R5	83261836	83262836	83263836	83264836	83265836	83268836	83269836			
C	W6A5	83261846	83262846	83263846	83264846	83265846	83268846	83269846			
C	W6D8	83261856	83262856	83263856	83264856	83265856	83268856	83269856			
C	W7A5	83261866	-	83263866	83264866	83265866	83268866	83269866			
 <p>Lever 260E R13.7 Pos B</p>	I	W1	83261007	83262007	83263007	83264007	83265007	83268007	83269007		
	I	W2	83261017	83262017	83263017	83264017	83265017	83268017	83269017		
	I	W3	83261027	83262027	83263027	83264027	83265027	83268027	83269027		
	I	W3R5	83261037	83262037	83263037	83264037	83265037	83268037	83269037		
	I	W6A5	83261047	83262047	83263047	83264047	83265047	83268047	83269047		
	I	W6D8	83261057	83262057	83263057	83264057	83265057	83268057	83269057		
	I	W7A5	83261067	-	83263067	83264067	83265067	83268067	83269067		
	I	X2	83261077	-	83263077	83264077	83265077	83268077	83269077		
	I	X3	83261087	-	83263087	83264087	83265087	83268087	83269087		
	I	X1	83261097	-	83263097	83264097	83265097	83268097	83269097		
	R	W1	83261607	83262607	83263607	83264607	83265607	83268607	83269607		
	R	W2	83261617	83262617	83263617	83264617	83265617	83268617	83269617		
	R	W3	83261627	83262627	83263627	83264627	83265627	83268627	83269627		
	R	W3R5	83261637	83262637	83263637	83264637	83265637	83268637	83269637		
	R	W6A5	83261647	83262647	83263647	83264647	83265647	83268647	83269647		
	R	W6D8	83261657	83262657	83263657	83264657	83265657	83268657	83269657		
	R	W7A5	83261667	-	83263667	83264667	83265667	83268667	83269667		
	C	W1	83261807	83262807	83263807	83264807	83265807	83268807	83269807		
	C	W2	83261817	83262817	83263817	83264817	83265817	83268817	83269817		
	C	W3	83261827	83262827	83263827	83264827	83265827	83268827	83269827		
	C	W3R5	83261837	83262837	83263837	83264837	83265837	83268837	83269837		
	C	W6A5	83261847	83262847	83263847	83264847	83265847	83268847	83269847		
	C	W6D8	83261857	83262857	83263857	83264857	83265857	83268857	83269857		
	C	W7A5	83261867	-	83263867	83264867	83265867	83268867	83269867		

Note:

Function: **I** = Changeover - **R** = Normally closed - **C** = Normally open
 Connection: **W1** = screws - **W2** = solder - **W3** = for 6.35 mm clips - **W3R5** = for Rast 5 connector
W6A5 = for 4.8 x 0.5 mm clips - **W6D8** = for 4.8 x 0.8 mm clips - **W7A5** = for 2.8 x 0.5 mm clips
X2 = rear side for PCB - **X3** = front side for PCB - **X1** = straight for PCB

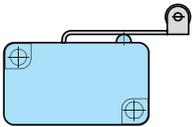
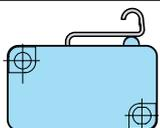
		Rating / Force	16 A / 2 N	20 A / 2 N	16 A / 1 N	12 A / 0.5 N	5 A / 0.25 N	0.05 A / 1 N	0.05 A / 0.25 N
		Type	83261	83262	83263	83264	83265	83268	83269
Actuators	Function	Connection							
 <p>Lever 260E R24.3 Pos B</p>	I	W1	83261008	83262008	83263008	83264008	83265008	83268008	83269008
	I	W2	83261018	83262018	83263018	83264018	83265018	83268018	83269018
	I	W3	83261028	83262028	83263028	83264028	83265028	83268028	83269028
	I	W3R5	83261038	83262038	83263038	83264038	83265038	83268038	83269038
	I	W6A5	83261048	83262048	83263048	83264048	83265048	83268048	83269048
	I	W6D8	83261058	83262058	83263058	83264058	83265058	83268058	83269058
	I	W7A5	83261068	-	83263068	83264068	83265068	83268068	83269068
	I	X2	83261078	-	83263078	83264078	83265078	83268078	83269078
	I	X3	83261088	-	83263088	83264088	83265088	83268088	83269088
	I	X1	83261098	-	83263098	83264098	83265098	83268098	83269098
	R	W1	83261608	83262608	83263608	83264608	83265608	83268608	83269608
	R	W2	83261618	83262618	83263618	83264618	83265618	83268618	83269618
	R	W3	83261628	83262628	83263628	83264628	83265628	83268628	83269628
	R	W3R5	83261638	83262638	83263638	83264638	83265638	83268638	83269638
	R	W6A5	83261648	83262648	83263648	83264648	83265648	83268648	83269648
	R	W6D8	83261658	83262658	83263658	83264658	83265658	83268658	83269658
	R	W7A5	83261668	-	83263668	83264668	83265668	83268668	83269668
	C	W1	83261808	83262808	83263808	83264808	83265808	83268808	83269808
	C	W2	83261818	83262818	83263818	83264818	83265818	83268818	83269818
C	W3	83261828	83262828	83263828	83264828	83265828	83268828	83269828	
C	W3R5	83261838	83262838	83263838	83264838	83265838	83268838	83269838	
C	W6A5	83261848	83262848	83263848	83264848	83265848	83268848	83269848	
C	W6D8	83261858	83262858	83263858	83264858	83265858	83268858	83269858	
C	W7A5	83261868	-	83263868	83264868	83265868	83268868	83269868	
 <p>Lever 260G R13.8 Pos B</p>	I	W1	83261009	83262009	83263009	83264009	83265009	83268009	83269009
	I	W2	83261019	83262019	83263019	83264019	83265019	83268019	83269019
	I	W3	83261029	83262029	83263029	83264029	83265029	83268029	83269029
	I	W3R5	83261039	83262039	83263039	83264039	83265039	83268039	83269039
	I	W6A5	83261049	83262049	83263049	83264049	83265049	83268049	83269049
	I	W6D8	83261059	83262059	83263059	83264059	83265059	83268059	83269059
	I	W7A5	83261069	-	83263069	83264069	83265069	83268069	83269069
	I	X2	83261079	-	83263079	83264079	83265079	83268079	83269079
	I	X3	83261089	-	83263089	83264089	83265089	83268089	83269089
	I	X1	83261099	-	83263099	83264099	83265099	83268099	83269099
	R	W1	83261609	83262609	83263609	83264609	83265609	83268609	83269609
	R	W2	83261619	83262619	83263619	83264619	83265619	83268619	83269619
	R	W3	83261629	83262629	83263629	83264629	83265629	83268629	83269629
	R	W3R5	83261639	83262639	83263639	83264639	83265639	83268639	83269639
	R	W6A5	83261649	83262649	83263649	83264649	83265649	83268649	83269649
	R	W6D8	83261659	83262659	83263659	83264659	83265659	83268659	83269659
	R	W7A5	83261669	-	83263669	83264669	83265669	83268669	83269669
	C	W1	83261809	83262809	83263809	83264809	83265809	83268809	83269809
	C	W2	83261819	83262819	83263819	83264819	83265819	83268819	83269819
C	W3	83261829	83262829	83263829	83264829	83265829	83268829	83269829	
C	W3R5	83261839	83262839	83263839	83264839	83265839	83268839	83269839	
C	W6A5	83261849	83262849	83263849	83264849	83265849	83268849	83269849	
C	W6D8	83261859	83262859	83263859	83264859	83265859	83268859	83269859	
C	W7A5	83261869	-	83263869	83264869	83265869	83268869	83269869	

Note:

Function: **I** = Changeover - **R** = Normally closed - **C** = Normally open

Connection: **W1** = screws - **W2** = solder - **W3** = for 6.35 mm clips - **W3R5** = for Rast 5 connector

W6A5 = for 4.8 x 0.5 mm clips - **W6D8** = for 4.8 x 0.8 mm clips - **W7A5** = for 2.8 x 0.5 mm clips

X2 = rear side for PCB - **X3** = front side for PCB - **X1** = straight for PCB



AMERICA

BRAZIL

Custom Sensors & Technologies
Crouzet Latinoamerica
 Alameda Rio Negro
 1084 - cj.A31
 CEP 06454-000 - Alphaville - SP BRASIL
 Tel. : +55 (11) 4191 9797
 Fax : +55 (11) 4191 9136
 E-mail : info@cst-latinoamerica.com
 www.crouzet.com.br
 www.cst-latinoamerica.com

USA/CANADA/MEXICO

Custom Sensors & Technologies - Crouzet
 7230 Hollister Avenue
 Goleta, CA, 93117
 USA
 Tel. : +1 (800) 677 5311
 Fax : +1 (800) 677 3865
 E-mail : customer.service@us.crouzet.com
 www.crouzet.com

OTHER COUNTRIES

Custom Sensors & Technologies
Crouzet Latinoamerica
 Alameda Rio Negro
 1084 - cj.A31
 CEP 06454-000 - Alphaville - SP BRASIL
 Tel. : +55 (11) 4191 9797
 Fax : +55 (11) 4191 9136
 E-mail : info@cst-latinoamerica.com
 www.crouzet.com.br
 www.cst-latinoamerica.com

EUROPE MIDDLE EAST AFRICA

AUSTRIA

Crouzet GmbH
 Zweigniederlassung Österreich
 Spengergasse 1/3
 1050 Wien
 ÖSTERREICH
 Tel. : +43 (0) 1 36 85 471
 Fax : +43 (0) 1 36 85 472
 E-mail : info-direkt@crouzet.com
 www.crouzet.at

BELGIUM

Crouzet NV/SA
 Dieweg 3 B
 B - 1180 Uccle
 BELGIUM
 Tel. : +32 (0) 2 462 07 30
 Fax : +32 (0) 2 461 00 23
 E-mail : com-be@crouzet.com
 www.crouzet.be

FRANCE

Crouzet Automatismes SAS
 2 rue du Docteur Abel - BP 59
 26902 Valence CEDEX 9
 FRANCE
 Tel. : +33 (0) 4 75 44 88 44
 Fax : +33 (0) 4 75 55 98 03
 E-mail : com-fr@crouzet.com
 www.crouzet.fr

Customer service

Indigo 0 825 333 351

Azur FAX 0 810 610 102

GERMANY

Crouzet GmbH
 Otto-Hahn-Str. 3, 40721 Hilden
 Postfach 203, 40702 Hilden
 DEUTSCHLAND
 Tel. : +49 (0) 21 03 9 80-171
 Fax : +49 (0) 21 03 9 80-222
 E-mail : info-direkt@crouzet.com
 www.crouzet.de

ITALY

Crouzet Componenti s.r.l.
 Via Viganò De Vizzi, 93/95
 20092 Cinisello Balsamo (MI)
 ITALIA
 Tel. : +39 (02) 66 599 250
 Fax : +39 (02) 66 599 258
 E-mail : crz-it-sensori-micro@crouzet.com
 www.crouzet.it

SPAIN/PORTUGAL

Crouzet Ibérica
 C/ Aragón 224, 2º 2ª
 08011 Barcelona
 ESPAÑA
 Tel. : +34 (93) 484 39 70
 Fax : +34 (93) 484 39 73
 E-mail : es-consultas@crouzet.es
 www.crouzet.es

THE NETHERLANDS

Crouzet BV
 Industrieweg 17
 2382 NR Zoeterwoude
 NEDERLAND
 Tel. : +31 (0) 71-581 20 30
 Fax : +31 (0) 71-541 35 74
 E-mail : com-nl@crouzet.com
 www.crouzet.nl

UNITED KINGDOM

Crouzet Ltd
 8 Cedarwood
 Chineham Business Park
 Crockford Lane
 Basingstoke, Hampshire
 RG24 8WD
 UNITED KINGDOM
 Tel. : +44 (0)1256 318 900
 Fax : +44 (0)1256 318 901
 E-mail : info@crouzet.co.uk
 www.crouzet.co.uk

SWITZERLAND

Crouzet AG
 Gewerbebark - Postfach 56
 5506 Mägenwil
 SCHWEIZ
 Tel. : +41(0) 62 887 30 30
 Fax : +41(0) 62 887 30 40
 E-mail : info-direkt@crouzet.com
 www.crouzet.ch

OTHER COUNTRIES

Crouzet Automatismes SAS
 2 rue du Docteur Abel - BP 59
 26902 Valence CEDEX 9
 FRANCE
 Tel. : +33 (0) 475 802 102
 Fax : +33 (0) 475 448 126
 E-mail : com-ex@crouzet.com
 www.crouzet.com

ASIA PACIFIC

CHINA & HONG KONG

Custom Sensors & Technologies Asia (Shanghai) Limited - Crouzet
 2 Floor, Innovation Building
 No. 1009, Yi Shan Road
 Shanghai 200233
 CHINA
 Tel. : +86 (21) 2401 7766
 Fax : +86 (21) 6249 0701
 E-mail : china@cstsensors.com
 www.crouzet.cn
 www.cstsensors.com

INDIA

Custom Sensors & Technologies - Crouzet
 Prestige Meridian II
 No. 30, 13th Floor,
 Unit No: 1301 & 1302
 Mahatma Gandhi Road
 Bangalore 560 001
 INDIA
 Tel. : +91 (0) 80 4113 2204/05
 Fax : +91 (0) 80 4113 2206
 E-mail : crz_bangalore@crouzet.com
 www.crouzet.co.in
 www.cstsensors.com

TAIWAN

Custom Sensors & Technologies - Crouzet
 3F, No. 39, Ji-Hu Road
 Nei-Hu Dist. - Taipei 114
 TAIWAN
 Tel. : +886 (0)2 8751 6388
 Fax : +886 (0)2 2657 8725
 E-mail : taiwan@cstsensors.com
 www.crouzet.tw
 www.cstsensors.com

KOREA & JAPAN

Custom Sensors & Technologies - Crouzet
 5F, Jeil Bldg,
 94-46 Youngdeungpo-dong
 7-ga Youngdeungpo-gu
 Seoul 150-037
 SOUTH KOREA
 Tel. : +82 (0)2 2629 8312
 Fax : +82 (0)2 2629 8310
 E-mail : korea@cstsensors.com
 www.crouzet.tw
 www.cstsensors.com

SOUTH EAST ASIA & PACIFIC

Custom Sensors & Technologies - Crouzet
 3F, No. 39, Ji-Hu Road
 Nei-Hu Dist. - Taipei 114
 TAIWAN
 Tel. : +886 (0)2 8751 6388
 Fax : +886 (0)2 2657 8725
 E-mail : eap@cstsensors.com
 www.crouzet.tw
 www.cstsensors.com

Warning:
 The product information contained in this catalogue is given purely as information and does not constitute a representation, warranty or any form of contractual commitment. CROUZET Automatismes and its subsidiaries reserve the right to modify their products without notice. It is imperative that we should be consulted over any particular use or application of our products and it is the responsibility of the buyer to establish, particularly through all the appropriate tests, that the product is suitable for the use or application. Under no circumstances will our warranty apply, nor shall we be held responsible for any application (such as any modification, addition, deletion, use in conjunction with other electrical or electronic components, circuits or assemblies, or any other unsuitable material or substance) which has not been expressly agreed by us prior to the sale of our products.

Headquartered in Moorpark, California-USA, **Custom Sensors & Technologies (CST)** is made up of the leading brands of Crouzet, Kavlico and Crydom, as well as the former divisions of BEI Technologies, including Newall and Systron Donner. CST provides sensors, controls, and actuation products to the transportation, industrial, and aerospace & defense markets.

www.cstsensors.com

Distributed by:

Crouzet Automatismes SAS

2 rue du Docteur Abel - BP 59
 26902 Valence CEDEX 9
 FRANCE

www.crouzet.com

CRZ BR 42/A EN
 Ref. 67231008 EN
 11/2009

Creation-Design: 3C Evolution, Crouzet Automatismes
 Editing-Publishing: 3C Evolution
 Photos-Graphics: Ginko, Daniel Lattard, Schneider Electric
 Printing:



Компания «ЭлектроПласт» предлагает заключение долгосрочных отношений при поставках импортных электронных компонентов на взаимовыгодных условиях!

Наши преимущества:

- Оперативные поставки широкого спектра электронных компонентов отечественного и импортного производства напрямую от производителей и с крупнейших мировых складов;
- Поставка более 17-ти миллионов наименований электронных компонентов;
- Поставка сложных, дефицитных, либо снятых с производства позиций;
- Оперативные сроки поставки под заказ (от 5 рабочих дней);
- Экспресс доставка в любую точку России;
- Техническая поддержка проекта, помощь в подборе аналогов, поставка прототипов;
- Система менеджмента качества сертифицирована по Международному стандарту ISO 9001;
- Лицензия ФСБ на осуществление работ с использованием сведений, составляющих государственную тайну;
- Поставка специализированных компонентов (Xilinx, Altera, Analog Devices, Intersil, Interpoint, Microsemi, Aeroflex, Peregrine, Syfer, Eurofarad, Texas Instrument, Miteq, Cobham, E2V, MA-COM, Hittite, Mini-Circuits, General Dynamics и др.);

Помимо этого, одним из направлений компании «ЭлектроПласт» является направление «Источники питания». Мы предлагаем Вам помощь Конструкторского отдела:

- Подбор оптимального решения, техническое обоснование при выборе компонента;
- Подбор аналогов;
- Консультации по применению компонента;
- Поставка образцов и прототипов;
- Техническая поддержка проекта;
- Защита от снятия компонента с производства.



Как с нами связаться

Телефон: 8 (812) 309 58 32 (многоканальный)

Факс: 8 (812) 320-02-42

Электронная почта: org@eplast1.ru

Адрес: 198099, г. Санкт-Петербург, ул. Калинина, дом 2, корпус 4, литера А.