



■ Timing applications



■ Valves



■ HVAC



# Microswitches

miniature

## V3D

# Microswitches miniature V3D

## Crouzet Presentation

|  |      |
|--|------|
| ■ Adaptation                                   | p. 3 |
| ■ Customisation is our business                | p. 4 |
| ■ V3D Advantages                               | p. 5 |
| ■ Ordering information                         | p. 5 |
| ■ Basic technical principles                   | p. 5 |
| ■ Main specifications                          | p. 6 |
| ■ Additional specifications                    | p. 6 |
| ■ Principle                                    | p. 7 |
| ■ Dimensions                                   | p. 7 |
| ■ Product adaptations                          | p. 7 |
| ■ Connections                                  | p. 8 |
| ■ Actuators                                    | p. 9 |
| ■ Mounting-Operation                           | p. 9 |
| ■ Mechanical characteristics<br>with actuators | p.10 |
| ■ Selection guide                              | p.11 |

**Crouzet** has been a recognised supplier of quality position sensors, micro-switches and limit switches for more than 30 years. Today, **Crouzet** offers you a new range of micro-switches designed to fulfill the toughest of OEMs' requirements.

To suit your design requirements, Crouzet continues to develop its capabilities as a specialist in customisation, offering you solutions specifically adapted to all your applications. Because our top most priority is nothing be left to chance, our quality and environmental management systems are certified to ISO 9001 and ISO 14001.

### About Custom Sensors & Technologies



Headquartered in Moorpark, CA - Custom Sensors & Technologies (CST) is comprised of industry-leading brands including Crouzet, Kavlico, Crydom, and former divisions of BEI Technologies – Newall and Systron Donner. CST provides sensors, controls, and actuation products for the Transportation, Industrial and Aerospace & Defense markets.



# Crouzet

## Adaptation

To meet the growing demand for customisation, Crouzet's expertise in terms of adapting products and their corresponding accessories is available to all customers.

Crouzet can customise its products for use in any type of environment or application to ensure perfect integration into any equipment.

Because quality is at the heart of our approach, our quality control and environmental management system are certified to ISO 9001 and ISO 14001 respectively.

■ All our expertise in sensing design and industrialisation placed at your service, to respond to a **specific need** dedicated to your application.

■ A complete range of **standard microswitches** available immediately to create your sensing application.

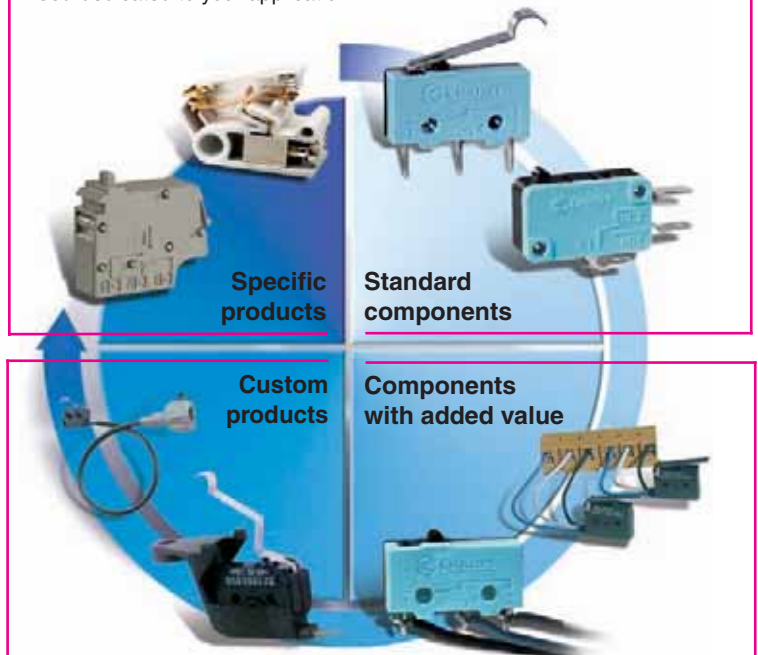

■ Defined in coordination with our technical sales teams, these **custom products** have the corresponding performance and functionality.

■ Standard products complemented by **factory-mounted auxiliaries or accessories** (levers, cables, connectors, etc) in order to assist integration in your equipment, simplify your logistics and maximise the reliability of your installation.

# Crouzet

## Process



■ Customer needs



■ R&D department



■ Production



■ Quality

# Microswitches miniature V3D

## Crouzet

### Customisation is our business

#### □ Control devices

**Even more adaptation for easier actuating**

Special button shapes which compensate for any faults or positioning drift of the control actuator.



#### □ Connections

**A complete electrical function**

Special connectors, customised wiring, customer bundles, dedicated terminals...



#### □ Seals

**Even more solutions for demanding environments**

Numerous components available to provide effective protection for your contacts, including caps, boot seals, membranes, sealing resin, wiper seals.



#### □ Special levers

**Obtain the control data**

Angled, curved, extended or retractable... these special lever types can be used to extend the control device for easier adjustment, increase the operating force, resist high actuation torque or provide totally safe electrical isolation.



#### □ Special contacts

**The right contact for every environment**

High or low current, AC or DC, type of load (inductive or resistive), industrial or corrosive atmosphere, occasional or intensive use. The best metals, silver, silver nickel, silver palladium, gold-plated silver, solid gold.



#### □ Special fixings

**No effort is spared to make mounting easier**

Snap-on fixing, screw-fixing, crimping or pins are just a few examples of the numerous solutions available to meet all your requirements.



# V3D Advantages

- Wide range of switching ratings from 0.1 A to 21 A
- V3 standard size
- Approved to ENEC (EN 61058-1) and UL/CSA
- Compliant to RoHS
- Glow wire test withstanding to EN 60335-1: GWFI 850°C and GWIT 775°C
- Various applications areas: Industry, Consumer equipment, Home appliances, HVAC, ...
- A high capacity to adapt levers, connections, fixing elements, upon request

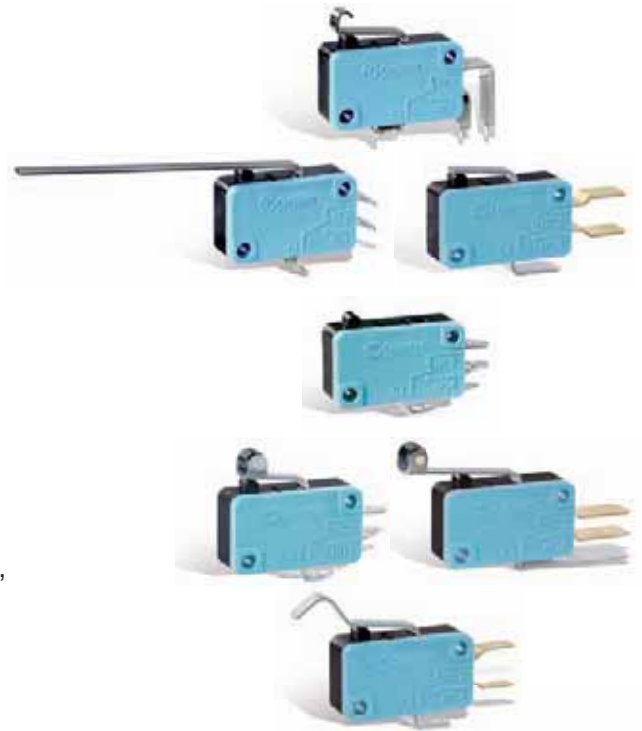

# Ordering Information

## Model Number Legend

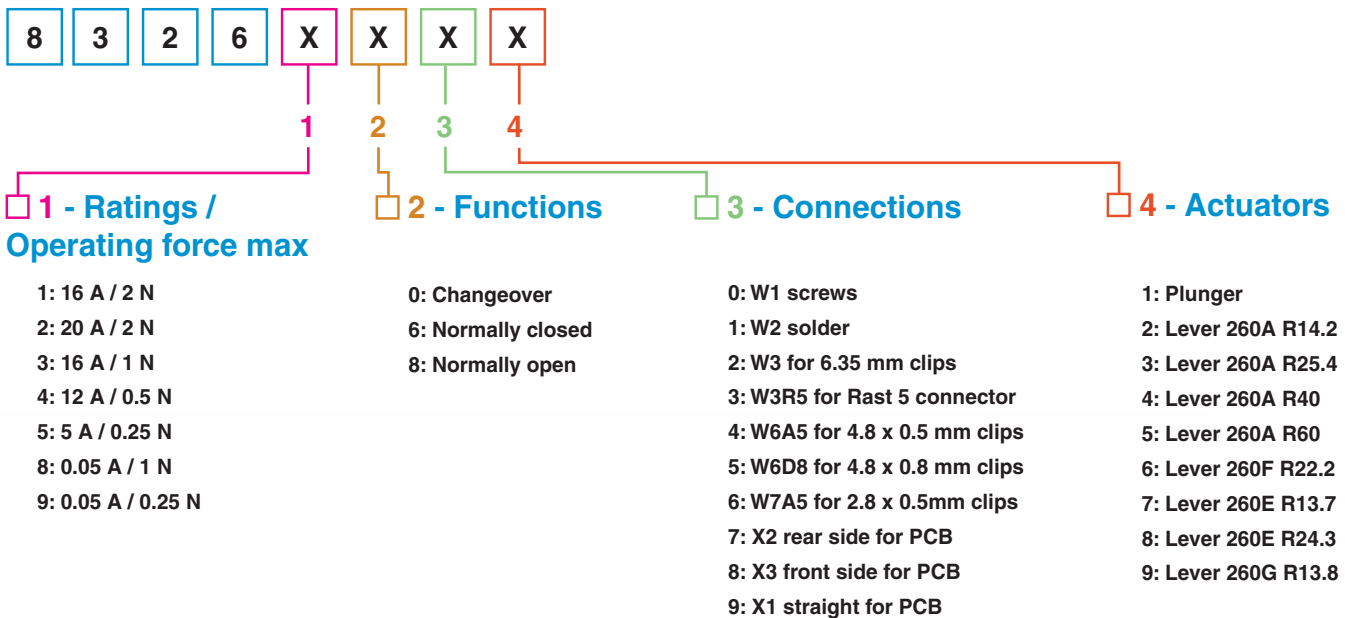

W3R2.5 for Rast 2.5 connector (SP9307): Contact us

# Basic technical principles

- See our Position Sensors Catalogue

# Microswitches miniature V3D

- Nominal ratings from 0.1 A to 21 A
- Operating temperature up to + 150°C
- Approved to ENEC and UL/CSA
- Large choice of actuators



## Main specifications

|   |  | 83261                  | 83262  | 83263                  | 83264                           |
|---|--|------------------------|--|------------------------|---------------------------------|
| <b>Function</b>                         | <b>Connections</b>                                       |                        |  |                        |                                 |
| I (changeover)                          | W1 - W2 - W3 - W3R5 - W6A5<br>W6D8 - W7A5 - X1 - X2 - X3 | ●                      | ●  | ●                      | ●                               |
| R (normally closed)                     | W1 - W2 - W3 - W3R5 - W6A5<br>W6D8 - W7A5                | ●                      | ●  | ●                      | ●                               |
| C (normally open)                       | W1 - W2 - W3 - W3R5 - W6A5<br>W6D8 - W7A5                | ●                      | ●  | ●                      | ●                               |
| <b>Electrical characteristics</b>       |  |                        |  |                        |                                 |
| Rating nominal / 250 V AC (A)           |  | 16                     | 20   | 16                     | 12                              |
| Rating thermal / 250 V AC (A)           |  | 20                     | 25   | 20                     | 15                              |
| Rating nominal / 5 → 24 V AC/DC (A)     |  | -                      | -  | -                      | -                               |
| <b>Mechanical characteristics</b>       |  |                        |  |                        |                                 |
| Maximum operating force (N)             |  | 2                      | 2  | 1                      | 0.5                             |
| Min. Release force (N)                  |  | 0.5                    | 0.5  | 0.2                    | 0.1                             |
| Maximum total travel force (N)          |  | 3                      | 3  | 1.5                    | 0.8                             |
| Max. permitted overtravel force (N)     |  | 20                     | 20   | 20                     | 20                              |
| Maximum rest position (mm)              |  | 16.2                   | 16.2   | 16.2                   | 16.2                            |
| Tripping point (mm)                     |  | 14.7 <sup>+0.5</sup>   | 14.7 <sup>+0.5</sup>                                       | 14.7 <sup>+0.5</sup>   | 14.7 <sup>+0.5</sup>            |
| Maximum differential travel (mm)        |  | 0.40                   | 0.40   | 0.40                   | 0.40                            |
| Min. overtravel (mm)                    |  | 1.1                    | 1.1  | 1.1                    | 1.1                             |
| Ambient operating temperature (°C)      |  | -20 → +125             | -20 → +125   | -20 → +125             | -20 → +125                      |
| Mechanical life for 2/3 OT (operations) |  | 1 000 000              | 1 000 000  | 1 000 000              | 1 000 000                       |
| Contact gap (mm)                        |  | 0.6                    | 0.6  | 0.6                    | 0.6                             |
| Weight (g)                              |  | 6                      | 6  | 6                      | 6                               |
| <b>Approvals</b>                        |  |                        |  |                        |                                 |
| EN 61058-1                              | Rating for T125°C<br>** T150°C<br>*** T85°C              | 16 (4) A<br>250 V AC   | 20 (8) A<br>250 V AC                                       | 16 (4) A<br>250 V AC   | ***12 (6) A<br>250 V AC         |
|   | Number of cycles   | 50 000                 | 10 000   | 50 000                 | 50 000                          |
| UL 1054                                 | Rating   | 16 A<br>125 / 250 V AC | 21 A<br>125 / 250 V AC<br>1/2 HP 125 V AC<br>1 HP 250 V AC | 16 A<br>125 / 250 V AC | 8 A 1/4 HP<br>125 / 250<br>V AC |
|   | Number of cycles   | 6 000                  | 6 000  | 6 000                  | 6 000                           |

## Additional specifications

### Component Materials

- Housing/cover/button: polyester UL 94V0 - GWIT 775°C / GWFI 850°C
- Blade/spring: copper alloy
- Contacts: silver alloy or gold plated
- Terminals: brass or silver plated brass
- Actuators: stainless steel, glass filled polyamide roller



| 83265                         | 83268                           | 83269                           |
|-------------------------------|---------------------------------|---------------------------------|
| ●                             | ●                               | ●                               |
| ●                             | ●                               | ●                               |
| ●                             | ●                               | ●                               |
| 5                             | -                               | -                               |
| 7.5                           | -                               | -                               |
| -                             | 0.001 → 0.05                    | 0.001 → 0.05                    |
| 0.25                          | 1                               | 0.25                            |
| 0.05                          | 0.2                             | 0.05                            |
| 0.4                           | 1.5                             | 0.4                             |
| 20                            | 20                              | 20                              |
| 16.2                          | 16.2                            | 16.2                            |
| 14.7 <sup>±0.5</sup>          | 14.7 <sup>±0.5</sup>            | 14.7 <sup>±0.5</sup>            |
| 0.40                          | 0.40                            | 0.40                            |
| 1.1                           | 1.1                             | 1.1                             |
| -20 → +125                    | -20 → +150                      | -20 → +150                      |
| 1 000 000                     | 1 000 000                       | 1 000 000                       |
| 0.6                           | 0.6                             | 0.6                             |
| 6                             | 6                               | 6                               |
| ** 5 (1) A<br>250 V AC        | ** 0.1 (0.04) A<br>250 V AC     | ** 0.1 (0.04) A<br>250 V AC     |
| 50 000                        | 50 000                          | 50 000                          |
| 5 A 1/10 HP<br>125 / 250 V AC | 0.1 A 125 V AC<br>0.1 A 30 V DC | 0.1 A 125 V AC<br>0.1 A 30 V DC |
| 6 000                         | 6 000                           | 6 000                           |

## Principle

Single break changeover switch

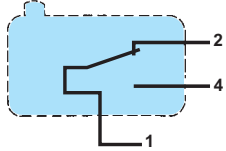

## Dimensions (mm)

V3D

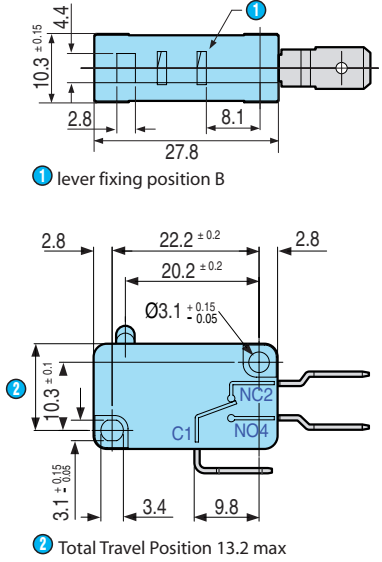

## Product adaptations



- Rast 2.5 connection (SP9307): see [Connections](#)
- Other specific connections
- Specific levers
- Specific contacts
- Specific fixing
- High operating temperature

# Microswitches miniature V3D

## Connections

W1

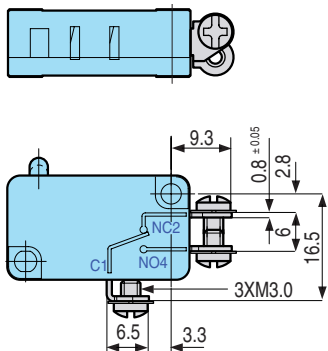

W2

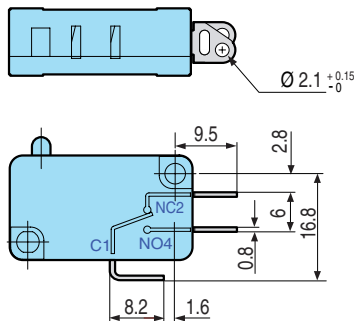

W3

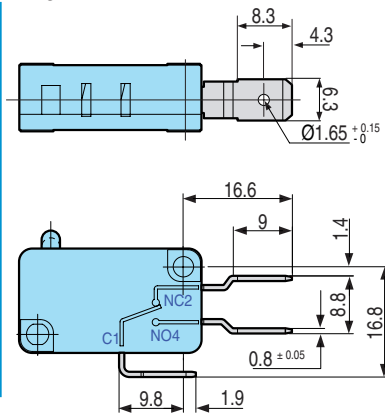

W3R5

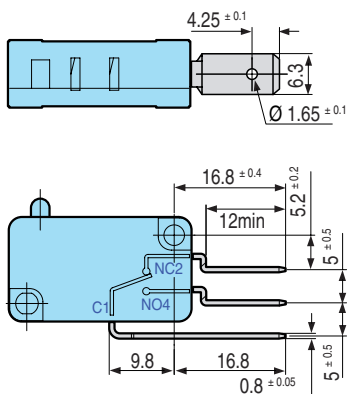

W6A5

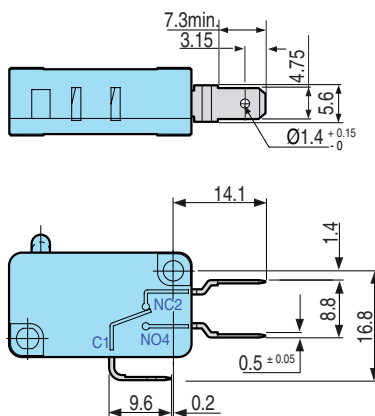

W6D8

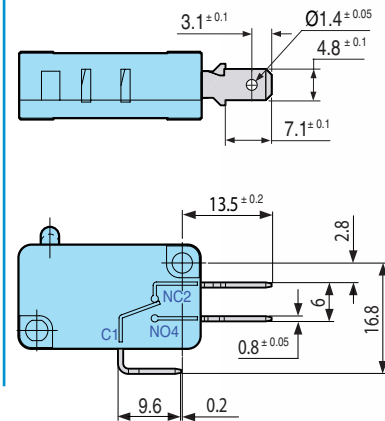

W7A5

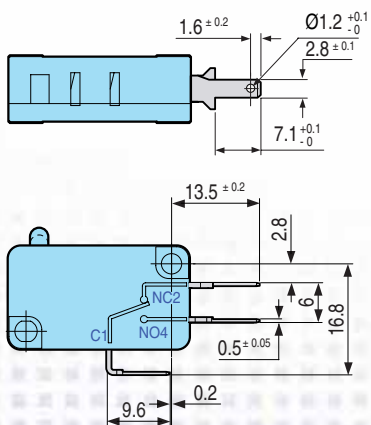

X1

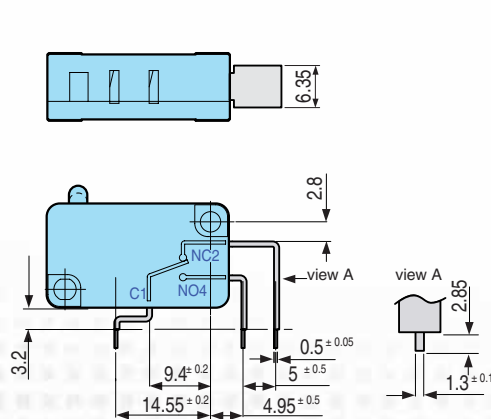

X2

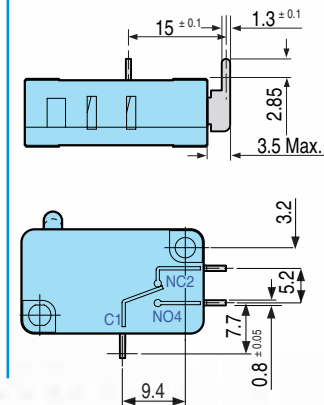



X3

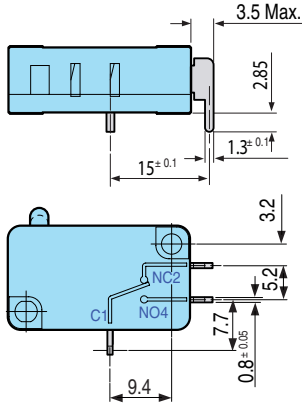

W3R2.5 (SP9307)

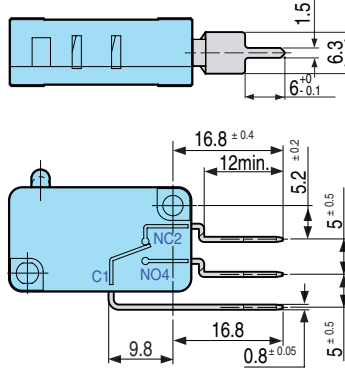

Contact us

## Actuators

260 A

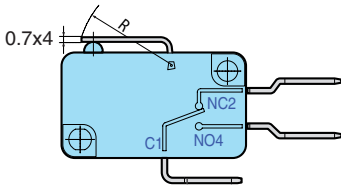

260 E

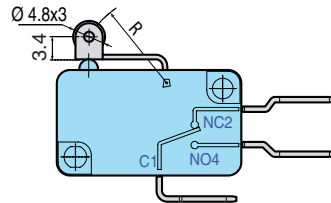

260 F

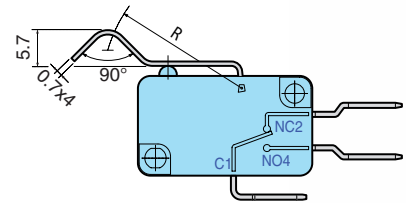

260 G

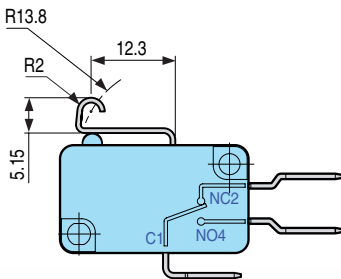

## Actuator mounting position

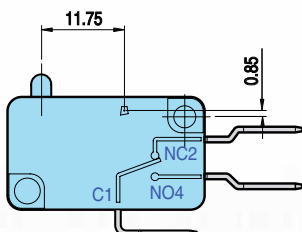

## Mounting - Operation

To conform to the leakage paths and air gaps required in the standard EN/IEC 61058-1 - EN/IEC 60947-5-1:

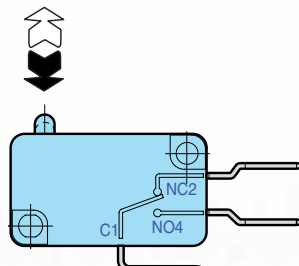

- An insulation pad must be inserted between the microswitch and the fixing surface if the fixing surface is metal.
- Manual operation of a metal actuator must only be carried out with the help of a secondary actuator made of insulating material. The installer must ensure adequate protection against direct contact with the output terminals.

# Microswitches miniature V3D

## Mechanical characteristics with actuators

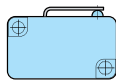
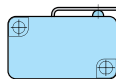
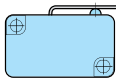
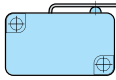
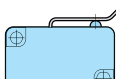
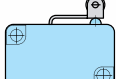
|   |       | Length of actuator (mm) | Maximum operating force (N) | Minimum release force (N) | Tripping point (mm) | Minimum overtravel (mm) | Maximum differential travel (mm) | Maximum total travel (mm) |
|---|-------|-------------------------|-----------------------------|---------------------------|---------------------|-------------------------|----------------------------------|---------------------------|
|  <p>Lever 260A<br/>R14.2 Pos B</p>   | 83261 | 14.2                    | 2                           | 0.5                       | 15.4 $\pm$ 0.5      | 1.1                     | 0.4                              | 3                         |
|   | 83262 | 14.2                    | 2                           | 0.5                       | 15.4 $\pm$ 0.5      | 1.1                     | 0.4                              | 3                         |
|   | 83263 | 14.2                    | 1                           | 0.2                       | 15.4 $\pm$ 0.5      | 1.1                     | 0.4                              | 3                         |
|   | 83264 | 14.2                    | 0.5                         | 0.1                       | 15.4 $\pm$ 0.5      | 1.1                     | 0.4                              | 3                         |
|   | 83265 | 14.2                    | 0.25                        | 0.05                      | 15.4 $\pm$ 0.5      | 1.1                     | 0.4                              | 3                         |
|   | 83268 | 14.2                    | 1                           | 0.2                       | 15.4 $\pm$ 0.5      | 1.1                     | 0.4                              | 3                         |
|   | 83269 | 14.2                    | 0.25                        | 0.05                      | 15.4 $\pm$ 0.5      | 1.1                     | 0.4                              | 3                         |
|  <p>Lever 260A<br/>R25.4 Pos B</p>   | 83261 | 25.4                    | 1                           | 0.25                      | 15.4 $\pm$ 1        | 2                       | 0.8                              | 5.8                       |
|   | 83262 | 25.4                    | 1                           | 0.25                      | 15.4 $\pm$ 1        | 2                       | 0.8                              | 5.8                       |
|   | 83263 | 25.4                    | 0.5                         | 0.1                       | 15.4 $\pm$ 1        | 2                       | 0.8                              | 5.8                       |
|   | 83264 | 25.4                    | 0.25                        | 0.05                      | 15.4 $\pm$ 1        | 2                       | 0.8                              | 5.8                       |
|   | 83265 | 25.4                    | 0.13                        | 0.02                      | 15.4 $\pm$ 1        | 2                       | 0.8                              | 5.8                       |
|   | 83268 | 25.4                    | 0.5                         | 0.1                       | 15.4 $\pm$ 1        | 2                       | 0.8                              | 5.8                       |
|   | 83269 | 25.4                    | 0.13                        | 0.02                      | 15.4 $\pm$ 1        | 2                       | 0.8                              | 5.8                       |
|  <p>Lever 260A<br/>R40 Pos B</p>    | 83261 | 40                      | 0.6                         | 0.15                      | 15.4 $\pm$ 1.8      | 3.3                     | 1.3                              | 9.6                       |
|   | 83262 | 40                      | 0.6                         | 0.15                      | 15.4 $\pm$ 1.8      | 3.3                     | 1.3                              | 9.6                       |
|   | 83263 | 40                      | 0.3                         | 0.06                      | 15.4 $\pm$ 1.8      | 3.3                     | 1.3                              | 9.6                       |
|   | 83264 | 40                      | 0.15                        | 0.03                      | 15.4 $\pm$ 1.8      | 3.3                     | 1.3                              | 9.6                       |
|   | 83265 | 40                      | 0.08                        | 0.01                      | 15.4 $\pm$ 1.8      | 3.3                     | 1.3                              | 9.6                       |
|   | 83268 | 40                      | 0.3                         | 0.06                      | 15.4 $\pm$ 1.8      | 3.3                     | 1.3                              | 9.6                       |
|   | 83269 | 40                      | 0.08                        | 0.01                      | 15.4 $\pm$ 1.8      | 3.3                     | 1.3                              | 9.6                       |
|  <p>Lever 260A<br/>R60 Pos B</p>   | 83261 | 60                      | 0.4                         | 0.1                       | 15.4 $\pm$ 2.5      | 5                       | 2                                | 14.5                      |
|   | 83262 | 60                      | 0.4                         | 0.1                       | 15.4 $\pm$ 2.5      | 5                       | 2                                | 14.5                      |
|   | 83263 | 60                      | 0.2                         | 0.04                      | 15.4 $\pm$ 2.5      | 5                       | 2                                | 14.5                      |
|   | 83264 | 60                      | 0.1                         | 0.02                      | 15.4 $\pm$ 2.5      | 5                       | 2                                | 14.5                      |
|   | 83265 | 60                      | 0.05                        | 0.01                      | 15.4 $\pm$ 2.5      | 5                       | 2                                | 14.5                      |
|   | 83268 | 60                      | 0.2                         | 0.04                      | 15.4 $\pm$ 2.5      | 5                       | 2                                | 14.5                      |
|   | 83269 | 60                      | 0.05                        | 0.01                      | 15.4 $\pm$ 1        | 5                       | 2                                | 14.5                      |
|  <p>Lever 260F<br/>R22.2 Pos B</p> | 83261 | 22.2                    | 1.06                        | 0.26                      | 20.4 $\pm$ 1        | 1.8                     | 0.75                             | 5.2                       |
|   | 83262 | 22.2                    | 1.06                        | 0.26                      | 20.4 $\pm$ 1        | 1.8                     | 0.75                             | 5.2                       |
|   | 83263 | 22.2                    | 0.53                        | 0.1                       | 20.4 $\pm$ 1        | 1.8                     | 0.75                             | 5.2                       |
|   | 83264 | 22.2                    | 0.27                        | 0.05                      | 20.4 $\pm$ 1        | 1.8                     | 0.75                             | 5.2                       |
|   | 83265 | 22.2                    | 0.13                        | 0.02                      | 20.4 $\pm$ 1        | 1.8                     | 0.75                             | 5.2                       |
|   | 83268 | 22.2                    | 0.53                        | 0.1                       | 20.4 $\pm$ 1        | 1.8                     | 0.75                             | 5.2                       |
|   | 83269 | 22.2                    | 0.13                        | 0.02                      | 20.4 $\pm$ 1        | 1.8                     | 0.75                             | 5.2                       |
|  <p>Lever 260E<br/>R13.7 Pos B</p> | 83261 | 13.7                    | 2                           | 0.5                       | 20.5 $\pm$ 0.8      | 1.1                     | 0.4                              | 3                         |
|   | 83262 | 13.7                    | 2                           | 0.5                       | 20.5 $\pm$ 0.8      | 1.1                     | 0.4                              | 3                         |
|   | 83263 | 13.7                    | 1                           | 0.2                       | 20.5 $\pm$ 0.8      | 1.1                     | 0.4                              | 3                         |
|   | 83264 | 13.7                    | 0.5                         | 0.1                       | 20.5 $\pm$ 0.8      | 1.1                     | 0.4                              | 3                         |
|   | 83265 | 13.7                    | 0.25                        | 0.05                      | 20.5 $\pm$ 0.8      | 1.1                     | 0.4                              | 3                         |
|   | 83268 | 13.7                    | 1                           | 0.2                       | 20.5 $\pm$ 0.8      | 1.1                     | 0.4                              | 3                         |
|   | 83269 | 13.7                    | 0.25                        | 0.05                      | 20.5 $\pm$ 0.8      | 1.1                     | 0.4                              | 3                         |

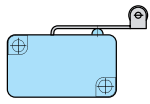

Lever 260E  
R24.3 Pos B

|       |      | Length of actuator (mm) | Maximum operating force (N) | Minimum release force (N) | Tripping point (mm) | Minimum overtravel (mm) | Maximum differential travel (mm) | Maximum total travel (mm) |
|-------|------|-------------------------|-----------------------------|---------------------------|---------------------|-------------------------|----------------------------------|---------------------------|
| 83261 | 24.3 | 1                       | 0.25                        | 20.5 <sup>+1.5</sup>      | 2                   | 0.8                     | 5.8                              |                           |
| 83262 | 24.3 | 1                       | 0.25                        | 20.5 <sup>+1.5</sup>      | 2                   | 0.8                     | 5.8                              |                           |
| 83263 | 24.3 | 0.5                     | 0.1                         | 20.5 <sup>+1.5</sup>      | 2                   | 0.8                     | 5.8                              |                           |
| 83264 | 24.3 | 0.25                    | 0.05                        | 20.5 <sup>+1.5</sup>      | 2                   | 0.8                     | 5.8                              |                           |
| 83265 | 24.3 | 0.13                    | 0.02                        | 20.5 <sup>+1.5</sup>      | 2                   | 0.8                     | 5.8                              |                           |
| 83268 | 24.3 | 0.5                     | 0.1                         | 20.5 <sup>+1.5</sup>      | 2                   | 0.8                     | 5.8                              |                           |
| 83269 | 24.3 | 0.13                    | 0.02                        | 20.5 <sup>+1.5</sup>      | 2                   | 0.8                     | 5.8                              |                           |

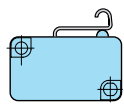

Lever 260G  
R13.8 Pos B

|       |      |      |      |                      |     |     |   |
|-------|------|------|------|----------------------|-----|-----|---|
| 83261 | 13.8 | 2    | 0.5  | 19.9 <sup>+0.7</sup> | 1.1 | 0.4 | 3 |
| 83262 | 13.8 | 2    | 0.5  | 19.9 <sup>+0.7</sup> | 1.1 | 0.4 | 3 |
| 83263 | 13.8 | 1    | 0.2  | 19.9 <sup>+0.7</sup> | 1.1 | 0.4 | 3 |
| 83264 | 13.8 | 0.5  | 0.1  | 19.9 <sup>+0.7</sup> | 1.1 | 0.4 | 3 |
| 83265 | 13.8 | 0.25 | 0.05 | 19.9 <sup>+0.7</sup> | 1.1 | 0.4 | 3 |
| 83268 | 13.8 | 1    | 0.2  | 19.9 <sup>+0.7</sup> | 1.1 | 0.4 | 3 |
| 83269 | 13.8 | 0.25 | 0.05 | 19.9 <sup>+0.7</sup> | 1.1 | 0.4 | 3 |

## Selection guide

| Actuators  | Rating / Force |            | 16 A / 2 N | 20 A / 2 N | 16 A / 1 N | 12 A / 0.5 N | 5 A / 0.25 N | 0.05 A / 1 N | 0.05 A / 0.25 N |
|--|----------------|------------|------------|------------|------------|--------------|--------------|--------------|-----------------|
|  | Function       | Connection | 83261      | 83262      | 83263      | 83264        | 83265        | 83268        | 83269           |
| <br>Plunger | I              | W1         | 83261001   | 83262001   | 83263001   | 83264001     | 83265001     | 83268001     | 83269001        |
|  | I              | W2         | 83261011   | 83262011   | 83263011   | 83264011     | 83265011     | 83268011     | 83269011        |
|  | I              | W3         | 83261021   | 83262021   | 83263021   | 83264021     | 83265021     | 83268021     | 83269021        |
|  | I              | W3R5       | 83261031   | 83262031   | 83263031   | 83264031     | 83265031     | 83268031     | 83269031        |
|  | I              | W6A5       | 83261041   | 83262041   | 83263041   | 83264041     | 83265041     | 83268041     | 83269041        |
|  | I              | W6D8       | 83261051   | 83262051   | 83263051   | 83264051     | 83265051     | 83268051     | 83269051        |
|  | I              | W7A5       | 83261061   | -          | 83263061   | 83264061     | 83265061     | 83268061     | 83269061        |
|  | I              | X2         | 83261071   | -          | 83263071   | 83264071     | 83265071     | 83268071     | 83269071        |
|  | I              | X3         | 83261081   | -          | 83263081   | 83264081     | 83265081     | 83268081     | 83269081        |
|  | I              | X1         | 83261091   | -          | 83263091   | 83264091     | 83265091     | 83268091     | 83269091        |
|  | R              | W1         | 83261601   | 83262601   | 83263601   | 83264601     | 83265601     | 83268601     | 83269601        |
|  | R              | W2         | 83261611   | 83262611   | 83263611   | 83264611     | 83265611     | 83268611     | 83269611        |
|  | R              | W3         | 83261621   | 83262621   | 83263621   | 83264621     | 83265621     | 83268621     | 83269621        |
|  | R              | W3R5       | 83261631   | 83262631   | 83263631   | 83264631     | 83265631     | 83268631     | 83269631        |
|  | R              | W6A5       | 83261641   | 83262641   | 83263641   | 83264641     | 83265641     | 83268641     | 83269641        |
|  | R              | W6D8       | 83261651   | 83262651   | 83263651   | 83264651     | 83265651     | 83268651     | 83269651        |
|  | R              | W7A5       | 83261661   | -          | 83263661   | 83264661     | 83265661     | 83268661     | 83269661        |
|  | C              | W1         | 83261801   | 83262801   | 83263801   | 83264801     | 83265801     | 83268801     | 83269801        |
|  | C              | W2         | 83261811   | 83262811   | 83263811   | 83264811     | 83265811     | 83268811     | 83269811        |
|  | C              | W3         | 83261821   | 83262821   | 83263821   | 83264821     | 83265821     | 83268821     | 83269821        |
| C  | W3R5           | 83261831   | 83262831   | 83263831   | 83264831   | 83265831     | 83268831     | 83269831     |                 |
| C  | W6A5           | 83261841   | 83262841   | 83263841   | 83264841   | 83265841     | 83268841     | 83269841     |                 |
| C  | W6D8           | 83261851   | 83262851   | 83263851   | 83264851   | 83265851     | 83268851     | 83269851     |                 |
| C  | W7A5           | 83261861   | -          | 83263861   | 83264861   | 83265861     | 83268861     | 83269861     |                 |

# Microswitches miniature V3D

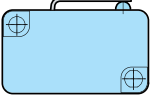
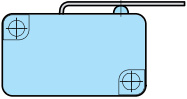
|   |          | Rating / Force | 16 A / 2 N | 20 A / 2 N | 16 A / 1 N | 12 A / 0.5 N | 5 A / 0.25 N | 0.05 A / 1 N | 0.05 A / 0.25 N |
|---|----------|----------------|------------|------------|------------|--------------|--------------|--------------|-----------------|
|   |          | Type           | 83261      | 83262      | 83263      | 83264        | 83265        | 83268        | 83269           |
| Actuators   | Function | Connection     |            |            |            |              |              |              |                 |
|  <p>Lever 260A<br/>R14.2 Pos B</p>   | I        | W1             | 83261002   | 83262002   | 83263002   | 83264002     | 83265002     | 83268002     | 83269002        |
|   | I        | W2             | 83261012   | 83262012   | 83263012   | 83264012     | 83265012     | 83268012     | 83269012        |
|   | I        | W3             | 83261022   | 83262022   | 83263022   | 83264022     | 83265022     | 83268022     | 83269022        |
|   | I        | W3R5           | 83261032   | 83262032   | 83263032   | 83264032     | 83265032     | 83268032     | 83269032        |
|   | I        | W6A5           | 83261042   | 83262042   | 83263042   | 83264042     | 83265042     | 83268042     | 83269042        |
|   | I        | W6D8           | 83261052   | 83262052   | 83263052   | 83264052     | 83265052     | 83268052     | 83269052        |
|   | I        | W7A5           | 83261062   | -          | 83263062   | 83264062     | 83265062     | 83268062     | 83269062        |
|   | I        | X2             | 83261072   | -          | 83263072   | 83264072     | 83265072     | 83268072     | 83269072        |
|   | I        | X3             | 83261082   | -          | 83263082   | 83264082     | 83265082     | 83268082     | 83269082        |
|   | I        | X1             | 83261092   | -          | 83263092   | 83264092     | 83265092     | 83268092     | 83269092        |
|   | R        | W1             | 83261602   | 83262602   | 83263602   | 83264602     | 83265602     | 83268602     | 83269602        |
|   | R        | W2             | 83261612   | 83262612   | 83263612   | 83264612     | 83265612     | 83268612     | 83269612        |
|   | R        | W3             | 83261622   | 83262622   | 83263622   | 83264622     | 83265622     | 83268622     | 83269622        |
|   | R        | W3R5           | 83261632   | 83262632   | 83263632   | 83264632     | 83265632     | 83268632     | 83269632        |
|   | R        | W6A5           | 83261642   | 83262642   | 83263642   | 83264642     | 83265642     | 83268642     | 83269642        |
|   | R        | W6D8           | 83261652   | 83262652   | 83263652   | 83264652     | 83265652     | 83268652     | 83269652        |
|   | R        | W7A5           | 83261662   | -          | 83263662   | 83264662     | 83265662     | 83268662     | 83269662        |
|   | C        | W1             | 83261802   | 83262802   | 83263802   | 83264802     | 83265802     | 83268802     | 83269802        |
|   | C        | W2             | 83261812   | 83262812   | 83263812   | 83264812     | 83265812     | 83268812     | 83269812        |
| C   | W3       | 83261822       | 83262822   | 83263822   | 83264822   | 83265822     | 83268822     | 83269822     |                 |
| C   | W3R5     | 83261832       | 83262832   | 83263832   | 83264832   | 83265832     | 83268832     | 83269832     |                 |
| C   | W6A5     | 83261842       | 83262842   | 83263842   | 83264842   | 83265842     | 83268842     | 83269842     |                 |
| C   | W6D8     | 83261852       | 83262852   | 83263852   | 83264852   | 83265852     | 83268852     | 83269852     |                 |
| C   | W7A5     | 83261862       | -          | 83263862   | 83264862   | 83265862     | 83268862     | 83269862     |                 |
|  <p>Lever 260A<br/>R25.4 Pos B</p> | I        | W1             | 83261003   | 83262003   | 83263003   | 83264003     | 83265003     | 83268003     | 83269003        |
|   | I        | W2             | 83261013   | 83262013   | 83263013   | 83264013     | 83265013     | 83268013     | 83269013        |
|   | I        | W3             | 83261023   | 83262023   | 83263023   | 83264023     | 83265023     | 83268023     | 83269023        |
|   | I        | W3R5           | 83261033   | 83262033   | 83263033   | 83264033     | 83265033     | 83268033     | 83269033        |
|   | I        | W6A5           | 83261043   | 83262043   | 83263043   | 83264043     | 83265043     | 83268043     | 83269043        |
|   | I        | W6D8           | 83261053   | 83262053   | 83263053   | 83264053     | 83265053     | 83268053     | 83269053        |
|   | I        | W7A5           | 83261063   | -          | 83263063   | 83264063     | 83265063     | 83268063     | 83269063        |
|   | I        | X2             | 83261073   | -          | 83263073   | 83264073     | 83265073     | 83268073     | 83269073        |
|   | I        | X3             | 83261083   | -          | 83263083   | 83264083     | 83265083     | 83268083     | 83269083        |
|   | I        | X1             | 83261093   | -          | 83263093   | 83264093     | 83265093     | 83268093     | 83269093        |
|   | R        | W1             | 83261603   | 83262603   | 83263603   | 83264603     | 83265603     | 83268603     | 83269603        |
|   | R        | W2             | 83261613   | 83262613   | 83263613   | 83264613     | 83265613     | 83268613     | 83269613        |
|   | R        | W3             | 83261623   | 83262623   | 83263623   | 83264623     | 83265623     | 83268623     | 83269623        |
|   | R        | W3R5           | 83261633   | 83262633   | 83263633   | 83264633     | 83265633     | 83268633     | 83269633        |
|   | R        | W6A5           | 83261643   | 83262643   | 83263643   | 83264643     | 83265643     | 83268643     | 83269643        |
|   | R        | W6D8           | 83261653   | 83262653   | 83263653   | 83264653     | 83265653     | 83268653     | 83269653        |
|   | R        | W7A5           | 83261663   | -          | 83263663   | 83264663     | 83265663     | 83268663     | 83269663        |
|   | C        | W1             | 83261803   | 83262803   | 83263803   | 83264803     | 83265803     | 83268803     | 83269803        |
|   | C        | W2             | 83261813   | 83262813   | 83263813   | 83264813     | 83265813     | 83268813     | 83269813        |
|   | C        | W3             | 83261823   | 83262823   | 83263823   | 83264823     | 83265823     | 83268823     | 83269823        |
|   | C        | W3R5           | 83261833   | 83262833   | 83263833   | 83264833     | 83265833     | 83268833     | 83269833        |
|   | C        | W6A5           | 83261843   | 83262843   | 83263843   | 83264843     | 83265843     | 83268843     | 83269843        |
|   | C        | W6D8           | 83261853   | 83262853   | 83263853   | 83264853     | 83265853     | 83268853     | 83269853        |
|   | C        | W7A5           | 83261863   | -          | 83263863   | 83264863     | 83265863     | 83268863     | 83269863        |

**Note:**

Function: **I** = Changeover - **R** = Normally closed - **C** = Normally open  
 Connection: **W1** = screws - **W2** = solder - **W3** = for 6.35 mm clips - **W3R5** = for Rast 5 connector  
**W6A5** = for 4.8 x 0.5 mm clips - **W6D8** = for 4.8 x 0.8 mm clips - **W7A5** = for 2.8 x 0.5 mm clips  
**X2** = rear side for PCB - **X3** = front side for PCB - **X1** = straight for PCB

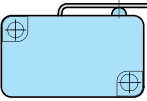
|  |          | Rating / Force | 16 A / 2 N | 20 A / 2 N | 16 A / 1 N | 12 A / 0.5N | 5 A / 0.25 N | 0.05 A / 1 N | 0.05 A / 0.25 N |
|--|----------|----------------|------------|------------|------------|-------------|--------------|--------------|-----------------|
|  |          | Type           | 83261      | 83262      | 83263      | 83264       | 83265        | 83268        | 83269           |
| Actuators  | Function | Connection     |            |            |            |             |              |              |                 |
| <br>Lever 260A<br>R40 Pos B | I        | W1             | 83261004   | 83262004   | 83263004   | 83264004    | 83265004     | 83268004     | 83269004        |
|  | I        | W2             | 83261014   | 83262014   | 83263014   | 83264014    | 83265014     | 83268014     | 83269014        |
|  | I        | W3             | 83261024   | 83262024   | 83263024   | 83264024    | 83265024     | 83268024     | 83269024        |
|  | I        | W3R5           | 83261034   | 83262034   | 83263034   | 83264034    | 83265034     | 83268034     | 83269034        |
|  | I        | W6A5           | 83261044   | 83262044   | 83263044   | 83264044    | 83265044     | 83268044     | 83269044        |
|  | I        | W6D8           | 83261054   | 83262054   | 83263054   | 83264054    | 83265054     | 83268054     | 83269054        |
|  | I        | W7A5           | 83261064   | -          | 83263064   | 83264064    | 83265064     | 83268064     | 83269064        |
|  | I        | X2             | 83261074   | -          | 83263074   | 83264074    | 83265074     | 83268074     | 83269074        |
|  | I        | X3             | 83261084   | -          | 83263084   | 83264084    | 83265084     | 83268084     | 83269084        |
|  | I        | X1             | 83261094   | -          | 83263094   | 83264094    | 83265094     | 83268094     | 83269094        |
|  | R        | W1             | 83261604   | 83262604   | 83263604   | 83264604    | 83265604     | 83268604     | 83269604        |
|  | R        | W2             | 83261614   | 83262614   | 83263614   | 83264614    | 83265614     | 83268614     | 83269614        |
|  | R        | W3             | 83261624   | 83262624   | 83263624   | 83264624    | 83265624     | 83268624     | 83269624        |
|  | R        | W3R5           | 83261634   | 83262634   | 83263634   | 83264634    | 83265634     | 83268634     | 83269634        |
|  | R        | W6A5           | 83261644   | 83262644   | 83263644   | 83264644    | 83265644     | 83268644     | 83269644        |
|  | R        | W6D8           | 83261654   | 83262654   | 83263654   | 83264654    | 83265654     | 83268654     | 83269654        |
|  | R        | W7A5           | 83261664   | -          | 83263664   | 83264664    | 83265664     | 83268664     | 83269664        |
|  | C        | W1             | 83261804   | 83262804   | 83263804   | 83264804    | 83265804     | 83268804     | 83269804        |
|  | C        | W2             | 83261814   | 83262814   | 83263814   | 83264814    | 83265814     | 83268814     | 83269814        |
|  | C        | W3             | 83261824   | 83262824   | 83263824   | 83264824    | 83265824     | 83268824     | 83269824        |
|  | I        | W1             | 83261005   | 83262005   | 83263005   | 83264005    | 83265005     | 83268005     | 83269005        |
|  | I        | W2             | 83261015   | 83262015   | 83263015   | 83264015    | 83265015     | 83268015     | 83269015        |
|  | I        | W3             | 83261025   | 83262025   | 83263025   | 83264025    | 83265025     | 83268025     | 83269025        |
|  | I        | W3R5           | 83261035   | 83262035   | 83263035   | 83264035    | 83265035     | 83268035     | 83269035        |
|  | I        | W6A5           | 83261045   | 83262045   | 83263045   | 83264045    | 83265045     | 83268045     | 83269045        |
|  | I        | W6D8           | 83261055   | 83262055   | 83263055   | 83264055    | 83265055     | 83268055     | 83269055        |
|  | I        | W7A5           | 83261065   | -          | 83263065   | 83264065    | 83265065     | 83268065     | 83269065        |
|  | I        | X2             | 83261075   | -          | 83263075   | 83264075    | 83265075     | 83268075     | 83269075        |
|  | I        | X3             | 83261085   | -          | 83263085   | 83264085    | 83265085     | 83268085     | 83269085        |
|  | I        | X1             | 83261095   | -          | 83263095   | 83264095    | 83265095     | 83268095     | 83269095        |
|  | R        | W1             | 83261605   | 83262605   | 83263605   | 83264605    | 83265605     | 83268605     | 83269605        |
|  | R        | W2             | 83261615   | 83262615   | 83263615   | 83264615    | 83265615     | 83268615     | 83269615        |
|  | R        | W3             | 83261625   | 83262625   | 83263625   | 83264625    | 83265625     | 83268625     | 83269625        |
|  | R        | W3R5           | 83261635   | 83262635   | 83263635   | 83264635    | 83265635     | 83268635     | 83269635        |
|  | R        | W6A5           | 83261645   | 83262645   | 83263645   | 83264645    | 83265645     | 83268645     | 83269645        |
|  | R        | W6D8           | 83261655   | 83262655   | 83263655   | 83264655    | 83265655     | 83268655     | 83269655        |
|  | R        | W7A5           | 83261665   | -          | 83263665   | 83264665    | 83265665     | 83268665     | 83269665        |
|  | C        | W1             | 83261805   | 83262805   | 83263805   | 83264805    | 83265805     | 83268805     | 83269805        |
|  | C        | W2             | 83261815   | 83262815   | 83263815   | 83264815    | 83265815     | 83268815     | 83269815        |
|  | C        | W3             | 83261825   | 83262825   | 83263825   | 83264825    | 83265825     | 83268825     | 83269825        |
|  | C        | W3R5           | 83261835   | 83262835   | 83263835   | 83264835    | 83265835     | 83268835     | 83269835        |
|  | C        | W6A5           | 83261845   | 83262845   | 83263845   | 83264845    | 83265845     | 83268845     | 83269845        |
|  | C        | W6D8           | 83261855   | 83262855   | 83263855   | 83264855    | 83265855     | 83268855     | 83269855        |
|  | C        | W7A5           | 83261865   | -          | 83263865   | 83264865    | 83265865     | 83268865     | 83269865        |

**Note:**

Function: **I** = Changeover - **R** = Normally closed - **C** = Normally open

Connection: **W1** = screws - **W2** = solder - **W3** = for 6.35 mm clips - **W3R5** = for Rast 5 connector

**W6A5** = for 4.8 x 0.5 mm clips - **W6D8** = for 4.8 x 0.8 mm clips - **W7A5** = for 2.8 x 0.5 mm clips

**X2** = rear side for PCB - **X3** = front side for PCB - **X1** = straight for PCB

# Microswitches miniature V3D

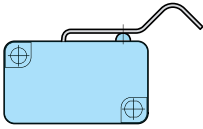
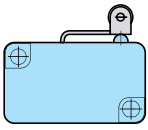
|   |          | Rating / Force |          | 16 A / 2 N | 20 A / 2 N | 16 A / 1 N | 12 A / 0.5 N | 5 A / 0.25 N | 0.05 A / 1 N | 0.05 A / 0.25 N |
|---|----------|----------------|----------|------------|------------|------------|--------------|--------------|--------------|-----------------|
|   |          | Type           |          | 83261      | 83262      | 83263      | 83264        | 83265        | 83268        | 83269           |
| Actuators   | Function | Connection     |          |            |            |            |              |              |              |                 |
|  <p>Lever 260F<br/>R22.2 Pos B</p>   | I        | W1             | 83261006 | 83262006   | 83263006   | 83264006   | 83265006     | 83268006     | 83269006     |                 |
|   | I        | W2             | 83261016 | 83262016   | 83263016   | 83264016   | 83265016     | 83268016     | 83269016     |                 |
|   | I        | W3             | 83261026 | 83262026   | 83263026   | 83264026   | 83265026     | 83268026     | 83269026     |                 |
|   | I        | W3R5           | 83261036 | 83262036   | 83263036   | 83264036   | 83265036     | 83268036     | 83269036     |                 |
|   | I        | W6A5           | 83261046 | 83262046   | 83263046   | 83264046   | 83265046     | 83268046     | 83269046     |                 |
|   | I        | W6D8           | 83261056 | 83262056   | 83263056   | 83264056   | 83265056     | 83268056     | 83269056     |                 |
|   | I        | W7A5           | 83261066 | -          | 83263066   | 83264066   | 83265066     | 83268066     | 83269066     |                 |
|   | I        | X2             | 83261076 | -          | 83263076   | 83264076   | 83265076     | 83268076     | 83269076     |                 |
|   | I        | X3             | 83261086 | -          | 83263086   | 83264086   | 83265086     | 83268086     | 83269086     |                 |
|   | I        | X1             | 83261096 | -          | 83263096   | 83264096   | 83265096     | 83268096     | 83269096     |                 |
|   | R        | W1             | 83261606 | 83262606   | 83263606   | 83264606   | 83265606     | 83268606     | 83269606     |                 |
|   | R        | W2             | 83261616 | 83262616   | 83263616   | 83264616   | 83265616     | 83268616     | 83269616     |                 |
|   | R        | W3             | 83261626 | 83262626   | 83263626   | 83264626   | 83265626     | 83268626     | 83269626     |                 |
|   | R        | W3R5           | 83261636 | 83262636   | 83263636   | 83264636   | 83265636     | 83268636     | 83269636     |                 |
|   | R        | W6A5           | 83261646 | 83262646   | 83263646   | 83264646   | 83265646     | 83268646     | 83269646     |                 |
|   | R        | W6D8           | 83261656 | 83262656   | 83263656   | 83264656   | 83265656     | 83268656     | 83269656     |                 |
|   | R        | W7A5           | 83261666 | -          | 83263666   | 83264666   | 83265666     | 83268666     | 83269666     |                 |
|   | C        | W1             | 83261806 | 83262806   | 83263806   | 83264806   | 83265806     | 83268806     | 83269806     |                 |
|   | C        | W2             | 83261816 | 83262816   | 83263816   | 83264816   | 83265816     | 83268816     | 83269816     |                 |
| C   | W3       | 83261826       | 83262826 | 83263826   | 83264826   | 83265826   | 83268826     | 83269826     |              |                 |
| C   | W3R5     | 83261836       | 83262836 | 83263836   | 83264836   | 83265836   | 83268836     | 83269836     |              |                 |
| C   | W6A5     | 83261846       | 83262846 | 83263846   | 83264846   | 83265846   | 83268846     | 83269846     |              |                 |
| C   | W6D8     | 83261856       | 83262856 | 83263856   | 83264856   | 83265856   | 83268856     | 83269856     |              |                 |
| C   | W7A5     | 83261866       | -        | 83263866   | 83264866   | 83265866   | 83268866     | 83269866     |              |                 |
|  <p>Lever 260E<br/>R13.7 Pos B</p> | I        | W1             | 83261007 | 83262007   | 83263007   | 83264007   | 83265007     | 83268007     | 83269007     |                 |
|   | I        | W2             | 83261017 | 83262017   | 83263017   | 83264017   | 83265017     | 83268017     | 83269017     |                 |
|   | I        | W3             | 83261027 | 83262027   | 83263027   | 83264027   | 83265027     | 83268027     | 83269027     |                 |
|   | I        | W3R5           | 83261037 | 83262037   | 83263037   | 83264037   | 83265037     | 83268037     | 83269037     |                 |
|   | I        | W6A5           | 83261047 | 83262047   | 83263047   | 83264047   | 83265047     | 83268047     | 83269047     |                 |
|   | I        | W6D8           | 83261057 | 83262057   | 83263057   | 83264057   | 83265057     | 83268057     | 83269057     |                 |
|   | I        | W7A5           | 83261067 | -          | 83263067   | 83264067   | 83265067     | 83268067     | 83269067     |                 |
|   | I        | X2             | 83261077 | -          | 83263077   | 83264077   | 83265077     | 83268077     | 83269077     |                 |
|   | I        | X3             | 83261087 | -          | 83263087   | 83264087   | 83265087     | 83268087     | 83269087     |                 |
|   | I        | X1             | 83261097 | -          | 83263097   | 83264097   | 83265097     | 83268097     | 83269097     |                 |
|   | R        | W1             | 83261607 | 83262607   | 83263607   | 83264607   | 83265607     | 83268607     | 83269607     |                 |
|   | R        | W2             | 83261617 | 83262617   | 83263617   | 83264617   | 83265617     | 83268617     | 83269617     |                 |
|   | R        | W3             | 83261627 | 83262627   | 83263627   | 83264627   | 83265627     | 83268627     | 83269627     |                 |
|   | R        | W3R5           | 83261637 | 83262637   | 83263637   | 83264637   | 83265637     | 83268637     | 83269637     |                 |
|   | R        | W6A5           | 83261647 | 83262647   | 83263647   | 83264647   | 83265647     | 83268647     | 83269647     |                 |
|   | R        | W6D8           | 83261657 | 83262657   | 83263657   | 83264657   | 83265657     | 83268657     | 83269657     |                 |
|   | R        | W7A5           | 83261667 | -          | 83263667   | 83264667   | 83265667     | 83268667     | 83269667     |                 |
|   | C        | W1             | 83261807 | 83262807   | 83263807   | 83264807   | 83265807     | 83268807     | 83269807     |                 |
|   | C        | W2             | 83261817 | 83262817   | 83263817   | 83264817   | 83265817     | 83268817     | 83269817     |                 |
|   | C        | W3             | 83261827 | 83262827   | 83263827   | 83264827   | 83265827     | 83268827     | 83269827     |                 |
|   | C        | W3R5           | 83261837 | 83262837   | 83263837   | 83264837   | 83265837     | 83268837     | 83269837     |                 |
|   | C        | W6A5           | 83261847 | 83262847   | 83263847   | 83264847   | 83265847     | 83268847     | 83269847     |                 |
|   | C        | W6D8           | 83261857 | 83262857   | 83263857   | 83264857   | 83265857     | 83268857     | 83269857     |                 |
|   | C        | W7A5           | 83261867 | -          | 83263867   | 83264867   | 83265867     | 83268867     | 83269867     |                 |

**Note:**

Function: **I** = Changeover - **R** = Normally closed - **C** = Normally open  
 Connection: **W1** = screws - **W2** = solder - **W3** = for 6.35 mm clips - **W3R5** = for Rast 5 connector  
**W6A5** = for 4.8 x 0.5 mm clips - **W6D8** = for 4.8 x 0.8 mm clips - **W7A5** = for 2.8 x 0.5 mm clips  
**X2** = rear side for PCB - **X3** = front side for PCB - **X1** = straight for PCB

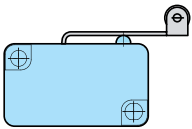
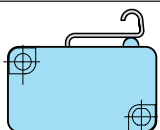
|   |          | Rating / Force | 16 A / 2 N | 20 A / 2 N | 16 A / 1 N | 12 A / 0.5 N | 5 A / 0.25 N | 0.05 A / 1 N | 0.05 A / 0.25 N |
|---|----------|----------------|------------|------------|------------|--------------|--------------|--------------|-----------------|
|   |          | Type           | 83261      | 83262      | 83263      | 83264        | 83265        | 83268        | 83269           |
| Actuators   | Function | Connection     |            |            |            |              |              |              |                 |
|  <p>Lever 260E<br/>R24.3 Pos B</p>   | I        | W1             | 83261008   | 83262008   | 83263008   | 83264008     | 83265008     | 83268008     | 83269008        |
|   | I        | W2             | 83261018   | 83262018   | 83263018   | 83264018     | 83265018     | 83268018     | 83269018        |
|   | I        | W3             | 83261028   | 83262028   | 83263028   | 83264028     | 83265028     | 83268028     | 83269028        |
|   | I        | W3R5           | 83261038   | 83262038   | 83263038   | 83264038     | 83265038     | 83268038     | 83269038        |
|   | I        | W6A5           | 83261048   | 83262048   | 83263048   | 83264048     | 83265048     | 83268048     | 83269048        |
|   | I        | W6D8           | 83261058   | 83262058   | 83263058   | 83264058     | 83265058     | 83268058     | 83269058        |
|   | I        | W7A5           | 83261068   | -          | 83263068   | 83264068     | 83265068     | 83268068     | 83269068        |
|   | I        | X2             | 83261078   | -          | 83263078   | 83264078     | 83265078     | 83268078     | 83269078        |
|   | I        | X3             | 83261088   | -          | 83263088   | 83264088     | 83265088     | 83268088     | 83269088        |
|   | I        | X1             | 83261098   | -          | 83263098   | 83264098     | 83265098     | 83268098     | 83269098        |
|   | R        | W1             | 83261608   | 83262608   | 83263608   | 83264608     | 83265608     | 83268608     | 83269608        |
|   | R        | W2             | 83261618   | 83262618   | 83263618   | 83264618     | 83265618     | 83268618     | 83269618        |
|   | R        | W3             | 83261628   | 83262628   | 83263628   | 83264628     | 83265628     | 83268628     | 83269628        |
|   | R        | W3R5           | 83261638   | 83262638   | 83263638   | 83264638     | 83265638     | 83268638     | 83269638        |
|   | R        | W6A5           | 83261648   | 83262648   | 83263648   | 83264648     | 83265648     | 83268648     | 83269648        |
|   | R        | W6D8           | 83261658   | 83262658   | 83263658   | 83264658     | 83265658     | 83268658     | 83269658        |
|   | R        | W7A5           | 83261668   | -          | 83263668   | 83264668     | 83265668     | 83268668     | 83269668        |
|   | C        | W1             | 83261808   | 83262808   | 83263808   | 83264808     | 83265808     | 83268808     | 83269808        |
|   | C        | W2             | 83261818   | 83262818   | 83263818   | 83264818     | 83265818     | 83268818     | 83269818        |
| C   | W3       | 83261828       | 83262828   | 83263828   | 83264828   | 83265828     | 83268828     | 83269828     |                 |
| C   | W3R5     | 83261838       | 83262838   | 83263838   | 83264838   | 83265838     | 83268838     | 83269838     |                 |
| C   | W6A5     | 83261848       | 83262848   | 83263848   | 83264848   | 83265848     | 83268848     | 83269848     |                 |
| C   | W6D8     | 83261858       | 83262858   | 83263858   | 83264858   | 83265858     | 83268858     | 83269858     |                 |
| C   | W7A5     | 83261868       | -          | 83263868   | 83264868   | 83265868     | 83268868     | 83269868     |                 |
|  <p>Lever 260G<br/>R13.8 Pos B</p> | I        | W1             | 83261009   | 83262009   | 83263009   | 83264009     | 83265009     | 83268009     | 83269009        |
|   | I        | W2             | 83261019   | 83262019   | 83263019   | 83264019     | 83265019     | 83268019     | 83269019        |
|   | I        | W3             | 83261029   | 83262029   | 83263029   | 83264029     | 83265029     | 83268029     | 83269029        |
|   | I        | W3R5           | 83261039   | 83262039   | 83263039   | 83264039     | 83265039     | 83268039     | 83269039        |
|   | I        | W6A5           | 83261049   | 83262049   | 83263049   | 83264049     | 83265049     | 83268049     | 83269049        |
|   | I        | W6D8           | 83261059   | 83262059   | 83263059   | 83264059     | 83265059     | 83268059     | 83269059        |
|   | I        | W7A5           | 83261069   | -          | 83263069   | 83264069     | 83265069     | 83268069     | 83269069        |
|   | I        | X2             | 83261079   | -          | 83263079   | 83264079     | 83265079     | 83268079     | 83269079        |
|   | I        | X3             | 83261089   | -          | 83263089   | 83264089     | 83265089     | 83268089     | 83269089        |
|   | I        | X1             | 83261099   | -          | 83263099   | 83264099     | 83265099     | 83268099     | 83269099        |
|   | R        | W1             | 83261609   | 83262609   | 83263609   | 83264609     | 83265609     | 83268609     | 83269609        |
|   | R        | W2             | 83261619   | 83262619   | 83263619   | 83264619     | 83265619     | 83268619     | 83269619        |
|   | R        | W3             | 83261629   | 83262629   | 83263629   | 83264629     | 83265629     | 83268629     | 83269629        |
|   | R        | W3R5           | 83261639   | 83262639   | 83263639   | 83264639     | 83265639     | 83268639     | 83269639        |
|   | R        | W6A5           | 83261649   | 83262649   | 83263649   | 83264649     | 83265649     | 83268649     | 83269649        |
|   | R        | W6D8           | 83261659   | 83262659   | 83263659   | 83264659     | 83265659     | 83268659     | 83269659        |
|   | R        | W7A5           | 83261669   | -          | 83263669   | 83264669     | 83265669     | 83268669     | 83269669        |
|   | C        | W1             | 83261809   | 83262809   | 83263809   | 83264809     | 83265809     | 83268809     | 83269809        |
|   | C        | W2             | 83261819   | 83262819   | 83263819   | 83264819     | 83265819     | 83268819     | 83269819        |
| C   | W3       | 83261829       | 83262829   | 83263829   | 83264829   | 83265829     | 83268829     | 83269829     |                 |
| C   | W3R5     | 83261839       | 83262839   | 83263839   | 83264839   | 83265839     | 83268839     | 83269839     |                 |
| C   | W6A5     | 83261849       | 83262849   | 83263849   | 83264849   | 83265849     | 83268849     | 83269849     |                 |
| C   | W6D8     | 83261859       | 83262859   | 83263859   | 83264859   | 83265859     | 83268859     | 83269859     |                 |
| C   | W7A5     | 83261869       | -          | 83263869   | 83264869   | 83265869     | 83268869     | 83269869     |                 |

**Note:**

Function: **I** = Changeover - **R** = Normally closed - **C** = Normally open

Connection: **W1** = screws - **W2** = solder - **W3** = for 6.35 mm clips - **W3R5** = for Rast 5 connector

**W6A5** = for 4.8 x 0.5 mm clips - **W6D8** = for 4.8 x 0.8 mm clips - **W7A5** = for 2.8 x 0.5 mm clips

**X2** = rear side for PCB - **X3** = front side for PCB - **X1** = straight for PCB



## AMERICA

### BRAZIL

**Custom Sensors & Technologies**  
**Crouzet Latinoamerica**  
 Alameda Rio Negro  
 1084 - cj.A31  
 CEP 06454-000 - Alphaville - SP BRASIL  
 Tel. : +55 (11) 4191 9797  
 Fax : +55 (11) 4191 9136  
 E-mail : info@cst-latinoamerica.com  
 www.crouzet.com.br  
 www.cst-latinoamerica.com

### USA/CANADA/MEXICO

**Custom Sensors & Technologies - Crouzet**  
 7230 Hollister Avenue  
 Goleta, CA, 93117  
 USA  
 Tel. : +1 (800) 677 5311  
 Fax : +1 (800) 677 3865  
 E-mail : customer.service@us.crouzet.com  
 www.crouzet.com

### OTHER COUNTRIES

**Custom Sensors & Technologies**  
**Crouzet Latinoamerica**  
 Alameda Rio Negro  
 1084 - cj.A31  
 CEP 06454-000 - Alphaville - SP BRASIL  
 Tel. : +55 (11) 4191 9797  
 Fax : +55 (11) 4191 9136  
 E-mail : info@cst-latinoamerica.com  
 www.crouzet.com.br  
 www.cst-latinoamerica.com

## EUROPE MIDDLE EAST AFRICA

### AUSTRIA

**Crouzet GmbH**  
 Zweigniederlassung Österreich  
 Spengergasse 1/3  
 1050 Wien  
 ÖSTERREICH  
 Tel. : +43 (0) 1 36 85 471  
 Fax : +43 (0) 1 36 85 472  
 E-mail : info-direkt@crouzet.com  
 www.crouzet.at

### BELGIUM

**Crouzet NV/SA**  
 Dieweg 3 B  
 B - 1180 Uccle  
 BELGIUM  
 Tel. : +32 (0) 2 462 07 30  
 Fax : +32 (0) 2 461 00 23  
 E-mail : com-be@crouzet.com  
 www.crouzet.be

Creation-Design: 3C Evolution, Crouzet Automatismes  
 Editing-Publishing: 3C Evolution  
 Photos-Graphics: Ginko, Daniel Lattard, Schneider Electric  
 Printing:

### FRANCE

**Crouzet Automatismes SAS**  
 2 rue du Docteur Abel - BP 59  
 26902 Valence CEDEX 9  
 FRANCE  
 Tel. : +33 (0) 4 75 44 88 44  
 Fax : +33 (0) 4 75 55 98 03  
 E-mail : com-fr@crouzet.com  
 www.crouzet.fr

### Customer service

**Indigo** 0 825 333 351

**Azur FAX** 0 810 610 102

### GERMANY

**Crouzet GmbH**  
 Otto-Hahn-Str. 3, 40721 Hilden  
 Postfach 203, 40702 Hilden  
 DEUTSCHLAND  
 Tel. : +49 (0) 21 03 9 80-171  
 Fax : +49 (0) 21 03 9 80-222  
 E-mail : info-direkt@crouzet.com  
 www.crouzet.de

### ITALY

**Crouzet Componenti s.r.l.**  
 Via Viganò De Vizzi, 93/95  
 20092 Cinisello Balsamo (MI)  
 ITALIA  
 Tel. : +39 (02) 66 599 250  
 Fax : +39 (02) 66 599 258  
 E-mail : crz-it-sensori-micro@crouzet.com  
 www.crouzet.it

### SPAIN/PORTUGAL

**Crouzet Ibérica**  
 C/ Aragón 224, 2º 2ª  
 08011 Barcelona  
 ESPAÑA  
 Tel. : +34 (93) 484 39 70  
 Fax : +34 (93) 484 39 73  
 E-mail : es-consultas@crouzet.es  
 www.crouzet.es

### THE NETHERLANDS

**Crouzet BV**  
 Industrieweg 17  
 2382 NR Zoeterwoude  
 NEDERLAND  
 Tel. : +31 (0) 71-581 20 30  
 Fax : +31 (0) 71-541 35 74  
 E-mail : com-nl@crouzet.com  
 www.crouzet.nl

### UNITED KINGDOM

**Crouzet Ltd**  
 8 Cedarwood  
 Chineham Business Park  
 Crockford Lane  
 Basingstoke, Hampshire  
 RG24 8WD  
 UNITED KINGDOM  
 Tel. : +44 (0)1256 318 900  
 Fax : +44 (0)1256 318 901  
 E-mail : info@crouzet.co.uk  
 www.crouzet.co.uk

### SWITZERLAND

**Crouzet AG**  
 Gewerbepark - Postfach 56  
 5506 Mägenwil  
 SCHWEIZ  
 Tel. : +41(0) 62 887 30 30  
 Fax : +41(0) 62 887 30 40  
 E-mail : info-direkt@crouzet.com  
 www.crouzet.ch

### OTHER COUNTRIES

**Crouzet Automatismes SAS**  
 2 rue du Docteur Abel - BP 59  
 26902 Valence CEDEX 9  
 FRANCE  
 Tel. : +33 (0) 475 802 102  
 Fax : +33 (0) 475 448 126  
 E-mail : com-ex@crouzet.com  
 www.crouzet.com

## ASIA PACIFIC

### CHINA & HONG KONG

**Custom Sensors & Technologies Asia (Shanghai) Limited - Crouzet**  
 2 Floor, Innovation Building  
 No. 1009, Yi Shan Road  
 Shanghai 200233  
 CHINA  
 Tel. : +86 (21) 2401 7766  
 Fax : +86 (21) 6249 0701  
 E-mail : china@cstsensors.com  
 www.crouzet.cn  
 www.cstsensors.com

### INDIA

**Custom Sensors & Technologies - Crouzet**  
 Prestige Meridian II  
 No. 30, 13th Floor,  
 Unit No: 1301 & 1302  
 Mahatma Gandhi Road  
 Bangalore 560 001  
 INDIA  
 Tel. : +91 (0) 80 4113 2204/05  
 Fax : +91 (0) 80 4113 2206  
 E-mail : crz\_bangalore@crouzet.com  
 www.crouzet.co.in  
 www.cstsensors.com

### TAIWAN

**Custom Sensors & Technologies - Crouzet**  
 3F, No. 39, Ji-Hu Road  
 Nei-Hu Dist. - Taipei 114  
 TAIWAN  
 Tel. : +886 (0)2 8751 6388  
 Fax : +886 (0)2 2657 8725  
 E-mail : taiwan@cstsensors.com  
 www.crouzet.tw  
 www.cstsensors.com

### KOREA & JAPAN

**Custom Sensors & Technologies - Crouzet**  
 5F, Jeil Bldg,  
 94-46 Youngdeungpo-dong  
 7-ga Youngdeungpo-gu  
 Seoul 150-037  
 SOUTH KOREA  
 Tel. : +82 (0)2 2629 8312  
 Fax : +82 (0)2 2629 8310  
 E-mail : korea@cstsensors.com  
 www.crouzet.tw  
 www.cstsensors.com

### SOUTH EAST ASIA & PACIFIC

**Custom Sensors & Technologies - Crouzet**  
 3F, No. 39, Ji-Hu Road  
 Nei-Hu Dist. - Taipei 114  
 TAIWAN  
 Tel. : +886 (0)2 8751 6388  
 Fax : +886 (0)2 2657 8725  
 E-mail : eap@cstsensors.com  
 www.crouzet.tw  
 www.cstsensors.com

**Warning:**  
 The product information contained in this catalogue is given purely as information and does not constitute a representation, warranty or any form of contractual commitment. CROUZET Automatismes and its subsidiaries reserve the right to modify their products without notice. It is imperative that we should be consulted over any particular use or application of our products and it is the responsibility of the buyer to establish, particularly through all the appropriate tests, that the product is suitable for the use or application. Under no circumstances will our warranty apply, nor shall we be held responsible for any application (such as any modification, addition, deletion, use in conjunction with other electrical or electronic components, circuits or assemblies, or any other unsuitable material or substance) which has not been expressly agreed by us prior to the sale of our products.

Headquartered in Moorpark, California-USA, **Custom Sensors & Technologies (CST)** is made up of the leading brands of Crouzet, Kavlico and Crydom, as well as the former divisions of BEI Technologies, including Newall and Systron Donner. CST provides sensors, controls, and actuation products to the transportation, industrial, and aerospace & defense markets.

[www.cstsensors.com](http://www.cstsensors.com)

Distributed by:

### Crouzet Automatismes SAS

2 rue du Docteur Abel - BP 59  
 26902 Valence CEDEX 9  
 FRANCE

[www.crouzet.com](http://www.crouzet.com)





Компания «ЭлектроПласт» предлагает заключение долгосрочных отношений при поставках импортных электронных компонентов на взаимовыгодных условиях!

Наши преимущества:

- Оперативные поставки широкого спектра электронных компонентов отечественного и импортного производства напрямую от производителей и с крупнейших мировых складов;
- Поставка более 17-ти миллионов наименований электронных компонентов;
- Поставка сложных, дефицитных, либо снятых с производства позиций;
- Оперативные сроки поставки под заказ (от 5 рабочих дней);
- Экспресс доставка в любую точку России;
- Техническая поддержка проекта, помощь в подборе аналогов, поставка прототипов;
- Система менеджмента качества сертифицирована по Международному стандарту ISO 9001;
- Лицензия ФСБ на осуществление работ с использованием сведений, составляющих государственную тайну;
- Поставка специализированных компонентов (Xilinx, Altera, Analog Devices, Intersil, Interpoint, Microsemi, Aeroflex, Peregrine, Syfer, Eurofarad, Texas Instrument, Miteq, Cobham, E2V, MA-COM, Hittite, Mini-Circuits, General Dynamics и др.);

Помимо этого, одним из направлений компании «ЭлектроПласт» является направление «Источники питания». Мы предлагаем Вам помощь Конструкторского отдела:

- Подбор оптимального решения, техническое обоснование при выборе компонента;
- Подбор аналогов;
- Консультации по применению компонента;
- Поставка образцов и прототипов;
- Техническая поддержка проекта;
- Защита от снятия компонента с производства.



#### Как с нами связаться

**Телефон:** 8 (812) 309 58 32 (многоканальный)

**Факс:** 8 (812) 320-02-42

**Электронная почта:** [org@eplast1.ru](mailto:org@eplast1.ru)

**Адрес:** 198099, г. Санкт-Петербург, ул. Калинина, дом 2, корпус 4, литера А.