

Plug and Header Systems

3.5mm Pitch



ELXP Right Angle Page 15
 ELXP with Locking Ears . . . Page 17
12A / 300V

3.5mm Pitch



ELXT Straight Page 15
 ELXT with Locking Ears . . . Page 17
12A / 300V

PLUGS 3.5MM PITCH

.150" Pitch



ELVP Right Angle Page 19
 ELVP with Locking Ears . . . Page 21
12A / 300V

.150" Pitch



ELVT Straight Page 17
 ELVT—Locking Ears Page 19
12A / 300V

PLUGS .150" PITCH . . .

.150" Pitch



ELVF Front-Front Page 19
 ELVF with Locking Ears . . . Page 21
12A / 300V

.150" Pitch



SCVF Spring Clamp Page 82
 SCVF with Locking Ears . . . Page 83
12A / 300V

. . . PLUGS .150" PITCH

5.0mm Pitch



ELFP Right Angle Page 28
 ELFP with Locking Ears . . . Page 30
15A / 300V

5.0mm Pitch

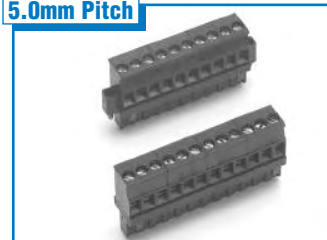

ELFT—Straight Page 28
 ELFT with Locking Ears . . . Page 30
15A / 300V

PLUGS 5.0MM PITCH . . .

5.0mm Pitch



ELFF Front-Front Page 29
 ELFF with Locking Ears . . . Page 31
15A / 300V

5.0mm Pitch



ESZP Compact Page 37
12A / 250V

. . . PLUGS 5.0MM PITCH

5.0mm Pitch



ELFP-P Wire Support Plug . Page 27
15A / 300V

.200" Pitch



ELFP Right Angle Page 38
 ELFP with Locking Ears . . . Page 40
15A / 300V

PLUGS .200" PITCH

.200" Pitch



ELFT Straight Page 38
 ELFT with Locking Ears . . . Page 40
15A / 300V

.200" Pitch



ELFF—Standard Page 39
 ELFF—Locking Ears Page 41
15A / 300V

. . . PLUGS .200" PITCH . . .

.200" Pitch

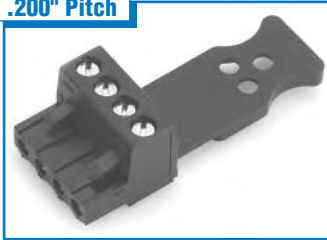

ELFP-P Wire Support Plug . Page 27
15A / 300V

.200" Pitch

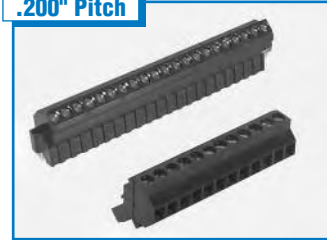

ELFK 45° Angle Page 39
 ELFK w/ Locking Ears Page 41
15A / 300V

.200" Pitch



FXP FlexiPlug® Page 42
Euro/Screw-clamp Hybrid
15A / 300V

.200" Pitch



ELFB Board-Mount Page 47
15A / 300V

.200" Pitch



SCFF Spring Clamp Page 79
15A / 300V

.300" Pitch



ELFP Right Angle Page 50
ELFP with Locking Ears . . . Page 50
15A / 300V

. . . PLUGS .200" PITCH

PLUGS .300" PITCH . . .

.300" Pitch



ELFT Straight Page 51
ELFT with Locking Ears . . . Page 51
15A / 300V

10mm /.400"

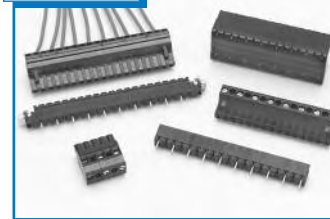

ELLP, ELLT, ELLF, ELLK . . . Page 53
15A / 600V

3.5mm Pitch

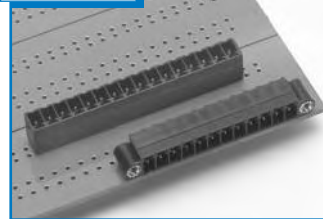

ELXH Headers Hor/Ver . . . Page 14
ELXH with Locking Ears . . . Page 16
12A / 300V

.150" Pitch

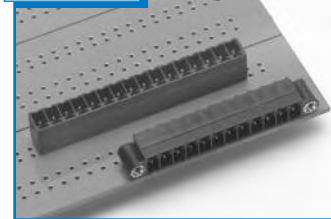

ELVH Headers Hor/Ver . . . Page 18
ELVH with Locking Ears . . . Page 20
12A / 300V

. . . PLUGS .300" PITCH

PLUGS 10.0MM/.400"

HEADERS 3.5MM PITCH

HEADERS .150" PITCH . . .

.150" Pitch



ELVD 2-Tier Offset H/V . . . Page 22
12A / 300V

.150" Pitch

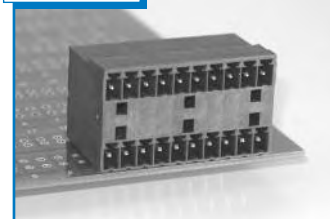

ELVA 2-Tier Aligned H/V . . . Page 23
12A / 300V

5.0mm Pitch



ELFH Closed Ends Hor/Ver
ELFH Open Ends Hor/Ver . . Page 33
15A / 300V

5.0mm Pitch

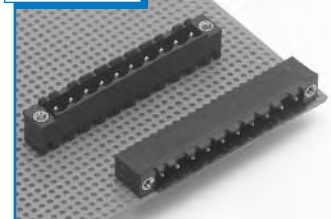

ELFH with Locking Ears . . . Page 32
15A / 300V

. . . HEADERS .150" PITCH

HEADERS 5.0MM PITCH . . .

5.0mm Pitch

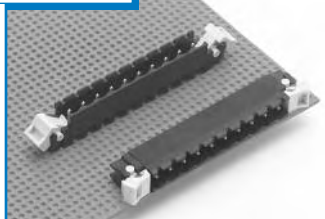

ELFH with Ejector Ears . . . Page 34
15A / 300V

5.0mm Pitch

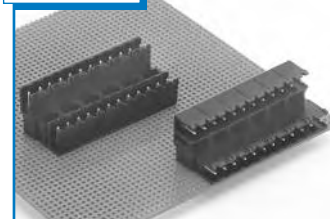

ELFD 2-Tier Offset H/V . . . Page 35
12A / 300V

5.0mm Pitch

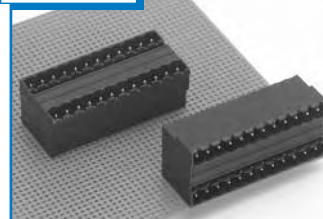

ELFA 2-Tier Aligned H/V . . . Page 36
15A / 300V

5.0mm Pitch

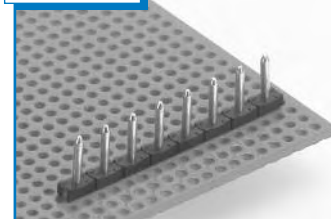

ESZH Pin Header Page 37
12A / 250V

. . . HEADERS 5.0MM PITCH



.200" Pitch
ELFH Closed Ends Hor/Ver
ELFH Open Ends Hor/Ver . . . Page 45
15A / 300V



.200" Pitch
ELFH with Locking Ears . . . Page 44
15A / 300V



.200" Pitch
ELFH with Ejector Ears . . . Page 46
15A / 300V



.200" Pitch
ELFB Inverted Header Page 47
15A / 300V

. . . HEADERS .200" PITCH



.200" Pitch
ELFD 2-Tier Offset H/V Page 48
15A / 300V



.200" Pitch
ELFA 2-Tier Aligned H/V . . . Page 49
15A / 300V



.300" Pitch
ELFH Closed Ends Hor/Ver
ELFH with Locking Ears . . . Page 50
15A / 300V



10mm / .400"
ELLH Page 53
15A / 600V

. . . HEADERS .200" PITCH

HEADERS .300" PITCH

HEADERS 10MM/.400"



.100" Pitch
ESDM Ultra-Miniature Page 55
10A / 150V



3.5mm Pitch
ESBM Low-Profile Page 58
12A / 150V



3.5mm Pitch
ELXM Page 61
12A / 300V



3.5mm Pitch
SMXM Surface-Mount . . Page 56-57
12A / 300V

FIXED BLOCKS .100"

FIXED BLOCKS 3.5MM PITCH



.150" Pitch
ESBM Low-Profile Page 58
12A / 150V



.150" Pitch
ELVM Page 60
12A / 300V



.150" Pitch
SMVM Surface-Mount . . Page 56-57
12A / 300V



.150" Pitch
EL3V 3-Tier Page 59
12A / 300V

FIXED BLOCKS .150" PITCH

Fixed Terminal Blocks



5.0mm Pitch
ELM Standard Profiles Page 63
15A / 300V



5.0mm Pitch
ESLM Low-Profile, R/A . . . Page 65
13.5A / 300V



5.0mm Pitch
ESLT Multi-tier Pages 68-69
13.5A / 300V



5.0mm Pitch
ESMT Multi-tier Pages 70-71
17.5A / 300V

FIXED BLOCKS 5.0MM PITCH . . .

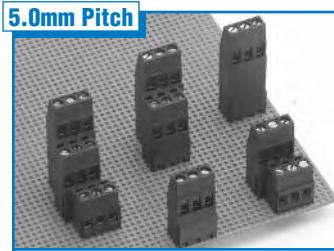

5.0mm Pitch
ESTT Multi-tier Pages 72-73
24A / 300V



5.0mm Pitch
SCM Spring-Clamp Page 81
20A / 300V



.200" Pitch
ELM Standard Profiles Page 62
15A / 300V



.200" Pitch
ELMM Low-Profile, Angled. Page 64
15A / 300V

. . . FIXED BLOCKS 5.0MM PITCH

FIXED BLOCKS .200" PITCH . . .

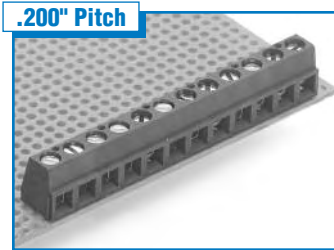

.200" Pitch
ESLM Low-Profile, R/A . . . Page 65
13.5A / 300V



.200" Pitch
ESLT Multi-tier Pages 68-69
13.5A / 300V



.200" Pitch
ESMT Multi-tier Pages 70-71
17.5A / 300V



.200" Pitch
ESTT Multi-tier Pages 72-73
24A / 300V

. . . FIXED BLOCKS .200" PITCH . . .

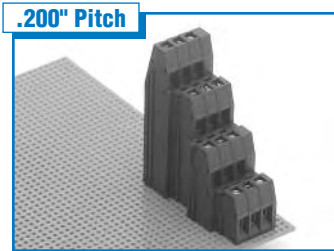

.200" Pitch
ESTT 4-tier Page 67
24A / 300V



.200" Pitch
EL1M /2M /3M Page 66
20A / 300V



.200" Pitch
EL2M Right-Offset Page 67
20A / 300V



.200" Pitch
SCM Spring-Clamp Page 80
20A / 300V

. . . FIXED BLOCKS .200" PITCH

Fixed Terminal Blocks, Spring Clamp, Edgcard Connectors

Index

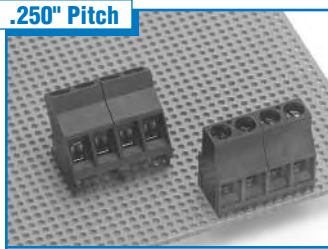

.250" Pitch
ESPM High Current Page 74
32A / 300V

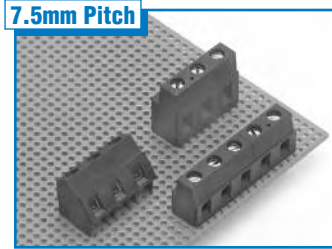

7.5mm Pitch
ESGM, ESMM, ESTM Page 75
17.5A (24A ESTM) / 300V

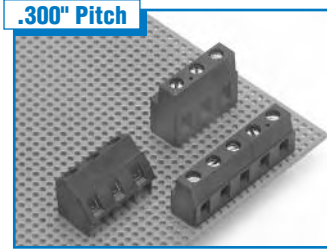

.300" Pitch
ESGM, ESMM, ESTM Page 75
17.5A (24A ESTM) / 300V

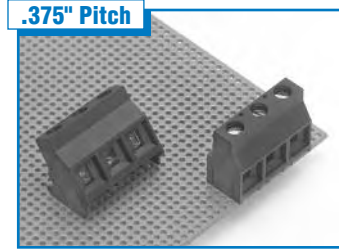

.375" Pitch
ESPM High Voltage Page 76
32A / 600V

FIXED BLOCKS .250—.375" PITCH

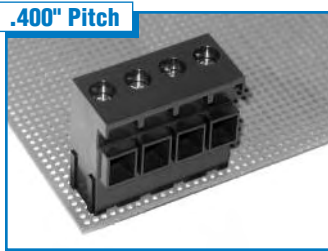

.400" Pitch
ELMP Power. Page 77

FIXED BLOCK .400" PITCH

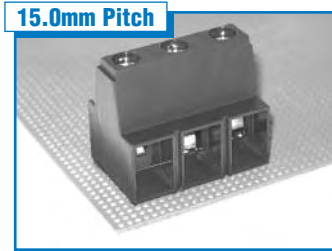

15.0mm Pitch
ELMP High Current Page 78

FIXED BLOCKS 15.0MM PITCH

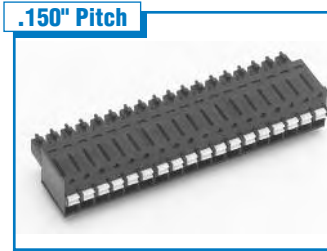

.150" Pitch
SCVF—Front-Entry Page 82
SCVF with Locking Ears . . . Page 82
12A / 300V

SPRING-CLAMP PLUG

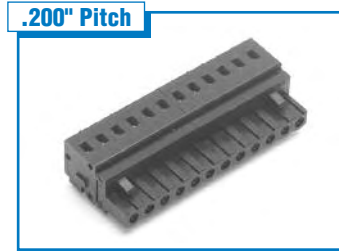

.200" Pitch
SCFF Front-Entry Page 83
12A / 300V

SPRING-CLAMP PLUG

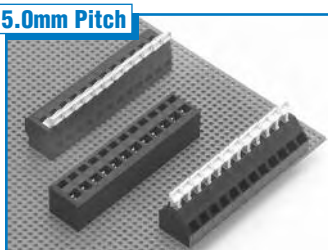

5.0mm Pitch
SCM w/ Lever
SCM w/o Lever. Page 81
20A / 300V

SPRING-CLAMP FIXED BLOCKS

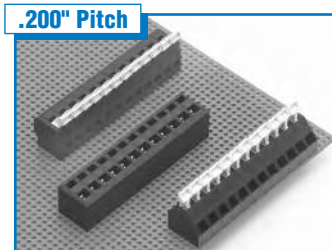

.200" Pitch
SCM w/ Lever
SCM w/o Lever. Page 80
20A / 300V



.100" Pitch
ELH—Single-Density Page 85
5A

EDGE CARD .100" PITCH

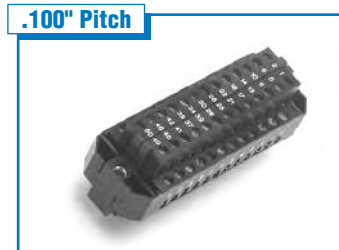

.100" Pitch
ELH Double-Density Page 85
5A

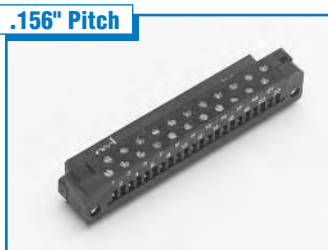

.156" Pitch
ELC Single-Sided Page 86
5A

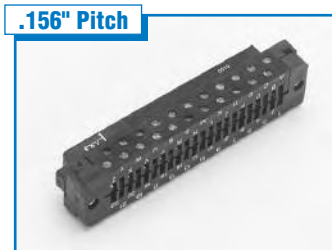

.156" Pitch
ELC Double-Sided Page 86
5A

EDGE CARD .156" PITCH



.156" Pitch
ELB Cage Clamp. Page 87
10A

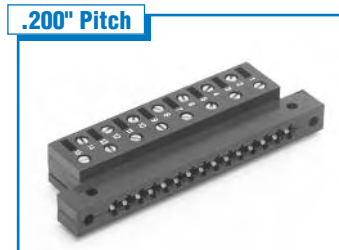

.200" Pitch
ELD Cage Clamp. Page 88
10A

EDGE CARD .200" PITCH

Custom Connectors and Modifications, Interface Modules, Cable Assembly, DIN

.375" Pitch



ELE Screw-Barrier Page 89
10A

.375" Pitch



ELI Screw-Barrier with Cover Page 90
10A

EDGECARD .375" PITCH



Standard Options Page 91



Minor Modifications Page 91

CUSTOM CONNECTORS AND MODIFICATIONS...



Major Modifications Page 92



New Systems Page 93

...CUSTOM CONNECTORS AND MODIFICATION



IDS D-Sub Page 95



IRC Ribbon Cable Page 95

INTERFACE MODULES...



IRJ Modular Jack Page 96



IDN DIN Connector Page 96



IRL Relay Module Page 96



ICN Centronics Module . . . Page 96

...INTERFACE MODULES...



Custom Modules and Systems
Pages 97-98



Cable Assemblies Page 99

...INTERFACE MODULES

CABLE ASSEMBLIES



Wire Management System
Page 100



Feed Through Page 102-104

DIN BLOCKS...

DIN Blocks



Multiple Connection Page 105



Double Level Pages 106-107



Triple Level Pages 108-109



Single Level Fused Pages 110-111

...DIN BLOCKS...



Double Level Fused Pages 112-113



Disconnect and Test Pages 114-115



Ground Pages 116-117



Thermocouple Page 117

...DIN BLOCKS...



Explosion Proof Page 118



Stud Mount Page 121



Spring-Clamp Feed-Through Page 122



Spring-Clamp Ground . . . Page 123

...DIN BLOCKS...



Spring-Clamp Multiple Connection Pages 124-125



Spring-Clamp Angled Feed-Through Pages 126-127



Spring-Clamp Angled Ground Page 128



Bus Bar Pages 130-131

...DIN BLOCKS...



DIN Insulating Accessories
Page 132



DIN Interconnecting Accessories . .
Page 133



DIN Mounting Accessories
Page 134



DIN Marking Accessories
Page 135

...DIN BLOCKS

PART NUMBER INDEX

Part	Page Number	Part	Page Number	Part	Page Number	Part	Page Number
ASA	126	ELC	86	ELFT (5.0MM)	28, 30	ESLT	68,69
ASB	122	ELD	88	ELH	55	ESMM	75
ASBG	123	ELE	89	ELI	90	ESMT	70, 71
ASBM	124	ELFA (.200")	49	ELL	53	ESPM (.250")	74
ASG	128	ELFA (5.0MM)	36	ELM (.200")	62	ESPM (.375")	76
ASMA	126	ELFB	47	ELM (5.0MM)	63	ESTM	75
ATB	102	ELFD (.200")	48	ELMM	64	ESTT	67, 72, 73
ATB	121, 130	ELFD (5.0MM)	35	ELMP	77,78	ESZ	37
ATBC	131	ELFF (.200")	39, 41	ELVA	23	FXP	42, 43
ATC	117	ELFF (5.0MM)	29, 31	ELVD	22	ICN	96
ATD	106	ELFH (.200")	44, 45	ELVF	17, 19	IDN	96
ATDF	112	ELFH (.300")	52	ELVH	16, 18	IDS	95
ATF	110	ELFH (5.0MM)	32, 33	ELVM	54	IRC	95
ATG	116	ELFH-J (5.0MM)	34	ELVP	17, 19	IRJ	96
ATM	105	ELFH-j (.200")	46	ELVT	17, 19	IRL	96
ATS	114	ELFK (.200")	39, 41	ELXH	12, 14	RJ	135
ATT	104	ELFK (.300")	51	ELXM	61	SCFF	83
ATX	118	ELFP (.200")	38, 40	ELXP	13, 15	SCM (.200")	80
EL1M	66	ELFP (.300")	50	ELXT	13, 15	SCM (5.0MM)	81
EL2M	66,67	ELFP (5.0MM)	28, 30	ESBM	58	SCVF	82
EL3M	66	ELFP-P	27	ESDM	55	SMVM	57
EL3V	59	ELFT (.200")	38, 41	ESGM	75	SMXM	57
ELB	87	ELFT (.300")	51	ESLM	65		

Approvals and Specifications

ISO QUALITY STANDARD

Amphenol Pcd is certified to ISO 9001:2000 and AS9100:2001, covering the design and manufacture of electronic connectors and interconnect systems.



Certification No. C2004-00140

UNDERWRITERS LABORATORY



File No. E83421

CANADIAN STANDARDS ASSOCIATION



File No. LR69703

TUV PRODUCT SERVICE



File No. BL 99 10 20396 003

DIN VDE 0627:1986
DIN VDE 0110-1:1989

EN 60947-1:1991
EN 60947-7-1:1992

CURRENT RATING

In accordance with UL1059, terminal block current rating is based on the maximum continuous current load that can be applied to a terminal block without a temperature rise greater than 30°C. To verify current rating, three or more poles of a terminal block are wired in series with the largest rated conductor size. Block temperature is monitored with a thermocouple mounted to the center position as current is applied. Once temperature stabilizes, maximum temperature and temperature rise over ambient are recorded. Testing is conducted in a nominal 25°C ambient.

Temperatures are considered stabilized when three successive readings at 15 minute intervals are constant. (See graph below.)

FLAMMABILITY

All board-mount and pluggable terminal blocks and headers listed through page 92 are self extinguishing and rated V0. DIN blocks and accessories indicated on pages 93 - 95 are rated V2.

OPERATING VOLTAGE

Operating voltage is dependent on conductor spacing, insulation material and workmanship. For a given voltage rating, terminal blocks are tested, in accordance with UL1059, at twice the rated voltage plus 1000V. The block must withstand this test voltage without dielectric breakdown – arcing through or over the insulating material – for one minute. Testing is performed immediately following the current rating test, while blocks are still heated, and looks for breakdown both between live block elements which are not interconnected, and between live elements and the surface to which the terminal block is mounted.



Amphenol PCD designs, manufactures and markets electronic connectors, interconnect systems and related accessories to the industrial equipment and military/avionics industries. Headquarters and primary manufacturing facilities are located in North America, with sales offices throughout the United States, and worldwide sales representation and distribution coverage.

Division of Amphenol Corporation Worldwide Presence

Amphenol Pcd is a Division of Amphenol Corporation, one of the world's largest manufacturers of interconnect products. Amphenol provides Amphenol Pcd with the backing of a multinational organization that includes well over 50 manufacturing organizations in the Americas, Europe and Asia; and sales offices, representative and electronic distributors throughout the world. Amphenol sells to and services thousands of customers in over 60 countries, and employs close to 14,000 individuals.

The experience, scope and capabilities of Amphenol Corporation greatly enhance Amphenol Pcd's ability to work with customers on a global basis; providing service, support, distribution as required, and coordinated supply and development programs to other multinationals.



Amphenol Pcd

The Company is organized as two Business Units – Industrial and Mil Aero – that serve distinct market/product segments which share the same basic electronic connector design and manufacturing technology. Both Units focus on discrete wiring interconnects, and develop and market a broad range of standard products, as well as custom connectors and systems.

Industrial Business Unit

The industrial equipment interconnects and interconnect systems set forth in this catalog are the products of the Industrial Business Unit. Amphenol Pcd is the leading North American manufacturer of both printed circuit board terminal blocks and interface modules. The primary markets we serve are Process Control, Factory Automation, Instrumentation, HVAC, Security, Datacom, UPS and Audio/Video.

Terminal blocks include a broad range of fixed-mount and pluggable European cage clamp, U.S.-style screw clamp and spring clamp style wire-to-board blocks and related headers in .100" to .375" centers, as well as a wide selection of IEC DIN

style rail-mount blocks. This range of blocks, combined with engineering responsiveness, serve as the basic elements with which a broad series of creative application solutions ranging from interface modules to new I/O block developments are created.

Interface modules are industrial interconnect devices which expand traditional terminal block I/O functions by incorporating the blocks, high density connectors and often additional components into a rail-mounted printed board assembly.

Mil Aero Business Unit

Amphenol Pcd is a leading North American supplier of avionics junction modules, relay sockets, rectangular and circular rack and panel connectors, fiber optic interconnects and aircraft and military system packages. The Mil Aero Business unit provides military, aerospace and related OEMs with an extremely broad range of high performance, high durability interconnect products and related accessories designed, manufactured and tested to rigid military and airframe customer specifications. In addition to sales offices and representatives throughout the Americas, Amphenol Pcd provides M&R inven-

Industrial Interconnections



Pluggable terminal blocks are available in a broad variety of sizes, configurations and marking variations; as well as customized variations.

tory and support through leading Avionics distributors throughout the world.

Customized Interconnect Packages

Amphenol Corporation's broad technical, product and manufacturing resources enable Amphenol Pcd to provide exceptional performance in the area of customized system development – application specific packaging which blends both Corporate and Amphenol Pcd products and know-how to provide customers with rapid, well-engineered and cost-effective custom solutions to interconnect problems. User inquiries are welcome.



New avionics junction modules incorporate electronic components in housing and circuitry.

Amphenol Pcd Philosophy

As a basic business philosophy, Amphenol Pcd is dedicated to concentrating on those advanced and challenging market segments which demand an extraordinary level of supplier support and reaction. The approach to implement this strategy is based on the following key principles:

FOCUS: Concentrate all resources on serving a limited number of tightly defined markets, and understanding the needs of those markets.

INNOVATION: Provide these markets new, creative solutions in both products and services.

RESPONSIVENESS: Identify and respond to the market and product needs more rapidly than any other supplier

Performance is the sum of these principles. It is the measure of how well we continually and consistently implement basic strategy and key principles. At Amphenol Pcd our primary goal is to provide our customers and markets with a steady record of outstanding performance.

Contact Us

Please contact Amphenol Pcd at 800 333 4723 or send an e-mail to info@amphenolpcd.com for further information, or for assistance with a standard or special interconnect application. We look forward to having the opportunity to work with you.

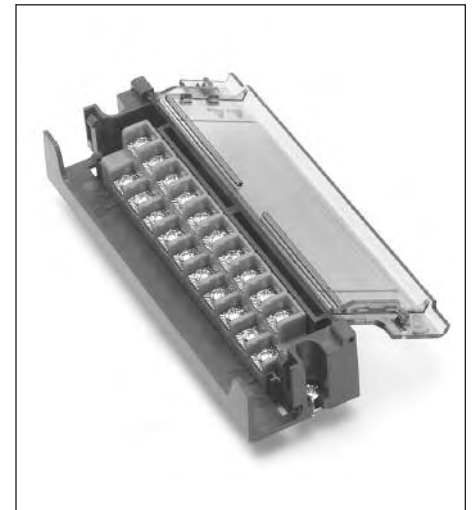

Application-specific I/O interconnects are developed in close conjunction with our customers.



Interface modules simplify connections between system I/O cards and field equipment, reduce installed cost and enhance reliability.

"FlexiPlug" is a registered trademark of Amphenol Pcd Inc.

Amphenol Pcd

3.5mm (.138")
.150" (3.81mm)

ELV/ELX Terminal Block System



SYSTEM FEATURES

The Amphenol Pcd ELV and ELX are a family of high-density, high temperature pluggable terminal blocks on .150" and 3.5mm spacing respectively, featuring a moving vise clamp wire termination system, keying capability at individual contact positions and many optional mounting and application features. Blocks are available in 2 through 20 positions (24 in some configurations), molded to size. This family features unique plug stackability for further system flexibility. The family is UL, CSA and TÜV approved.

Variations

Amphenol Pcd offers a wide selection of ELV and ELX variations and accessories. Headers are provided in straight and right angle (vertical and horizontal) designs, as well as 2-tier "stacked" designs for increased density. Plugs are available in numerous wire entry configurations, including vertical and horizontal, and the recently-introduced ELVF "front-front" design, in which both wire insertion and screw actuation are enabled from the front face of the connector, facilitating installation conditions.

Accessories and special features include a color choice of green or black, tin or gold plated contacts, locking/mounting ears and a variety of marking options.

Intermateability

The ELV and ELX are intermateable and interchangeable with industry standard .150" and 3.5mm competitive plugs and headers, but offer significant advantages in material, design, performance and flexibility.

SMT Compatibility

ELV/ELX headers are suitable for SMT reflow solder PCB manufacturing processes as well as wave solder, providing users with added application flexibility. Headers are molded of ultra-high-temperature glass-filled polyamide, which will withstand extremes of 260°C for three minutes during PCB production.

Unique Plug Stacking

Amphenol Pcd plugs can be stacked side-by-side in Amphenol Pcd headers without losing a contact position. For example, two 6-position plugs are stackable in a 12-position header, allowing multiple system configuration in one I/O area on the PC board. Competition does not offer this feature.

Current Rating

Because of superior contact element design and material selection, the ELV/ELX line has been given a UL current rating of 12A (300V)—the highest in the industry. ELV/ELX blocks will run cooler—a critical basis for reliable, long-term performance.

Fixed Wire-to-Board Connections

Related ELVM/ELXM high-density, high-temperature, wire-to-board screw terminal blocks for direct connection of wire to PCB are designed and built with the same principles and components as the pluggable connectors described above. See pages 60-61.

Amphenol Pcd

ELV/ELX Terminal Block System

OPTIONS

Optional accessories and variations greatly expand the application range and flexibility of the ELV/ELX line. Please refer to the table below for guidance in building part numbers to reflect desired variations. Contact Amphenol Pcd for additional details or application assistance.

Colors

Standard product color is black. However, all ELV/ELX products shown on pages 12-20 are also available in green—with the same delivery commitment—if compatibility with blocks previously installed on a system is required. Catalog numbers for both colors are shown in all tables. Consult factory for other colors and color matching.

Contact Plating

Standard contact plating is tin-lead. Additionally, all ELV/ELX products are also available with selectively gold plated contacts—.000030" gold over .000050" nickel—for critical applications involving low-level circuits or more severe operating conditions. To specify gold plating, the eighth digit of the ELV or ELX catalog number, as shown in the table below, is indicated as either "1" for black/gold parts or "2" for green/gold parts

Locking Ears—Plugs and Headers

Integrally molded locking ears are available with all plug and header (except 2-tier and ELVF) configurations for use in high-stress or high-vibration applications, or where unintentional disconnect must be prevented. The integrally molded ear design provides a more secure and reliable alternate to competing "snap-on" versions.

Plug ears hold a captive floating slot-head locking screw that engages a threaded insert on the header ear. The mounting screw is tightened after plug and header are mated, firmly securing the connection.



Mounting Ears—Headers only

Header locking ears can also function as mounting ears to secure vertical-mount headers to printed boards or bulkheads with provisions for threaded fasteners.

Keying

Headers are designed to accept tabs which lock into keyways in the molded plastic, and can be configured to ensure correct mating of physically similar, but electrically unique plugs. The bright yellow tabs provide a visual and physical confirmation of correct mating.

In order to key a mated pair of connectors, the header is configured with the appropriate combination of keys, and the plug is modified to suit by

trimming off the plastic tabs on the corresponding keyed contact pins. For handling convenience, keys are supplied in rings of eight. See page 25 for catalog number and ordering guidance.

Marking

Plugs are available with a variety of standard and custom position marking options. Catalog number marking designations for the most popular marking styles are indicated on the accompanying Part Numbering Guide. Please contact Amphenol Pcd to discuss requirements for special plug marking, or for header marking. Also see page 13 for details regarding stick-on marking labels.

Special Variations

Amphenol Pcd is the industry leader in providing custom PCB block configurations, tailored to meet special application or unusual system demands, and unique product identification or capability requirements. Please contact us to discuss individual needs.

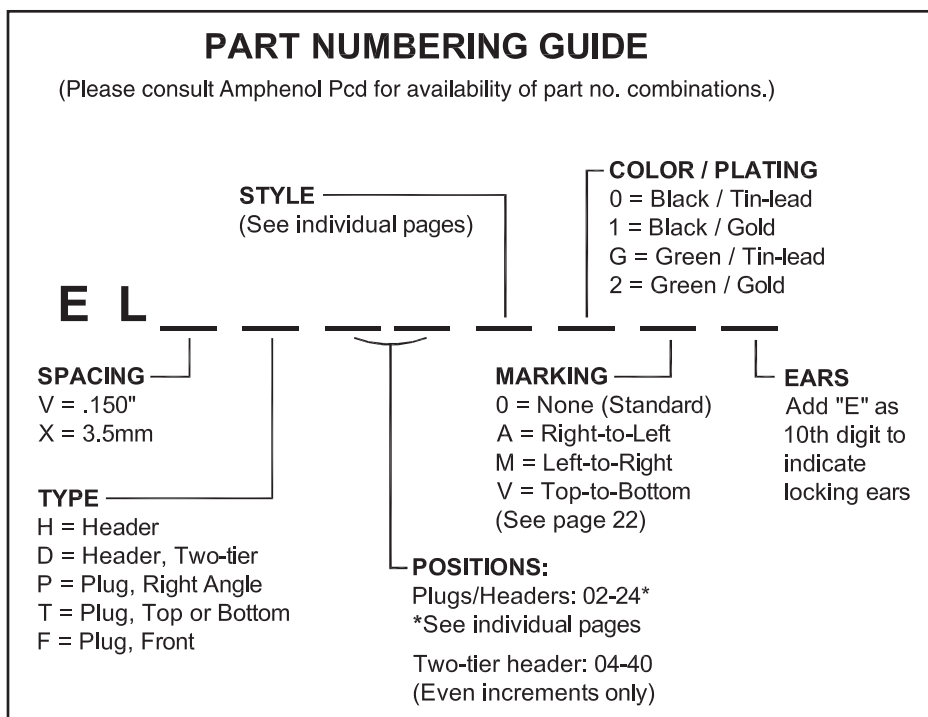

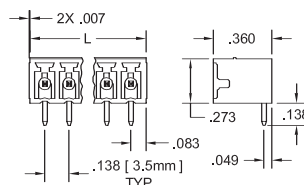
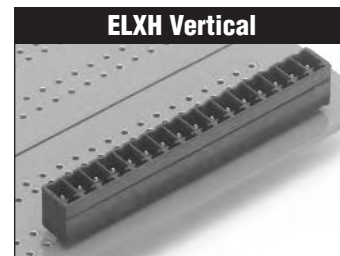

HEADERS

ELXH headers are molded of ultra-high-temperature polyamide, which will withstand temperatures to 260°C during the PCB production process, and are compatible with SMT reflow soldering as well as wave soldering processes. The headers are available in vertical and horizontal versions. A shrouded design and keying capability prevent mismatching. Headers mate with PCD and competitive 3.5mm pluggable terminal blocks. Multiple PCD ELX plugs can be stacked end-to-end in a header without loss of a contact position.

ACCESSORIES

Polarizing keys and marking labels. See page 13.

PLUGS

All ELX pluggable terminal blocks incorporate moving vise clamp wire termination and mate with PCD ELX headers.

ELXP blocks feature wire entry parallel to contact.

ELXT blocks offer wire entry perpendicular to contact—top or bottom entry is available.

VARIATIONS

See pages 12 and 13 for additional information on plug and header variations and Part Numbering Guide for ordering specifics.

Pos	Catalog #		L (mm)	Pos	Catalog #		L (mm)
	Black	Green			Black	Green	
2	ELXH02100	ELXH021G0	7.72	2	ELXH02500	ELXH025G0	7.72
3	ELXH03100	ELXH031G0	11.22	3	ELXH03500	ELXH035G0	11.22
4	ELXH04100	ELXH041G0	14.72	4	ELXH04500	ELXH045G0	14.72
5	ELXH05100	ELXH051G0	18.22	5	ELXH05500	ELXH055G0	18.22
6	ELXH06100	ELXH061G0	21.72	6	ELXH06500	ELXH065G0	21.72
7	ELXH07100	ELXH071G0	25.22	7	ELXH07500	ELXH075G0	25.22
8	ELXH08100	ELXH081G0	28.72	8	ELXH08500	ELXH085G0	28.72
9	ELXH09100	ELXH091G0	32.22	9	ELXH09500	ELXH095G0	32.22
10	ELXH10100	ELXH101G0	35.72	10	ELXH10500	ELXH105G0	35.72
11	ELXH11100	ELXH111G0	39.22	11	ELXH11500	ELXH115G0	39.22
12	ELXH12100	ELXH121G0	42.72	12	ELXH12500	ELXH125G0	42.72
13	ELXH13100	ELXH131G0	46.22	13	ELXH13500	ELXH135G0	46.22
14	ELXH14100	ELXH141G0	49.72	14	ELXH14500	ELXH145G0	49.72
15	ELXH15100	ELXH151G0	53.22	15	ELXH15500	ELXH155G0	53.22
16	ELXH16100	ELXH161G0	56.72	16	ELXH16500	ELXH165G0	56.72
17	ELXH17100	ELXH171G0	60.22	17	ELXH17500	ELXH175G0	60.22
18	ELXH18100	ELXH181G0	63.72	18	ELXH18500	ELXH185G0	63.72
19	ELXH19100	ELXH191G0	67.22	19	ELXH19500	ELXH195G0	67.22
20	ELXH20100	ELXH201G0	70.72	20	ELXH20500	ELXH205G0	70.72
21	ELXH21100	ELXH211G0	74.22	21	ELXH21500	ELXH215G0	74.22
22	ELXH22100	ELXH221G0	77.72	22	ELXH22500	ELXH225G0	77.72
23	ELXH23100	ELXH231G0	81.22	23	ELXH23500	ELXH235G0	81.22
24	ELXH24100	ELXH241G0	84.72	24	ELXH24500	ELXH245G0	84.72

See page 13 for gold plating and marking options

APPROVALS:



Consult factory for specific product recognitions

SPECIFICATIONS:

Current Rating: 12A
Operating Voltage: 300V
Insulation Resistance: >10³ Megohms
Dielectric Withstanding: <1600V

MATERIALS:

Housing: Polyamide, UL 94V-0, black or green
Contact: Copper alloy, optional finish

HEADER INSTALLATION:

Hole Diameter: .047" min.

ELXP/ELXT MINI-PLUGS Right Angle/Straight

3.5mm (.138")



Pos	Catalog # Black	Catalog # Green	L (mm)	Pos	Catalog # Black	Catalog # Green	L (mm)	Pos	Catalog # Black	Catalog # Green	L (mm)
2	ELXP02100	ELXP021G0	7.0	2	ELXT02500	ELXT025G0	7.0	2	ELXT02600	ELXT026G0	7.0
3	ELXP03100	ELXP031G0	10.5	3	ELXT03500	ELXT035G0	10.5	3	ELXT03600	ELXT036G0	10.5
4	ELXP04100	ELXP041G0	14.0	4	ELXT04500	ELXT045G0	14.0	4	ELXT04600	ELXT046G0	14.0
5	ELXP05100	ELXP051G0	17.5	5	ELXT05500	ELXT055G0	17.5	5	ELXT05600	ELXT056G0	17.5
6	ELXP06100	ELXP061G0	21.0	6	ELXT06500	ELXT065G0	21.0	6	ELXT06600	ELXT066G0	21.0
7	ELXP07100	ELXP071G0	24.5	7	ELXT07500	ELXT075G0	24.5	7	ELXT07600	ELXT076G0	24.5
8	ELXP08100	ELXP081G0	28.0	8	ELXT08500	ELXT085G0	28.0	8	ELXT08600	ELXT086G0	28.0
9	ELXP09100	ELXP091G0	31.5	9	ELXT09500	ELXT095G0	31.5	9	ELXT09600	ELXT096G0	31.5
10	ELXP10100	ELXP101G0	35.0	10	ELXT10500	ELXT105G0	35.0	10	ELXT10600	ELXT106G0	35.0
11	ELXP11100	ELXP111G0	38.5	11	ELXT11500	ELXT115G0	38.5	11	ELXT11600	ELXT116G0	38.5
12	ELXP12100	ELXP121G0	42.0	12	ELXT12500	ELXT125G0	42.0	12	ELXT12600	ELXT126G0	42.0
13	ELXP13100	ELXP131G0	45.5	13	ELXT13500	ELXT135G0	45.5	13	ELXT13600	ELXT136G0	45.5
14	ELXP14100	ELXP141G0	49.0	14	ELXT14500	ELXT145G0	49.0	14	ELXT14600	ELXT146G0	49.0
15	ELXP15100	ELXP151G0	52.5	15	ELXT15500	ELXT155G0	52.5	15	ELXT15600	ELXT156G0	52.5
16	ELXP16100	ELXP161G0	56.0	16	ELXT16500	ELXT165G0	56.0	16	ELXT16600	ELXT166G0	56.0
17	ELXP17100	ELXP171G0	59.5	17	ELXT17500	ELXT175G0	59.5	17	ELXT17600	ELXT176G0	59.5
18	ELXP18100	ELXP181G0	63.0	18	ELXT18500	ELXT185G0	63.0	18	ELXT18600	ELXT186G0	63.0
19	ELXP19100	ELXP191G0	66.5	19	ELXT19500	ELXT195G0	66.5	19	ELXT19600	ELXT196G0	66.0
20	ELXP20100	ELXP201G0	70.0	20	ELXT20500	ELXT205G0	70.0	20	ELXT20600	ELXT206G0	70.0
21	ELXP21100	ELXP211G0	73.5								
22	ELXP22100	ELXP221G0	77.0								
23	ELXP23100	ELXP231G0	80.5								
24	ELXP24100	ELXP241G0	84.0								

See page 13 for gold plating and marking options

SPECIFICATIONS:

Current Rating: 12A
Operating Voltage: 300V
Insulation Resistance: >10³ Megohms
Dielectric Withstanding: <1600V
Wire Pullout Force:
 Per UL 486E, Section 14

MATERIALS:

Housing: Polyamide, UL 94V-0, black or green
Contact: Copper alloy, optional finish
Clamp Screw: Copper alloy, nickel finish
Wire Clamp: Copper alloy, nickel finish

WIRE INSTALLATION:

Wire Range: #16-28 AWG
Wire Strip Length: 0.25"
Recommended Tightening Torque:
 2.2 lb-in. (0.25N-m)

APPROVALS:

Consult factory for specific product recognitions

POLARIZING KEYS FOR ELV AND ELX

ELV and ELX family headers are designed to accept tabs which lock into keyways in the body moldings, and can be configured to ensure correct mating of physically similar but electrically unique plugs and headers—and to prevent incorrect mating of the wrong connectors.

Keying is accomplished without loss of a contact position.

In order to key a mated plug and header pair, the header is configured with the appropriate keys, and the plug is modified by trimming off the protruding tabs on the corresponding contact positions. The bright yellow tabs provide a visual and physical confirmation of correct mating.

For handling convenience, keys are supplied in rings of eight. Order Part No. 300800000.

MARKING LABELS

Stick-on marking labels, printed on vinyl cloth, are available in two versions:

ELVLABEL1: Nos. 1-10
 ELVLABEL2: Nos. 11-20

Labels are supplied in sheets containing 25 peel-off strips.

Amphenol Pcd

ELXH MINI-HEADERS w/ LOCKING EARS Vertical and Horizontal



ELX CONNECTORS WITH LOCKING EARS

These two pages present the locking ear versions of the 3.5mm spacing (ELX) plugs and headers depicted on pages 12 and 13.

The integrally molded locking ears are available with ELXP and ELXT plugs, and ELXH series headers. Plug ears hold a captive floating, slot-head locking screw that engages a threaded insert on the header ear. The mounting screw is tightened after plug and header are firmly mated, securing the connection. All plugs and headers indicated on these pages are intermateable and interchangeable with industry standard 3.5mm plugs and headers.

VARIATIONS

See pages 12 and 13 for additional information on plug and header variations and for ordering specifics.

APPROVALS:



Consult factory for specific product recognitions

HEADERS

ELX headers are molded of ultra-high-temperature polyamide, which will withstand temperatures to 260°C during the PCB production process, and are compatible with SMT reflow soldering. The headers are available in vertical and horizontal versions. A shrouded design and keying capability prevent mismatching.

PLUGS

All ELX pluggable terminal blocks incorporate moving vise clamp wire termination.

ELXP blocks feature wire entry parallel to contact.

ELXT blocks offer wire entry perpendicular to contact—top or bottom entry is available.

ACCESSORIES

Polarizing keys and marking labels. See page 13.

Pos	Catalog # Black	Catalog # Green	L (mm)	Pos	Catalog # Black	Catalog # Green	L (mm)
2	ELXH02100E	ELXH021G0E	17.32	2	ELXH02500E	ELXH025G0E	17.32
3	ELXH03100E	ELXH031G0E	20.82	3	ELXH03500E	ELXH035G0E	20.82
4	ELXH04100E	ELXH041G0E	24.32	4	ELXH04500E	ELXH045G0E	24.32
5	ELXH05100E	ELXH051G0E	27.82	5	ELXH05500E	ELXH055G0E	27.82
6	ELXH06100E	ELXH061G0E	31.32	6	ELXH06500E	ELXH065G0E	31.32
7	ELXH07100E	ELXH071G0E	34.82	7	ELXH07500E	ELXH075G0E	34.82
8	ELXH08100E	ELXH081G0E	38.32	8	ELXH08500E	ELXH085G0E	38.32
9	ELXH09100E	ELXH091G0E	41.82	9	ELXH09500E	ELXH095G0E	41.82
10	ELXH10100E	ELXH101G0E	45.32	10	ELXH10500E	ELXH105G0E	45.32
11	ELXH11100E	ELXH111G0E	48.82	11	ELXH11500E	ELXH115G0E	48.82
12	ELXH12100E	ELXH121G0E	52.32	12	ELXH12500E	ELXH125G0E	52.32
13	ELXH13100E	ELXH131G0E	55.82	13	ELXH13500E	ELXH135G0E	55.82
14	ELXH14100E	ELXH141G0E	59.32	14	ELXH14500E	ELXH145G0E	59.32
15	ELXH15100E	ELXH151G0E	62.82	15	ELXH15500E	ELXH155G0E	62.82
16	ELXH16100E	ELXH161G0E	66.32	16	ELXH16500E	ELXH165G0E	66.32
17	ELXH17100E	ELXH171G0E	69.82	17	ELXH17500E	ELXH175G0E	69.82
18	ELXH18100E	ELXH181G0E	73.32	18	ELXH18500E	ELXH185G0E	73.32
19	ELXH19100E	ELXH191G0E	76.82	19	ELXH19500E	ELXH195G0E	76.82
20	ELXH20100E	ELXH201G0E	80.32	20	ELXH20500E	ELXH205G0E	80.32
21	ELXH21100E	ELXH211G0E	83.82	21	ELXH21500E	ELXH215G0E	83.82
22	ELXH22100E	ELXH221G0E	87.32	22	ELXH22500E	ELXH225G0E	87.32
23	ELXH23100E	ELXH231G0E	90.82	23	ELXH23500E	ELXH235G0E	90.82
24	ELXH24100E	ELXH241G0E	94.32	24	ELXH24500E	ELXH245G0E	94.32

See page 13 for gold plating and marking options

SPECIFICATIONS:

Current Rating: 12A
Operating Voltage: 300V
Insulation Resistance: >10³ Megohms
Dielectric Withstanding: <1600V

MATERIALS:

Housing: Polyamide, UL 94V-0, black or green
Contact: Copper alloy, optional finish
Ear Insert, M2.5: Brass, nickel finish

HEADER INSTALLATION:

Hole Diameter: .047" min.

ELXP/ELXT MINI-PLUGS w/ LOCKING EARS Right Angle/Straight

3.5mm (.138")

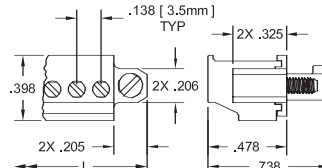
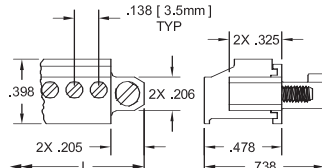
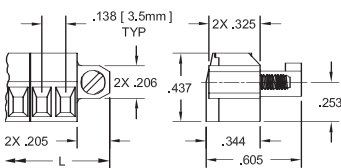
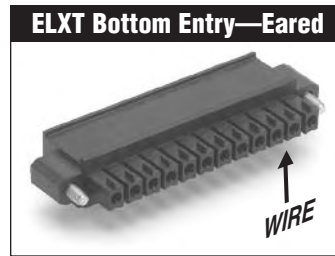
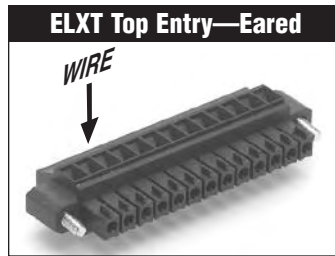
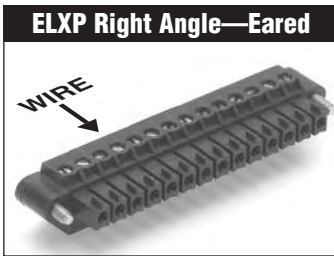

Pos	Catalog # Black	Catalog # Green	L (mm)	Pos	Catalog # Black	Catalog # Green	L (mm)	Pos	Catalog # Black	Catalog # Green	L (mm)
2	ELXP02100E	ELXP021G0E	17.42	2	ELXT02500E	ELXT025G0E	17.42	2	ELXT02600E	ELXT026G0E	17.42
3	ELXP03100E	ELXP031G0E	20.92	3	ELXT03500E	ELXT035G0E	20.92	3	ELXT03600E	ELXT036G0E	20.92
4	ELXP04100E	ELXP041G0E	24.42	4	ELXT04500E	ELXT045G0E	24.42	4	ELXT04600E	ELXT046G0E	24.42
5	ELXP05100E	ELXP051G0E	27.92	5	ELXT05500E	ELXT055G0E	27.92	5	ELXT05600E	ELXT056G0E	27.92
6	ELXP06100E	ELXP061G0E	31.42	6	ELXT06500E	ELXT065G0E	31.42	6	ELXT06600E	ELXT066G0E	31.42
7	ELXP07100E	ELXP071G0E	34.92	7	ELXT07500E	ELXT075G0E	34.92	7	ELXT07600E	ELXT076G0E	34.92
8	ELXP08100E	ELXP081G0E	38.42	8	ELXT08500E	ELXT085G0E	38.42	8	ELXT08600E	ELXT086G0E	38.42
9	ELXP09100E	ELXP091G0E	41.92	9	ELXT09500E	ELXT095G0E	41.92	9	ELXT09600E	ELXT096G0E	41.92
10	ELXP10100E	ELXP101G0E	45.42	10	ELXT10500E	ELXT105G0E	45.42	10	ELXT10600E	ELXT106G0E	45.42
11	ELXP11100E	ELXP111G0E	48.92	11	ELXT11500E	ELXT115G0E	48.92	11	ELXT11600E	ELXT116G0E	48.92
12	ELXP12100E	ELXP121G0E	52.42	12	ELXT12500E	ELXT125G0E	52.42	12	ELXT12600E	ELXT126G0E	52.42
13	ELXP13100E	ELXP131G0E	55.92	13	ELXT13500E	ELXT135G0E	55.92	13	ELXT13600E	ELXT136G0E	55.92
14	ELXP14100E	ELXP141G0E	59.42	14	ELXT14500E	ELXT145G0E	59.42	14	ELXT14600E	ELXT146G0E	59.42
15	ELXP15100E	ELXP151G0E	62.92	15	ELXT15500E	ELXT155G0E	62.92	15	ELXT15600E	ELXT156G0E	62.92
16	ELXP16100E	ELXP161G0E	66.42	16	ELXT16500E	ELXT165G0E	66.42	16	ELXT16600E	ELXT166G0E	66.42
17	ELXP17100E	ELXP171G0E	69.92	17	ELXT17500E	ELXT175G0E	69.92	17	ELXT17600E	ELXT176G0E	69.92
18	ELXP18100E	ELXP181G0E	73.42	18	ELXT18500E	ELXT185G0E	73.42	18	ELXT18600E	ELXT186G0E	73.42
19	ELXP19100E	ELXP191G0E	76.92	19	ELXT19500E	ELXT195G0E	76.92	19	ELXT19600E	ELXT196G0E	76.92
20	ELXP20100E	ELXP201G0E	80.42	20	ELXT20500E	ELXT205G0E	80.42	20	ELXT20600E	ELXT206G0E	80.42
21	ELXP21100E	ELXP211G0E	83.92								
22	ELXP22100E	ELXP221G0E	87.42								
23	ELXP23100E	ELXP231G0E	90.92								
24	ELXP24100E	ELXP241G0E	94.42								

See page 13 for gold plating and marking options

SPECIFICATIONS:

Current Rating: 12A
Operating Voltage: 300V
Dielectric Withstanding: <1600V
Insulation Resistance: >10³ Megohms
Wire Pullout Force:
 Per UL 486E, Section 14

MATERIALS:

Housing: Polyamide, UL 94V-0, black or green
Contact: Copper alloy, optional finish
Clamp Screw: Copper alloy, nickel finish
Wire Clamp: Copper alloy, nickel finish
Ear Screw, M2.5: Steel, nickel finish

WIRE INSTALLATION:

Wire Range: #16-28 AWG
Wire Strip Length: 0.25"
Recommended Tightening Torque:
 2.2 lb-in. (0.25N-m)

APPROVALS:



Amphenol Pcd

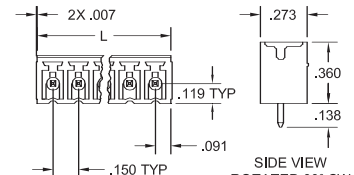
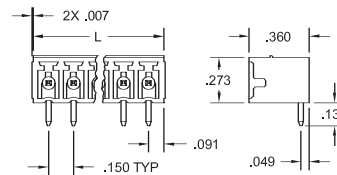
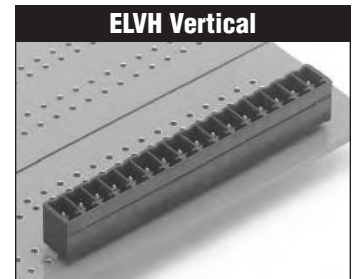
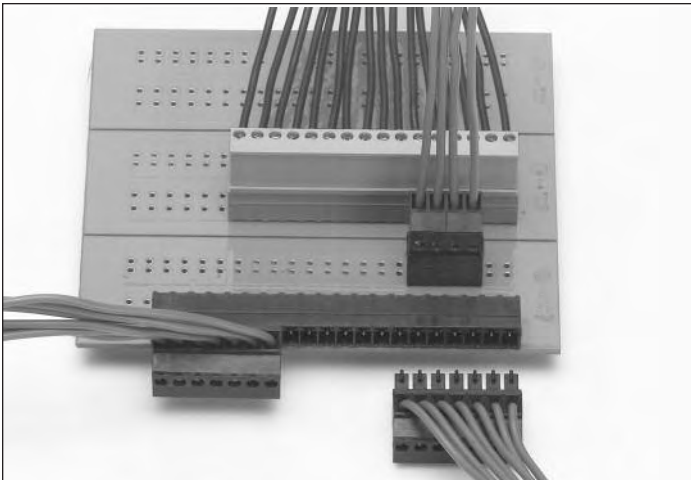

HEADERS

ELVH headers are molded of an ultra-high-temperature polyamide, which will withstand temperatures to 260°C during the PCB production process, and are compatible with SMT reflow soldering as well as wave soldering processes. The headers are available in vertical and horizontal versions. A shrouded design and keying capability prevent mismatching. Headers mate with PCD and industry standard competitive .150" pluggable terminal blocks. Multiple PCD ELV plugs can be stacked end-to-end in a header without loss of a contact position.

For greater-density applications 2-tier headers are available in the ELV family. See the ELVA header line featured on page 23.

ACCESSORIES

Polarizing keys and marking labels. See page 13.

PLUGS

All ELV pluggable terminal blocks incorporate moving vise clamp wire termination and mate with PCD ELVH headers.

ELVP blocks feature wire entry parallel to contact.

ELVT blocks offer wire entry perpendicular to contact—top or bottom entry is available.

ELVF "front-front" blocks allow both wire insertion and screw actuation from the front of the plug, facilitating access and installation.

SCVF spring clamp plugs (page 74) offer an alternate wire termination approach.

VARIATIONS

See pages 12 and 13 for additional information on plug and header variations and Part Numbering Guide for ordering specifics.

APPROVALS:



Consult factory for specific product recognitions

Pos	Catalog # Black	Catalog # Green	L (In.)	Pos	Catalog # Black	Catalog # Green	L (In.)
2	ELVH02100	ELVH021G0	.332	2	ELVH02500	ELVH025G0	.332
3	ELVH03100	ELVH031G0	.482	3	ELVH03500	ELVH035G0	.482
4	ELVH04100	ELVH041G0	.632	4	ELVH04500	ELVH045G0	.632
5	ELVH05100	ELVH051G0	.782	5	ELVH05500	ELVH055G0	.782
6	ELVH06100	ELVH061G0	.932	6	ELVH06500	ELVH065G0	.932
7	ELVH07100	ELVH071G0	1.082	7	ELVH07500	ELVH075G0	1.082
8	ELVH08100	ELVH081G0	1.232	8	ELVH08500	ELVH085G0	1.232
9	ELVH09100	ELVH091G0	1.382	9	ELVH09500	ELVH095G0	1.382
10	ELVH10100	ELVH101G0	1.532	10	ELVH10500	ELVH105G0	1.532
11	ELVH11100	ELVH111G0	1.682	11	ELVH11500	ELVH115G0	1.682
12	ELVH12100	ELVH121G0	1.832	12	ELVH12500	ELVH125G0	1.832
13	ELVH13100	ELVH131G0	1.982	13	ELVH13500	ELVH135G0	1.982
14	ELVH14100	ELVH141G0	2.132	14	ELVH14500	ELVH145G0	2.132
15	ELVH15100	ELVH151G0	2.282	15	ELVH15500	ELVH155G0	2.282
16	ELVH16100	ELVH161G0	2.432	16	ELVH16500	ELVH165G0	2.432
17	ELVH17100	ELVH171G0	2.582	17	ELVH17500	ELVH175G0	2.582
18	ELVH18100	ELVH181G0	2.732	18	ELVH18500	ELVH185G0	2.732
19	ELVH19100	ELVH191G0	2.882	19	ELVH19500	ELVH195G0	2.882
20	ELVH20100	ELVH201G0	3.032	20	ELVH20500	ELVH205G0	3.032
21	ELVH21100	ELVH211G0	3.182	21	ELVH21500	ELVH215G0	3.182
22	ELVH22100	ELVH221G0	3.332	22	ELVH22500	ELVH225G0	3.332
23	ELVH23100	ELVH231G0	3.482	23	ELVH23500	ELVH235G0	3.482
24	ELVH24100	ELVH241G0	3.632	24	ELVH24500	ELVH245G0	3.632

See page 13 for gold plating and marking options

SPECIFICATIONS:

Current Rating: 12A
Operating Voltage: 300V
Insulation Resistance: >10³ Megohms
Dielectric Withstanding: <1600V

MATERIALS:

Housing: Polyamide, UL 94V-0, black or green
Contact: Copper alloy, optional finish

HEADER INSTALLATION:

Hole Diameter: .047" min.

ELVP/ELVT/ELVF MINI-PLUGS Right Angle/Straight/Front

.150" (3.81mm)

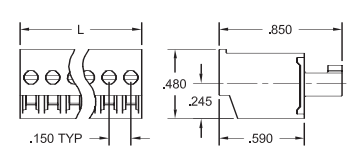
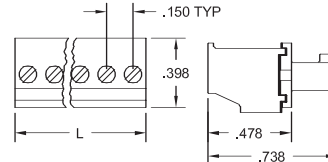
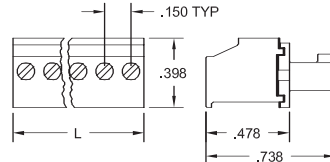
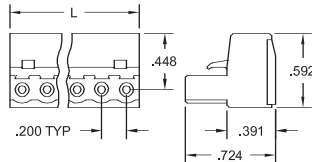
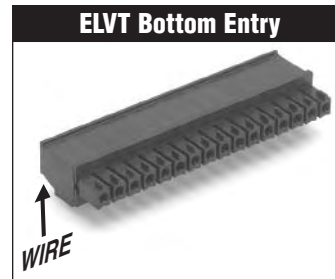
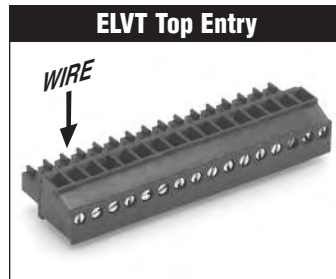
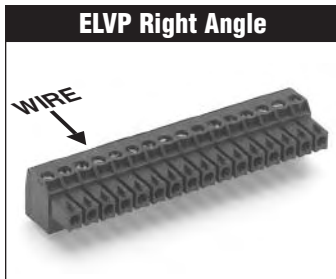

Pos	Catalog # Black	Catalog # Green	L (In.)	Pos	Catalog # Black	Catalog # Green	L (In.)	Pos	Catalog # Black	Catalog # Green	L (In.)	Pos	Catalog # Black	Catalog # Green	L (In.)
2	ELVP02100	ELVP021G0	.300	2	ELVT02500	ELVT025G0	.300	2	ELVT02600	ELVT026G0	.300	2	ELVF02400	ELVF024G0	.300
3	ELVP03100	ELVP031G0	.450	3	ELVT03500	ELVT035G0	.450	3	ELVT03600	ELVT036G0	.450	3	ELVF03400	ELVF034G0	.450
4	ELVP04100	ELVP041G0	.600	4	ELVT04500	ELVT045G0	.600	4	ELVT04600	ELVT046G0	.600	4	ELVF04400	ELVF044G0	.600
5	ELVP05100	ELVP051G0	.750	5	ELVT05500	ELVT055G0	.750	5	ELVT05600	ELVT056G0	.750	5	ELVF05400	ELVF054G0	.750
6	ELVP06100	ELVP061G0	.900	6	ELVT06500	ELVT065G0	.900	6	ELVT06600	ELVT066G0	.900	6	ELVF06400	ELVF064G0	.900
7	ELVP07100	ELVP071G0	1.050	7	ELVT07500	ELVT075G0	1.050	7	ELVT07600	ELVT076G0	1.050	7	ELVF07400	ELVF074G0	1.050
8	ELVP08100	ELVP081G0	1.200	8	ELVT08500	ELVT085G0	1.200	8	ELVT08600	ELVT086G0	1.200	8	ELVF08400	ELVF084G0	1.200
9	ELVP09100	ELVP091G0	1.350	9	ELVT09500	ELVT095G0	1.350	9	ELVT09600	ELVT096G0	1.350	9	ELVF09400	ELVF094G0	1.350
10	ELVP10100	ELVP101G0	1.500	10	ELVT10500	ELVT105G0	1.500	10	ELVT10600	ELVT106G0	1.500	10	ELVF10400	ELVF104G0	1.500
11	ELVP11100	ELVP111G0	1.650	11	ELVT11500	ELVT115G0	1.650	11	ELVT11600	ELVT116G0	1.650	11	ELVF11400	ELVF114G0	1.650
12	ELVP12100	ELVP121G0	1.800	12	ELVT12500	ELVT125G0	1.800	12	ELVT12600	ELVT126G0	1.800	12	ELVF12400	ELVF124G0	1.800
13	ELVP13100	ELVP131G0	1.950	13	ELVT13500	ELVT135G0	1.950	13	ELVT13600	ELVT136G0	1.950	13	ELVF13400	ELVF134G0	1.950
14	ELVP14100	ELVP141G0	2.100	14	ELVT14500	ELVT145G0	2.100	14	ELVT14600	ELVT146G0	2.100	14	ELVF14400	ELVF144G0	2.100
15	ELVP15100	ELVP151G0	2.250	15	ELVT15500	ELVT155G0	2.250	15	ELVT15600	ELVT156G0	2.250	15	ELVF15400	ELVF154G0	2.250
16	ELVP16100	ELVP161G0	2.400	16	ELVT16500	ELVT165G0	2.400	16	ELVT16600	ELVT166G0	2.400	16	ELVF16400	ELVF164G0	2.400
17	ELVP17100	ELVP171G0	2.550	17	ELVT17500	ELVT175G0	2.550	17	ELVT17600	ELVT176G0	2.550	17	ELVF17400	ELVF174G0	2.550
18	ELVP18100	ELVP181G0	2.700	18	ELVT18500	ELVT185G0	2.700	18	ELVT18600	ELVT186G0	2.700	18	ELVF18400	ELVF184G0	2.700
19	ELVP19100	ELVP191G0	2.850	19	ELVT19500	ELVT195G0	2.850	19	ELVT19600	ELVT196G0	2.850	19	ELVF19400	ELVF194G0	2.850
20	ELVP20100	ELVP201G0	3.000	20	ELVT20500	ELVT205G0	3.000	20	ELVT20600	ELVT206G0	3.000	20	ELVF20400	ELVF204G0	3.000

See page 13 for gold plating and marking options

SPECIFICATIONS:

Current Rating: 12A
Operating Voltage: 300V
Insulation Resistance: >10³ Megohms
Dielectric Withstanding: <1600V
Wire Pullout Force:
 Per UL 486E, Section 14

MATERIALS:

Housing: Polyamide, UL 94V-0, black or green
Contact: Copper alloy, optional finish
Clamp Screw: Copper alloy, nickel finish
Wire Clamp: Copper alloy, nickel finish

WIRE INSTALLATION:

Wire Range: #16-28 AWG
Wire Strip Length: 0.25" (.375" ELVF)
Recommended Tightening Torque: 2.2 lb-in. (0.25N-m)

APPROVALS:



Consult factory for specific product recognitions

Amphenol Pcd

.150" (3.81mm)

ELVH MINI-HEADERS with LOCKING EARS Vertical and Horizontal

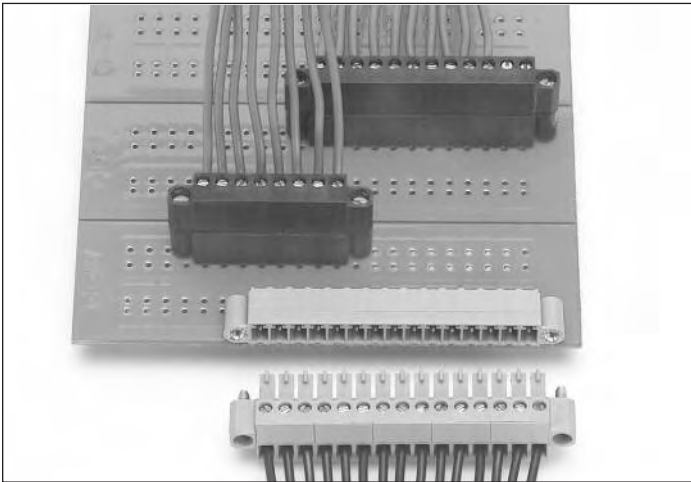

ELV CONNECTORS WITH LOCKING EARS

These two pages present the locking ear versions of the .150" spacing (ELV) plugs and headers depicted on pages 16 and 17.

The integrally molded locking ears are available with ELVP and ELVT plugs, and ELVH series headers. Plug ears hold a captive floating, slot-head locking screw that engages a threaded insert on the header ear. The mounting screw is tightened after plug and header are firmly mated, securing the connection. All plugs and headers indicated on these pages are intermateable and interchangeable with industry standard .150" plugs and headers.

VARIATIONS

See pages 12 and 13 for additional information on plug and header variations and for ordering specifics.

APPROVALS:



Consult factory for specific product recognitions

HEADERS

ELVH headers are molded of ultra-high-temperature polyamide, which will withstand temperatures to 260°C during the PCB production process, and are compatible with SMT reflow soldering. The headers are available in vertical and horizontal versions. A shrouded design and keying capability prevent mismatching.

PLUGS

All ELV pluggable terminal blocks incorporate moving vise clamp wire termination.

ELVP blocks feature wire entry parallel to the contact.

ELVT blocks offer wire entry perpendicular to the contact—top or bottom entry is available.

ACCESSORIES

Polarizing keys and marking labels. See page 13.

Pos	Catalog # Black	Catalog # Green	L (In.)	Pos	Catalog # Black	Catalog # Green	L (In.)
2	ELVH02100E	ELVH021G0E	.710	2	ELVH02500E	ELVH025G0E	.710
3	ELVH03100E	ELVH031G0E	.860	3	ELVH03500E	ELVH035G0E	.860
4	ELVH04100E	ELVH041G0E	1.010	4	ELVH04500E	ELVH045G0E	1.010
5	ELVH05100E	ELVH051G0E	1.160	5	ELVH05500E	ELVH055G0E	1.160
6	ELVH06100E	ELVH061G0E	1.310	6	ELVH06500E	ELVH065G0E	1.310
7	ELVH07100E	ELVH071G0E	1.460	7	ELVH07500E	ELVH075G0E	1.460
8	ELVH08100E	ELVH081G0E	1.610	8	ELVH08500E	ELVH085G0E	1.610
9	ELVH09100E	ELVH091G0E	1.760	9	ELVH09500E	ELVH095G0E	1.760
10	ELVH10100E	ELVH101G0E	1.910	10	ELVH10500E	ELVH105G0E	1.910
11	ELVH11100E	ELVH111G0E	2.060	11	ELVH11500E	ELVH115G0E	2.060
12	ELVH12100E	ELVH121G0E	2.210	12	ELVH12500E	ELVH125G0E	2.210
13	ELVH13100E	ELVH131G0E	2.360	13	ELVH13500E	ELVH135G0E	2.360
14	ELVH14100E	ELVH141G0E	2.510	14	ELVH14500E	ELVH145G0E	2.510
15	ELVH15100E	ELVH151G0E	2.660	15	ELVH15500E	ELVH155G0E	2.660
16	ELVH16100E	ELVH161G0E	2.810	16	ELVH16500E	ELVH165G0E	2.810
17	ELVH17100E	ELVH171G0E	2.960	17	ELVH17500E	ELVH175G0E	2.960
18	ELVH18100E	ELVH181G0E	3.110	18	ELVH18500E	ELVH185G0E	3.110
19	ELVH19100E	ELVH191G0E	3.260	19	ELVH19500E	ELVH195G0E	3.260
20	ELVH20100E	ELVH201G0E	3.410	20	ELVH20500E	ELVH205G0E	3.410

See page 13 for gold plating and marking options

SPECIFICATIONS:

Current Rating: 12A
Operating Voltage: 300V
Insulation Resistance: >10³ Megohms
Dielectric Withstanding: <1600V

MATERIALS:

Housing: Polyamide, UL 94V-0, black or green
Contact: Copper alloy, optional finish
Ear Insert, M2.5: Brass, nickel finish

HEADER INSTALLATION:

Hole Diameter: .047" min.

Amphenol Pcd

ELVP/ELVT/ELVF MINI-PLUGS with LOCKING EARS Right Angle/Straight/Front

.150" (3.81mm)

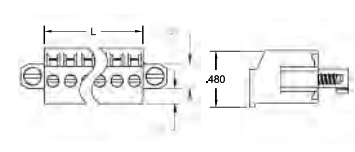
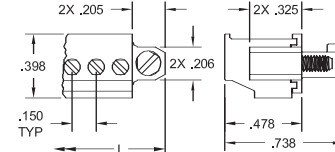
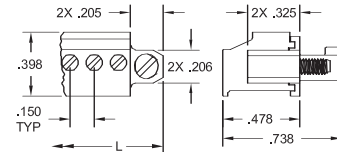
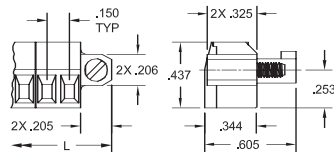
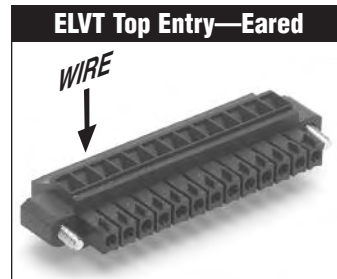
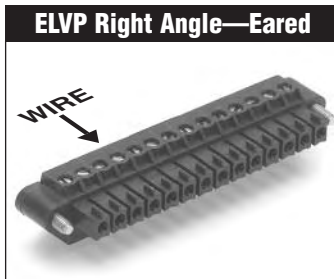

Pos	Catalog # Black	Catalog # Green	L (In.)	Pos	Catalog # Black	Catalog # Green	L (In.)	Pos	Catalog # Black	Catalog # Green	L (In.)	Pos	Catalog # Black	Catalog # Green	L (In.)
2	ELVP02100E	ELVP021G0E	.710	2	ELVT02500E	ELVT025G0E	.710	2	ELVT02600E	ELVT026G0E	.710	2	ELVF02400E	ELVF024G0E	.710
3	ELVP03100E	ELVP031G0E	.860	3	ELVT03500E	ELVT035G0E	.860	3	ELVT03600E	ELVT036G0E	.860	3	ELVF03400E	ELVF034G0E	.860
4	ELVP04100E	ELVP041G0E	1.010	4	ELVT04500E	ELVT045G0E	1.010	4	ELVT04600E	ELVT046G0E	1.010	4	ELVF04400E	ELVF044G0E	1.010
5	ELVP05100E	ELVP051G0E	1.160	5	ELVT05500E	ELVT055G0E	1.160	5	ELVT05600E	ELVT056G0E	1.160	5	ELVF05400E	ELVF054G0E	1.160
6	ELVP06100E	ELVP061G0E	1.310	6	ELVT06500E	ELVT065G0E	1.310	6	ELVT06600E	ELVT066G0E	1.310	6	ELVF06400E	ELVF064G0E	1.310
7	ELVP07100E	ELVP071G0E	1.460	7	ELVT07500E	ELVT075G0E	1.460	7	ELVT07600E	ELVT076G0E	1.460	7	ELVF07400E	ELVF074G0E	1.460
8	ELVP08100E	ELVP081G0E	1.610	8	ELVT08500E	ELVT085G0E	1.610	8	ELVT08600E	ELVT086G0E	1.610	8	ELVF08400E	ELVF084G0E	1.610
9	ELVP09100E	ELVP091G0E	1.760	9	ELVT09500E	ELVT095G0E	1.760	9	ELVT09600E	ELVT096G0E	1.760	9	ELVF09400E	ELVF094G0E	1.760
10	ELVP10100E	ELVP101G0E	1.910	10	ELVT10500E	ELVT105G0E	1.910	10	ELVT10600E	ELVT106G0E	1.910	10	ELVF10400E	ELVF104G0E	1.910
11	ELVP11100E	ELVP111G0E	2.060	11	ELVT11500E	ELVT115G0E	2.060	11	ELVT11600E	ELVT116G0E	2.060	11	ELVF11400E	ELVF114G0E	2.060
12	ELVP12100E	ELVP121G0E	2.210	12	ELVT12500E	ELVT125G0E	2.210	12	ELVT12600E	ELVT126G0E	2.210	12	ELVF12400E	ELVF124G0E	2.210
13	ELVP13100E	ELVP131G0E	2.360	13	ELVT13500E	ELVT135G0E	2.360	13	ELVT13600E	ELVT136G0E	2.360	13	ELVF13400E	ELVF134G0E	2.360
14	ELVP14100E	ELVP141G0E	2.510	14	ELVT14500E	ELVT145G0E	2.510	14	ELVT14600E	ELVT146G0E	2.510	14	ELVF14400E	ELVF144G0E	2.510
15	ELVP15100E	ELVP151G0E	2.660	15	ELVT15500E	ELVT155G0E	2.660	15	ELVT15600E	ELVT156G0E	2.660	15	ELVF15400E	ELVF154G0E	2.660
16	ELVP16100E	ELVP161G0E	2.810	16	ELVT16500E	ELVT165G0E	2.810	16	ELVT16600E	ELVT166G0E	2.810	16	ELVF16400E	ELVF164G0E	2.810
17	ELVP17100E	ELVP171G0E	2.960	17	ELVT17500E	ELVT175G0E	2.960	17	ELVT17600E	ELVT176G0E	2.960	17	ELVF17400E	ELVF174G0E	2.960
18	ELVP18100E	ELVP181G0E	3.110	18	ELVT18500E	ELVT185G0E	3.110	18	ELVT18600E	ELVT186G0E	3.110	18	ELVF18400E	ELVF184G0E	3.110
19	ELVP19100E	ELVP191G0E	3.260	19	ELVT19500E	ELVT195G0E	3.260	19	ELVT19600E	ELVT196G0E	3.260	19	ELVF19400E	ELVF194G0E	3.260
20	ELVP20100E	ELVP201G0E	3.410	20	ELVT20500E	ELVT205G0E	3.410	20	ELVT20600E	ELVT206G0E	3.410	20	ELVF20400E	ELVF204G0E	3.410

See page 13 for gold plating and marking option suffixes

SPECIFICATIONS:

Current Rating: 12A
Operating Voltage: 300V
Insulation Resistance: >10³ Megohms
Dielectric Withstanding: <1600V
Wire Pullout Force:
 Per UL 486E, Section 14

MATERIALS:

Housing: Polyamide, UL 94V-0, black or green
Contact: Copper alloy, optional finish
Clamp Screw: Copper alloy, nickel finish
Wire Clamp: Copper alloy, nickel finish
Ear Screw, M2.5: Steel, nickel finish

WIRE INSTALLATION:

Wire Range: #16-28 AWG
Wire Strip Length: 0.25"
Recommended Tightening Torque: 2.2 lb-in. (0.25N-m)

APPROVALS:



Consult factory for specific product recognitions

Amphenol Pcd

.150" (3.81mm)

ELVD 2-TIER STEPPED HEADERS Vertical and Horizontal

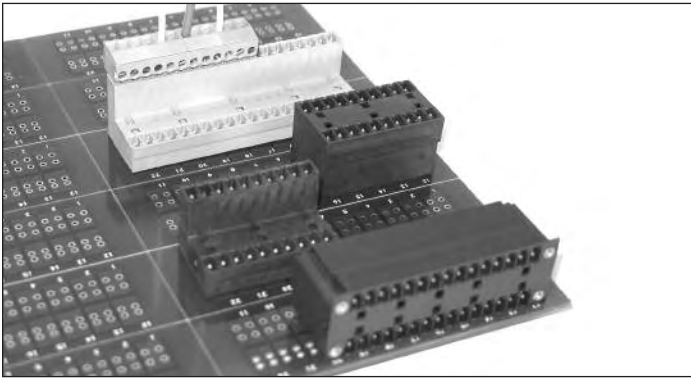

2-TIER HEADERS

High-density ELVD and ELVA 2-tier headers accommodate two PCD ELV or SCVF series plugs in a vertical or horizontal double row configuration.

In-line contact rows and walls provide a compact, rectangular mating face for panel cut-outs and equipment I/O access. Plugs may be installed side-by-side without losing a contact position. Each header row ranges from 2 to 20 poles, providing as many as 40 total circuits. The universal plug interface accepts equivalent competitive plugs, as well as Amphenol Pcd.

SMT Compatibility

The ultra-high-temperature ELVD and ELVA withstand 260°C for three minutes, which allows users to reduce PCB assembly costs by eliminating the need for separate soldering operations for through-hole terminal blocks in SMT boards.

ELVD IN-LINE STEPPED HEADER

ELVD 2-tier headers accept two rows of plugs in an in-line configuration, with the upper row stepped back from the lower for ease of access and wiring.

ELVA IN-LINE STACKED HEADER

ELVA 2-tier in-line headers will accept two plugs in a vertical or horizontal configuration similar to the ELVD, except that the top and bottom contact rows are stacked directly above each other in the same vertical plane. Combined with in-line row configuration and end walls, this makes the ELVA ideally suited for equipment I/O applications.

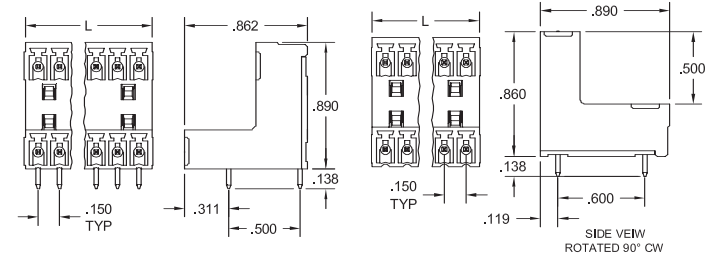
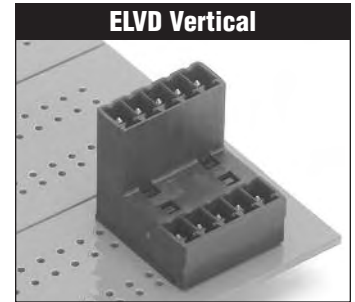
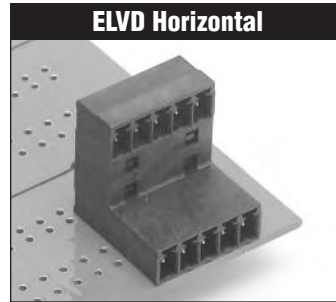

Pos	Catalog # Black	Catalog # Green	L (In.)	Pos	Catalog # Black	Catalog # Green	L (In.)
4	ELVD04100	ELVD041G0	.332	4	ELVD04500	ELVD045G0	0.332
6	ELVD06100	ELVD061G0	.482	6	ELVD06500	ELVD065G0	0.482
8	ELVD08100	ELVD081G0	.632	8	ELVD08500	ELVD085G0	0.632
10	ELVD10100	ELVD101G0	.782	10	ELVD10500	ELVD105G0	0.782
12	ELVD12100	ELVD121G0	.932	12	ELVD12500	ELVD125G0	0.932
14	ELVD14100	ELVD141G0	1.082	14	ELVD14500	ELVD145G0	1.082
16	ELVD16100	ELVD161G0	1.232	16	ELVD16500	ELVD165G0	1.232
18	ELVD18100	ELVD181G0	1.382	18	ELVD18500	ELVD185G0	1.382
20	ELVD20100	ELVD201G0	1.532	20	ELVD20500	ELVD205G0	1.532
22	ELVD22100	ELVD221G0	1.682	22	ELVD22500	ELVD225G0	1.682
24	ELVD24100	ELVD241G0	1.832	24	ELVD24500	ELVD245G0	1.832
26	ELVD26100	ELVD261G0	1.982	26	ELVD26500	ELVD265G0	1.982
28	ELVD28100	ELVD281G0	2.132	28	ELVD28500	ELVD285G0	2.132
30	ELVD30100	ELVD301G0	2.282	30	ELVD30500	ELVD305G0	2.282
32	ELVD32100	ELVD321G0	2.432	32	ELVD32500	ELVD325G0	2.432
34	ELVD34100	ELVD341G0	2.582	34	ELVD34500	ELVD345G0	2.582
36	ELVD36100	ELVD361G0	2.732	36	ELVD36500	ELVD365G0	2.732
38	ELVD38100	ELVD381G0	2.882	38	ELVD38500	ELVD385G0	2.882
40	ELVD40100	ELVD401G0	3.032	40	ELVD40500	ELVD405G0	3.032

See page 13 for gold plating and marking options

APPROVALS:



Consult factory for specific product recognitions

SPECIFICATIONS:

Current Rating: 12A
Operating Voltage: 300V
Insulation Resistance: >10³ Megohms
Dielectric Withstanding: <1600V

MATERIALS:

Housing: Polyamide, UL 94V-0, black or green
Contact: Copper alloy, optional finish

HEADER INSTALLATION:

Hole Diameter: .047"

Amphenol Pcd

ELVA 2-TIER STACKED HEADERS Vertical and Horizontal

.150" (3.81mm)

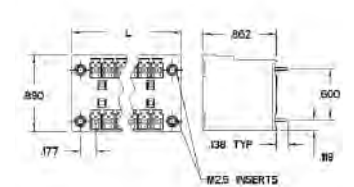
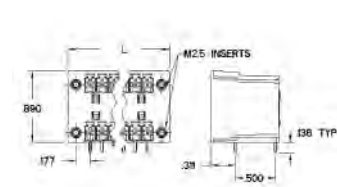
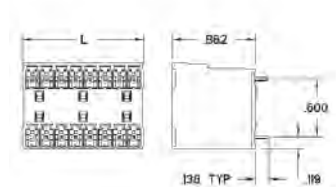
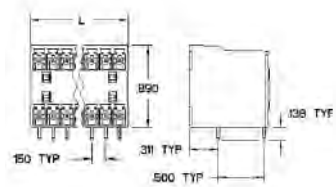
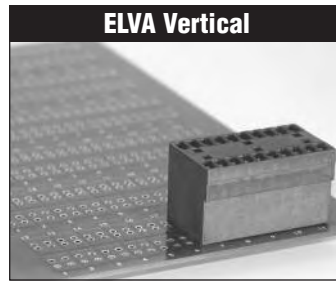
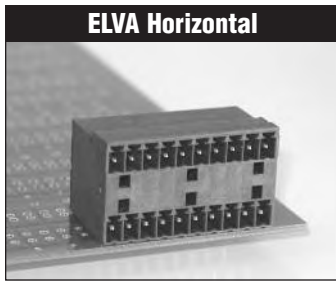

Pos	Catalog # Black	Catalog # Green	L (In.)	Pos	Catalog # Black	Catalog # Green	L (In.)	Pos	Catalog # Black	Catalog # Green	L (In.)	Pos	Catalog # Black	Catalog # Green	L (In.)
4	ELVA04100	ELVA041G0	.332	4	ELVA04500	ELVA045G0	0.332	4	ELVA04100E	ELVA041G0E	0.710	4	ELVA04500E	ELVA045G0E	0.710
6	ELVA06100	ELVA061G0	.482	6	ELVA06500	ELVA065G0	0.482	6	ELVA06100E	ELVA061G0E	0.860	6	ELVA06500E	ELVA065G0E	0.860
8	ELVA08100	ELVA081G0	.632	8	ELVA08500	ELVA085G0	0.632	8	ELVA08100E	ELVA081G0E	1.010	8	ELVA08500E	ELVA085G0E	1.010
10	ELVA10100	ELVA101G0	.782	10	ELVA10500	ELVA105G0	0.782	10	ELVA10100E	ELVA101G0E	1.160	10	ELVA10500E	ELVA105G0E	1.160
12	ELVA12100	ELVA121G0	.932	12	ELVA12500	ELVA125G0	0.932	12	ELVA12100E	ELVA121G0E	1.310	12	ELVA12500E	ELVA125G0E	1.310
14	ELVA14100	ELVA141G0	1.082	14	ELVA14500	ELVA145G0	1.082	14	ELVA14100E	ELVA141G0E	1.460	14	ELVA14500E	ELVA145G0E	1.460
16	ELVA16100	ELVA161G0	1.232	16	ELVA16500	ELVA165G0	1.232	16	ELVA16100E	ELVA161G0E	1.610	16	ELVA16500E	ELVA165G0E	1.610
18	ELVA18100	ELVA181G0	1.382	18	ELVA18500	ELVA185G0	1.382	18	ELVA18100E	ELVA181G0E	1.760	18	ELVA18500E	ELVA185G0E	1.760
20	ELVA20100	ELVA201G0	1.532	20	ELVA20500	ELVA205G0	1.532	20	ELVA20100E	ELVA201G0E	1.910	20	ELVA20500E	ELVA205G0E	1.910
22	ELVA22100	ELVA221G0	1.682	22	ELVA22500	ELVA225G0	1.682	22	ELVA22100E	ELVA221G0E	2.060	22	ELVA22500E	ELVA225G0E	2.060
24	ELVA24100	ELVA241G0	1.832	24	ELVA24500	ELVA245G0	1.832	24	ELVA24100E	ELVA241G0E	2.210	24	ELVA24500E	ELVA245G0E	2.210
26	ELVA26100	ELVA261G0	1.982	26	ELVA26500	ELVA265G0	1.982	26	ELVA26100E	ELVA261G0E	2.360	26	ELVA26500E	ELVA265G0E	2.360
28	ELVA28100	ELVA281G0	2.132	28	ELVA28500	ELVA285G0	2.132	28	ELVA28100E	ELVA281G0E	2.510	28	ELVA28500E	ELVA285G0E	2.510
30	ELVA30100	ELVA301G0	2.282	30	ELVA30500	ELVA305G0	2.282	30	ELVA30100E	ELVA301G0E	2.660	30	ELVA30500E	ELVA305G0E	2.660
32	ELVA32100	ELVA321G0	2.432	32	ELVA32500	ELVA325G0	2.432	32	ELVA32100E	ELVA321G0E	2.810	32	ELVA32500E	ELVA325G0E	2.810
34	ELVA34100	ELVA341G0	2.582	34	ELVA34500	ELVA345G0	2.582	34	ELVA34100E	ELVA341G0E	2.960	34	ELVA34500E	ELVA345G0E	2.960
36	ELVA36100	ELVA361G0	2.732	36	ELVA36500	ELVA365G0	2.732	36	ELVA36100E	ELVA361G0E	3.110	36	ELVA36500E	ELVA365G0E	3.110
38	ELVA38100	ELVA381G0	2.882	38	ELVA38500	ELVA385G0	2.882	38	ELVA38100E	ELVA381G0E	3.260	38	ELVA38500E	ELVA385G0E	3.260
40	ELVA40100	ELVA401G0	3.032	40	ELVA40500	ELVA405G0	3.032	40	ELVA40100E	ELVA401G0E	3.410	40	ELVA40500E	ELVA405G0E	3.410

See page 13 for gold plating and marking option suffixes

SPECIFICATIONS:

Current Rating: 12A
Operating Voltage: 300V
Insulation Resistance: >10³ Megohms
Dielectric Withstanding: <1600V

MATERIALS:

Housing: Polyamide, UL 94V-0, black or green
Contact: Copper alloy, optional finish

HEADER INSTALLATION:

Hole Diameter: .047"

APPROVALS:



Consult factory for specific product recognitions

Amphenol Pcd

The Amphenol Pcd ELF line comprises a family of durable, high-temperature pluggable terminal blocks and headers on .200" and 5.0mm spacing that provide flexible wire-to-board interconnect solutions for a wide variety of applications. ELF design and materials include numerous features and advantages which combine to make this the most advanced pluggable block available. The ELF family is UL, CSA and TUV recognized.

Variations and Configurations

Amphenol Pcd offers a wide selection of ELF variations and accessories on both .200" and 5.0mm spacing, and in 2 through 24 positions. Headers are provided in straight and right angle (vertical and horizontal) configurations; with optional locking, mounting or ejector ears; and in multiple-tier, "stacked", higher-density designs. Plugs are available in numerous configurations, including vertical, horizontal and angled wire entry, and a "front entry" ELFF approach in which both wire insertion and screw actuation are enabled from the front face of the connector, facilitating installation.

The ELF mates interchangeably with .200" and 5.0mm competitive plugs and headers, but offers significant advantages in materials, design and performance.

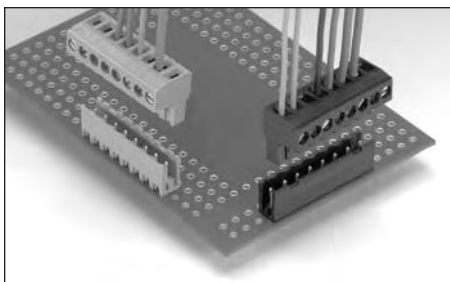

High-Reliability Wire Clamp

A moving vise design clamp ensures high-reliability wire termination by providing a direct, high-pressure connection between contact and wire. When the wire is inserted, a rotating captive screw raises the vise clamp to guarantee a firm connection. The rotating element does not contact the

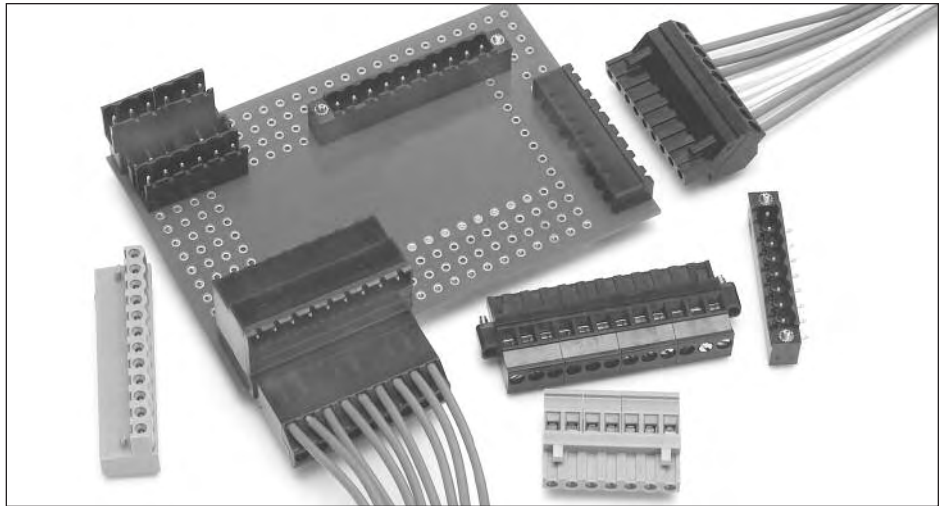

wire, eliminating possible strand damage, and facilitating successive terminations at each contact position.

Smooth Mating/Unmating

Stable materials, precision molding, and a dual beam contact design based on PCD's many years of connector expertise, provide for smooth ELF mating action and reduce the unmating force. Connectors can be separated without undue force and possible header end wall or wire bundle damage.

High Performance Material

ELFH Series headers are precision-molded from tough, stable PBT, providing additional strength and greater reliability under extreme conditions. The use of PBT, with its resistance to moisture absorption, eliminates problems with dimensional stability under the rigors of environmental exposure and contributes to trouble-free mating and unmating.

Wiring While Engaged

Precision molding and component fabrication permit wires to be inserted and removed from individual contact positions while the connectors are mated, without possibility of damage.

Screwdriver Separation

If optional ejector ears are not desired or specified for the equipment design, additional separation ease and safety are provided by molded-in U-shaped slots on the face of the header. Insert a screwdriver, rotate it

90°, and the connector is opened. This feature is particularly important when working with larger terminal block sizes.

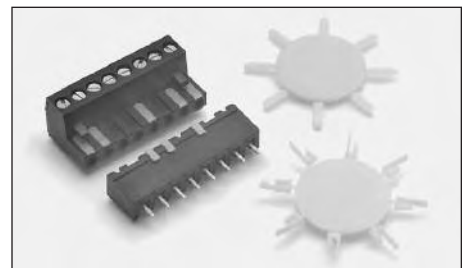

Current Rating

The ELF line has received a 15A UL current rating—the highest in the industry for .200" pluggable blocks. ELF blocks will run cooler than those with lower current ratings—this is a critical basis for reliable, long-term connector performance.

Accessories and Variations

A broad selection of plug and header variations and accessories is readily available to increase the application flexibility of the ELF line. These are outlined below. See pages 25-26 for details.

- SMT Compatibility
- Color
- Gold Plated Contacts
- Locking Ears
- Mounting Ears
- Ejector Ears
- Keying Tabs
- Marking

ELF Accessories and Variations

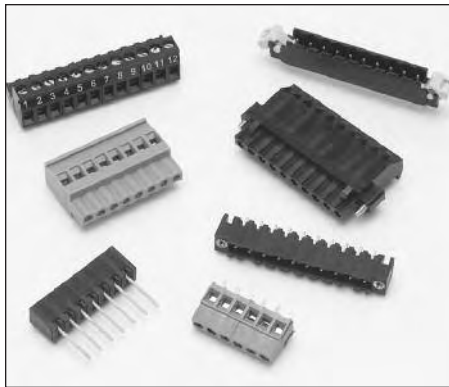

ELF OPTIONS

Optional plug and header accessories and variations, as detailed below, greatly expand the application range and flexibility of the ELF line. Please contact Amphenol Pcd for additional details or application guidance.

SMT Compatibility

ELF headers are also available in ultra-high-temperature glass-filled polyamide, capable of withstanding temperatures of 260°C for three minutes while undergoing SMT reflow soldering. This eliminates the need for a separate header wave soldering operation if SMT is being employed in the board manufacturing process. See the Part Numbering Guides on these pages for ordering information.

Color

The standard color for ELF Series plugs and headers is black, but all ELF products are also available in green—with the same delivery commitment. Catalog numbers for both options are indicated on individual pages throughout. Consult the factory for other colors and color-matching.

Gold Plated Contacts

Standard contact plating is tin-lead. Selectively gold plated contacts—.000030" gold over .000050" nickel—are also available for critical applications involving low-level circuits or severe environmental considerations. See Part Numbering Guides for ordering information.

Locking Ears

Integrally molded locking ears are available with all ELF plug and ELFH header combinations for use in high stress or high vibration applications, or to prevent unintentional disconnect. Plug ears capture a floating, slot-head locking screw that engages a threaded insert on the header ear. The mounting screw is tightened after plug and header are mated, firmly securing the connection.

The plug ear and locking screw can also be used in special applications to secure the plug directly to a bulkhead, if threading provisions are made in the chassis.

To specify locking ears, add "E" as the tenth digit of the catalog number.

Mounting Ears

Header locking ears, with threaded inserts, can also be used as mounting ears to secure headers to PC boards (vertical mount) or chassis.

Alternatively, headers or plugs can be provided with integral mounting ears which feature the same external dimensions as the locking ears, and through-holes for mounting purposes. Contact Amphenol Pcd for details.

Ejector Ear Headers

ELFH Ejector headers, which feature rotating cam ejector ears that are screwdriver- or finger-actuated to smoothly force out and disconnect plugs, are available as another option. Add "J" as a tenth catalog number digit to specify these headers.

MARKING OPTIONS

1 2 3 4 5 6 7
Left to Right - Option "M"

7 6 5 4 3 2 1
Right to Left - Option "A"

↘ ↙ ↕ ↔ ↗ ↖
Top to Bottom - Option "V"

Marking

ELF plugs are available with a variety of marking options (see above). Standard options include left-to-right horizontal numbers ("M" as the ninth digit of the catalog number), right-to-left horizontal numbers ("A") and top-to-bottom vertical numbers ("V").

Please contact Amphenol Pcd to discuss requirements for special plug or header marking.

PLUG PART NUMBERING GUIDE

Note: Not all styles and options are available with all connector types and sizes. Contact the factory to confirm selection.

E L F

TYPE
P = Right Angle
T = Straight
F = Front-Front
K = 45° Angle

POSITIONS
02-24

SPACING
1 = 5.0mm (.197")
2 = .200" (5.08mm)
4 = .300" (7.62mm)

LOCKING EARS
0E = Black / Tin-lead
GE = Green / Tin-lead

OPTIONS
Color / Plating:
0 = Black / Tin-lead
1 = Black / Gold
G = Green / Tin-lead
1G = Green / Gold

Marking:
M = Left-to-Right
A = Right-to-Left
V = Top-to-Bottom

STYLE
(See individual product pages)

ELF Accessories and Variations

Marking Labels

Stick-on marking labels for .200" and 5.0mm spacing, printed on a vinyl cloth sheet, are available in five versions; each sheet containing 25 peel-off strips, and each strip with twelve sequential position numbers. See page 29 for catalog number and ordering guidance.

Keying

ELF plugs and headers are designed to accept tabs that lock into keyways in the insulator body, and can be configured to ensure correct mating of physically similar, but electrically unique connector elements in a complex system. The bright yellow tabs provide a visual confirmation of correct mating as well as a physical guarantee.

Connectors to be keyed are configured with an appropriate number of keying tabs, so that plugs are prevented from entering the wrong header. See page 29 for catalog number and ordering guidance.

Part Numbering Guides

Consult the factory in cases where certain option combinations present a conflict in designating a part number.

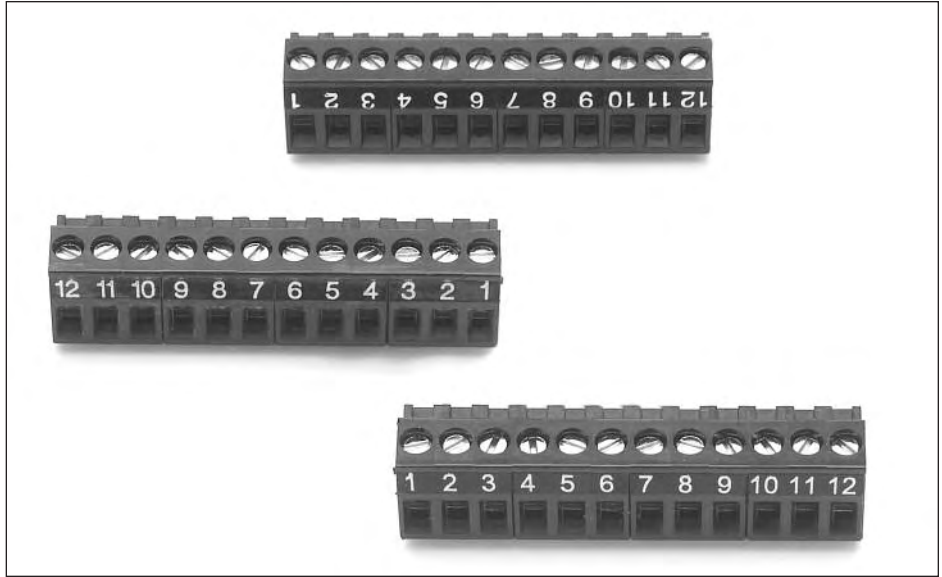

SPECIAL ELF VARIATIONS

In addition to the more standard ELF product variations indicated in this catalog, Amphenol Pcd is the industry leader in providing custom PCB block configurations tailored to meet special application or unusual system demands, and unique identification or capability requirements.

In-house engineering and manufacturing capabilities are geared to responsiveness, product flexibility and focus

on customer oriented development and innovation. Amphenol Pcd welcomes inquiries for non-standard product variations.

.150" DESIGN ON .200" CENTERS

Plugs and mating headers which feature the same basic shrouded contact design of the .150" ELV family, but on .200" centers—providing greater anti-cocking protection and extended creepage distance—are available as ELWF "Front-Front" plugs and and ELWH headers. Contact the factory for details

.400"/10.0mm—ELL SERIES

All .200"/5.0mm ELF plugs and headers are also available on .400"/10.0mm spacing for power or other special applications. See page 53 for details.

SELECTIVE LOADING

ELF plugs and headers are available with contacts selectively loaded to user application requirements.

HEADER PART NUMBERING GUIDE

Note: Not all styles and options are available with all connector types and sizes. Contact the factory to confirm selection.

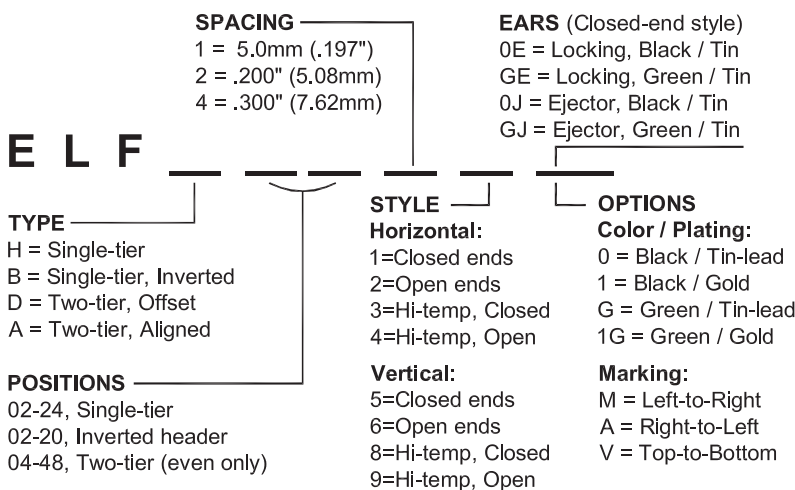

ELFP-P PLUGS WITH STRAIN RELIEF Right Angle

.200" (5.08mm)
5.0mm (.197")



STRAIN RELIEF

ELFP-P right angle plugs with integral wire strain relief provide users with additional installation control and security for critical applications where the wire bundle may be stressed. Standard cable ties are utilized to secure wire bundles to an integral mounting tab which extends from the plug body.

Plugs are available both with and without locking ears.

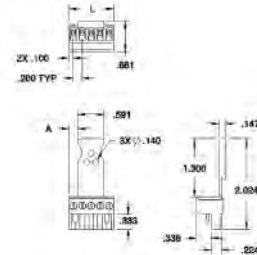
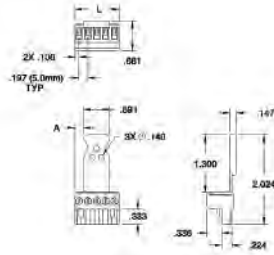

Pos	Catalog #		L (mm)	Pos	Catalog #		L (in.)
	Black	Green			Black	Green	
3	ELFP0311P0	ELFP0311PG	15.0	3	ELFP0321P0	ELFP0321PG	.600
4	ELFP0411P0	ELFP0411PG	20.0	4	ELFP0421P0	ELFP0421PG	.800
5	ELFP0511P0	ELFP0511PG	25.0	5	ELFP0521P0	ELFP0521PG	1.000
6	ELFP0611P0	ELFP0611PG	30.0	6	ELFP0621P0	ELFP0621PG	1.200
7	ELFP0711P0	ELFP0711PG	35.0	7	ELFP0721P0	ELFP0721PG	1.400

ELFP-P—5.00MM—EARED

ELFP-P—.200"—EARED

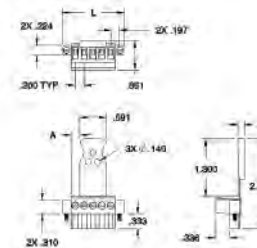

Pos	Catalog #		L (mm)	Pos	Catalog #		L (in.)
	Black	Green			Black	Green	
3	ELFP0311P0E	ELFP0311PGE	15.0	3	ELFP0321P0E	ELFP0321PGE	1.00
4	ELFP0411P0E	ELFP0411PGE	20.0	4	ELFP0421P0E	ELFP0421PGE	1.20
5	ELFP0511P0E	ELFP0511PGE	25.0	5	ELFP0521P0E	ELFP0521PGE	1.40
6	ELFP0611P0E	ELFP0611PGE	30.0	6	ELFP0621P0E	ELFP0621PGE	1.60
7	ELFP0711P0E	ELFP0711PGE	35.0	7	ELFP0721P0E	ELFP0721PGE	1.80

SPECIFICATIONS:

Current Rating: 15A
Operating Voltage: 300V
Insulation Resistance: >105 Megohms
Dielectric Withstanding: <3000V
Wire Pullout Force:
 Per UL 486E, Section 14

MATERIALS:

Housing: PPO, UL 94V-0, Black or green
Contact: Copper alloy, optional finish
Clamp Screw: Steel, nickel finish
Wire Clamp: Copper alloy, nickel finish

INSTALLATION:

Wire Range: 12-26 AWG
Wire Strip Length: .310"
Tightening Torque: 7 lb-in. (0.79N-m)

APPROVALS:



Consult factory for specific product recognitions

Amphenol Pcd



PLUGS

ELF Series plugs mate with ELF Series headers, and accommodate competitive headers as well. Precision molded housings allow wire termination while the connector is either plugged or unplugged.

ELFP blocks feature wire entry parallel to contact and mating direction.

ELFT blocks offer top or bottom wire entry perpendicular to contact and mating direction.

ELFF "front-front" blocks feature wire insertion and screw actuation from the front of the plug—plus a top or bottom wire entry option.

Locking Ears: See pages 30-31

Gold Plating: Indicate "1" as the last digit of catalog no. for black parts; "1G" in the last position for green parts.

Marking: See page 25

Accessories: Polarizing keys and marking labels. See page 29.

Pos	Catalog #		L (mm)	Pos	Catalog #		L (mm)	Pos	Catalog #		L (mm)
	Black	Green			Black	Green			Black	Green	
2	ELFP02110	ELFP0211G	10	2	ELFT02150	ELFT0215G	10	2	ELFT02160	ELFT0216G	10
3	ELFP03110	ELFP0311G	15	3	ELFT03150	ELFT0315G	15	3	ELFT03160	ELFT0316G	15
4	ELFP04110	ELFP0411G	20	4	ELFT04150	ELFT0415G	20	4	ELFT04160	ELFT0416G	20
5	ELFP05110	ELFP0511G	25	5	ELFT05150	ELFT0515G	25	5	ELFT05160	ELFT0516G	25
6	ELFP06110	ELFP0611G	30	6	ELFT06150	ELFT0615G	30	6	ELFT06160	ELFT0616G	30
7	ELFP07110	ELFP0711G	35	7	ELFT07150	ELFT0715G	35	7	ELFT07160	ELFT0716G	35
8	ELFP08110	ELFP0811G	40	8	ELFT08150	ELFT0815G	40	8	ELFT08160	ELFT0816G	40
9	ELFP09110	ELFP0911G	45	9	ELFT09150	ELFT0915G	45	9	ELFT09160	ELFT0916G	45
10	ELFP10110	ELFP1011G	50	10	ELFT10150	ELFT1015G	50	10	ELFT10160	ELFT1016G	50
11	ELFP11110	ELFP1111G	55	11	ELFT11150	ELFT1115G	55	11	ELFT11160	ELFT1116G	55
12	ELFP12110	ELFP1211G	60	12	ELFT12150	ELFT1215G	60	12	ELFT12160	ELFT1216G	60
13	ELFP13110	ELFP1311G	65	13	ELFT13150	ELFT1315G	65	13	ELFT13160	ELFT1316G	65
14	ELFP14110	ELFP1411G	70	14	ELFT14150	ELFT1415G	70	14	ELFT14160	ELFT1416G	70
15	ELFP15110	ELFP1511G	75	15	ELFT15150	ELFT1515G	75	15	ELFT15160	ELFT1516G	75
16	ELFP16110	ELFP1611G	80	16	ELFT16150	ELFT1615G	80	16	ELFT16160	ELFT1616G	80
17	ELFP17110	ELFP1711G	85	17	ELFT17150	ELFT1715G	85	17	ELFT17160	ELFT1716G	85
18	ELFP18110	ELFP1811G	90	18	ELFT18150	ELFT1815G	90	18	ELFT18160	ELFT1816G	90
19	ELFP19110	ELFP1911G	95	19	ELFT19150	ELFT1915G	95	19	ELFT19160	ELFT1916G	95
20	ELFP20110	ELFP2011G	100	20	ELFT20150	ELFT2015G	100	20	ELFT20160	ELFT2016G	100
21	ELFP21110	ELFP2111G	105	21	ELFT21150	ELFT2115G	105	21	ELFT21160	ELFT2116G	105
22	ELFP22110	ELFP2211G	110	22	ELFT22150	ELFT2215G	150	22	ELFT22160	ELFT2216G	110
23	ELFP23110	ELFP2311G	115	23	ELFT23150	ELFT2315G	155	23	ELFT23160	ELFT2316G	115
24	ELFP24110	ELFP2411G	120	24	ELFT24150	ELFT2415G	120	24	ELFT24160	ELFT2416G	120

See page 25 for gold plating and marking options

APPROVALS:



Consult factory for specific product recognitions

SPECIFICATIONS:

Current Rating: 15A
Operating Voltage: 300V
Insulation Resistance: >10⁵ Megohms
Dielectric Withstanding: <3000V
Wire Pullout Force:
 Per UL 486E, Section 14

MATERIALS:

Housing: PPO, UL 94V-0, Black or green
Contact: Copper alloy, optional finish
Clamp Screw: Steel, nickel finish
Wire clamp: Copper alloy, nickel finish

INSTALLATION:

Wire Range: 12-26 AWG
Wire Strip Length: .310"
Recommended Tightening Torque:
 7 lb-in. (0.79N-m)

ELFF PLUGS Front Entry

5.0mm (.197")



Pos	Catalog # Black	Catalog # Green	L (mm)	Pos	Catalog # Black	Catalog # Green	L (mm)
2	ELFF02130	ELFF0213G	10	2	ELFF02140	ELFF0214G	10
3	ELFF03130	ELFF0313G	15	3	ELFF03140	ELFF0314G	15
4	ELFF04130	ELFF0413G	20	4	ELFF04140	ELFF0414G	20
5	ELFF05130	ELFF0513G	25	5	ELFF05140	ELFF0514G	25
6	ELFF06130	ELFF0613G	30	6	ELFF06140	ELFF0614G	30
7	ELFF07130	ELFF0713G	35	7	ELFF07140	ELFF0714G	35
8	ELFF08130	ELFF0813G	40	8	ELFF08140	ELFF0814G	40
9	ELFF09130	ELFF0913G	45	9	ELFF09140	ELFF0914G	45
10	ELFF10130	ELFF1013G	50	10	ELFF10140	ELFF1014G	50
11	ELFF11130	ELFF1113G	55	11	ELFF11140	ELFF1114G	55
12	ELFF12130	ELFF1213G	60	12	ELFF12140	ELFF1214G	60
13	ELFF13130	ELFF1313G	65	13	ELFF13140	ELFF1314G	65
14	ELFF14130	ELFF1413G	70	14	ELFF14140	ELFF1414G	70
15	ELFF15130	ELFF1513G	75	15	ELFF15140	ELFF1514G	75
16	ELFF16130	ELFF1613G	80	16	ELFF16140	ELFF1614G	80
17	ELFF17130	ELFF1713G	85	17	ELFF17140	ELFF1714G	85
18	ELFF18130	ELFF1813G	90	18	ELFF18140	ELFF1814G	90
19	ELFF19130	ELFF1913G	95	19	ELFF19140	ELFF1914G	95
20	ELFF20130	ELFF2013G	100	20	ELFF20140	ELFF2014G	100
21	ELFF21130	ELFF2113G	105	21	ELFF21140	ELFF2114G	105
22	ELFF22130	ELFF2213G	110	22	ELFF22140	ELFF2214G	110
23	ELFF23130	ELFF2313G	115	23	ELFF23140	ELFF2314G	115
24	ELFF24130	ELFF2413G	120	24	ELFF24140	ELFF2414G	120

See page 25 for gold plating and marking options

SPECIFICATIONS:

Current Rating: 15A
Operating Voltage: 300V
Insulation Resistance: >10⁵ Megohms
Dielectric Withstanding: <3000V
Wire Pullout Force:
 Per UL 486E, Section 14

MATERIALS:

Housing: PPO, UL 94V-0, Black or green
Contact: Copper alloy, optional finish
Clamp Screw: Steel, nickel finish
Wire clamp: Copper alloy, nickel finish

INSTALLATION:

Wire Range: 12-26 AWG
Wire Strip Length: .310" (14-26 AWG),
 .490" (12 AWG)
Recommended Tightening Torque:
 7 lb-in. (0.79N-m)

APPROVALS:



Consult factory for specific product recognitions

POLARIZING KEYS FOR ELF FAMILY

ELF plugs and headers are designed to accept tabs which lock into keyways in the body moldings, and can be configured to ensure correct mating of physically similar but electrically unique connectors—and to prevent incorrect mating of the wrong connectors.

Keying is accomplished without loss of a contact position.

Connectors to be keyed are configured with an appropriate number and combination of tabs in plug and header so that plugs are prevented from entering the wrong header. The bright yellow tabs provide a visual and physical confirmation of correct mating.

The identical keying system is also utilized for FXP FlexiPlug hybrid plugs, in combination with ELFH headers.

For handling convenience, keys are supplied in rings of eight. Order Part No. 300800000 for plug keys and 300800820 for header keys.

MARKING LABELS

Stick-on marking labels, printed on vinyl cloth, are available in two versions:

ELFLABEL1: Nos. 1-12
 ELFLABEL2: Nos. 13-24

Labels are supplied in sheets containing 25 peel-off strips.

Amphenol Pcd

ELFP/T PLUGS with LOCKING EARS Right Angle/Straight



ELF SERIES PLUGS WITH LOCKING EARS

These two pages present the locking ear versions of the 5.0mm spacing plugs depicted on pages 28 and 29—an “E” is added to the catalog number (see page 25). Note: locking ears add one contact position in length to each end of the plug.

The integrally molded locking ears are available with ELFP, ELFT and ELFF plugs and all ELFH series headers. Plug ears capture a floating, slot-head locking screw that engages a threaded insert on the header ear. The mounting screw is tightened after plug and header are mated, firmly securing the connection.

Gold Plating: Contact PCD for part number guidance.

Marking: See page 25

Accessories: Polarizing keys and marking labels. See page 29.

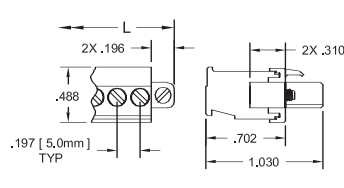
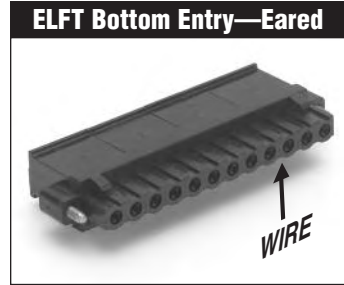
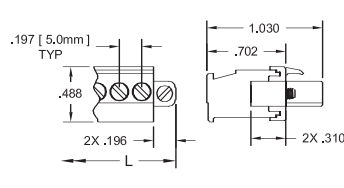
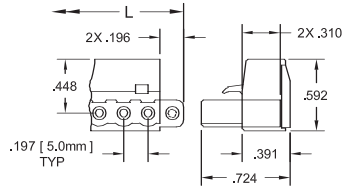

Pos	Catalog # Black	Catalog # Green	L (mm)	Pos	Catalog # Black	Catalog # Green	L (mm)	Pos	Catalog # Black	Catalog # Green	L (mm)
2	ELFP02110E	ELFP0211GE	20	2	ELFT02150E	ELFT0215GE	20	2	ELFT02160E	ELFT0216GE	20
3	ELFP03110E	ELFP0311GE	25	3	ELFT03150E	ELFT0315GE	25	3	ELFT03160E	ELFT0316GE	25
4	ELFP04110E	ELFP0411GE	30	4	ELFT04150E	ELFT0415GE	30	4	ELFT04160E	ELFT0416GE	30
5	ELFP05110E	ELFP0511GE	35	5	ELFT05150E	ELFT0515GE	35	5	ELFT05160E	ELFT0516GE	35
6	ELFP06110E	ELFP0611GE	40	6	ELFT06150E	ELFT0615GE	40	6	ELFT06160E	ELFT0616GE	40
7	ELFP07110E	ELFP0711GE	45	7	ELFT07150E	ELFT0715GE	45	7	ELFT07160E	ELFT0716GE	45
8	ELFP08110E	ELFP0811GE	50	8	ELFT08150E	ELFT0815GE	50	8	ELFT08160E	ELFT0816GE	50
9	ELFP09110E	ELFP0911GE	55	9	ELFT09150E	ELFT0915GE	55	9	ELFT09160E	ELFT0916GE	55
10	ELFP10110E	ELFP1011GE	60	10	ELFT10150E	ELFT1015GE	60	10	ELFT10160E	ELFT1016GE	60
11	ELFP11110E	ELFP1111GE	65	11	ELFT11150E	ELFT1115GE	65	11	ELFT11160E	ELFT1116GE	65
12	ELFP12110E	ELFP1211GE	70	12	ELFT12150E	ELFT1215GE	70	12	ELFT12160E	ELFT1216GE	70
13	ELFP13110E	ELFP1311GE	75	13	ELFT13150E	ELFT1315GE	75	13	ELFT13160E	ELFT1316GE	75
14	ELFP14110E	ELFP1411GE	80	14	ELFT14150E	ELFT1415GE	80	14	ELFT14160E	ELFT1416GE	80
15	ELFP15110E	ELFP1511GE	85	15	ELFT15150E	ELFT1515GE	85	15	ELFT15160E	ELFT1516GE	85
16	ELFP16110E	ELFP1611GE	90	16	ELFT16150E	ELFT1615GE	90	16	ELFT16160E	ELFT1616GE	90
17	ELFP17110E	ELFP1711GE	95	17	ELFT17150E	ELFT1715GE	95	17	ELFT17160E	ELFT1716GE	95
18	ELFP18110E	ELFP1811GE	100	18	ELFT18150E	ELFT1815GE	100	18	ELFT18160E	ELFT1816GE	100
19	ELFP19110E	ELFP1911GE	105	19	ELFT19150E	ELFT1915GE	105	19	ELFT19160E	ELFT1916GE	105
20	ELFP20110E	ELFP2011GE	110	20	ELFT20150E	ELFT2015GE	110	20	ELFT20160E	ELFT2016GE	110
21	ELFP21110E	ELFP2111GE	115	21	ELFT21150E	ELFT2115GE	115	21	ELFT21160E	ELFT2116GE	115
22	ELFP22110E	ELFP2211GE	120	22	ELFT22150E	ELFT2215GE	120	22	ELFT22160E	ELFT2216GE	120

See page 25 for gold plating and marking options

APPROVALS:



Consult factory for specific product recognitions

SPECIFICATIONS:

- Current Rating:** 15A
- Operating Voltage:** 300V
- Insulation Resistance:** >10⁵ Megohms
- Dielectric Withstanding:** <3000V
- Wire Pullout Force:** Per UL 486E, Section 14

MATERIALS:

- Housing:** PPO, UL 94V-0, Black or green
- Contact:** Copper alloy, optional finish
- Clamp Screw:** Steel, nickel finish
- Wire clamp:** Copper alloy, nickel finish
- Ear Screw, M2.5:** Steel, nickel finish

INSTALLATION:

- Wire Range:** 12-26 AWG
- Wire Strip Length:** .310"
- Recommended Tightening Torque:** 7 lb-in. (0.79N-m)

ELFF PLUGS with LOCKING EARS Front Entry

5.0mm (.197")

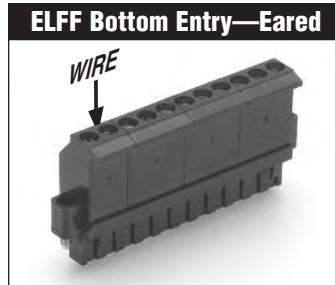

Pos	Catalog # Black	Catalog # Green	L (mm)	Pos	Catalog # Black	Catalog # Green	L (mm)
2	ELFF02130E	ELFF0213GE	20	2	ELFF02140E	ELFF0214GE	20
3	ELFF03130E	ELFF0313GE	25	3	ELFF03140E	ELFF0314GE	25
4	ELFF04130E	ELFF0413GE	30	4	ELFF04140E	ELFF0414GE	30
5	ELFF05130E	ELFF0513GE	35	5	ELFF05140E	ELFF0514GE	35
6	ELFF06130E	ELFF0613GE	40	6	ELFF06140E	ELFF0614GE	40
7	ELFF07130E	ELFF0713GE	45	7	ELFF07140E	ELFF0714GE	45
8	ELFF08130E	ELFF0813GE	50	8	ELFF08140E	ELFF0814GE	50
9	ELFF09130E	ELFF0913GE	55	9	ELFF09140E	ELFF0914GE	55
10	ELFF10130E	ELFF1013GE	60	10	ELFF10140E	ELFF1014GE	60
11	ELFF11130E	ELFF1113GE	65	11	ELFF11140E	ELFF1114GE	65
12	ELFF12130E	ELFF1213GE	70	12	ELFF12140E	ELFF1214GE	70
13	ELFF13130E	ELFF1313GE	75	13	ELFF13140E	ELFF1314GE	75
14	ELFF14130E	ELFF1413GE	80	14	ELFF14140E	ELFF1414GE	80
15	ELFF15130E	ELFF1513GE	85	15	ELFF15140E	ELFF1514GE	85
16	ELFF16130E	ELFF1613GE	90	16	ELFF16140E	ELFF1614GE	90
17	ELFF17130E	ELFF1713GE	95	17	ELFF17140E	ELFF1714GE	95
18	ELFF18130E	ELFF1813GE	100	18	ELFF18140E	ELFF1814GE	100
19	ELFF19130E	ELFF1913GE	105	19	ELFF19140E	ELFF1914GE	105
20	ELFF20130E	ELFF2013GE	110	20	ELFF20140E	ELFF2014GE	110
21	ELFF21130E	ELFF2113GE	115	21	ELFF21140E	ELFF2114GE	115
22	ELFF22130E	ELFF2213GE	120	22	ELFF22140E	ELFF2214GE	120

See page 25 for gold plating and marking options

SPECIFICATIONS:

Current Rating: 15A
Operating Voltage: 300V
Insulation Resistance: >10⁵ Megohms
Dielectric Withstanding: <3000V
Wire Pullout Force: Per UL 486E, Section 14

MATERIALS:

Housing: PPO, UL 94V-0, Black or green
Contact: Copper alloy, optional finish
Clamp Screw: Steel, nickel finish
Wire clamp: Copper alloy, nickel finish
Ear Screw, M2.5: Steel, nickel finish

INSTALLATION:

Wire Range: 12-26 AWG
Wire Strip Length: .310" (14-26 AWG),
.490" (12 AWG)
Recommended Tightening Torque:
7 lb-in. (0.79N-m)

APPROVALS:



Consult factory for specific product recognitions

Amphenol Pcd

ELFH HEADERS with Locking Ears

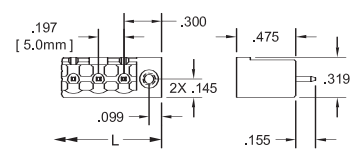
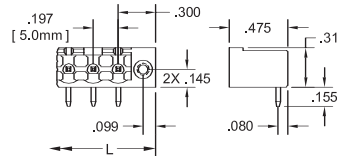
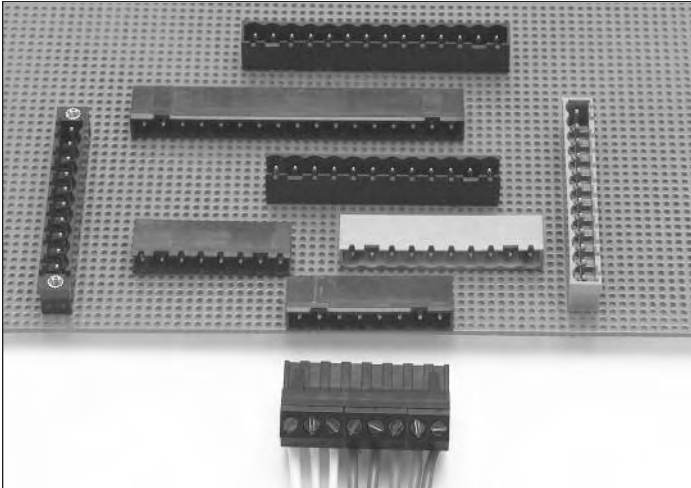

ELFH SERIES HEADERS

ELFH Series headers mate with ELF Series plugs and accommodate competitive plugs as well. The headers are precision-molded from tough, stable PBT, providing additional strength and greater reliability under extreme conditions.

SMT Compatibility

ELF headers are available in ultra-high-temperature, glass-filled polyamide, capable of withstanding temperatures of 260°C for three minutes while undergoing SMT reflow soldering. This eliminates the need for a separate header wave soldering operation if SMT is being employed in the board manufacturing process. See page 26 for instructions on how to order. Note: Available in black only.

Accessories: Polarizing keys and marking labels. See page 29.

Locking and Mounting Ears

Integrally molded locking ears are available with all ELFH headers. A threaded insert in the header ear is engaged by a plug mounting screw, which is tightened after plug and header are mated, securing the connection. Note: locking ears add a contact position per side to header length.

An "E" is added to the catalog number to specify locking ears.

Locking ears can also be used as mounting ears to secure the header to printed circuit boards or chassis, and are available as well with blank through-holes in the "vertical" orientation for custom mounting.

Gold Plating: Indicate "1" as the last digit of catalog no. for black parts; "1G" in the last position for green parts. Consult PCD for assistance with locking-ear headers.

Marking: See page 25.

Pos	Catalog # Black	Catalog # Green	L (mm)	Pos	Catalog # Black	Catalog # Green	L (mm)
2	ELFH02110E	ELFH0211GE	20	2	ELFH02150E	ELFH0215GE	20
3	ELFH03110E	ELFH0311GE	25	3	ELFH03150E	ELFH0315GE	25
4	ELFH04110E	ELFH0411GE	30	4	ELFH04150E	ELFH0415GE	30
5	ELFH05110E	ELFH0511GE	35	5	ELFH05150E	ELFH0515GE	35
6	ELFH06110E	ELFH0611GE	40	6	ELFH06150E	ELFH0615GE	40
7	ELFH07110E	ELFH0711GE	45	7	ELFH07150E	ELFH0715GE	45
8	ELFH08110E	ELFH0811GE	50	8	ELFH08150E	ELFH0815GE	50
9	ELFH09110E	ELFH0911GE	55	9	ELFH09150E	ELFH0915GE	55
10	ELFH10110E	ELFH1011GE	60	10	ELFH10150E	ELFH1015GE	60
11	ELFH11110E	ELFH1111GE	65	11	ELFH11150E	ELFH1115GE	65
12	ELFH12110E	ELFH1211GE	70	12	ELFH12150E	ELFH1215GE	70
13	ELFH13110E	ELFH1311GE	75	13	ELFH13150E	ELFH1315GE	75
14	ELFH14110E	ELFH1411GE	80	14	ELFH14150E	ELFH1415GE	80
15	ELFH15110E	ELFH1511GE	85	15	ELFH15150E	ELFH1515GE	85
16	ELFH16110E	ELFH1611GE	90	16	ELFH16150E	ELFH1615GE	90
17	ELFH17110E	ELFH1711GE	95	17	ELFH17150E	ELFH1715GE	95
18	ELFH18110E	ELFH1811GE	100	18	ELFH18150E	ELFH1815GE	100
19	ELFH19110E	ELFH1911GE	105	19	ELFH19150E	ELFH1915GE	105
20	ELFH20110E	ELFH2011GE	110	20	ELFH20150E	ELFH2015GE	110
21	ELFH21110E	ELFH2111GE	115	21	ELFH21150E	ELFH2115GE	115
22	ELFH22110E	ELFH2211GE	120	22	ELFH22150E	ELFH2215GE	120

See page 25 for hi-temp, gold plating and marking options

APPROVALS:



Consult factory for specific product recognitions

SPECIFICATIONS:

Current Rating: 15A
Operating Voltage: 300V
Insulation Resistance: >10⁵ Megohms
Dielectric Withstanding: <3000V

HEADER INSTALLATION:

Hole Diameter: .055" min.

MATERIALS:

Housing: PBT, UL 94V-0 (Standard)
 PA 46, UL 94V-0 (High temp)
 Black or green optional
Contact: Copper alloy, optional finish
Ear Insert, M2.5: Brass, nickel finish

ELFH HEADERS



Pos	Catalog # Black	Catalog # Green	L (mm)	Pos	Catalog # Black	Catalog # Green	L (mm)	Pos	Catalog # Black	Catalog # Green	L (mm)	Pos	Catalog # Black	Catalog # Green	L (mm)
2	ELFH02110	ELFH0211G	10	2	ELFH02150	ELFH0215G	10	2	ELFH02120	ELFH0212G	10	2	ELFH02160	ELFH0216G	10
3	ELFH03110	ELFH0311G	15	3	ELFH03150	ELFH0315G	15	3	ELFH03120	ELFH0312G	15	3	ELFH03160	ELFH0316G	15
4	ELFH04110	ELFH0411G	20	4	ELFH04150	ELFH0415G	20	4	ELFH04120	ELFH0412G	20	4	ELFH04160	ELFH0416G	20
5	ELFH05110	ELFH0511G	25	5	ELFH05150	ELFH0515G	25	5	ELFH05120	ELFH0512G	25	5	ELFH05160	ELFH0516G	25
6	ELFH06110	ELFH0611G	30	6	ELFH06150	ELFH0615G	30	6	ELFH06120	ELFH0612G	30	6	ELFH06160	ELFH0616G	30
7	ELFH07110	ELFH0711G	35	7	ELFH07150	ELFH0715G	35	7	ELFH07120	ELFH0712G	35	7	ELFH07160	ELFH0716G	35
8	ELFH08110	ELFH0811G	40	8	ELFH08150	ELFH0815G	40	8	ELFH08120	ELFH0812G	40	8	ELFH08160	ELFH0816G	40
9	ELFH09110	ELFH0911G	45	9	ELFH09150	ELFH0915G	45	9	ELFH09120	ELFH0912G	45	9	ELFH09160	ELFH0916G	45
10	ELFH10110	ELFH1011G	50	10	ELFH10150	ELFH1015G	50	10	ELFH10120	ELFH1012G	50	10	ELFH10160	ELFH1016G	50
11	ELFH11110	ELFH1111G	55	11	ELFH11150	ELFH1115G	55	11	ELFH11120	ELFH1112G	55	11	ELFH11160	ELFH1116G	55
12	ELFH12110	ELFH1211G	60	12	ELFH12150	ELFH1215G	60	12	ELFH12120	ELFH1212G	60	12	ELFH12160	ELFH1216G	60
13	ELFH13110	ELFH1311G	65	13	ELFH13150	ELFH1315G	65	13	ELFH13120	ELFH1312G	65	13	ELFH13160	ELFH1316G	65
14	ELFH14110	ELFH1411G	70	14	ELFH14150	ELFH1415G	70	14	ELFH14120	ELFH1412G	70	14	ELFH14160	ELFH1416G	70
15	ELFH15110	ELFH1511G	75	15	ELFH15150	ELFH1515G	75	15	ELFH15120	ELFH1512G	75	15	ELFH15160	ELFH1516G	75
16	ELFH16110	ELFH1611G	80	16	ELFH16150	ELFH1615G	80	16	ELFH16120	ELFH1612G	80	16	ELFH16160	ELFH1616G	80
17	ELFH17110	ELFH1711G	85	17	ELFH17150	ELFH1715G	85	17	ELFH17120	ELFH1712G	85	17	ELFH17160	ELFH1716G	85
18	ELFH18110	ELFH1811G	90	18	ELFH18150	ELFH1815G	90	18	ELFH18120	ELFH1812G	90	18	ELFH18160	ELFH1816G	90
19	ELFH19110	ELFH1911G	95	19	ELFH19150	ELFH1915G	95	19	ELFH19120	ELFH1912G	95	19	ELFH19160	ELFH1916G	95
20	ELFH20110	ELFH2011G	100	20	ELFH20150	ELFH2015G	100	20	ELFH20120	ELFH2012G	100	20	ELFH20160	ELFH2016G	100
21	ELFH21110	ELFH2111G	105	21	ELFH21150	ELFH2115G	105	21	ELFH21120	ELFH2112G	105	21	ELFH21160	ELFH2116G	105
22	ELFH22110	ELFH2211G	110	22	ELFH22150	ELFH2215G	110	22	ELFH22120	ELFH2212G	110	22	ELFH22160	ELFH2216G	110
23	ELFH23110	ELFH2311G	115	23	ELFH23150	ELFH2315G	115	23	ELFH23120	ELFH2312G	115	23	ELFH23160	ELFH2316G	115
24	ELFH24110	ELFH2411G	120	24	ELFH24150	ELFH2415G	120	24	ELFH24120	ELFH2412G	120	24	ELFH24160	ELFH2416G	120

See page 25 for hi-temp, gold plating and marking options

SPECIFICATIONS:

Current Rating: 15A
Operating Voltage: 300V
Insulation Resistance: >10⁵ Megohms
Dielectric Withstanding: <3000V

HEADER INSTALLATION:

Hole Diameter: .055" min.

MATERIALS:

Housing: PBT, UL 94V-0 (Standard)
 PA 46, UL 94V-0 (High temp)
 Black (Green option standard only)
Contact: Copper alloy, optional finish

APPROVALS:



Consult factory for specific product recognitions

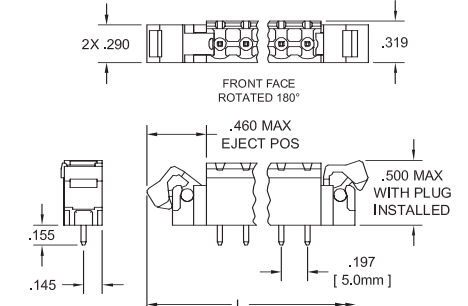
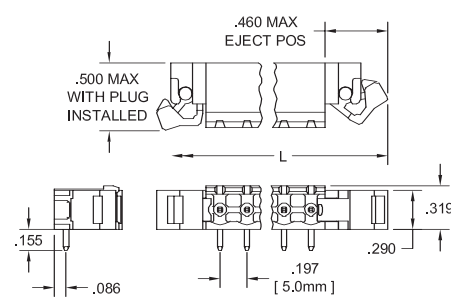
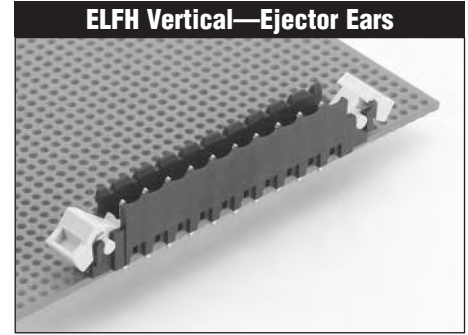
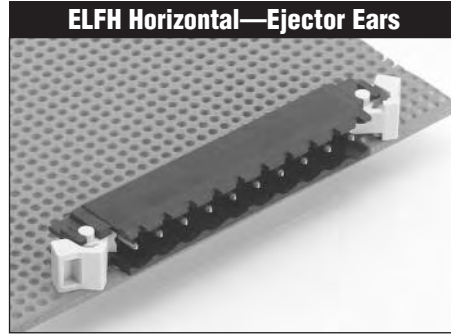
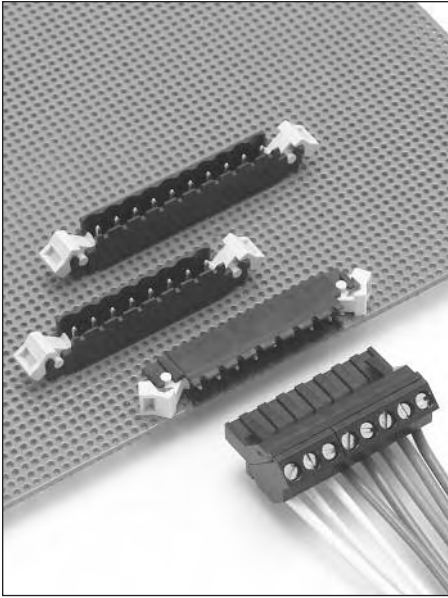

EJECTOR EAR HEADERS

The ELFH Series ejector ear header allows for plug disconnect with a minimal amount of effort by way of screwdriver or finger actuation of the levered ears.

The universal design accepts ELF Series plugs. It is currently available in 8 through 22 positions, in both .200" and 5.0mm spacing. Ejector ear headers can also be provided with the ELFH Series gold plating option.

The following options comprise the standard color combinations for ejector ear headers:

- Black header, gray ears
- Green header, black ears

Pos	Catalog # Black	Catalog # Green	L (mm)	Pos	Catalog # Black	Catalog # Green	L (mm)
8	ELFH08110J	ELFH0811GJ	63.52	8	ELFH08150J	ELFH0815GJ	63.52
9	ELFH09110J	ELFH0911GJ	68.52	9	ELFH09150J	ELFH0915GJ	68.52
10	ELFH10110J	ELFH1011GJ	73.52	10	ELFH10150J	ELFH1015GJ	73.52
11	ELFH11110J	ELFH1111GJ	78.52	11	ELFH11150J	ELFH1115GJ	78.52
12	ELFH12110J	ELFH1211GJ	83.52	12	ELFH12150J	ELFH1215GJ	83.52
13	ELFH13110J	ELFH1311GJ	88.52	13	ELFH13150J	ELFH1315GJ	88.52
14	ELFH14110J	ELFH1411GJ	93.52	14	ELFH14150J	ELFH1415GJ	93.52
15	ELFH15110J	ELFH1511GJ	98.52	15	ELFH15150J	ELFH1515GJ	98.52
16	ELFH16110J	ELFH1611GJ	103.52	16	ELFH16150J	ELFH1615GJ	103.52
17	ELFH17110J	ELFH1711GJ	108.52	17	ELFH17150J	ELFH1715GJ	108.52
18	ELFH18110J	ELFH1811GJ	113.52	18	ELFH18150J	ELFH1815GJ	113.52
19	ELFH19110J	ELFH1911GJ	118.52	19	ELFH19150J	ELFH1915GJ	118.52
20	ELFH20110J	ELFH2011GJ	123.52	20	ELFH20150J	ELFH2015GJ	123.52
21	ELFH21110J	ELFH2111GJ	128.52	21	ELFH21150J	ELFH2115GJ	128.52
22	ELFH22110J	ELFH2211GJ	133.52	22	ELFH22150J	ELFH2215GJ	133.52

See page 25 for hi-temp, gold plating and marking options

APPROVALS:



Consult factory for specific product recognitions

SPECIFICATIONS:

Current Rating: 15A
Operating Voltage: 300V
Insulation Resistance: >10⁵ Megohms
Dielectric Withstanding: <3000V

MATERIALS:

Housing: PBT, UL 94V-0, Black or green
Contact: Copper alloy, optional finish

HEADER INSTALLATION:

Hole Diameter: .055" min.

ELFD HEADERS

2-Tier, Offset Row/Staggered Pins

5.0mm (.197")

ELFD—Horizontal



ELFD—Vertical

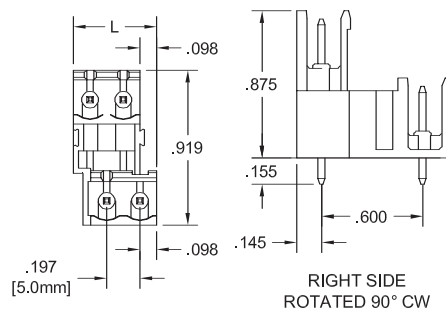

Pos	Catalog # Black	Catalog # Green	L (mm)	Pos	Catalog # Black	Catalog # Green	L (mm)
ELFD Module				ELFD Module			
4	ELFD04120	ELFD0412G	12.5	4	ELFD04160	ELFD0416G	12.5
6	ELFD06120	ELFD0612G	17.5	6	ELFD06160	ELFD0616G	17.5
ELFD Assembly				ELFD Assembly			
8	ELFD08120	ELVF0812G	22.5	8	ELFD08160	ELVF0816G	22.5
10	ELFD10120	ELVF1012G	27.5	10	ELFD10160	ELVF1016G	27.5
12	ELFD12120	ELVF1212G	32.5	12	ELFD12160	ELVF1216G	32.5
14	ELFD14120	ELVF1412G	37.5	14	ELFD14160	ELVF1416G	37.5
16	ELFD16120	ELVF1612G	42.5	16	ELFD16160	ELVF1616G	42.5
18	ELFD18120	ELVF1812G	47.5	18	ELFD18160	ELVF1816G	47.5
20	ELFD20120	ELVF2012G	52.5	20	ELFD20160	ELVF2016G	52.5
22	ELFD22120	ELVF2212G	57.5	22	ELFD22160	ELVF2216G	57.5
24	ELFD24120	ELVF2412G	62.5	24	ELFD24160	ELVF2416G	62.5
26	ELFD26120	ELVF2612G	67.5	26	ELFD26160	ELVF2616G	67.5
28	ELFD28120	ELVF2812G	72.5	28	ELFD28160	ELVF2816G	72.5
30	ELFD30120	ELVF3012G	77.5	30	ELFD30160	ELVF3016G	77.5
32	ELFD32120	ELVF3212G	82.5	32	ELFD32160	ELVF3216G	82.5
34	ELFD34120	ELVF3412G	87.5	34	ELFD34160	ELVF3416G	87.5
36	ELFD36120	ELVF3612G	92.5	36	ELFD36160	ELVF3616G	92.5
38	ELFD38120	ELVF3812G	97.5	38	ELFD38160	ELVF3816G	97.5
40	ELFD40120	ELVF4012G	102.5	40	ELFD40160	ELVF4016G	102.5
42	ELFD42120	ELVF4212G	107.5	42	ELFD42160	ELVF4216G	107.5
44	ELFD44120	ELVF4412G	112.5	44	ELFD44160	ELVF4416G	112.5
46	ELFD46120	ELVF4612G	117.5	46	ELFD46160	ELVF4616G	117.5
48	ELFD48120	ELVF4812G	122.5	48	ELFD48160	ELVF4816G	122.5

See page 25 for hi-temp, gold plating and marking options

SPECIFICATIONS:

Current Rating: 15A
Operating Voltage: 300V
Insulation Resistance: >10⁵ Megohms
Dielectric Withstanding: <3000V

MATERIALS:

Housing: PBT, UL 94V-0, Black or green
Contact: Copper alloy, optional finish

INSTALLATION:

Hole Diameter: .055" min.

2-TIER OFFSET HEADER

ELFD 2-tier headers increase board density by accepting two plugs in a vertical or horizontal, double-row configuration. Contact rows are offset to facilitate handling and wire installation. Plugs may be installed side-by-side without losing a contact position. The universal interface accepts equivalent competitive plugs.

Headers consist of 4- and 6-position dovetailed modules that may be readily interlocked to form a rigid assembly. Modules can be ordered and stacked individually, to minimize inventory, or specific sizes can be ordered pre-assembled in sizes ranging to 24 poles per row, providing a total of 48 contact positions in the 2-tier configuration.

Gold Plating: Indicate "1" as the last digit of catalog no. for black parts; "1G" in the last position for green parts.

Marking: See page 25.

Accessories: Polarizing keys and marking labels. See page 29.

APPROVALS:



Consult factory for specific product recognitions

Amphenol Pcd



2-TIER ALIGNED HEADER

ELFA 2-tier headers increase board density by accepting two plugs in a vertical or horizontal double-row configuration. In-line contact rows and end walls provide a compact, rectangular mating face, ideal for panel cut-outs and equipment I/O applications. Several plugs may be installed side-by-side in the same header without losing a contact position. The universal interface accepts equivalent competitive plugs, as well as Amphenol Pcd, to facilitate field application.

Headers are available in sizes ranging from 2 to 20 positions per row, or as many as 40 circuits total.

Standard ELFA headers are molded of high-temperature polyamide to eliminate the possibility of connector damage or deformation caused by the heat of wave soldering.

SMT Compatibility Option

ELFA headers can be supplied in an ultra-high temperature glass-filled polyamide, capable of withstanding temperatures of 260°C for three minutes and undergoing SMT reflow soldering. This eliminates the need for a separate header wave soldering operation if SMT is being employed in the board manufacturing process. Available in 4 through 24 positions only. Contact Amphenol Pcd for details.

Gold Plating: Indicate "1" as the last digit of catalog no. for black parts; "1G" in the last position for green parts.

Marking: See page 25.

Accessories: Polarizing keys and marking labels. See page 29.

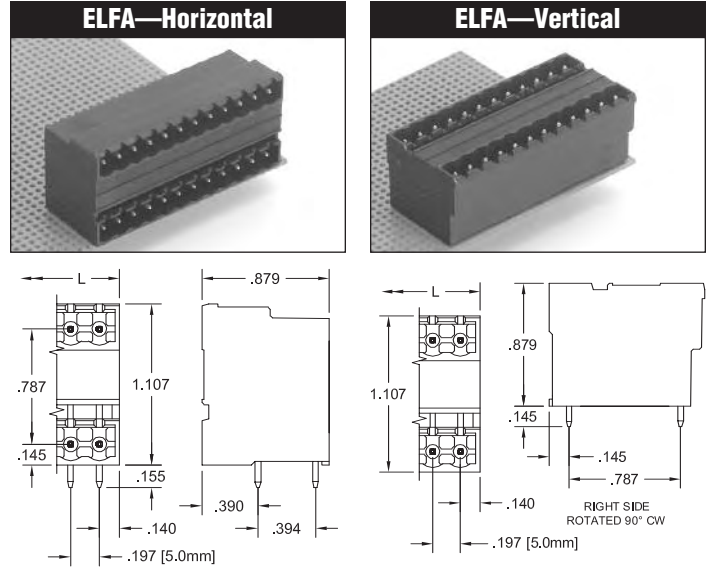

Pos	Horizontal Headers		L (mm)	Vertical Headers		L (mm)	
	Catalog # Black	Catalog # Green		Catalog # Black	Catalog # Green		
4	ELFA04110	ELFA0411G	12.0	4	ELFA04150	ELFA0415G	12.0
6	ELFA06110	ELFA0611G	17.0	6	ELFA06150	ELFA0615G	17.0
8	ELFA08110	ELFA0811G	22.0	8	ELFA08150	ELFA0815G	22.0
10	ELFA10110	ELFA1011G	27.0	10	ELFA10150	ELFA1015G	27.0
12	ELFA12110	ELFA1211G	32.0	12	ELFA12150	ELFA1215G	32.0
14	ELFA14110	ELFA1411G	37.0	14	ELFA14150	ELFA1415G	37.0
16	ELFA16110	ELFA1611G	42.0	16	ELFA16150	ELFA1615G	42.0
18	ELFA18110	ELFA1811G	47.0	18	ELFA18150	ELFA1815G	47.0
20	ELFA20110	ELFA2011G	52.0	20	ELFA20150	ELFA2015G	52.0
22	ELFA22110	ELFA2211G	57.0	22	ELFA22150	ELFA2215G	57.0
24	ELFA24110	ELFA2411G	62.0	24	ELFA24150	ELFA2415G	62.0
26	ELFA26110	ELFA2611G	67.0	26	ELFA26150	ELFA2615G	67.0
28	ELFA28110	ELFA2811G	72.0	28	ELFA28150	ELFA2815G	72.0
30	ELFA30110	ELFA3011G	77.0	30	ELFA30150	ELFA3015G	77.0
32	ELFA32110	ELFA3211G	82.0	32	ELFA32150	ELFA3215G	82.0
34	ELFA34110	ELFA3411G	87.0	34	ELFA34150	ELFA3415G	87.0
36	ELFA36110	ELFA3611G	92.0	36	ELFA36150	ELFA3615G	92.0
38	ELFA38110	ELFA3811G	97.0	38	ELFA38150	ELFA3815G	97.0
40	ELFA40110	ELFA4011G	102.0	40	ELFA40150	ELFA4015G	102.0

See page 25 for hi-temp, gold plating and marking options

APPROVALS:



Consult factory for specific product recognitions

SPECIFICATIONS:

- Current Rating:** 15A
- Operating Voltage:** 300V
- Insulation Resistance:** >10⁵ Megohms
- Dielectric Withstanding:** <3000V

MATERIALS:

- Housing:** PA 46, UL 94V-0 (Standard)
PA 66/6, UL 94V-0 (Hi-temp)
Black (Green option standard only)
- Contact:** Copper alloy, optional finish

INSTALLATION:

Hole Diameter: .055" min.

ESZ Pin-Strip Connectors Plugs and Headers

5.0mm (.197")

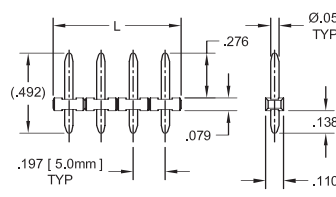
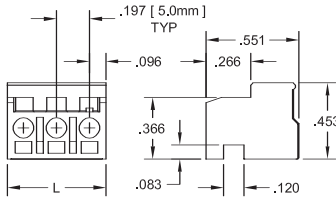
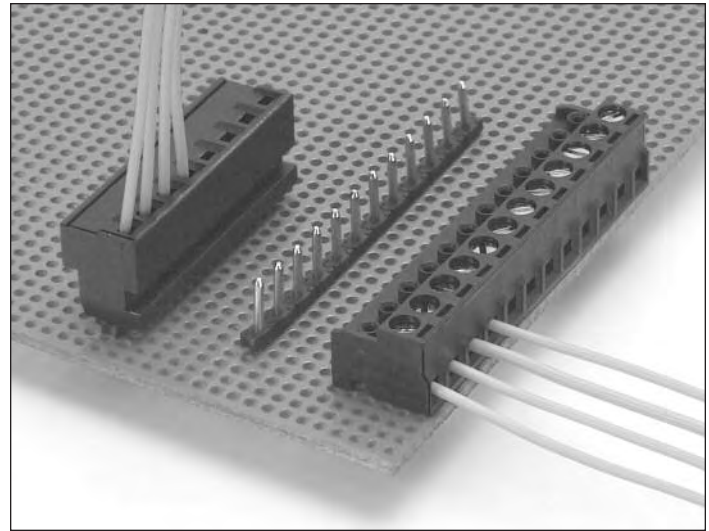
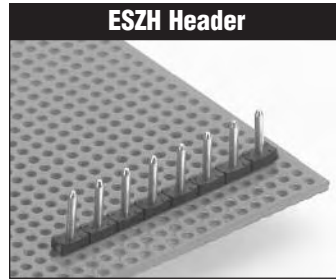

Pos	Catalog #	L (mm)	Pos	Catalog #	L (mm)
2	ESZP02100	10	2	ESZH02160	10
3	ESZP03100	15	3	ESZH03160	15
4	ESZP04100	20	4	ESZH04160	20
5	ESZP05100	25	5	ESZH05160	25
6	ESZP06100	30	6	ESZH06160	30
7	ESZP07100	35	7	ESZH07160	35
8	ESZP08100	40	8	ESZH08160	40
9	ESZP09100	45	9	ESZH09160	45
10	ESZP10100	50	10	ESZH10160	50
11	ESZP11100	55	11	ESZH11160	55
12	ESZP12100	60	12	ESZH12160	60
13	ESZP13100	65	13	ESZH13160	65
14	ESZP14100	70	14	ESZH14160	70
15	ESZP15100	75	15	ESZH15160	75
16	ESZP16100	80	16	ESZH16160	80
17	ESZP17100	85	17	ESZH17160	85
18	ESZP18100	90	18	ESZH18160	90
19	ESZP19100	95	19	ESZH19160	95
20	ESZP20100	100	20	ESZH20160	100
21	ESZP21100	105	21	ESZH21160	105
22	ESZP22100	110	22	ESZH22160	110
23	ESZP23100	115	23	ESZH23160	115
24	ESZP24100	120	24	ESZH24160	120

The ESZ style pin header and plug offer cost-oriented users a compact and economical pluggable terminal block alternate, available in 2 through 24 positions on 5.0mm spacing. Connectors are molded to length and are side-stackable on the board without loss of position. ESZH pin-strip headers may be purchased in longer strips and broken by hand to desired length. Wave-soldered to a printed board, they mate with ESZP plugs and provide an extremely low-profile interconnect in which total connection

height off the board can range from .45" to .55", depending on wire exit angle. The ESZP plug features a high reliability moving cage clamp wire termination.

Variable Wire Entry Modes

An innovative plug design permits wire entry parallel or perpendicular to the board all with the same plug, depending on how the plug is connected to the header. See schematic drawings at below.

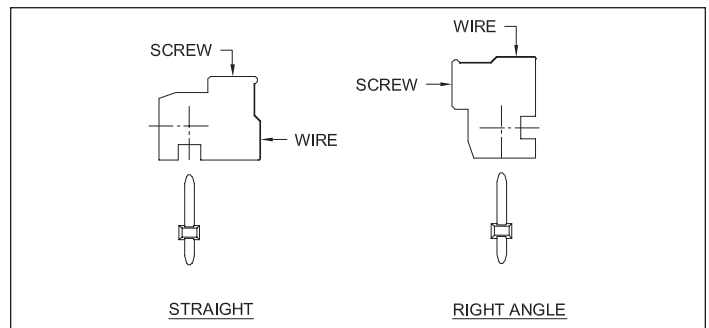

SPECIFICATIONS:

Current Rating: 12A
Operating Voltage: 300V
Insulation Resistance: >10³ Megohms

MATERIALS:

Housing (Plug/Header): Polyamide 6/6, UL 94V-0, Color: Black
Header Pin: Copper alloy, Tin-lead finish
Plug Contact: Phos bronze, Tin-lead finish
Wire Clamp: Copper Alloy, Nickel finish
Clamp Screw: Copper Alloy, Nickel finish

HEADER INSTALLATION:

Hole Diameter: .055" min.

WIRE INSTALLATION:

Strip Length: .160-.240"
Wire Range: 14-30 AWG
Recommended Tightening Torque: 4.4 lb-in. (0.5N-m)

APPROVALS:



Consult factory for specific product recognitions

Amphenol Pcd

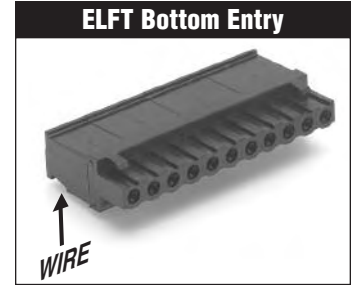
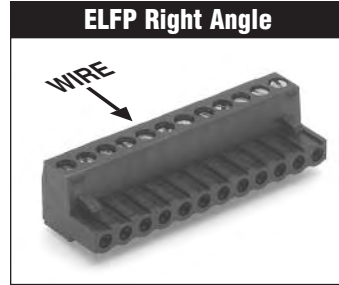

PLUGS

ELF Series plugs mate with ELF Series headers, and accommodate competitive headers as well. Precision molded housings allow wire termination while the connector is either plugged or unplugged.

ELFP blocks feature wire entry parallel to contact and mating direction.

ELFT blocks offer top or bottom wire entry perpendicular to contact and mating direction.

ELFF "front-front" blocks feature wire insertion and screw actuation from the front of the plug—plus a top or bottom wire entry option.

The 45° ELFK offers additional installation flexibility by angling both wire and screw access.

Locking Ears: See pages 36-37

Gold Plating: Indicate "1" as the last digit of catalog no. for black parts; "1G" in the last position for green parts.

Marking: See page 25

Accessories: See page 29

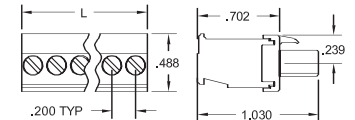
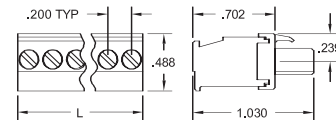
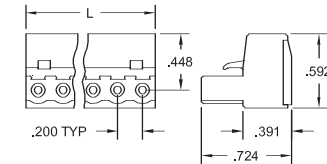

Pos	Catalog # Black	Catalog # Green	L (In.)	Pos	Catalog # Black	Catalog # Green	L (In.)	Pos	Catalog # Black	Catalog # Green	L (In.)
2	ELFP02210	ELFP0221G	0.40	2	ELFT02250	ELFT0225G	0.40	2	ELFT02260	ELFT0226G	0.40
3	ELFP03210	ELFP0321G	0.60	3	ELFT03250	ELFT0325G	0.60	3	ELFT03260	ELFT0326G	0.60
4	ELFP04210	ELFP0421G	0.80	4	ELFT04250	ELFT0425G	0.80	4	ELFT04260	ELFT0426G	0.80
5	ELFP05210	ELFP0521G	1.00	5	ELFT05250	ELFT0525G	1.00	5	ELFT05260	ELFT0526G	1.00
6	ELFP06210	ELFP0621G	1.20	6	ELFT06250	ELFT0625G	1.20	6	ELFT06260	ELFT0626G	1.20
7	ELFP07210	ELFP0721G	1.40	7	ELFT07250	ELFT0725G	1.40	7	ELFT07260	ELFT0726G	1.40
8	ELFP08210	ELFP0821G	1.60	8	ELFT08250	ELFT0825G	1.60	8	ELFT08260	ELFT0826G	1.60
9	ELFP09210	ELFP0921G	1.80	9	ELFT09250	ELFT0925G	1.80	9	ELFT09260	ELFT0926G	1.80
10	ELFP10210	ELFP1021G	2.00	10	ELFT10250	ELFT1025G	2.00	10	ELFT10260	ELFT1026G	2.00
11	ELFP11210	ELFP1121G	2.20	11	ELFT11250	ELFT1125G	2.20	11	ELFT11260	ELFT1126G	2.20
12	ELFP12210	ELFP1221G	2.40	12	ELFT12250	ELFT1225G	2.40	12	ELFT12260	ELFT1226G	2.40
13	ELFP13210	ELFP1321G	2.60	13	ELFT13250	ELFT1325G	2.60	13	ELFT13260	ELFT1326G	2.60
14	ELFP14210	ELFP1421G	2.80	14	ELFT14250	ELFT1425G	2.80	14	ELFT14260	ELFT1426G	2.80
15	ELFP15210	ELFP1521G	3.00	15	ELFT15250	ELFT1525G	3.00	15	ELFT15260	ELFT1526G	3.00
16	ELFP16210	ELFP1621G	3.20	16	ELFT16250	ELFT1625G	3.20	16	ELFT16260	ELFT1626G	3.20
17	ELFP17210	ELFP1721G	3.40	17	ELFT17250	ELFT1725G	3.40	17	ELFT17260	ELFT1726G	3.40
18	ELFP18210	ELFP1821G	3.60	18	ELFT18250	ELFT1825G	3.60	18	ELFT18260	ELFT1826G	3.60
19	ELFP19210	ELFP1921G	3.80	19	ELFT19250	ELFT1925G	3.80	19	ELFT19260	ELFT1926G	3.80
20	ELFP20210	ELFP2021G	4.00	20	ELFT20250	ELFT2025G	4.00	20	ELFT20260	ELFT2026G	4.00
21	ELFP21210	ELFP2121G	4.20	21	ELFT21250	ELFT2125G	4.20	21	ELFT21260	ELFT2126G	4.20
22	ELFP22210	ELFP2221G	4.40	22	ELFT22250	ELFT2225G	4.40	22	ELFT22260	ELFT2226G	4.40
23	ELFP23210	ELFP2321G	4.60	23	ELFT23250	ELFT2325G	4.60	23	ELFT23260	ELFT2326G	4.60
24	ELFP24210	ELFP2421G	4.80	24	ELFT24250	ELFT2425G	4.80	24	ELFT24260	ELFT2426G	4.80

See page 25 for gold plating and marking options

APPROVALS:



Consult factory for specific product recognitions

SPECIFICATIONS:

Current Rating: 15A
Operating Voltage: 300V
Insulation Resistance: >10⁵ Megohms
Dielectric Withstanding: <3000V
Wire Pullout Force:

Per UL 486E, Section 14

MATERIALS:

Housing: PPO, UL 94V-0, Black or green
Contact: Copper alloy, optional finish
Clamp Screw: Steel, nickel finish
Wire clamp: Copper alloy, nickel finish

INSTALLATION:

Wire Range: 12-26 AWG
Wire Strip Length: .310"
Recommended Tightening Torque: 7 lb-in. (0.79N-m)

ELFF/K PLUGS

Front Entry/45° Angle

.200" (5.08mm)

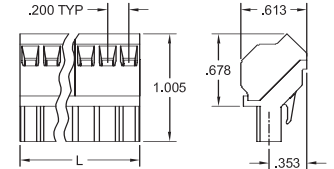
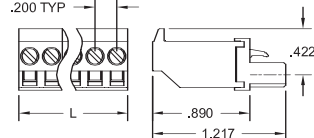

Pos	Catalog # Black	Catalog # Green	L (In.)	Pos	Catalog # Black	Catalog # Green	L (In.)	Pos	Catalog # Black	Catalog # Green	L (In.)	Pos	Catalog # Black	Catalog # Green	L (In.)
2	ELFF02230	ELFF0223G	0.40	2	ELFF02240	ELFF0224G	0.40	2	ELFF02220	ELFF0222G	0.40	2	ELFK02210	ELFK0221G	0.40
3	ELFF03230	ELFF0323G	0.60	3	ELFF03240	ELFF0324G	0.60	3	ELFF03220	ELFF0322G	0.60	3	ELFK03210	ELFK0321G	0.60
4	ELFF04230	ELFF0423G	0.80	4	ELFF04240	ELFF0424G	0.80	4	ELFF04220	ELFF0422G	0.80	4	ELFK04210	ELFK0421G	0.80
5	ELFF05230	ELFF0523G	1.00	5	ELFF05240	ELFF0524G	1.00	5	ELFF05220	ELFF0522G	1.00	5	ELFK05210	ELFK0521G	1.00
6	ELFF06230	ELFF0623G	1.20	6	ELFF06240	ELFF0624G	1.20	6	ELFF06220	ELFF0622G	1.20	6	ELFK06210	ELFK0621G	1.20
7	ELFF07230	ELFF0723G	1.40	7	ELFF07240	ELFF0724G	1.40	7	ELFF07220	ELFF0722G	1.40	7	ELFK07210	ELFK0721G	1.40
8	ELFF08230	ELFF0823G	1.60	8	ELFF08240	ELFF0824G	1.60	8	ELFF08220	ELFF0822G	1.60	8	ELFK08210	ELFK0821G	1.60
9	ELFF09230	ELFF0923G	1.80	9	ELFF09240	ELFF0924G	1.80	9	ELFF09220	ELFF0922G	1.80	9	ELFK09210	ELFK0921G	1.80
10	ELFF10230	ELFF1023G	2.00	10	ELFF10240	ELFF1024G	2.00	10	ELFF10220	ELFF1022G	2.00	10	ELFK10210	ELFK1021G	2.00
11	ELFF11230	ELFF1123G	2.20	11	ELFF11240	ELFF1124G	2.20	11	ELFF11220	ELFF1122G	2.20	11	ELFK11210	ELFK1121G	2.20
12	ELFF12230	ELFF1223G	2.40	12	ELFF12240	ELFF1224G	2.40	12	ELFF12220	ELFF1222G	2.40	12	ELFK12210	ELFK1221G	2.40
13	ELFF13230	ELFF1323G	2.60	13	ELFF13240	ELFF1324G	2.60	13	ELFF13220	ELFF1322G	2.60	13	ELFK13210	ELFK1321G	2.60
14	ELFF14230	ELFF1423G	2.80	14	ELFF14240	ELFF1424G	2.80	14	ELFF14220	ELFF1422G	2.80	14	ELFK14210	ELFK1421G	2.80
15	ELFF15230	ELFF1523G	3.00	15	ELFF15240	ELFF1524G	3.00	15	ELFF15220	ELFF1522G	3.00	15	ELFK15210	ELFK1521G	3.00
16	ELFF16230	ELFF1623G	3.20	16	ELFF16240	ELFF1624G	3.20	16	ELFF16220	ELFF1622G	3.20	16	ELFK16210	ELFK1621G	3.20
17	ELFF17230	ELFF1723G	3.40	17	ELFF17240	ELFF1724G	3.40	17	ELFF17220	ELFF1722G	3.40	17	ELFK17210	ELFK1721G	3.40
18	ELFF18230	ELFF1823G	3.60	18	ELFF18240	ELFF1824G	3.60	18	ELFF18220	ELFF1822G	3.60	18	ELFK18210	ELFK1821G	3.60
19	ELFF19230	ELFF1923G	3.80	19	ELFF19240	ELFF1924G	3.80	19	ELFF19220	ELFF1922G	3.80	19	ELFK19210	ELFK1921G	3.80
20	ELFF20230	ELFF2023G	4.00	20	ELFF20240	ELFF2024G	4.00	20	ELFF20220	ELFF2022G	4.00	20	ELFK20210	ELFK2021G	4.00
21	ELFF21230	ELFF2123G	4.20	21	ELFF21240	ELFF2124G	4.20	21	ELFF21220	ELFF2122G	4.20	21	ELFK21210	ELFK2121G	4.20
22	ELFF22230	ELFF2223G	4.40	22	ELFF22240	ELFF2224G	4.40	22	ELFF22220	ELFF2222G	4.40	22	ELFK22210	ELFK2221G	4.40
23	ELFF23230	ELFF2323G	4.60	23	ELFF23240	ELFF2324G	4.60	23	ELFF23220	ELFF2322G	4.60	23	ELFK23210	ELFK2321G	4.60
24	ELFF24230	ELFF2423G	4.80	24	ELFF24240	ELFF2424G	4.80	24	ELFF24220	ELFF2422G	4.80	24	ELFK24210	ELFK2421G	4.80

See page 25 for gold plating and marking options

SPECIFICATIONS:

Current Rating: 15A
Operating Voltage: 300V
Insulation Resistance: >10⁵ Megohms
Dielectric Withstanding: <3000V
Wire Pullout Force:
 Per UL 486E, Section 14

MATERIALS:

Housing: PPO, UL 94V-0, Black or green
Contact: Copper alloy, optional finish
Clamp Screw: Steel, nickel finish
Wire clamp: Copper alloy, nickel finish

INSTALLATION:

Wire Range: 12-26 AWG
Wire Strip Length: .310" (14-26 AWG),
 .490" (12 AWG, ELFF only)
Recommended Tightening Torque:
 7 lb-in. (0.79N-m)

APPROVALS:

Consult factory for specific product recognitions

Amphenol Pcd

.200" (5.08mm)

ELFP/T PLUGS with LOCKING EARS Right Angle/Straight



ELF SERIES PLUGS WITH LOCKING EARS

These two pages present the locking ear versions of the .200" spacing PCD plugs depicted on pages 38 and 39—an "E" is added to the catalog number (see page 25). Note: locking ears add one contact position in length to each end of the plug.

The integrally molded locking ears are available with ELFP, ELFT and ELFF plugs and all ELFH series headers. Plug ears capture a floating, slot-head locking screw that engages a threaded insert on the header ear. The mounting screw is tightened after plug and header are mated, firmly securing the connection.

Gold Plating: Contact PCD for part number guidance.

Marking: See page 25

Accessories: Polarizing keys and marking labels. See page 29..

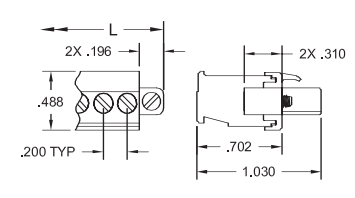
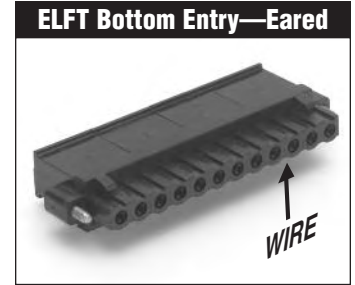
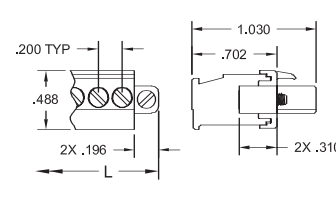
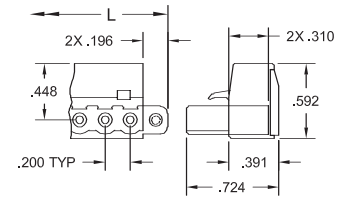

Pos	Catalog # Black	Catalog # Green	L (In.)	Pos	Catalog # Black	Catalog # Green	L (In.)	Pos	Catalog # Black	Catalog # Green	L (In.)
2	ELFP02210E	ELFP0221GE	0.80	2	ELFT02250E	ELFT0225GE	0.80	2	ELFT02260E	ELFT0226GE	0.80
3	ELFP03210E	ELFP0321GE	1.00	3	ELFT03250E	ELFT0325GE	1.00	3	ELFT03260E	ELFT0326GE	1.00
4	ELFP04210E	ELFP0421GE	1.20	4	ELFT04250E	ELFT0425GE	1.20	4	ELFT04260E	ELFT0426GE	1.20
5	ELFP05210E	ELFP0521GE	1.40	5	ELFT05250E	ELFT0525GE	1.40	5	ELFT05260E	ELFT0526GE	1.40
6	ELFP06210E	ELFP0621GE	1.60	6	ELFT06250E	ELFT0625GE	1.60	6	ELFT06260E	ELFT0626GE	1.60
7	ELFP07210E	ELFP0721GE	1.80	7	ELFT07250E	ELFT0725GE	1.80	7	ELFT07260E	ELFT0726GE	1.80
8	ELFP08210E	ELFP0821GE	2.00	8	ELFT08250E	ELFT0825GE	2.00	8	ELFT08260E	ELFT0826GE	2.00
9	ELFP09210E	ELFP0921GE	2.20	9	ELFT09250E	ELFT0925GE	2.20	9	ELFT09260E	ELFT0926GE	2.20
10	ELFP10210E	ELFP1021GE	2.40	10	ELFT10250E	ELFT1025GE	2.40	10	ELFT10260E	ELFT1026GE	2.40
11	ELFP11210E	ELFP1121GE	2.60	11	ELFT11250E	ELFT1125GE	2.60	11	ELFT11260E	ELFT1126GE	2.60
12	ELFP12210E	ELFP1221GE	2.80	12	ELFT12250E	ELFT1225GE	2.80	12	ELFT12260E	ELFT1226GE	2.80
13	ELFP13210E	ELFP1321GE	3.00	13	ELFT13250E	ELFT1325GE	3.00	13	ELFT13260E	ELFT1326GE	3.00
14	ELFP14210E	ELFP1421GE	3.20	14	ELFT14250E	ELFT1425GE	3.20	14	ELFT14260E	ELFT1426GE	3.20
15	ELFP15210E	ELFP1521GE	3.40	15	ELFT15250E	ELFT1525GE	3.40	15	ELFT15260E	ELFT1526GE	3.40
16	ELFP16210E	ELFP1621GE	3.60	16	ELFT16250E	ELFT1625GE	3.60	16	ELFT16260E	ELFT1626GE	3.60
17	ELFP17210E	ELFP1721GE	3.80	17	ELFT17250E	ELFT1725GE	3.80	17	ELFT17260E	ELFT1726GE	3.80
18	ELFP18210E	ELFP1821GE	4.00	18	ELFT18250E	ELFT1825GE	4.00	18	ELFT18260E	ELFT1826GE	4.00
19	ELFP19210E	ELFP1921GE	4.20	19	ELFT19250E	ELFT1925GE	4.20	19	ELFT19260E	ELFT1926GE	4.20
20	ELFP20210E	ELFP2021GE	4.40	20	ELFT20250E	ELFT2025GE	4.40	20	ELFT20260E	ELFT2026GE	4.40
21	ELFP21210E	ELFP2121GE	4.60	21	ELFT21250E	ELFT2125GE	4.60	21	ELFT21260E	ELFT2126GE	4.60
22	ELFP22210E	ELFP2221GE	4.80	22	ELFT22250E	ELFT2225GE	4.80	22	ELFT22260E	ELFT2226GE	4.80

See page 25 for gold plating and marking options

APPROVALS:



Consult factory for specific product recognitions

SPECIFICATIONS:

- Current Rating: 15A
- Operating Voltage: 300V
- Insulation Resistance: >10⁵ Megohms
- Dielectric Withstanding: <3000V
- Wire Pullout Force:

Per UL 486E, Section 14

MATERIALS:

- Housing: PPO, UL 94V-0, Black or green
- Contact: Copper alloy, optional finish
- Clamp Screw: Steel, nickel finish
- Wire clamp: Copper alloy, nickel finish
- Ear Screw, M2.5: Steel, nickel finish

INSTALLATION:

- Wire Range: 12-26 AWG
- Wire Strip Length: .310"
- Recommended Tightening Torque: 7 lb-in. (0.79N-m)

Amphenol Pcd

ELFF/K PLUGS with LOCKING EARS Front Entry

.200" (5.08mm)

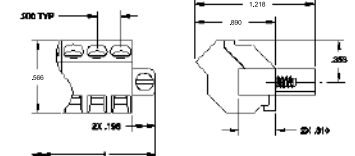

Pos	Catalog # Black	Catalog # Green	L (In.)	Pos	Catalog # Black	Catalog # Green	L (In.)	Pos	Catalog # Black	Catalog # Green	L (In.)	Pos	Catalog # Black	Catalog # Green	L (In.)
2	ELFF02230E	ELFF0223GE	0.80	2	ELFF02240	ELFF0224GE	0.80	2	ELFF02220E	ELFF0222GE	0.80	2	ELFK02210E	ELFK0221GE	0.80
3	ELFF03230E	ELFF0323GE	1.00	3	ELFF03240	ELFF0324GE	1.00	3	ELFF03220E	ELFF0322GE	1.00	3	ELFK03210E	ELFK0321GE	1.00
4	ELFF04230E	ELFF0423GE	1.20	4	ELFF04240	ELFF0424GE	1.20	4	ELFF04220E	ELFF0422GE	1.20	4	ELFK04210E	ELFK0421GE	1.20
5	ELFF05230E	ELFF0523GE	1.40	5	ELFF05240	ELFF0524GE	1.40	5	ELFF05220E	ELFF0522GE	1.40	5	ELFK05210E	ELFK0521GE	1.40
6	ELFF06230E	ELFF0623GE	1.60	6	ELFF06240	ELFF0624GE	1.60	6	ELFF06220E	ELFF0622GE	1.60	6	ELFK06210E	ELFK0621GE	1.60
7	ELFF07230E	ELFF0723GE	1.80	7	ELFF07240	ELFF0724GE	1.80	7	ELFF07220E	ELFF0722GE	1.80	7	ELFK07210E	ELFK0721GE	1.80
8	ELFF08230E	ELFF0823GE	2.00	8	ELFF08240	ELFF0824GE	2.00	8	ELFF08220E	ELFF0822GE	2.00	8	ELFK08210E	ELFK0821GE	2.00
9	ELFF09230E	ELFF0923GE	2.20	9	ELFF09240	ELFF0924GE	2.20	9	ELFF09220E	ELFF0922GE	2.20	9	ELFK09210E	ELFK0921GE	2.20
10	ELFF10230E	ELFF1023GE	2.40	10	ELFF10240	ELFF1024GE	2.40	10	ELFF10220E	ELFF1022GE	2.40	10	ELFK10210E	ELFK1021GE	2.40
11	ELFF11230E	ELFF1123GE	2.60	11	ELFF11240	ELFF1124GE	2.60	11	ELFF11220E	ELFF1122GE	2.60	11	ELFK11210E	ELFK1121GE	2.60
12	ELFF12230E	ELFF1223GE	2.80	12	ELFF12240	ELFF1224GE	2.80	12	ELFF12220E	ELFF1222GE	2.80	12	ELFK12210E	ELFK1221GE	2.80
13	ELFF13230E	ELFF1323GE	3.00	13	ELFF13240	ELFF1324GE	3.00	13	ELFF13220E	ELFF1322GE	3.00	13	ELFK13210E	ELFK1321GE	3.00
14	ELFF14230E	ELFF1423GE	3.20	14	ELFF14240	ELFF1424GE	3.20	14	ELFF14220E	ELFF1422GE	3.20	14	ELFK14210E	ELFK1421GE	3.20
15	ELFF15230E	ELFF1523GE	3.40	15	ELFF15240	ELFF1524GE	3.40	15	ELFF15220E	ELFF1522GE	3.40	15	ELFK15210E	ELFK1521GE	3.40
16	ELFF16230E	ELFF1623GE	3.60	16	ELFF16240	ELFF1624GE	3.60	16	ELFF16220E	ELFF1622GE	3.60	16	ELFK16210E	ELFK1621GE	3.60
17	ELFF17230E	ELFF1723GE	3.80	17	ELFF17240	ELFF1724GE	3.80	17	ELFF17220E	ELFF1722GE	3.80	17	ELFK17210E	ELFK1721GE	3.80
18	ELFF18230E	ELFF1823GE	4.00	18	ELFF18240	ELFF1824GE	4.00	18	ELFF18220E	ELFF1822GE	4.00	18	ELFK18210E	ELFK1821GE	4.00
19	ELFF19230E	ELFF1923GE	4.20	19	ELFF19240	ELFF1924GE	4.20	19	ELFF19220E	ELFF1922GE	4.20	19	ELFK19210E	ELFK1921GE	4.20
20	ELFF20230E	ELFF2023GE	4.40	20	ELFF20240	ELFF2024GE	4.40	20	ELFF20220E	ELFF2022GE	4.40	20	ELFK20210E	ELFK2021GE	4.40
21	ELFF21230E	ELFF2123GE	4.60	21	ELFF21240	ELFF2124GE	4.60	21	ELFF21220E	ELFF2122GE	4.60	21	ELFK21210E	ELFK2121GE	4.60
22	ELFF22230E	ELFF2223GE	4.80	22	ELFF22240	ELFF2224GE	4.80	22	ELFF22220E	ELFF2222GE	4.80	22	ELFK22210E	ELFK2221GE	4.80

See page 25 for gold plating and marking options

SPECIFICATIONS:

Current Rating: 15A
Operating Voltage: 300V
Insulation Resistance: >10⁵ Megohms
Dielectric Withstanding: <3000V
Wire Pullout Force:
 Per UL 486E, Section 14

MATERIALS:

Housing: PPO, UL 94V-0, Black or green
Contact: Copper alloy, optional finish
Clamp Screw: Steel, nickel finish
Wire clamp: Copper alloy, nickel finish
Ear Screw, M2.5: Steel, nickel finish

INSTALLATION:

Wire Range: 12-26 AWG
Wire Strip Length: .310" (14-26 AWG),
 .490" (12 AWG, ELFF only)
Recommended Tightening Torque:
 7 lb-in. (0.79N-m)

APPROVALS:

Consult factory for specific product recognitions

Amphenol Pcd

FXP FlexiPlug® HYBRID PLUGGABLE BLOCK Screw/Pressure-Plate Termination

HYBRID TERMINAL BLOCK

FXP FlexiPlug® hybrid terminal blocks combine U.S.-style standard screw-driver barrier-block wire terminations with a European-style pluggable block nose; and will mate with both Amphenol Pcd and competitive headers. FlexiPlugs can be used interchangeably with moving cage clamp style plugs, such as ELF, and both plug styles can be used in the same system.

Screw/pressure-plate terminations enclosed in a tri-barrier configuration accept either a #2 Philips head or a 1/4" flat screwdriver and will accommodate up to two 12 AWG wires or ring- or fork-tongue terminals

FLEXIPLUG OPTIONS

Optional accessories and variations, outlined below, greatly expand the FXP application range and flexibility. Refer to the Part Number Guide on this page for catalog number and ordering guidance, or contact Amphenol Pcd.

Locking Ears

Integrally molded locking ears are available with all FlexiPlugs for use in high-stress or high-vibration applications, or where unintentional disconnect must be prevented. Plug ears hold a captive floating locking screw that engages a threaded insert in the ELFH header ear.

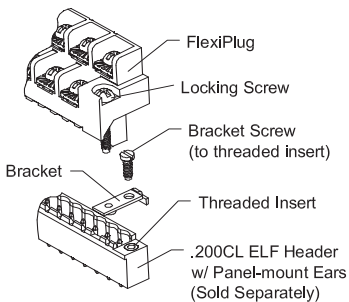

For plugs with an even number of contact positions, one locking screw must be offset from the header by using the FXPAD adapter (see illustration above).

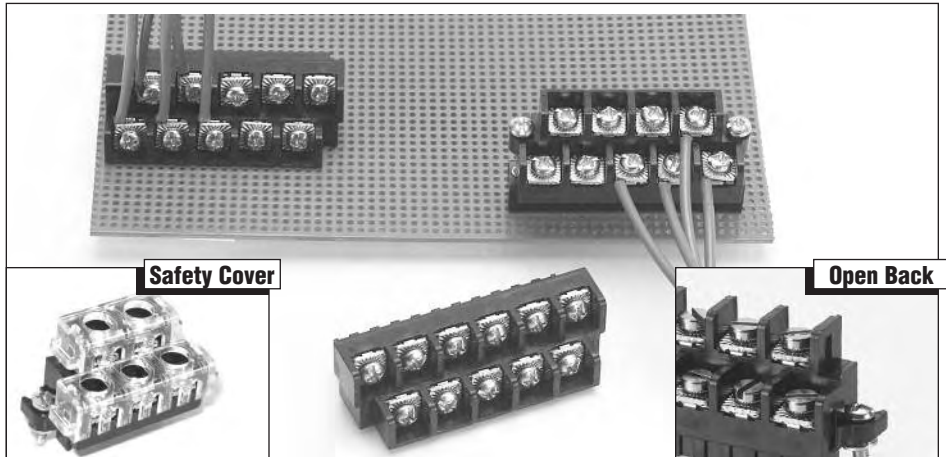

Open Back Wall

Plugs can be supplied with an open back wall on the upper row of contacts (see photo insert above). This facilitates fanning of wires in two directions during installation.

Plating

Plugs and mating ELFH headers are available with selective gold plating.

Keying

Standard ELF line keying tabs, as described on page 29, are applicable on the FXP as well.

Marking

FXP plugs are available with a variety of standard and special markings. Please contact the factory to discuss your requirements.

Color

The standard color for FXP series plugs is black. All FlexiPlugs are also available—with the same delivery commitment—in green.

Protective Cover

A clear protective "finger-proof" safety cover can be provided with the FlexiPlug. See photo above. Contact Amphenol Pcd for details.

SPECIAL VARIATIONS

In addition to the standard FlexiPlug product variations, Amphenol Pcd is a leading supplier of special block configurations and modifications, tailored to meet unusual system design requirements. The FXP screw clamp termination is suited for special I/O configurations. Please contact the factory for further discussions.

FXP PART NUMBERING GUIDE

Please consult Amphenol Pcd for availability of part no. combinations.

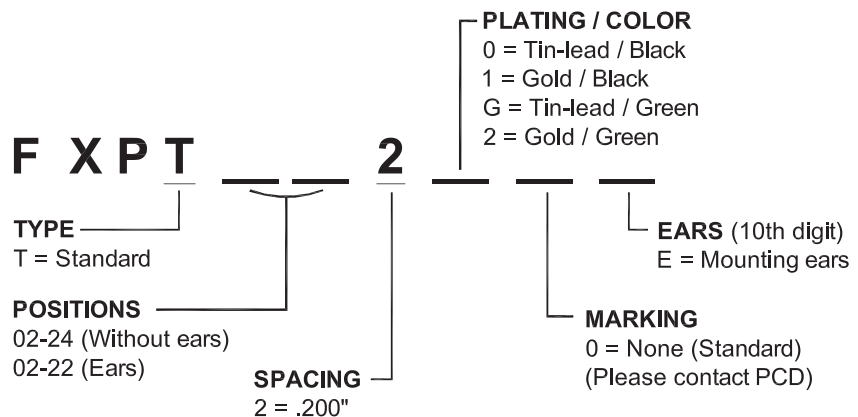

FXP FlexiPlug® HYBRID PLUGGABLE BLOCK Screw/Pressure-Plate Termination

.200" (5.08mm)

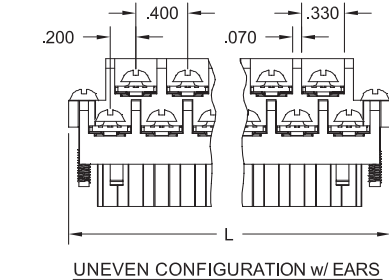
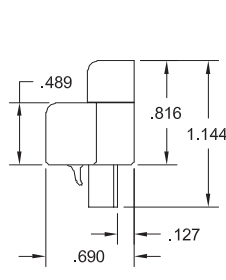
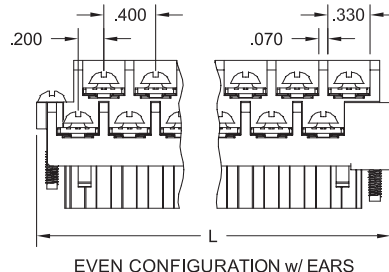
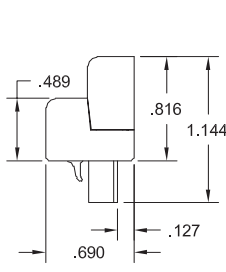

Pos	Catalog # Black	Catalog # Green	L (In.)	Pos	Catalog # Black	Catalog # Green	L (In.)	Pos	Catalog # Black	Catalog # Green	L (In.)	Pos	Catalog # Black	Catalog # Green	L (In.)
Even Configuration				Uneven Configuration				Even Configuration w/ Ears				Uneven Configuration w/ Ears			
2	FXPT02200	FXPT022G0	.670	3	FXPT03200	FXPT032G0	0.870	2	FXPT02200E	FXPT022G0E	.840	3	FXPT03200E	FXPT032G0E	1.040
4	FXPT04200	FXPT042G0	1.070	5	FXPT05200	FXPT052G0	1.270	4	FXPT04200E	FXPT042G0E	1.240	5	FXPT05200E	FXPT052G0E	1.440
6	FXPT06200	FXPT062G0	1.470	7	FXPT07200	FXPT072G0	1.670	6	FXPT06200E	FXPT062G0E	1.640	7	FXPT07200E	FXPT072G0E	1.840
8	FXPT08200	FXPT082G0	1.870	9	FXPT09200	FXPT092G0	2.070	8	FXPT08200E	FXPT082G0E	2.040	9	FXPT09200E	FXPT092G0E	2.240
10	FXPT10200	FXPT102G0	2.270	11	FXPT11200	FXPT112G0	2.470	10	FXPT10200E	FXPT102G0E	2.440	11	FXPT11200E	FXPT112G0E	2.640
12	FXPT12200	FXPT122G0	2.670	13	FXPT13200	FXPT132G0	2.870	12	FXPT12200E	FXPT122G0E	2.840	13	FXPT13200E	FXPT132G0E	3.040
14	FXPT14200	FXPT142G0	3.070	15	FXPT15200	FXPT152G0	3.270	14	FXPT14200E	FXPT142G0E	3.240	15	FXPT15200E	FXPT152G0E	3.440
16	FXPT16200	FXPT162G0	3.470	17	FXPT17200	FXPT172G0	3.670	16	FXPT16200E	FXPT162G0E	3.640	17	FXPT17200E	FXPT172G0E	3.840
18	FXPT18200	FXPT182G0	3.870	19	FXPT19200	FXPT192G0	4.070	18	FXPT18200E	FXPT182G0E	4.040	19	FXPT19200E	FXPT192G0E	4.240
20	FXPT20200	FXPT202G0	4.270	21	FXPT21200	FXPT212G0	4.470	20	FXPT20200E	FXPT202G0E	4.440	21	FXPT21200E	FXPT212G0E	4.640
22	FXPT22200	FXPT222G0	4.670	23	FXPT23200	FXPT232G0	4.870	22	FXPT22200E	FXPT222G0E	4.840				
24	FXPT24200	FXPT242G0	5.070												

SPECIFICATIONS:

Current Rating: 15A
Operating Voltage: 300V
Insulation Resistance: >10⁵ Megohms
Dielectric Withstanding: <3000V
Wire Pullout Force:
 Per UL 486E, Section 14

MATERIALS:

Housing: PPO, UL 94V-0, Black or green
Contact: Phosphor bronze, optional finish
SEM Screw: M3, Steel, nickel finish

INSTALLATION:

Wire Range: 12-26 AWG
Wire Strip Length: .250"
Recommended Tightening Torque:
 12 lb-in. (1.35N-m)
Screwdriver: #2 Phillips, 1/4" blade

APPROVALS:



Consult factory for specific product recognitions

Amphenol Pcd

ELFH HEADERS with Locking Ears



ELFH SERIES HEADERS

ELFH Series headers mate with ELF Series, FXP FlexiPlug and SCF spring clamp plugs; and accommodate competitive plugs as well. The headers are precision-molded from tough, stable PBT, providing additional strength and greater reliability under extreme conditions. Screwdriver slots at either end facilitate unplugging and eliminate the possibility of body damage.

SMT Compatibility

ELF headers are available in ultra-high-temperature, glass-filled polyamide, capable of withstanding temperatures of 260°C for three minutes while undergoing SMT reflow soldering. This eliminates the need for a separate header wave soldering operation if SMT is being employed in the board manufacturing process. See page 25 for instructions on how to order. *Note: Available in black only.*

Locking and Mounting Ears

Integrally molded locking ears are available with all ELFH headers. A threaded insert in the header ear is engaged by a plug mounting screw, which is tightened after plug and header are mated, securing the connection. *Note: locking ears add a contact position per side to header length.*

An "E" is added to the catalog number to specify locking ears.

Locking ears can also be used as mounting ears to secure the header to printed circuit boards or chassis, and are available as well with blank through-holes in the "vertical" orientation for custom mounting.

Gold Plating: Indicate "1" as the last digit of catalog no. for black parts; "1G" in the last position for green parts. *Consult PCD for assistance with locking-ear headers.*

Marking: See page 25

Accessories: Polarizing keys and marking labels. See page 29.

APPROVALS:



Contact factory for specific product recognition

Amphenol Pcd

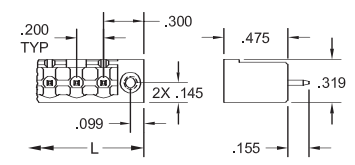
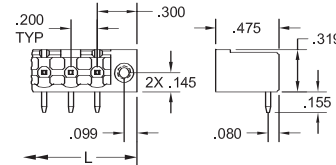

Pos	Catalog #		L (In.)	Catalog #		L (In.)	
	Black	Green		Black	Green		
2	ELFH02210E	ELFH0221GE	.80	2	ELFH02250E	ELFH0225GE	.80
3	ELFH03210E	ELFH0321GE	1.00	3	ELFH03250E	ELFH0325GE	1.00
4	ELFH04210E	ELFH0421GE	1.20	4	ELFH04250E	ELFH0425GE	1.20
5	ELFH05210E	ELFH0521GE	1.40	5	ELFH05250E	ELFH0525GE	1.40
6	ELFH06210E	ELFH0621GE	1.60	6	ELFH06250E	ELFH0625GE	1.60
7	ELFH07210E	ELFH0721GE	1.80	7	ELFH07250E	ELFH0725GE	1.80
8	ELFH08210E	ELFH0821GE	2.00	8	ELFH08250E	ELFH0825GE	2.00
9	ELFH09210E	ELFH0921GE	2.20	9	ELFH09250E	ELFH0925GE	2.20
10	ELFH10210E	ELFH1021GE	2.40	10	ELFH10250E	ELFH1025GE	2.40
11	ELFH11210E	ELFH1121GE	2.60	11	ELFH11250E	ELFH1125GE	2.60
12	ELFH12210E	ELFH1221GE	2.80	12	ELFH12250E	ELFH1225GE	2.80
13	ELFH13210E	ELFH1321GE	3.00	13	ELFH13250E	ELFH1325GE	3.00
14	ELFH14210E	ELFH1421GE	3.20	14	ELFH14250E	ELFH1425GE	3.20
15	ELFH15210E	ELFH1521GE	3.40	15	ELFH15250E	ELFH1525GE	3.40
16	ELFH16210E	ELFH1621GE	3.60	16	ELFH16250E	ELFH1625GE	3.60
17	ELFH17210E	ELFH1721GE	3.80	17	ELFH17250E	ELFH1725GE	3.80
18	ELFH18210E	ELFH1821GE	4.00	18	ELFH18250E	ELFH1825GE	4.00
19	ELFH19210E	ELFH1921GE	4.20	19	ELFH19250E	ELFH1925GE	4.20
20	ELFH20210E	ELFH2021GE	4.40	20	ELFH20250E	ELFH2025GE	4.40
21	ELFH21210E	ELFH2121GE	4.60	21	ELFH21250E	ELFH2125GE	4.60
22	ELFH22210E	ELFH2221GE	4.80	22	ELFH22250E	ELFH2225GE	4.80

See page 25 for temperature, gold plating and marking options

SPECIFICATIONS:

Current Rating: 15A
Operating Voltage: 300V
Insulation Resistance: >10⁵ Megohms
Dielectric Withstanding: <3000V

HEADER INSTALLATION:

Hole Diameter: .055" min.

MATERIALS:

Housing: PBT, UL 94V-0 (Standard)
PA 4/6, UL 94V-0 (High temp)
Black or green optional
Contact: Copper alloy, optional finish
Ear Insert, M2.5: Steel, nickel finish

ELFH HEADERS

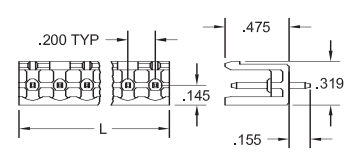
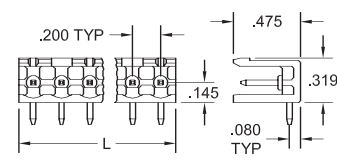
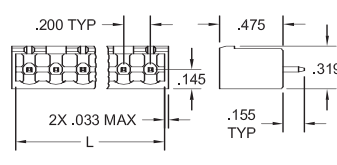
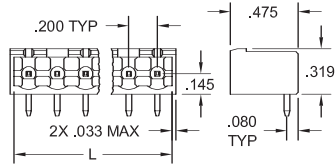

Pos	Catalog # Black	Catalog # Green	L (In.)	Pos	Catalog # Black	Catalog # Green	L (In.)	Pos	Catalog # Black	Catalog # Green	L (In.)	Pos	Catalog # Black	Catalog # Green	L (In.)
2	ELFH02210	ELFH0221G	.40	2	ELFH02250	ELFH0225G	.40	2	ELFH02220	ELFH0222G	.40	2	ELFH02260	ELFH0226G	.40
3	ELFH03210	ELFH0321G	.60	3	ELFH03250	ELFH0325G	.60	3	ELFH03220	ELFH0322G	.60	3	ELFH03260	ELFH0326G	.60
4	ELFH04210	ELFH0421G	.80	4	ELFH04250	ELFH0425G	.80	4	ELFH04220	ELFH0422G	.80	4	ELFH04260	ELFH0426G	.80
5	ELFH05210	ELFH0521G	1.00	5	ELFH05250	ELFH0525G	1.00	5	ELFH05220	ELFH0522G	1.00	5	ELFH05260	ELFH0526G	1.00
6	ELFH06210	ELFH0621G	1.20	6	ELFH06250	ELFH0625G	1.20	6	ELFH06220	ELFH0622G	1.20	6	ELFH06260	ELFH0626G	1.20
7	ELFH07210	ELFH0721G	1.40	7	ELFH07250	ELFH0725G	1.40	7	ELFH07220	ELFH0722G	1.40	7	ELFH07260	ELFH0726G	1.40
8	ELFH08210	ELFH0821G	1.60	8	ELFH08250	ELFH0825G	1.60	8	ELFH08220	ELFH0822G	1.60	8	ELFH08260	ELFH0826G	1.60
9	ELFH09210	ELFH0921G	1.80	9	ELFH09250	ELFH0925G	1.80	9	ELFH09220	ELFH0922G	1.80	9	ELFH09260	ELFH0926G	1.80
10	ELFH10210	ELFH1021G	2.00	10	ELFH10250	ELFH1025G	2.00	10	ELFH10220	ELFH1022G	2.00	10	ELFH10260	ELFH1026G	2.00
11	ELFH11210	ELFH1121G	2.20	11	ELFH11250	ELFH1125G	2.20	11	ELFH11220	ELFH1122G	2.20	11	ELFH11260	ELFH1126G	2.20
12	ELFH12210	ELFH1221G	2.40	12	ELFH12250	ELFH1225G	2.40	12	ELFH12220	ELFH1222G	2.40	12	ELFH12260	ELFH1226G	2.40
13	ELFH13210	ELFH1321G	2.60	13	ELFH13250	ELFH1325G	2.60	13	ELFH13220	ELFH1322G	2.60	13	ELFH13260	ELFH1326G	2.60
14	ELFH14210	ELFH1421G	2.80	14	ELFH14250	ELFH1425G	2.80	14	ELFH14220	ELFH1422G	2.80	14	ELFH14260	ELFH1426G	2.80
15	ELFH15210	ELFH1521G	3.00	15	ELFH15250	ELFH1525G	3.00	15	ELFH15220	ELFH1522G	3.00	15	ELFH15260	ELFH1526G	3.00
16	ELFH16210	ELFH1621G	3.20	16	ELFH16250	ELFH1625G	3.20	16	ELFH16220	ELFH1622G	3.20	16	ELFH16260	ELFH1626G	3.20
17	ELFH17210	ELFH1721G	3.40	17	ELFH17250	ELFH1725G	3.40	17	ELFH17220	ELFH1722G	3.40	17	ELFH17260	ELFH1726G	3.40
18	ELFH18210	ELFH1821G	3.60	18	ELFH18250	ELFH1825G	3.60	18	ELFH18220	ELFH1822G	3.60	18	ELFH18260	ELFH1826G	3.60
19	ELFH19210	ELFH1921G	3.80	19	ELFH19250	ELFH1925G	3.80	19	ELFH19220	ELFH1922G	3.80	19	ELFH19260	ELFH1926G	3.80
20	ELFH20210	ELFH2021G	4.00	20	ELFH20250	ELFH2025G	4.00	20	ELFH20220	ELFH2022G	4.00	20	ELFH20260	ELFH2026G	4.00
21	ELFH21210	ELFH2121G	4.20	21	ELFH21250	ELFH2125G	4.20	21	ELFH21220	ELFH2122G	4.20	21	ELFH21260	ELFH2126G	4.20
22	ELFH22210	ELFH2221G	4.40	22	ELFH22250	ELFH2225G	4.40	22	ELFH22220	ELFH2222G	4.40	22	ELFH22260	ELFH2226G	4.40
23	ELFH23210	ELFH2321G	4.60	23	ELFH23250	ELFH2325G	4.60	23	ELFH23220	ELFH2322G	4.60	23	ELFH23260	ELFH2326G	4.60
24	ELFH24210	ELFH2421G	4.80	24	ELFH24250	ELFH2425G	4.80	24	ELFH24220	ELFH2422G	4.80	24	ELFH24260	ELFH2426G	4.80

See page 25 for temperature, gold plating and marking options

MATERIALS:

Housing: PBT, UL 94V-0 (Standard)
 PA 4/6, UL 94V-0 (High temp)
 Black (Green option standard only)
Contact: Copper alloy, optional finish

SPECIFICATIONS:

Current Rating: 15A
Operating Voltage: 300V
Insulation Resistance: >10⁵ Megohms
Dielectric Withstanding: <3000V

HEADER INSTALLATION:

Hole Diameter: .055" min.

APPROVALS:



Contact factory for specific product recognition

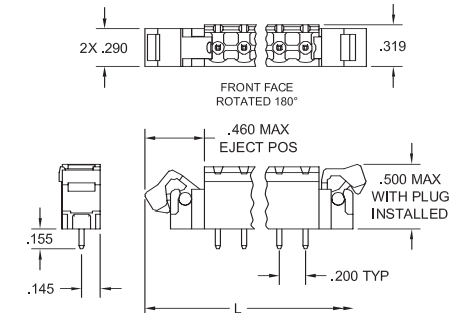
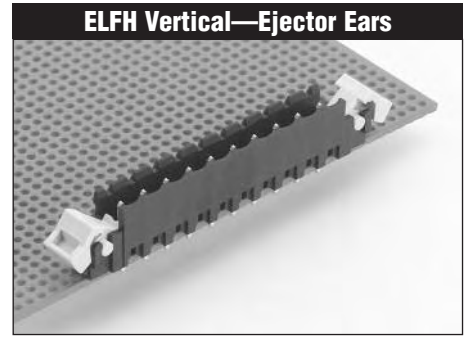

EJECTOR EAR HEADERS

The ELFH Series ejector ear header allows for plug disconnect with a minimal amount of effort by way of screwdriver or finger actuation of the levered ears.

The universal design accepts ELF Series plugs or FXP Series Flexiplug™ connectors, as well as SCF spring clamp plugs. It is currently available in 8 through 22 positions, in both .200" and 5.0mm spacing. Ejector ear headers can also be provided with the ELFH Series gold plating option.

The following options comprise the standard color combinations for ejector ear headers:

- Black header, gray ears
- Green header, black ears

Pos	Catalog # Black	Catalog # Green	L (In.)	Pos	Catalog # Black	Catalog # Green	L (In.)
8	ELFH08210J	ELFH0821GJ	2.526	8	ELFH08250J	ELFH0825GJ	2.526
9	ELFH09210J	ELFH0921GJ	2.726	9	ELFH09250J	ELFH0925GJ	2.726
10	ELFH10210J	ELFH1021GJ	2.926	10	ELFH10250J	ELFH1025GJ	2.926
11	ELFH11210J	ELFH1121GJ	3.126	11	ELFH11250J	ELFH1125GJ	3.126
12	ELFH12210J	ELFH1221GJ	3.326	12	ELFH12250J	ELFH1225GJ	3.326
13	ELFH13210J	ELFH1321GJ	3.526	13	ELFH13250J	ELFH1325GJ	3.526
14	ELFH14210J	ELFH1421GJ	3.726	14	ELFH14250J	ELFH1425GJ	3.726
15	ELFH15210J	ELFH1521GJ	3.926	15	ELFH15250J	ELFH1525GJ	3.926
16	ELFH16210J	ELFH1621GJ	4.126	16	ELFH16250J	ELFH1625GJ	4.126
17	ELFH17210J	ELFH1721GJ	4.326	17	ELFH17250J	ELFH1725GJ	4.326
18	ELFH18210J	ELFH1821GJ	4.526	18	ELFH18250J	ELFH1825GJ	4.526
19	ELFH19210J	ELFH1921GJ	4.726	19	ELFH19250J	ELFH1925GJ	4.726
20	ELFH20210J	ELFH2021GJ	4.926	20	ELFH20250J	ELFH2025GJ	4.926
21	ELFH21210J	ELFH2121GJ	5.126	21	ELFH21250J	ELFH2125GJ	5.126
22	ELFH22210J	ELFH2221GJ	5.326	22	ELFH22250J	ELFH2225GJ	5.326

See page 25 for gold plating and marking options

APPROVALS:



Contact factory for specific product recognition

SPECIFICATIONS:

Current Rating: 15A
Operating Voltage: 300V
Insulation Resistance: >10⁵ Megohms
Dielectric Withstanding: <3000V

MATERIALS:

Housing: PBT, UL 94V-0, Black or green
Contact: Copper alloy, optional finish

HEADER INSTALLATION:

Hole Diameter: .055" min.

ELFB MALE HEADERS

Board-Mount Plug, Dovetail Modular

.200" (5.08mm)

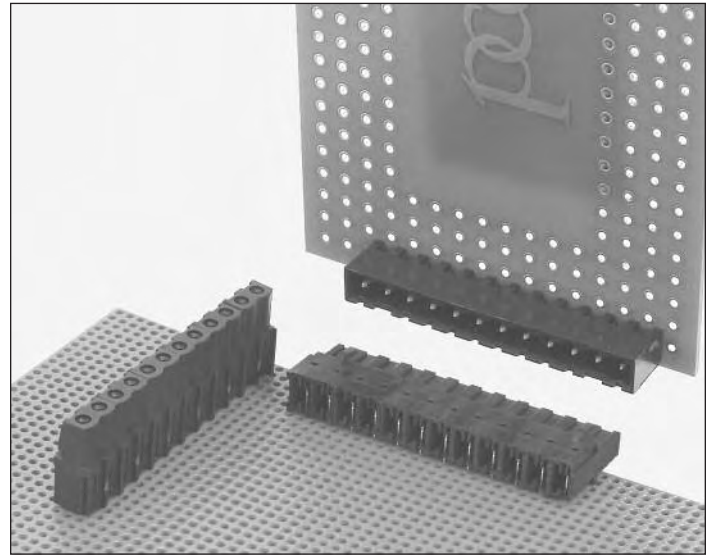

Pos	Catalog # Black	Catalog # Green	L (In.)	Pos	Catalog # Black	Catalog # Green	L (In.)
2	ELFB02230	ELFB0223G	.40	2	ELFB02280	ELFB0228G	.40
3	ELFB03230	ELFB0323G	.60	3	ELFB03280	ELFB0328G	.60
4	ELFB04230	ELFB0423G	.80	4	ELFB04280	ELFB0428G	.80
5	ELFB05230	ELFB0523G	1.00	5	ELFB05280	ELFB0528G	1.00
6	ELFB06230	ELFB0623G	1.20	6	ELFB06280	ELFB0628G	1.20
7	ELFB07230	ELFB0723G	1.40	7	ELFB07280	ELFB0728G	1.40
8	ELFB08230	ELFB0823G	1.60	8	ELFB08280	ELFB0828G	1.60
9	ELFB09230	ELFB0923G	1.80	9	ELFB09280	ELFB0928G	1.80
10	ELFB10230	ELFB1023G	2.00	10	ELFB10280	ELFB1028G	2.00
11	ELFB11230	ELFB1123G	2.20	11	ELFB11280	ELFB1128G	2.20
12	ELFB12230	ELFB1223G	2.40	12	ELFB12280	ELFB1228G	2.40
13	ELFB13230	ELFB1323G	2.60	13	ELFB13280	ELFB1328G	2.60
14	ELFB14230	ELFB1423G	2.80	14	ELFB14280	ELFB1428G	2.80
15	ELFB15230	ELFB1523G	3.00	15	ELFB15280	ELFB1528G	3.00
16	ELFB16230	ELFB1623G	3.20	16	ELFB16280	ELFB1628G	3.20
17	ELFB17230	ELFB1723G	3.40	17	ELFB17280	ELFB1728G	3.40
18	ELFB18230	ELFB1823G	3.60	18	ELFB18280	ELFB1828G	3.60
19	ELFB19230	ELFB1923G	3.80	19	ELFB19280	ELFB1928G	3.80
20	ELFB20230	ELFB2023G	4.00	20	ELFB20280	ELFB2028G	4.00

See page 25 for gold plating and marking options

MATERIALS:

Housing: Polyamide 4/6, UL 94V-0,
Black or green

Contact: Copper alloy, optional finish

INSTALLATION:

Hole Diameter: .055" min.

SPECIFICATIONS:

Current Rating: 15A

Operating Voltage: 300V

Insulation Resistance: >10⁵ Megohms

Dielectric Withstanding: <3000V

ELFB MALE (INVERTED) HEADER

Configuration

ELFB inverted headers are board-mounted solder pin headers which incorporate a mating configuration that is identical to a standard ELF family plug. The ELFB, in effect, is a board-mount plug. It features a plug-like nose and twin-beam plug contacts, and will mate with standard ELF-family pin headers, or similar competitive headers, providing board-to-board interconnect capability.

The ELFB gives system users and designers the capability to easily introduce accessory boards which can add flexibility by modifying system I/O features or adding electronics for a special application.

Headers are available in vertical and horizontal styles.

SMT Compatibility

ELFB headers are molded in an ultra-high temperature glass-filled polyamide, capable of withstanding temperatures of 260°C for three minutes and undergoing SMT reflow soldering. This eliminates the need for a separate header wave soldering operation if SMT is being employed in the board manufacturing process.

Header Options

Headers are molded to size in 2 through 20 positions, but individual headers can also be dovetailed together to form a longer assembly. Customers may order parts molded to length or, if desired, elect to minimize inventory by stocking only shorter headers—2 and 3 positions, for example—which may be assembled to any desired size.

APPROVALS:



Contact factory for specific product recognition

Amphenol Pcd



2-TIER OFFSET HEADER

ELFD 2-tier headers increase board density by accepting two plugs in a vertical or horizontal, double-row configuration. Contact rows are offset to facilitate handling and wire installation. Plugs may be installed side-by-side without losing a contact position. The universal interface accepts equivalent competitive plugs.

Headers consist of 4- and 6-position dovetailed modules that may be readily interlocked to form a rigid assembly. Modules can be ordered and stacked individually, to minimize inventory, or specific sizes can be ordered pre-assembled in sizes ranging to 24 poles per row, providing a total of 48 contact positions in the 2-tier configuration.

Gold Plating: Indicate "1" as the last digit of catalog no. for black parts; "1G" in the last position for green parts.

Marking: See page 25

Accessories: Polarizing keys and marking labels. See page 29.

ELFD—Horizontal



ELFD—Vertical



Pos	Catalog # Black	Catalog # Green	L (In.)	Pos	Catalog # Black	Catalog # Green	L (In.)
ELFD Module				ELFD Module			
4	ELFD04220	ELFD0422G	0.50	4	ELFD04260	ELFD0426G	0.50
6	ELFD06220	ELFD0622G	0.70	6	ELFD06260	ELFD0626G	0.70
ELFD Assembly				ELFD Assembly			
8	ELFD08220	ELFD0822G	0.90	8	ELFD08260	ELFD0826G	0.90
10	ELFD10220	ELFD1022G	1.10	10	ELFD10260	ELFD1026G	1.10
12	ELFD12220	ELFD1222G	1.30	12	ELFD12260	ELFD1226G	1.30
14	ELFD14220	ELFD1422G	1.50	14	ELFD14260	ELFD1426G	1.50
16	ELFD16220	ELFD1622G	1.70	16	ELFD16260	ELFD1626G	1.70
18	ELFD18220	ELFD1822G	1.90	18	ELFD18260	ELFD1826G	1.90
20	ELFD20220	ELFD2022G	2.10	20	ELFD20260	ELFD2026G	2.10
22	ELFD22220	ELFD2222G	2.30	22	ELFD22260	ELFD2226G	2.30
24	ELFD24220	ELFD2422G	2.50	24	ELFD24260	ELFD2426G	2.50
26	ELFD26220	ELFD2622G	2.70	26	ELFD26260	ELFD2626G	2.70
28	ELFD28220	ELFD2822G	2.90	28	ELFD28260	ELFD2826G	2.90
30	ELFD30220	ELFD3022G	3.10	30	ELFD30260	ELFD3026G	3.10
32	ELFD32220	ELFD3222G	3.30	32	ELFD32260	ELFD3226G	3.30
34	ELFD34220	ELFD3422G	3.50	34	ELFD34260	ELFD3426G	3.50
36	ELFD36220	ELFD3622G	3.70	36	ELFD36260	ELFD3626G	3.70
38	ELFD38220	ELFD3822G	3.90	38	ELFD38260	ELFD3826G	3.90
40	ELFD40220	ELFD4022G	4.10	40	ELFD40260	ELFD4026G	4.10
42	ELFD42220	ELFD4222G	4.30	42	ELFD42260	ELFD4226G	4.30
44	ELFD44220	ELFD4422G	4.50	44	ELFD44260	ELFD4426G	4.50
46	ELFD46220	ELFD4622G	4.70	46	ELFD46260	ELFD4626G	4.70
48	ELFD48220	ELFD4822G	4.90	48	ELFD48260	ELFD4826G	4.90

See page 25 for high-temp, gold plating and marking options

APPROVALS:



Contact factory for specific product recognition

SPECIFICATIONS:

- Current Rating:** 15A
- Operating Voltage:** 300V
- Insulation Resistance:** >10⁵ Megohms
- Dielectric Withstanding:** <3000V

MATERIALS:

- Housing:** PBT, UL 94V-0, Black or green
- Contact:** Copper alloy, optional finish

INSTALLATION:

Hole Diameter: .055" min.

ELFA HEADERS 2-Tier Aligned

.200" (5.08mm)

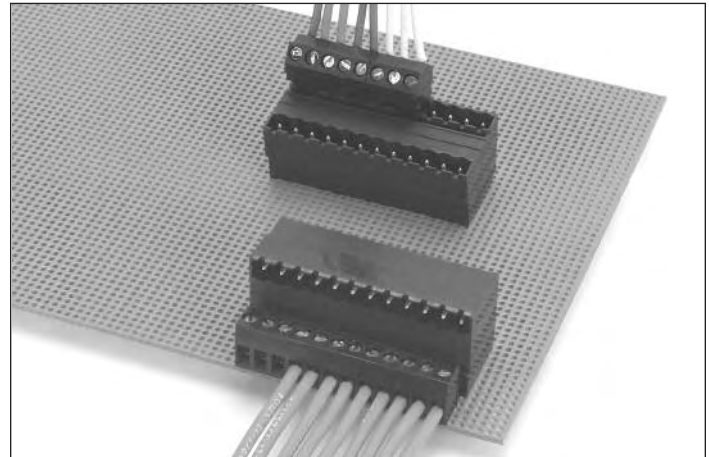
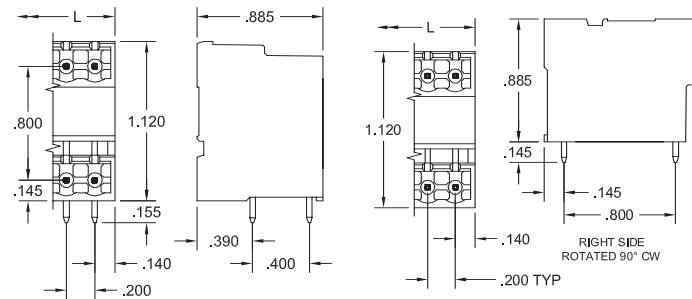

2-TIER ALIGNED HEADER

ELFA 2-tier headers increase board density by accepting two plugs in a vertical or horizontal double-row configuration. In-line contact rows and end walls provide a compact, rectangular mating face, ideal for panel cut-outs and equipment I/O applications. Several plugs may be installed side-by-side in the same header without losing a contact position. The universal interface accepts equivalent competitive plugs, as well as PCD, to facilitate field application.

Headers are available in sizes ranging from 2 to 20 positions per row, or as many as 40 circuits total.

Standard ELFA headers are molded of high-temperature polyamide to eliminate the possibility of connector damage or deformation caused by the heat of wave soldering.

SMT Compatibility

ELFA headers can be supplied in an ultra-high temperature glass-filled polyamide, capable of withstanding temperatures of 260°C for three minutes and undergoing SMT reflow soldering. This eliminates the need for a separate header wave soldering operation if SMT is being employed in the board manufacturing process. Available in 4 through 24 positions only. Contact Amphenol Pcd for details.

Gold Plating: Indicate "1" as the last digit of catalog no. for black parts; "1G" in the last position for green parts.

Marking: See page 25

Accessories: Polarizing keys and marking labels. See page 29.

Pos	Catalog # Black	Catalog # Green	L (In.)	Pos	Catalog # Black	Catalog # Green	L (In.)
Horizontal Headers				Vertical Headers			
4	ELFA04210	ELFA0421G	0.48	4	ELFA04250	ELFA0425G	0.48
6	ELFA06210	ELFA0621G	0.68	6	ELFA06250	ELFA0625G	0.68
8	ELFA08210	ELFA0821G	0.88	8	ELFA08250	ELFA0825G	0.88
10	ELFA10210	ELFA1021G	1.08	10	ELFA10250	ELFA1025G	1.08
12	ELFA12210	ELFA1221G	1.28	12	ELFA12250	ELFA1225G	1.28
14	ELFA14210	ELFA1421G	1.48	14	ELFA14250	ELFA1425G	1.48
16	ELFA16210	ELFA1621G	1.68	16	ELFA16250	ELFA1625G	1.68
18	ELFA18210	ELFA1821G	1.88	18	ELFA18250	ELFA1825G	1.88
20	ELFA20210	ELFA2021G	2.08	20	ELFA20250	ELFA2025G	2.08
22	ELFA22210	ELFA2221G	2.28	22	ELFA22250	ELFA2225G	2.28
24	ELFA24210	ELFA2421G	2.48	24	ELFA24250	ELFA2425G	2.48
26	ELFA26210	ELFA2621G	2.68	26	ELFA26250	ELFA2625G	2.68
28	ELFA28210	ELFA2821G	2.88	28	ELFA28250	ELFA2825G	2.88
30	ELFA30210	ELFA3021G	3.08	30	ELFA30250	ELFA3025G	3.08
32	ELFA32210	ELFA3221G	3.28	32	ELFA32250	ELFA3225G	3.28
34	ELFA34210	ELFA3421G	3.48	34	ELFA34250	ELFA3425G	3.48
36	ELFA36210	ELFA3621G	3.68	36	ELFA36250	ELFA3625G	3.68
38	ELFA38210	ELFA3821G	3.88	38	ELFA38250	ELFA3825G	3.88
40	ELFA40210	ELFA4021G	4.08	40	ELFA40250	ELFA4025G	4.08

See page 25 for hi-temp, gold plating and marking options

MATERIALS:

Housing: PA 46, UL 94V-0 (Standard)
PA 66/6, UL 94V-0 (Hi-temp)
Black (Green option standard only)
Contact: Copper alloy, optional finish

INSTALLATION:

Hole Diameter: .055" min.

SPECIFICATIONS:

Current Rating: 15A
Operating Voltage: 300V
Insulation Resistance: >10⁵ Megohms
Dielectric Withstanding: <3000V

APPROVALS:



Contact factory for specific product recognition

Amphenol Pcd

.300" (7.62mm)

ELFP POWER PLUGS with/without Locking Ears

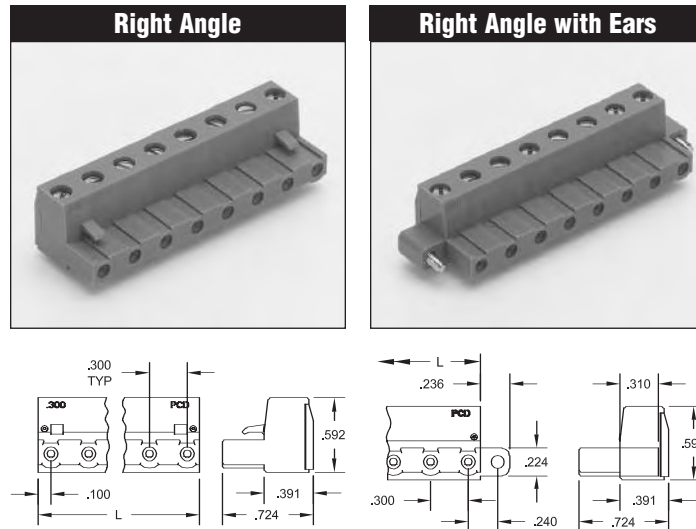
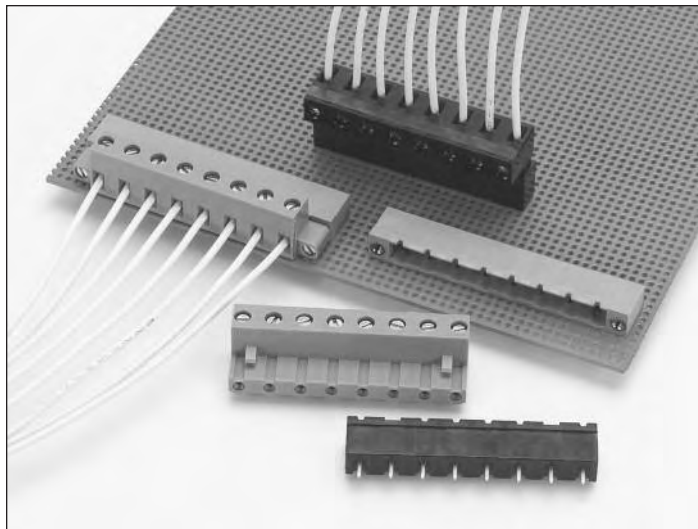

POWER BLOCKS

The .300" spacing ELFP and ELFH Power blocks and headers combine the basic design features and components of the .200"/5.0mm ELF line with larger contact spacing and a higher voltage capability. Both plugs and headers are available with or without locking ears. The wider spacing, commonly used for power I/O applications, also gives users positive discrimination for critical circuits, providing an additional level of system security.

Headers

Supplied in horizontal and vertical configurations with side walls for alignment and protection. (Headers are also available without side walls—contact Amphenol Pcd for additional information.)

Size Range

Power blocks and headers can be provided in sizes through 8 positions, and in other ELF configurations. Please contact Amphenol Pcd for configurations not indicated in the catalog.

Plugs

.300" plugs are identical to the .200"/5.0mm ELF line in all respects except center-to-center spacing and consequent voltage capability. Plugs are available in the ELFP configuration, with wire parallel to the contact and board.

Variations

The .300" product line offers the same accessories and variations as the .200"/5.0mm ELF. This includes alternate black or green colors and locking ears (catalog listed), as well as gold plating and the same keying and marking options.

Pos	Catalog #		L (In.)	Catalog #		L (In.)	
	Black	Green		Black	Green		
Right Angle			Right Angle with Ears				
2	ELFP02410	ELFP0241G	.500	2	ELFP02410E	ELFP0241GE	.972
3	ELFP03410	ELFP0341G	.700	3	ELFP03410E	ELFP0341GE	1.172
4	ELFP04410	ELFP0441G	.900	4	ELFP04410E	ELFP0441GE	1.372
5	ELFP05410	ELFP0541G	1.100	5	ELFP05410E	ELFP0541GE	1.572
6	ELFP06410	ELFP0641G	1.300	6	ELFP06410E	ELFP0641GE	1.772
7	ELFP07410	ELFP0741G	1.500	7	ELFP07410E	ELFP0741GE	1.972
8	ELFP08410	ELFP0841G	1.700	8	ELFP08410E	ELFP0841GE	2.172

See page 25 for gold plating and marking options

APPROVALS:



Contact factory for specific product recognition

SPECIFICATIONS:

Current Rating: 15A
Operating Voltage: 300V
Insulation Resistance: >10⁵ Megohms
Dielectric Withstanding: <3000V
Wire Pullout Force:
 Per UL 486E, Section 14

MATERIALS:

Housing: PPO, UL 94V-0, Black or green
Contact: Copper alloy, optional finish
Clamp Screw: Steel, nickel finish
Wire clamp: Copper alloy, nickel finish
Ear Screw, M2.5: Steel, nickel finish

INSTALLATION:

Wire Range: 12-26 AWG
Wire Strip Length: .310"
Recommended Tightening Torque:
 7 lb-in. (0.79N-m)

Amphenol Pcd

ELFT POWER PLUGS With/Without Locking Ears

.300" (7.62mm)

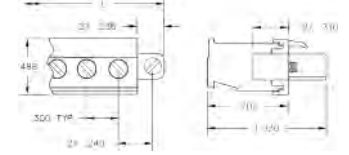
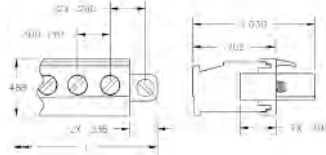
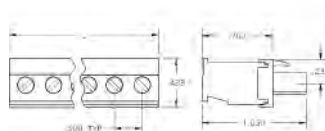
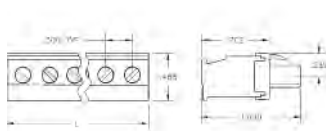

Pos	Catalog #		L (In.)	Pos	Catalog #		L (In.)	Pos	Catalog #		L (In.)	Pos	Catalog #		L (In.)
	Black	Green			Black	Green			Black	Green			Black	Green	
2	ELFT02450	ELFT0245G	.50	2	ELFT02460	ELFT0246G	.50	2	ELFT02450E	ELFT0245GE	.972	2	ELFT02460E	ELFT0246GE	.972
3	ELFT03450	ELFT0345G	.80	3	ELFT03460	ELFT0346G	.80	3	ELFT03450E	ELFT0345GE	1.172	3	ELFT03460E	ELFT0346GE	1.172
4	ELFT04450	ELFT0445G	1.10	4	ELFT04460	ELFT0446G	1.10	4	ELFT04450E	ELFT0445GE	1.372	4	ELFT04460E	ELFT0446GE	1.372
5	ELFT05450	ELFT0545G	1.40	5	ELFT05460	ELFT0546G	1.40	5	ELFT05450E	ELFT0545GE	1.572	5	ELFT05460E	ELFT0546GE	1.572
6	ELFT06450	ELFT0645G	1.70	6	ELFT06460	ELFT0646G	1.70	6	ELFT06450E	ELFT0645GE	1.772	6	ELFT06460E	ELFT0646GE	1.772
7	ELFT07450	ELFT0745G	2.00	7	ELFT07460	ELFT0746G	2.00	7	ELFT07450E	ELFT0745GE	1.972	7	ELFT07460E	ELFT0746GE	1.972
8	ELFT08450	ELFT0845G	2.30	8	ELFT08460	ELFT0846G	2.30	8	ELFT08450E	ELFT0845GE	2.172	8	ELFT08460E	ELFT0846GE	2.172

See page 25 for temperature, gold plating and marking options

SPECIFICATIONS:

Current Rating: 15A
Operating Voltage: 300V
Insulation Resistance: >10⁵ Megohms
Dielectric Withstanding: <3000V
Wire Pullout Force:
 Per UL 486E, Section 14

MATERIALS:

Housing: PPO, UL 94V-0, Black or green
Contact: Copper alloy, optional finish
Clamp Screw: Steel, nickel finish
Wire clamp: Copper alloy, nickel finish
Ear Screw, M2.5: Steel, nickel finish

INSTALLATION:

Wire Range: 12-26 AWG
Wire Strip Length: .310"
Recommended Tightening Torque:
 7 lb-in. (0.79N-m)

APPROVALS:



Contact factory for specific product recognition

Amphenol Pcd

.300" (7.62mm)

ELFH POWER HEADERS with/without Locking Ears

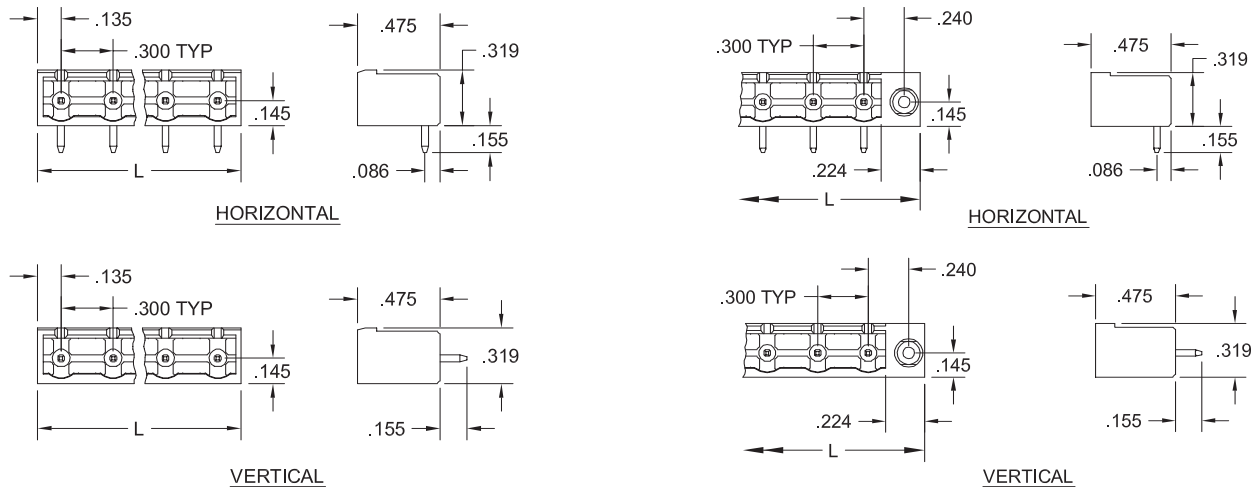
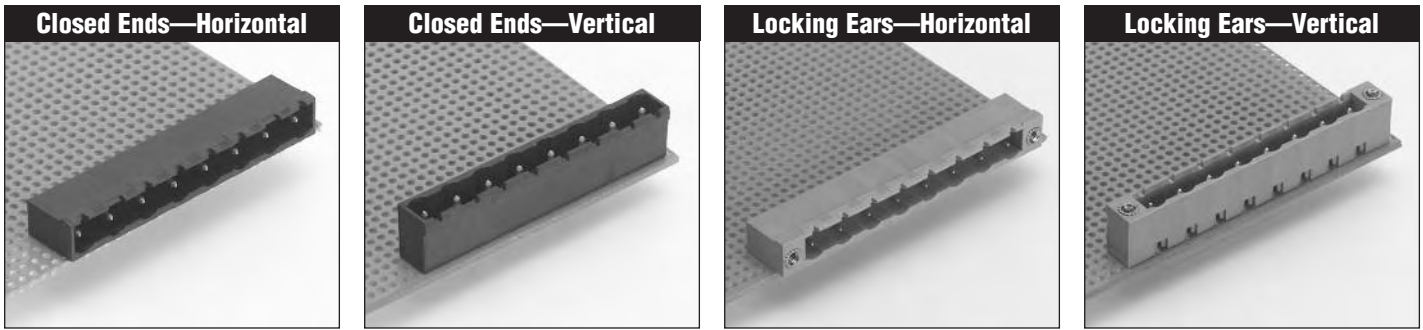

Pos	Catalog # Black	Catalog # Green	L (In.)	Pos	Catalog # Black	Catalog # Green	L (In.)	Pos	Catalog # Black	Catalog # Green	L (In.)	Pos	Catalog # Black	Catalog # Green	L (In.)
Closed Ends—Horizontal				Closed Ends—Vertical				Locking Ears—Horizontal				Locking Ears—Vertical			
2	ELFH02410	ELFH0241G	.590	2	ELFH02450	ELFH0245G	.590	2	ELFH02410E	ELFH0241GE	.974	2	ELFH02450E	ELFH0245GE	.974
3	ELFH03410	ELFH0341G	.890	3	ELFH03450	ELFH0345G	.890	3	ELFH03410E	ELFH0341GE	1.274	3	ELFH03450E	ELFH0345GE	1.274
4	ELFH04410	ELFH0441G	1.190	4	ELFH04450	ELFH0445G	1.190	4	ELFH04410E	ELFH0441GE	1.574	4	ELFH04450E	ELFH0445GE	1.574
5	ELFH05410	ELFH0541G	1.490	5	ELFH05450	ELFH0545G	1.490	5	ELFH05410E	ELFH0541GE	1.874	5	ELFH05450E	ELFH0545GE	1.874
6	ELFH06410	ELFH0641G	1.790	6	ELFH06450	ELFH0645G	1.790	6	ELFH06410E	ELFH0641GE	2.174	6	ELFH06450E	ELFH0645GE	2.174
7	ELFH07410	ELFH0741G	2.090	7	ELFH07450	ELFH0745G	2.090	7	ELFH07410E	ELFH0741GE	2.474	7	ELFH07450E	ELFH0745GE	2.474
8	ELFH08410	ELFH0841G	2.390	8	ELFH08450	ELFH0845G	2.390	8	ELFH08410E	ELFH0841GE	2.774	8	ELFH08450E	ELFH0845GE	2.774

See page 25 for temperature, gold plating and marking options

APPROVALS:



Contact factory for specific product recognition

SPECIFICATIONS:

Current Rating: 15A
Operating Voltage: 300V
Insulation Resistance: >10⁵ Megohms
Dielectric Withstanding: <3000V

MATERIALS:

Housing: PBT, UL 94V-0, Black or green
Contact: Copper alloy, optional finish
Ear Insert, M2.5: Brass, nickel finish

INSTALLATION:

Hole Diameter: .055" min.

Amphenol Pcd

ELL PLUGS & HEADERS

High Voltage 600V

.400" (10.16mm)
10.0mm (.394")

.400"/10.0MM—ELL SERIES

The .400"/10.0mm ELL product line is a double-spaced version of PCD's broad family of .200"/5.0mm ELF plugs and headers, offering a higher voltage rating—600Vrms—and the same range of configurations and accessories as the ELF line shown on pages 25 and 26.

Available Configurations

The plugs and headers available in the ELL series are listed below right. All are supplied in both .400" and 10.0mm spacing, in 2 through 12 positions. See the Part Number Guide on this page for ordering information.



SPECIFICATIONS:

Dielectric Withstanding: 3000V
Current Rating: 15A
Operating Voltage: 600V
Insulation Resistance: 10⁵ Megohms
Wire Pullout Force (Plug):
Per UL 486E, Section 14

MATERIALS:

Refer to corresponding ELF product pages.

HEADER INSTALLATION:

Hole Diameter: .055" min.

PLUG INSTALLATION

Wire Range: 12-26 AWG
Wire Strip Length: .310" (14-26 AWG),
.490" (12 AWG, ELLF only)
Recommended Tightening Torque:
7 lb-in. (0.79N-m)

APPROVALS:



ELLH Pin Headers. Vertical and horizontal orientation, closed and open sides.

ELLP Plugs. Wire entry parallel to board and contact.

ELLT Plugs. Top or bottom wire entry perpendicular to board and contact.

ELLF Plugs. Wire insertion and screw actuation from the front of the block, facilitating installation.

ELLK Plugs. 45° wire entry angle provides optimal installation and application flexibility.

Options and Variations

The same options and variations offered with the ELF are also available in the ELL line:

- High-temperature SMT Compatibility
- Choice of Black or Green
- Selective Gold Plating
- Mounting Ears
- Ejector Ear Headers
- Marking/Labels

HEADER PART NUMBERING GUIDE

Note: Not all styles and options are available with all connector types and sizes. Contact Amphenol Pcd to confirm.



.100—.375"
3.5—7.5mm

WIRE-TO-BOARD TERMINAL BLOCKS Moving Cage Clamp

Wire-to-board terminal blocks are one-piece interconnects employed to connect one or more discrete wires directly to a printed board. The blocks are soldered to the board (both through-hole and SMT technology are available) and individual wires are subsequently connected to the blocks at any point during equipment manufacturing, installation or operation, with separable screw terminations.

These blocks are broadly used in industrial and measurement/control applications where readily separable or gang interconnects are not required and emphasis is on discrete wires—but flexibility, ease of installation, reliability, ability to change connections when required, and low installation cost are all prime factors.

Different applications require very different terminal blocks. A wide range of wire-to-board blocks is available for a variety of significantly different applications, as described on pages 55–78. Important factors to consider in block choice are outlined below.

Wire Clamp Reliability

All blocks feature rising cage clamp-style wire terminations that ensure direct, high-pressure interconnection between contact and wire. The rotating screw does not contact the wire, and the contact is not bent or deformed by the screw. Potential wire strand or contact damage is eliminated, and terminal blocks will function reliably through repeated wire connections and re-connections.

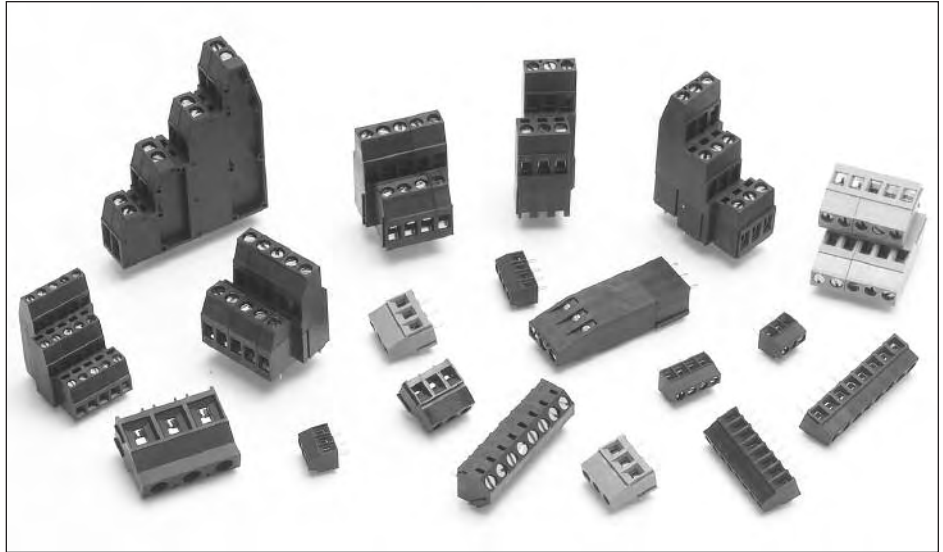
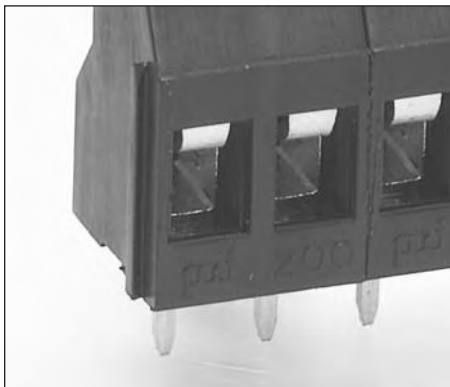

Surface Mount

The growing popularity of surface mount board components—particularly on higher density (.150" and 3.5mm) applications—has created a need for manufacturers to streamline board production by performing all component-to-board solder operations in a single high-temperature reflow solder pass that will safely and securely attach all component designs—SMT tails and through-hole solder pins—to the board. Amphenol Pcd provides two different approaches in which high density block users can utilize SMT reflow technology.

The standard .150"/3.5mm ELVM/ELXM through-hole blocks and variations shown on pages 60, 61 and 62 are molded of an ultra-high temperature polyamide, which will withstand temperatures to 260°C during the PCB production process, and is compatible with SMT reflow soldering as well as wave soldering processes.

Page 56 depicts the .150"/3.5mm SMV/X true SMT blocks which combine a rising cage clamp with "L" style SMT leads.

Modularity

Many of the blocks on pages 55–78 can be provided in 2- and 3-position modules that dovetail together to form any desired length. Users have the

option to order the modules and assemble-to-length themselves, minimizing inventory, or to specify blocks to be supplied to specific length. Where a modular option exists it is noted on the catalog page.

Variations

Blocks are available in vertical, horizontal and angled wire-entry configurations; and are supplied in a range of sizes, spacings, current ratings and wire-size accommodations. Black is the standard color, but many are also available in green. Specifications are provided on each page.

Special hold-down mounting ears for critical applications, as well as marking to customer requirement and other application-specific block modifications are also available. Contact Amphenol Pcd to discuss your requirements.

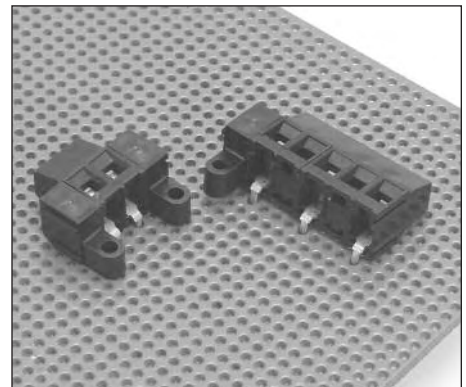

Amphenol Pcd

ESDM Ultra-Miniature Terminal Block

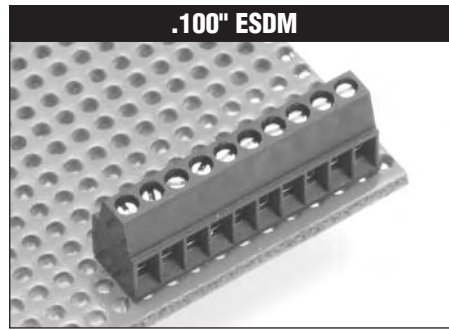

Highest Density

The .100" spacing ultra-high density and ultra-miniature ESDM terminal block, with a board footprint only .256" wide, offers the highest wire-to-board screw termination density available.

Moving Cage Clamp

Blocks feature moving cage clamp screw termination and are available in 2 through 12 positions, molded to size. Blocks are not side stackable.

Available in black only.

Pos	Catalog #	L (In.)
2	ESDM02100	.218
3	ESDM03100	.318
4	ESDM04100	.418
5	ESDM05100	.518
6	ESDM06100	.618
7	ESDM07100	.718
8	ESDM08100	.818
9	ESDM09100	.908
10	ESDM10100	1.018
11	ESDM11100	1.118
12	ESDM12100	1.218

INSTALLATION:

Wire Range: 16-30 AWG
Wire Strip Length: .160-.200"
Recommended Tightening Torque:
 1.15 lb-in. (0.13N-m)
Hole Diameter: .043" min.

MATERIALS:

Housing: Polyamide 6/6, UL 94V-0, black
Contact: Copper alloy, tin-lead finish
Clamp Screw: Copper alloy, nickel finish
Wire clamp: Copper alloy, nickel finish

SPECIFICATIONS:

Current Rating: 10A
Operating Voltage: 150V
Insulation Resistance: >10³ Megohms

APPROVALS:



Consult factory for specific product recognitions

Amphenol Pcd

.150" (3.81mm)
5.0mm (.138")

SMVM/SMXM High-Density Blocks Surface Mount, Screw Retention

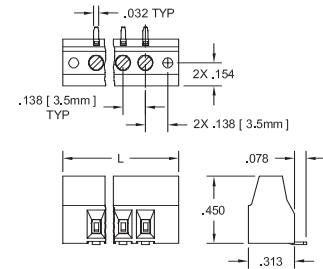
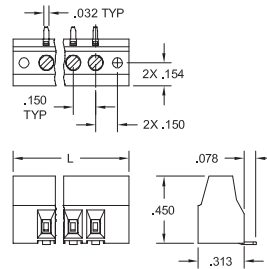
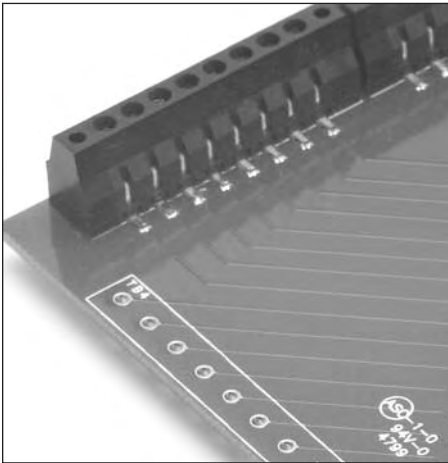

True Surface-Mount

True surface-mount terminal blocks facilitate board assembly. Tin-lead plated solder contact tabs are specifically designed for compatibility with SMT reflow solder installation.

Fastening Options

SMT terminal blocks must be securely and independently fastened to the board in order to isolate the solder contacts from stresses created by wire-to-board termination. Amphenol Pcd SMV/SMX blocks are supplied with screw fasteners that provide a rigid tie-down mechanical link between connector and board, eliminating stress transfer. (See illustration, this page.)

Other Options

Please contact Amphenol Pcd regarding through-hole pin mounting, custom colors and marking, selective contact loading and tube packaging.

Pos	Catalog # Black	Catalog # Green	L (In.)	Pos	Catalog # Black	Catalog # Green	L (mm)
2	SMVM02101	SMVM021G0	.60	2	SMXM02101	SMXM021G0	14.0
3	SMVM03101	SMVM031G0	.75	3	SMXM03101	SMXM031G0	17.5
4	SMVM04101	SMVM041G0	.90	4	SMXM04101	SMXM041G0	21.0
5	SMVM05101	SMVM051G0	1.05	5	SMXM05101	SMXM051G0	24.5
6	SMVM06101	SMVM061G0	1.20	6	SMXM06101	SMXM061G0	28.0
7	SMVM07101	SMVM071G0	1.35	7	SMXM07101	SMXM071G0	31.5
8	SMVM08101	SMVM081G0	1.50	8	SMXM08101	SMXM081G0	35.0
9	SMVM09101	SMVM091G0	1.65	9	SMXM09101	SMXM091G0	38.5
10	SMVM10101	SMVM101G0	1.80	10	SMXM10101	SMXM101G0	42.0

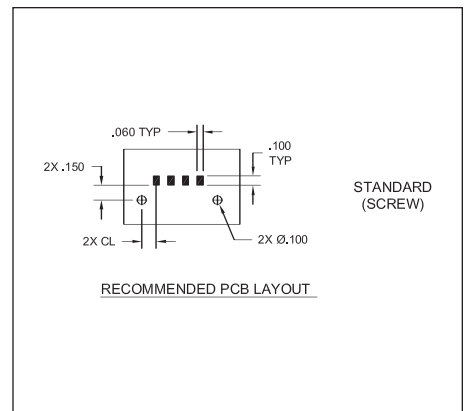
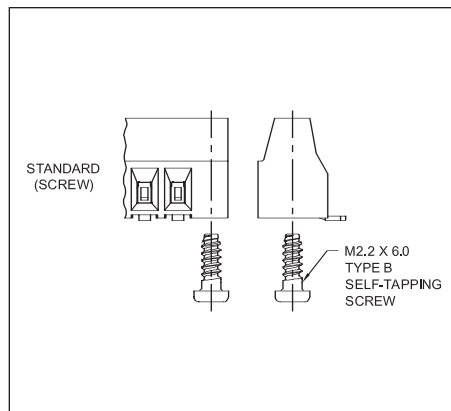

APPROVALS:



Consult factory for specific product recognitions

SPECIFICATIONS:

Current Rating: 12A
Operating Voltage: 300V
Insulation Resistance: >10³ Megohms
Dielectric Withstanding: <1600V
Wire Pullout Force:
 Per UL 486E, Section 14

MATERIALS:

Housing: Polyamide 4/6, UL 94V-0, black or green
Contact: Brass, tin-lead finish
Wire Clamp/Screw: Copper alloy, nickel finish

INSTALLATION:

Wire Range: 16-28 AWG
Wire Strip Length: .250"
Recommended Tightening Torque: 2.2 lb-in. (0.25N-m)

Amphenol Pcd

SMVM/SMXM High-Density Blocks Surface Mount, Solder Retention

.150" (3.81mm)
5.0mm (.138")

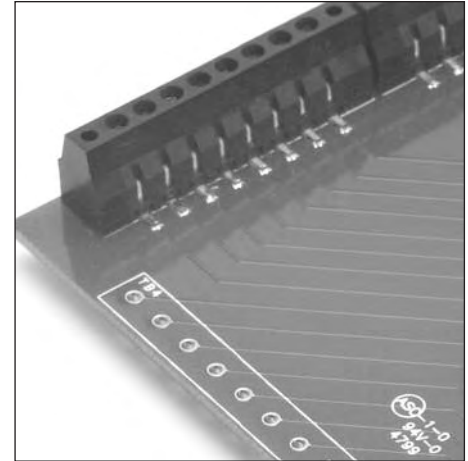

Pos	Catalog # Black	Catalog # Green	L (In.)	Pos	Catalog # Black	Catalog # Green	L (mm)
2	SMVM02101	SMVM021G0	.60	2	SMXM02101	SMXM021G0	14.0
3	SMVM03101	SMVM031G0	.75	3	SMXM03101	SMXM031G0	17.5
4	SMVM04101	SMVM041G0	.90	4	SMXM04101	SMXM041G0	21.0
5	SMVM05101	SMVM051G0	1.05	5	SMXM05101	SMXM051G0	24.5
6	SMVM06101	SMVM061G0	1.20	6	SMXM06101	SMXM061G0	28.0
7	SMVM07101	SMVM071G0	1.35	7	SMXM07101	SMXM071G0	31.5
8	SMVM08101	SMVM081G0	1.50	8	SMXM08101	SMXM081G0	35.0
9	SMVM09101	SMVM091G0	1.65	9	SMXM09101	SMXM091G0	38.5
10	SMVM10101	SMVM101G0	1.80	10	SMXM10101	SMXM101G0	42.0

True Surface-Mount

True surface-mount terminal blocks facilitate board assembly. Tin-lead plated solder contact tabs are specifically designed for compatibility with SMT reflow solder installation.

Fastening Options

SMT terminal blocks must be securely and independently fastened to the board in order to isolate the solder contacts from stresses created by wire-to-board termination. Additional heavy-duty solder mounting pads on the block facilitate automated PWB board pick-and-place assembly. Blocks may be provided with tape-and-reel packaging. Contact Amphenol Pcd for details.

Other Options

Please contact Amphenol Pcd regarding through-hole pin mounting, custom colors and marking, selective contact loading and tube packaging.

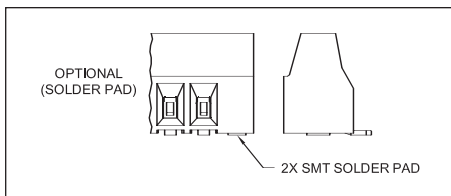

Tape-and-reel packaging available

MATERIALS:

Housing: Polyamide 4/6, UL 94V-0, black or green
Contact: Brass, tin-lead finish
Wire Clamp/Screw: Copper alloy, nickel finish

INSTALLATION:

Wire Range: 16-28 AWG
Wire Strip Length: .250"
Recommended Tightening Torque: 2.2 lb-in. (0.25N-m)

SPECIFICATIONS:

Current Rating: 12A
Operating Voltage: 300V
Insulation Resistance: >10³ Megohms
Dielectric Withstanding: <1600V
Wire Pullout Force:
Per UL 486E, Section 14

APPROVALS:



Consult factory for specific product recognitions

Amphenol Pcd

.150" (3.81mm)
3.5mm (.138")

ESBM Low-Profile Terminal Block

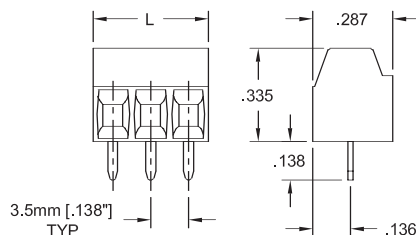
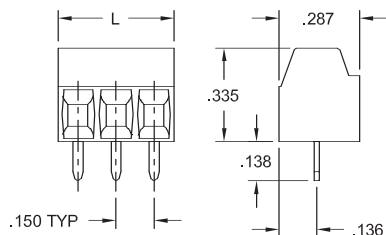
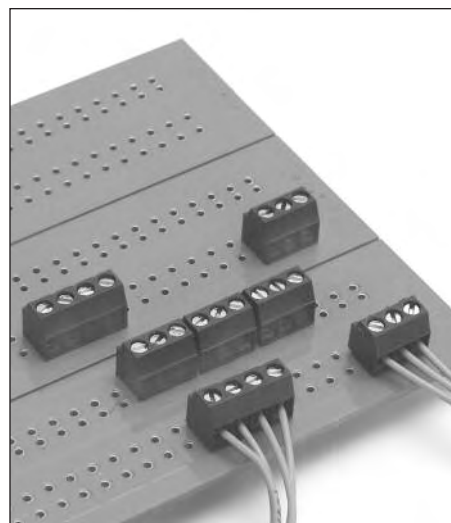
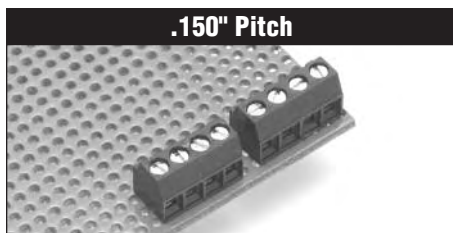

Pos	Catalog #	L (in.)	Pos	Catalog #	L (mm)
2	ESBM02200	0.300	2	ESBM02100	7.0
3	ESBM03200	0.450	3	ESBM03100	10.5
4	ESBM04200	0.600	4	ESBM04100	14.0
5	ESBM05200	0.750	5	ESBM05100	17.5
6	ESBM06200	0.900	6	ESBM06100	21.0
7	ESBM07200	1.050	7	ESBM07100	24.5
8	ESBM08200	1.200	8	ESBM08100	28.0
9	ESBM09200	1.350	9	ESBM09100	31.5
10	ESBM10200	1.500	10	ESBM10100	35.0
11	ESBM11200	1.650	11	ESBM11100	38.5
12	ESBM12200	1.800	12	ESBM12100	42.0
13	ESBM13200	1.950	13	ESBM13100	45.5
14	ESBM14200	2.100	14	ESBM14100	49.0
15	ESBM15200	2.250	15	ESBM15100	52.5
16	ESBM16200	2.400	16	ESBM16100	56.0
17	ESBM17200	2.550	17	ESBM17100	59.5
18	ESBM18200	2.700	18	ESBM18100	63.0
19	ESBM19200	2.850	19	ESBM19100	66.5
20	ESBM20200	3.000	20	ESBM20100	70.0
21	ESBM21200	3.150	21	ESBM21100	73.5
22	ESBM22200	3.300	22	ESBM22100	77.0
23	ESBM23200	3.450	23	ESBM23100	80.5
24	ESBM24200	3.600	24	ESBM24100	84.0

Lowest Height-off-Board

The .150"/3.5mm-pitch ESB line offers the lowest height off the board—.335"/8.5mm—of any screw terminal block in any spacing. This minimal profile can be of critical importance in tight packaging configurations.

Moving Cage Clamp

Blocks feature moving cage clamp screw termination, are available in 2 through 24 positions, molded to size, and can be installed end-to-end on the board without losing a contact position. This end-to-end capability allows users with diversified requirements to stock only a few basic block sizes, and assemble on the board to any block length desired.

Available in black only.

APPROVALS:



Consult factory for specific product recognitions

MATERIALS:

Housing: Polyamide 6/6, UL 94V-0, black
Contact: Copper alloy, tin-lead finish
Clamp Screw: Copper alloy, nickel finish
Wire clamp: Copper alloy, nickel finish

SPECIFICATIONS:

Current Rating: 12A
Operating Voltage: 150V
Insulation Resistance: >10³ Megohms

INSTALLATION:

Wire Range: 16-28 AWG
Wire Strip Length: .197"
Recommended Tightening Torque: 2.2 lb-in. (0.25N-m)
Hole Diameter: .043" min.

Amphenol Pcd

EL3V 3-Tier, High-Density Terminal Block

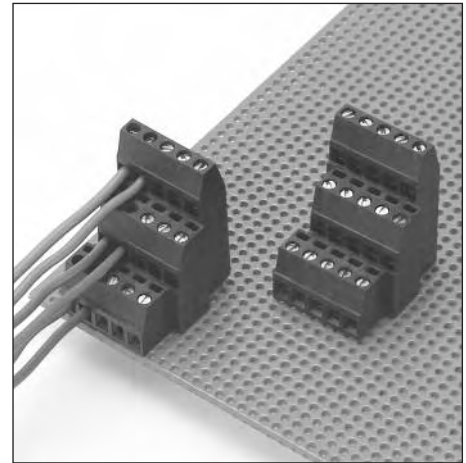

High-density, 3-tier version of the .150" ELV terminal block shown on page 60. Molded to size in 3-tier configurations ranging from a total of 6 to 30 contacts. Blocks can be stacked adjacent to each other on a board without the loss of a position.

Moving cage clamp wire terminations ensure reliability and repeated reusability.

Options and Variations

Available in black or green. Please contact Amphenol Pcd regarding marking and custom configuration.

Pos	Catalog # Black	Catalog # Green	L (In.)
6	EL3V061B00	EL3V061G00	.375
9	EL3V091B00	EL3V091G00	.525
12	EL3V121B00	EL3V121G00	.675
15	EL3V151B00	EL3V151G00	.825
18	EL3V181B00	EL3V181G00	.975
21	EL3V211B00	EL3V211G00	1.125
24	EL3V241B00	EL3V241G00	1.275
27	EL3V271B00	EL3V271G00	1.425
30	EL3V301B00	EL3V301G00	1.575

MATERIALS:

- Housing:** Polyamide 4/6, UL 94V-0, black or green
- Contact:** Brass, tin-lead finish
- Wire Clamp/Screw:** Copper alloy, nickel finish

INSTALLATION:

- Wire Range:** 16-28 AWG
- Wire Strip Length:** .250"
- Recommended Tightening Torque:** 2.2 lb-in. (0.25N-m)
- Hole Diameter:** .047 min.

SPECIFICATIONS:

- Current Rating:** 12A
- Operating Voltage:** 300V
- Insulation Resistance:** >10³ Megohms
- Dielectric Withstanding:** <1600V
- Wire Pullout Force:**
Per UL 486E, Section 14

APPROVALS:



Consult factory for specific product recognitions

.150" (3.81mm)

ELVM Fixed Terminal Blocks SMT Compatible

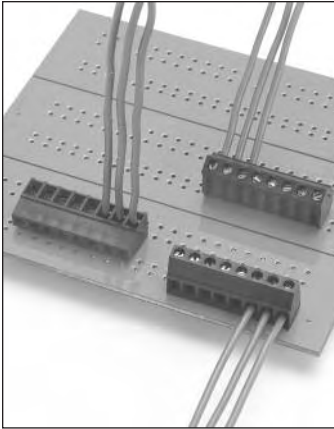

ELVM .150" spacing wire-to-board terminal blocks are available in vertical, horizontal and angled wire entry variations.

SMT Compatibility

The ELVM is suitable for SMT reflow solder PCB manufacturing processes as well as wave solder, providing users with additional flexibility and maximizing production efficiencies by eliminating secondary solder operations. Terminal blocks are molded of ultra-high-temperature, glass-filled polyamide that will withstand temperatures of 260°C during PCB production.

Moving cage clamp wire termination assures repeated, high-reliability connections. The housing is molded to size. Blocks are available in sizes 2 to 10, and can be stacked side-to-side on a board without loss of a contact position.



Pos	Catalog #		L (In.)	Pos	Catalog #		L (In.)	Pos	Catalog #		L (In.)
	Black	Green			Black	Green			Black	Green	
2	ELVM02100	ELVM021G0	.30	2	ELVM02300	ELVM023G0	.30	2	ELVM02900	ELVM029G0	.30
3	ELVM03100	ELVM031G0	.45	3	ELVM03300	ELVM033G0	.45	3	ELVM03900	ELVM039G0	.45
4	ELVM04100	ELVM041G0	.60	4	ELVM04300	ELVM043G0	.60	4	ELVM04900	ELVM049G0	.60
5	ELVM05100	ELVM051G0	.75	5	ELVM05300	ELVM053G0	.75	5	ELVM05900	ELVM059G0	.75
6	ELVM06100	ELVM061G0	.90	6	ELVM06300	ELVM063G0	.90	6	ELVM06900	ELVM069G0	.90
7	ELVM07100	ELVM071G0	1.05	7	ELVM07300	ELVM073G0	1.05	7	ELVM07900	ELVM079G0	1.05
8	ELVM08100	ELVM081G0	1.20	8	ELVM08300	ELVM083G0	1.20	8	ELVM08900	ELVM089G0	1.20
9	ELVM09100	ELVM091G0	1.35	9	ELVM09300	ELVM093G0	1.35	9	ELVM09900	ELVM099G0	1.35
10	ELVM10100	ELVM101G0	1.50	10	ELVM10300	ELVM103G0	1.50	10	ELVM10900	ELVM109G0	1.50

APPROVALS:



Consult factory for specific product recognitions

SPECIFICATIONS:

Current Rating: 12A
Operating Voltage: 300V
Insulation Resistance: >10⁵ Megohms
Dielectric Withstanding: <3000V
Wire Pullout Force:

Per UL 486E, Section 14

MATERIALS:

Housing: Polyamide 4/6, UL 94V-0, black or green
Contact: Brass, optional finish
Clamp Screw: Copper alloy, nickel finish
Wire Clamp: Copper alloy, nickel finish

INSTALLATION:

Wire Range: 16-28 AWG
Wire Strip Length: .250"
Recommended Tightening Torque: 2.2 lb-in. (0.25N-m)
Hole Diameter: .047 min.

Amphenol Pcd

ELXM Fixed Terminal Blocks SMT Compatible

3.5mm (.138")



ELXM 3.5mm spacing wire-to-board terminal blocks are available in vertical, horizontal and angled wire entry variations.

SMT Compatibility

The ELXM is suitable for SMT reflow solder PCB manufacturing processes as well as wave solder, providing users with additional flexibility and maximizing production efficiencies by eliminating secondary solder operations. Terminal blocks are molded of ultra-high-temperature, glass-filled polyamide that will withstand temperatures of 260°C during PCB production.

Moving cage clamp wire termination assures repeated, high-reliability connections. The housing is molded to size. Blocks are available in sizes 2 to 10, and can be stacked side-to-side on a board without loss of a contact position.

Pos	Catalog # Black	Catalog # Green	L (In.)	Pos	Catalog # Black	Catalog # Green	L (In.)	Pos	Catalog # Black	Catalog # Green	L (In.)
2	ELXM02100	ELXM021G0	7.0	2	ELXM02300	ELXM023G0	7.0	2	ELXM02900	ELXM029G0	7.0
3	ELXM03100	ELXM031G0	10.5	3	ELXM03300	ELXM033G0	10.5	3	ELXM03900	ELXM039G0	10.5
4	ELXM04100	ELXM041G0	14.0	4	ELXM04300	ELXM043G0	14.0	4	ELXM04900	ELXM049G0	14.0
5	ELXM05100	ELXM051G0	17.5	5	ELXM05300	ELXM053G0	17.5	5	ELXM05900	ELXM059G0	17.5
6	ELXM06100	ELXM061G0	21.0	6	ELXM06300	ELXM063G0	21.0	6	ELXM06900	ELXM069G0	21.0
7	ELXM07100	ELXM071G0	24.5	7	ELXM07300	ELXM073G0	24.5	7	ELXM07900	ELXM079G0	24.5
8	ELXM08100	ELXM081G0	28.0	8	ELXM08300	ELXM083G0	28.0	8	ELXM08900	ELXM089G0	28.0
9	ELXM09100	ELXM091G0	31.5	9	ELXM09300	ELXM093G0	31.5	9	ELXM09900	ELXM099G0	31.5
10	ELXM10100	ELXM101G0	35.0	10	ELXM10300	ELXM103G0	35.0	10	ELXM10900	ELXM109G0	35.0

INSTALLATION:

Wire Range: 16-28 AWG
Wire Strip Length: .250"
Recommended Tightening Torque:
 2.2 lb-in. (0.25N-m)
Hole Diameter: .047 min.

MATERIALS:

Housing: Polyamide 4/6, UL 94V-0, black or green
Contact: Brass, optional finish
Clamp Screw: Copper alloy, nickel finish
Wire Clamp: Copper alloy, nickel finish

SPECIFICATIONS:

Current Rating: 12A
Operating Voltage: 300V
Insulation Resistance: >10⁵ Megohms
Dielectric Withstanding: <3000V
Wire Pullout Force:
 Per UL 486E, Section 14

APPROVALS:

Consult factory for specific product recognitions

Amphenol Pcd

.200" (5.08mm)

ELM Fixed Terminal Blocks Modular, Assembled-to-Size



ELM .200" spacing wire-to-board moving cage clamp terminal blocks are available in vertical, horizontal and angled wire entry variations.

Interlocking Modules

The ELM family consists of precision molded 2- and 3-position screw termination modules with interlocking dovetails. Modules can be joined without loss of pin spacing, giving users the option of purchasing and stocking only the 2- and 3-position modules—and assembling to size in-house—in order to minimize inventory and maintain flexibility; or ordering product already assembled to size.

Options and Variations

ELM terminations are available in black or green.

Contact Amphenol Pcd for information on marking, hold-down mounting ears and other application-specific variations.



Pos	Catalog #		L (In.)	Pos	Catalog #		L (In.)	Pos	Catalog #		L (In.)
	Black	Green			Black	Green			Black	Green	
ELM Modules				ELM Modules				ELM Modules			
2	ELM021200	ELM02120G	.40	2	ELM023200	ELM02320G	.40	2	ELM029200	ELM02920G	.40
3	ELM031200	ELM03120G	.60	3	ELM033200	ELM03320G	.60	3	ELM039200	ELM03920G	.60
ELM Assemblies				ELM Assemblies				ELM Assemblies			
4	ELM041200	ELM04120G	.80	4	ELM043200	ELM04320G	.80	4	ELM049200	ELM04920G	.80
5	ELM051200	ELM05120G	1.00	5	ELM053200	ELM05320G	1.00	5	ELM059200	ELM05920G	1.00
6	ELM061200	ELM06120G	1.20	6	ELM063200	ELM06320G	1.20	6	ELM069200	ELM06920G	1.20
7	ELM071200	ELM07120G	1.40	7	ELM073200	ELM07320G	1.40	7	ELM079200	ELM07920G	1.40
8	ELM081200	ELM08120G	1.60	8	ELM083200	ELM08320G	1.60	8	ELM089200	ELM08920G	1.60
9	ELM091200	ELM09120G	1.80	9	ELM093200	ELM09320G	1.80	9	ELM099200	ELM09920G	1.80
10	ELM101200	ELM10120G	2.00	10	ELM103200	ELM10320G	2.00	10	ELM109200	ELM10920G	2.00
11	ELM111200	ELM11120G	2.20	11	ELM113200	ELM11320G	2.20	11	ELM119200	ELM11920G	2.20
12	ELM121200	ELM12120G	2.40	12	ELM123200	ELM12320G	2.40	12	ELM129200	ELM12920G	2.40
13	ELM131200	ELM13120G	2.60	13	ELM133200	ELM13320G	2.60	13	ELM139200	ELM13920G	2.60
14	ELM141200	ELM14120G	2.80	14	ELM143200	ELM14320G	2.80	14	ELM149200	ELM14920G	2.80
15	ELM151200	ELM15120G	3.00	15	ELM153200	ELM15320G	3.00	15	ELM159200	ELM15920G	3.00
16	ELM161200	ELM16120G	3.20	16	ELM163200	ELM16320G	3.20	16	ELM169200	ELM16920G	3.20
17	ELM171200	ELM17120G	3.40	17	ELM173200	ELM17320G	3.40	17	ELM179200	ELM17920G	3.40
18	ELM181200	ELM18120G	3.60	18	ELM183200	ELM18320G	3.60	18	ELM189200	ELM18920G	3.60
19	ELM191200	ELM19120G	3.80	19	ELM193200	ELM19320G	3.80	19	ELM199200	ELM19920G	3.80
20	ELM201200	ELM20120G	4.00	20	ELM203200	ELM20320G	4.00	20	ELM209200	ELM20920G	4.00

APPROVALS:



Consult factory for specific product recognitions

SPECIFICATIONS:

Current Rating: 15A
Operating Voltage: 300V
Insulation Resistance: >10⁵ Megohms
Dielectric Withstanding: <3000V
Wire Pullout Force:
 Per UL 486E, Section 14

MATERIALS:

Housing: PBT, UL 94V-0, black or green
Contact: Brass, tin-lead finish
Clamp Screw: Copper alloy, nickel finish
Wire clamp: Copper alloy, nickel finish

INSTALLATION:

Wire Range: 12-28 AWG
Wire Strip Length: .250"
Recommended Tightening Torque: 7 lb-in. (0.79N-m)
Hole Diameter: .051 min.

Amphenol Pcd

ELM Fixed Terminal Blocks

Modular, Assembled-to-Size

5.0mm (.197")

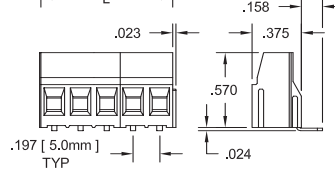
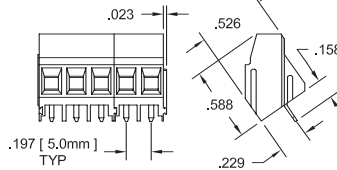
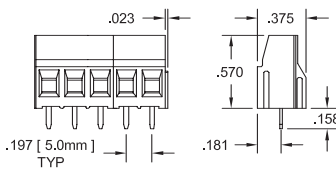
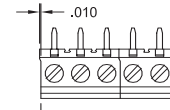
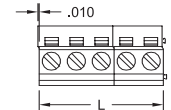
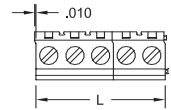
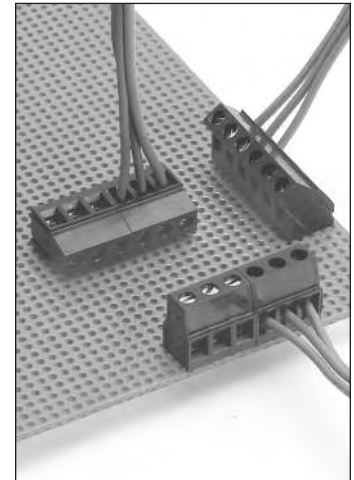

Catalog #		Catalog #		L (mm)	Catalog #		Catalog #		L (mm)	Catalog #		Catalog #		L (mm)
Pos	Black	Green	Pos		Black	Green	Pos	Black		Green	Pos	Black	Green	
ELM Modules														
2	ELM021100	ELM02110G	10.0	2	ELM023100	ELM02310G	10.0	2	ELM029100	ELM02910G	10.0			
3	ELM031100	ELM03110G	15.0	3	ELM033100	ELM03310G	15.0	3	ELM039100	ELM03910G	15.0			
ELM Assemblies														
4	ELM041100	ELM04110G	20.0	4	ELM043100	ELM04310G	20.0	4	ELM049100	ELM04910G	20.0			
5	ELM051100	ELM05110G	25.0	5	ELM053100	ELM05310G	25.0	5	ELM059100	ELM05910G	25.0			
6	ELM061100	ELM06110G	30.0	6	ELM063100	ELM06310G	30.0	6	ELM069100	ELM06910G	30.0			
7	ELM071100	ELM07110G	35.0	7	ELM073100	ELM07310G	35.0	7	ELM079100	ELM07910G	35.0			
8	ELM081100	ELM08110G	40.0	8	ELM083100	ELM08310G	40.0	8	ELM089100	ELM08910G	40.0			
9	ELM091100	ELM09110G	45.0	9	ELM093100	ELM09310G	45.0	9	ELM099100	ELM09910G	45.0			
10	ELM101100	ELM10110G	50.0	10	ELM103100	ELM10310G	50.0	10	ELM109100	ELM10910G	50.0			
11	ELM111100	ELM11110G	55.0	11	ELM113100	ELM11310G	55.0	11	ELM119100	ELM11910G	55.0			
12	ELM121100	ELM12110G	60.0	12	ELM123100	ELM12310G	60.0	12	ELM129100	ELM12910G	60.0			
13	ELM131100	ELM13110G	65.0	13	ELM133100	ELM13310G	65.0	13	ELM139100	ELM13910G	65.0			
14	ELM141100	ELM14110G	70.0	14	ELM143100	ELM14310G	70.0	14	ELM149100	ELM14910G	70.0			
15	ELM151100	ELM15110G	75.0	15	ELM153100	ELM15310G	75.0	15	ELM159100	ELM15910G	75.0			
16	ELM161100	ELM16110G	80.0	16	ELM163100	ELM16310G	80.0	16	ELM169100	ELM16910G	80.0			
17	ELM171100	ELM17110G	85.0	17	ELM173100	ELM17310G	85.0	17	ELM179100	ELM17910G	85.0			
18	ELM181100	ELM18110G	90.0	18	ELM183100	ELM18310G	90.0	18	ELM189100	ELM18910G	90.0			
19	ELM191100	ELM19110G	95.0	19	ELM193100	ELM19310G	95.0	19	ELM199100	ELM19910G	95.0			
20	ELM201100	ELM20110G	100.0	20	ELM203100	ELM20310G	100.0	20	ELM209100	ELM20910G	100.0			

INSTALLATION:

Wire Range: 12-28 AWG
Wire Strip Length: .250"
Recommended Tightening Torque:
 7 lb-in. (0.79N-m)
Hole Diameter: .051 min.

MATERIALS:

Housing: PBT, UL 94V-0, black or green
Contact: Brass, tin-lead finish
Clamp Screw: Copper alloy, nickel finish
Wire clamp: Copper alloy, nickel finish

SPECIFICATIONS:

Current Rating: 15A
Operating Voltage: 300V
Insulation Resistance: >10⁵ Megohms
Dielectric Withstanding: <3000V
Wire Pullout Force:
 Per UL 486E, Section 14

APPROVALS:



Consult factory for specific product recognitions

Interlocking Modules

The ELM family consists of precision molded 2- and 3-position screw termination modules with interlocking dovetails. Modules can be joined without loss of pin spacing, giving users the option of purchasing and stocking only the 2- and 3-position modules—and assembling to size in-house—in order to minimize inventory and maintain flexibility; or ordering product already assembled to size.

Options and Variations

ELM terminations are available in black or green.

Contact Amphenol Pcd for information on marking, hold-down mounting ears and other application-specific variations.

Amphenol Pcd

.200" (5.08mm)

ELMM Low-Profile, Angled Modular Terminal Block



High Board Density

The angled .200" (5.08mm) low profile ELMM series incorporates a 45° angle to maximize use of space by allowing terminal blocks to be stacked front-to-back, providing users full access to wires and screws even when the blocks are fully wired. The angled wire entry also facilitates training of wires in the desired direction. Blocks feature moving cage clamp termination.

Modular Construction

The terminal blocks are molded as 2- to 10-position modules with interlocking dovetails and can be assembled to length without loss of pin spacing. Longer connectors are readily assembled from modules. Users can purchase modules or assemblies to specific size, or stock a limited number of smaller modules and assemble in-house to suit requirements.

Options and Variations

Terminations are available in black or green. Contact Amphenol Pcd for information on marking and other application-specific variations.

Pos	Catalog # Black	Catalog # Green	L (In.)
ELMM Modules			
2	ELMM02100	ELMM02120	.40
3	ELMM03100	ELMM03120	.60
4	ELMM04100	ELMM04120	.80
5	ELMM05100	ELMM05120	1.00
6	ELMM06100	ELMM06120	1.20
7	ELMM07100	ELMM07120	1.40
8	ELMM08100	ELMM08120	1.60
9	ELMM09100	ELMM09120	1.80
10	ELMM10100	ELMM10120	2.00
ELMM Assemblies			
11	ELMM11100	ELMM11120	2.20
12	ELMM12100	ELMM12120	2.40
13	ELMM13100	ELMM13120	2.60
14	ELMM14100	ELMM14120	2.80
15	ELMM15100	ELMM15120	3.00
16	ELMM16100	ELMM16120	3.20
17	ELMM17100	ELMM17120	3.40
18	ELMM18100	ELMM18120	3.60
19	ELMM19100	ELMM19120	3.80
20	ELMM20100	ELMM20120	4.00

APPROVALS:



SPECIFICATIONS:

Current Rating: 10A
Operating Voltage: 300V
Insulation Resistance: 10³ Megohms
Dielectric Withstanding: 1600V
Wire Pullout Force:
Per UL 486E, Section 14

MATERIALS:

Housing: PBT, UL 94V-0, black or green
Contact: Brass, tin-lead finish
Clamp Screw: Copper alloy, nickel finish
Wire clamp: Copper alloy, nickel finish

INSTALLATION:

Wire Range: 16-28 AWG
Wire Strip Length: .250"
Recommended Tightening Torque: 7 lb-in. (0.79N-m)
Hole diameter: .055" min.

Amphenol Pcd

ESLM Low-Profile, Horizontal Modular Terminal Block

.200" (5.08mm)
5.0mm (.197")

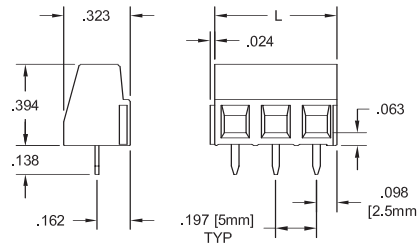
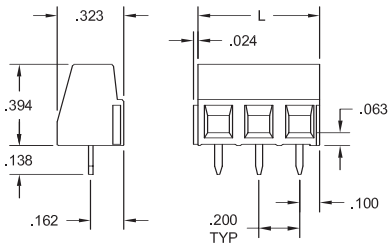

Pos	Catalog #	L (In.)	Pos	Catalog #	L (mm)
2	ESLM02200	.40	2	ESLM02100	10.0
3	ESLM03200	.60	3	ESLM03100	15.0
4	ESLM04200	.80	4	ESLM04100	20.0
5	ESLM05200	1.00	5	ESLM05100	25.0
6	ESLM06200	1.20	6	ESLM06100	30.0
7	ESLM07200	1.40	7	ESLM07100	35.0
8	ESLM08200	1.60	8	ESLM08100	40.0
9	ESLM09200	1.80	9	ESLM09100	45.0
10	ESLM10200	2.00	10	ESLM10100	50.0
11	ESLM11200	2.20	11	ESLM11100	55.0
12	ESLM12200	2.40	12	ESLM12100	60.0
13	ESLM13200	2.60	13	ESLM13100	65.0
14	ESLM14200	2.80	14	ESLM14100	70.0
15	ESLM15200	3.00	15	ESLM15100	75.0
16	ESLM16200	3.20	16	ESLM16100	80.0
17	ESLM17200	3.40	17	ESLM17100	85.0
18	ESLM18200	3.60	18	ESLM18100	90.0
19	ESLM19200	3.80	19	ESLM19100	95.0
20	ESLM20200	4.00	20	ESLM20100	100.0
21	ESLM21200	4.20	21	ESLM21100	105.0
22	ESLM22200	4.40	22	ESLM22100	110.0
23	ESLM23200	4.60	23	ESLM23100	115.0
24	ESLM24200	4.80	24	ESLM24100	120.0

Modular Construction

The .200" (5.08mm)/5.0mm (.197") low profile ESLM series terminal block features cage clamp wire termination and modular construction.

The terminal blocks are molded as 2- to 24-position modules with interlocking dovetails and can be assembled to length without loss of pin spacing. Longer connectors are readily assembled from modules. Users can purchase modules or assemblies to specific size, or stock a limited number of smaller modules and assemble in-house to suit requirements.

Options and Variations

Contact Amphenol Pcd for information on marking and other application-specific variations.

Available in black only.

MATERIALS:

Housing: Polyamide 6/6, UL 94V-0, black

Contact: Copper alloy, tin-lead finish

Clamp Screw: Copper alloy, nickel finish

Wire clamp: Copper alloy, nickel finish

SPECIFICATIONS:

Current Rating: 13.5A

Operating Voltage: 300V

Insulation Resistance: >10³ Megohms

INSTALLATION:

Wire Range: 14-30 AWG

Wire Strip Length: .197-.236"

Recommended Tightening Torque: 4.4 lb-in. (0.5N-m)

Hole Diameter: .043 min.

APPROVALS:



Amphenol Pcd

.200" (5.08mm)

EL1M/2M/3M Heavy-Duty Terminal Blocks Multi-Tier, Left Offset (Standard)



Heavy Duty

Multi-tier, .200" spacing heavy duty terminal blocks are rated at 20A, and combine a larger wire accommodation range and higher current rating with the enhanced board density provided by the multi-tier design. Moving cage clamp wire termination ensures high reliability.

Interlocking Modules

Blocks are available in 1-, 2- and 3-tier configurations. Each configuration consists of precision molded 2- and 3-position-wide modules with interlocking dovetails. Modules can be easily assembled to length. Users have the option of purchasing and stocking only the 2- and 3-position modules, and assembling to size in-house, in order to minimize inventory and maintain flexibility; or ordering product already assembled to size.

Options and Variations

Terminations are available in black or green. Contact Amphenol Pcd for information on marking and other application-specific variations.



EL1M Modules			EL2M Modules			EL3M Modules					
Pos	Catalog # Black	Catalog # Green	L (In.)	Pos	Catalog # Black	Catalog # Green	L (In.)	Pos	Catalog # Black	Catalog # Green	L (In.)
2	EL1M022B00	EL1M022G00	.40	4	EL2M042B00	EL2M042G00	.50	6	EL3M062B00	EL3M062G00	.50
3	EL1M032B00	EL1M032G00	.60	6	EL2M062B00	EL2M062G00	.70	9	EL3M092B00	EL3M092G00	.70
EL1M Assemblies			EL2M Assemblies			EL3M Assemblies					
4	EL1M042B00	EL1M042G00	.80	8	EL2M082B00	EL2M082G00	.90	12	EL3M122B00	EL3M122G00	.90
5	EL1M052B00	EL1M052G00	1.00	10	EL2M102B00	EL2M102G00	1.10	15	EL3M152B00	EL3M152G00	1.10
6	EL1M062B00	EL1M062G00	1.20	12	EL2M122B00	EL2M122G00	1.30	18	EL3M182B00	EL3M182G00	1.30
7	EL1M072B00	EL1M072G00	1.40	14	EL2M142B00	EL2M142G00	1.50	21	EL3M212B00	EL3M212G00	1.50
8	EL1M082B00	EL1M082G00	1.60	16	EL2M162B00	EL2M162G00	1.70	24	EL3M242B00	EL3M242G00	1.70
9	EL1M092B00	EL1M092G00	1.80	18	EL2M182B00	EL2M182G00	1.90	27	EL3M272B00	EL3M272G00	1.90
10	EL1M102B00	EL1M102G00	2.00	20	EL2M202B00	EL2M202G00	2.10	30	EL3M302B00	EL3M302G00	2.10
11	EL1M112B00	EL1M112G00	2.20	22	EL2M222B00	EL2M222G00	2.30	33	EL3M332B00	EL3M332G00	2.30
12	EL1M122B00	EL1M122G00	2.40	24	EL2M242B00	EL2M242G00	2.50	36	EL3M362B00	EL3M362G00	2.50
13	EL1M132B00	EL1M132G00	2.60	26	EL2M262B00	EL2M262G00	2.70	39	EL3M392B00	EL3M392G00	2.70
14	EL1M142B00	EL1M142G00	2.80	28	EL2M282B00	EL2M282G00	2.90	42	EL3M422B00	EL3M422G00	2.90
15	EL1M152B00	EL1M152G00	3.00	30	EL2M302B00	EL2M302G00	3.10	45	EL3M452B00	EL3M452G00	3.10
16	EL1M162B00	EL1M162G00	3.20	32	EL2M322B00	EL2M322G00	3.30	48	EL3M482B00	EL3M482G00	3.30
17	EL1M172B00	EL1M172G00	3.40	34	EL2M342B00	EL2M342G00	3.50	51	EL3M512B00	EL3M512G00	3.50
18	EL1M182B00	EL1M182G00	3.60	36	EL2M362B00	EL2M362G00	3.70	54	EL3M542B00	EL3M542G00	3.70
19	EL1M192B00	EL1M192G00	3.80	38	EL2M382B00	EL2M382G00	3.90	57	EL3M572B00	EL3M572G00	3.90
20	EL1M202B00	EL1M202G00	4.00	40	EL2M402B00	EL2M402G00	4.10	60	EL3M602B00	EL3M602G00	4.10
21	EL1M212B00	EL1M212G00	4.20	42	EL2M422B00	EL2M422G00	4.30	63	EL3M632B00	EL3M632G00	4.30
22	EL1M222B00	EL1M222G00	4.40	44	EL2M442B00	EL2M442G00	4.50	66	EL3M662B00	EL3M662G00	4.50

APPROVALS:



Consult factory for specific product recognitions

SPECIFICATIONS:

Current Rating: 20A
Operating Voltage: 300V
Insulation Resistance: >10⁵ Megohms
Dielectric Withstanding: <3000V
Wire Pullout Force:
 Per UL 486E, Section 14

MATERIALS:

Housing: PA, UL 94V-0, black or green
Contact: Copper alloy, tin-lead finish
Clamp Screw: Copper alloy, nickel finish
Wire clamp: Copper alloy, nickel finish

INSTALLATION:

Wire Range: 12-30 AWG
Wire Strip Length: .310"
Recommended Tightening Torque:
 7 lb-in. (0.79N-m)
Hole Diameter: .051 min.

Special Heavy-Duty Terminal Blocks 2-Tier, Right Offset/4-Tier

.200" (5.08mm)

EL2M 2-Tier—Right Offset

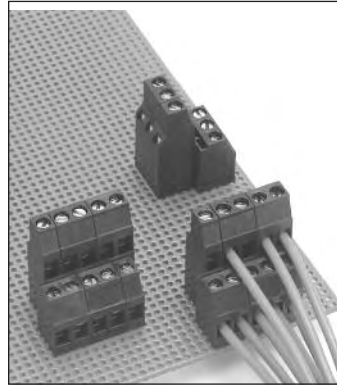
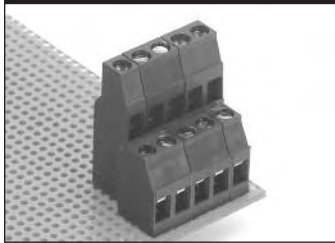

EL2M RIGHT OFFSET VARIATION

Identical in all respects to the 2-tier EL2M family shown on page 60 (facing), except that the upper row is offset to the right, providing additional system I/O and packaging alternates. Users have the option of purchasing modules separately, and assembling to size in-house, in order to minimize inventory; or ordering product already assembled to size.

Note: 4- and 8-position modules are not available in limited quantities, and consequently are not included in the part number table at left. Contact Amphenol Pcd for details.

Options and Variations

Terminations are available in black or green. Contact Amphenol Pcd for information on marking and other application-specific variations.

APPROVALS:



Consult factory for specific product recognitions

ESTT 4-Tier Tall Profile

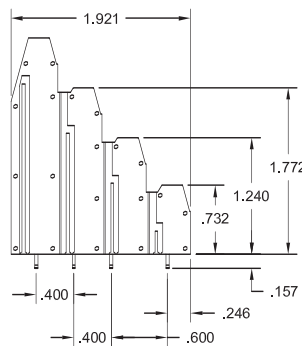
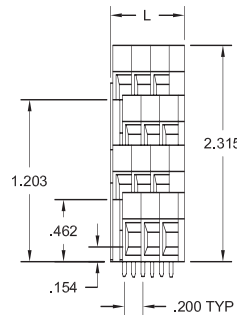
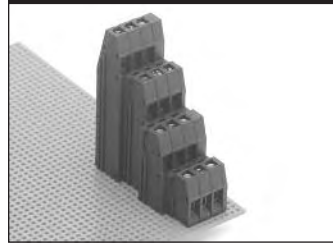

LEFT SIDE PROFILE

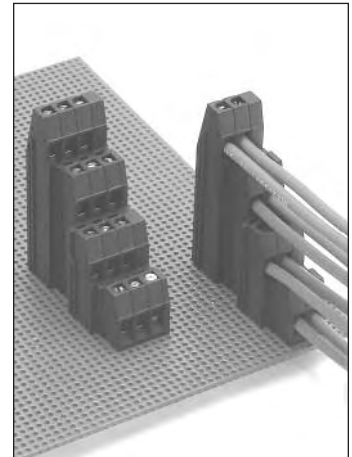

ESTT 4-TIER TALL TOWER

The .200" (5.08mm) 4-tier ESTT, aimed at maximum board density or unique packaging requirements, is the tallest vertical block available.

Blocks feature moving cage clamp wire terminations.

Supplied pre-assembled to size, and available only in black.

SPECIFICATIONS:

Current Rating: 24A

Operating Voltage: 300V

Insulation Resistance: >10³ Megohms

Contact Resistance: <15milliohms

INSTALLATION:

Wire Range: 12-30 AWG

Wire Strip Length: .256-.276"

Recommended Tightening Torque:
4.4 lb-in. (0.5N-m)

Hole Diameter: .043 min.

MATERIALS:

Housing: Polyamide 6/6, UL 94V-0, black

Contact: Copper alloy, tin-lead finish

Clamp Screw: Copper alloy, nickel finish

Wire clamp: Copper alloy, nickel finish

APPROVALS:



Pos	Catalog # Black	Catalog # Green	L (In.)
6	EL2M064B00	EL2M064G00	.70
10	EL2M104B00	EL2M104G00	1.10
12	EL2M124B00	EL2M124G00	1.30
14	EL2M144B00	EL2M144G00	1.50
16	EL2M164B00	EL2M164G00	1.70
18	EL2M184B00	EL2M184G00	1.90
20	EL2M204B00	EL2M204G00	2.10
22	EL2M224B00	EL2M224G00	2.30
24	EL2M244B00	EL2M244G00	2.50
26	EL2M264B00	EL2M264G00	2.70
28	EL2M284B00	EL2M284G00	2.90
30	EL2M304B00	EL2M304G00	3.10
32	EL2M324B00	EL2M324G00	3.30
34	EL2M344B00	EL2M344G00	3.50
36	EL2M364B00	EL2M364G00	3.70
38	EL2M384B00	EL2M384G00	3.90
40	EL2M404B00	EL2M404G00	4.10
42	EL2M424B00	EL2M424G00	4.30
44	EL2M444B00	EL2M444G00	4.50

SPECIFICATIONS:

See facing page

MATERIALS:

See facing page

INSTALLATION:

See facing page

Pos	Catalog #	L (In.)
8	ESTT08270	.593
12	ESTT12270	.793
16	ESTT16270	.993
20	ESTT20270	1.193
24	ESTT24270	1.393
28	ESTT28270	1.593
32	ESTT32270	1.793
36	ESTT36270	1.993
40	ESTT40270	2.193
44	ESTT44270	2.393
48	ESTT48270	2.593

Amphenol Pcd

.200" (5.08mm)
5.0mm (.197")

ESLT Multi-Tier Terminal Blocks Low-Profile Modular Assembly

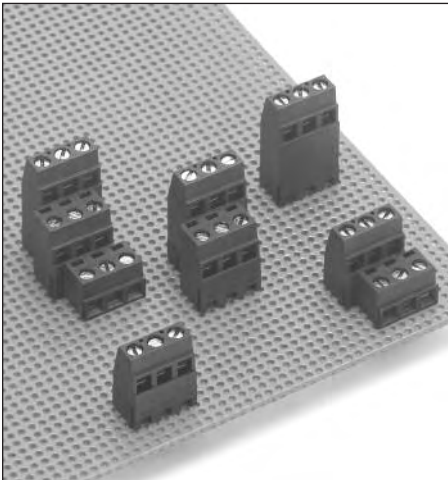

Enhanced Density

Multi-tier, .200"/5.0mm spacing terminal blocks are rated at 13.5A and combine low profile with the enhanced board density provided by the multi-tier design. Moving cage clamp wire termination ensures high reliability.

Interlocking Modules

Blocks range to 3 tiers high and are available in five different configurations: full (3 tiers), 2nd/3rd tier, 1st/2nd tier, 2nd-tier-only and 3rd-tier-only. Each configuration consists of 2- and 3-position-wide modules with interlocking dovetails. Modules can be easily assembled to length. Users have the option of purchasing and stocking only the 2- and 3-position modules, and assembling to size in-house, in order to minimize inventory and maintain flexibility; or ordering product already assembled to size.

Modules are also back-to-front stackable for maximum system flexibility with a minimum number of different modules. A 1st/2nd tier module, for example, can be placed on a board in front of a 3-tier-only module.

Available in black only.

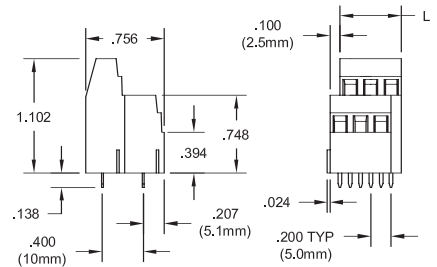
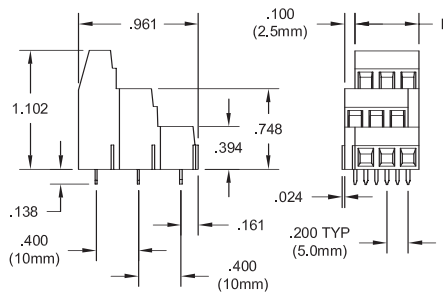
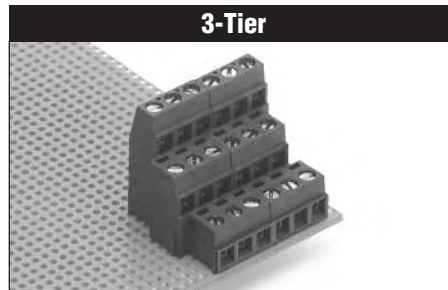

	Pos	Catalog #	L
.200" Pitch			
Modules	6	ESLT06260	.400"
	9	ESLT09260	.600"
Assemblies	12	ESLT12260	.800"
	15	ESLT15260	1.000"
	18	ESLT18260	1.200"
	21	ESLT21260	1.400"
	24	ESLT24260	1.600"
	27	ESLT27260	1.800"
	30	ESLT30260	2.000"
	33	ESLT33260	2.200"
36	ESLT36260	2.400"	
5mm Pitch			
Modules	6	ESLT06160	10.2mm
	9	ESLT09160	15.2mm
Assemblies	12	ESLT12160	20.3mm
	15	ESLT15160	25.4mm
	18	ESLT18160	30.5mm
	21	ESLT21160	35.6mm
	24	ESLT24160	40.6mm
	27	ESLT27160	45.7mm
	30	ESLT30160	50.8mm
	33	ESLT33160	55.9mm
36	ESLT36160	61.0mm	

	Pos	Catalog #	L
.200" Pitch			
Modules	4	ESLT04250	.400"
	6	ESLT06250	.600"
Assemblies	8	ESLT08250	.800"
	10	ESLT10250	1.000"
	12	ESLT12250	1.200"
	14	ESLT14250	1.400"
	16	ESLT16250	1.600"
	18	ESLT18250	1.800"
	20	ESLT20250	2.000"
	22	ESLT22250	2.200"
24	ESLT24250	2.400"	
5mm Pitch			
Modules	4	ESLT04150	10.2mm
	6	ESLT06150	15.2mm
Assemblies	8	ESLT08150	20.3mm
	10	ESLT10150	25.4mm
	12	ESLT12150	30.5mm
	14	ESLT14150	35.6mm
	16	ESLT16150	40.6mm
	18	ESLT18150	45.7mm
	20	ESLT20150	50.8mm
	22	ESLT22150	55.9mm
24	ESLT24150	61.0mm	

APPROVALS:



SPECIFICATIONS:

Current Rating: 13.5A
Operating Voltage: 300V
Insulation Resistance: >10³ Megohms
Contact Resistance: <15milliohms

Amphenol Pcd

ESLT Multi-Tier Terminal Blocks Low-Profile Modular Assembly

.200" (5.08mm)
5.0mm (.197")



1st / 2nd Tiers



3rd Tier Only



2nd Tier Only

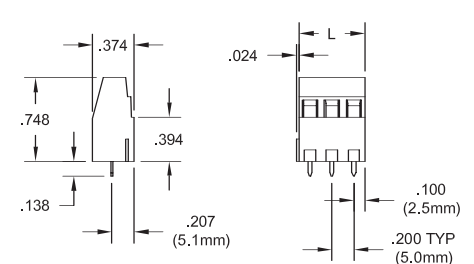
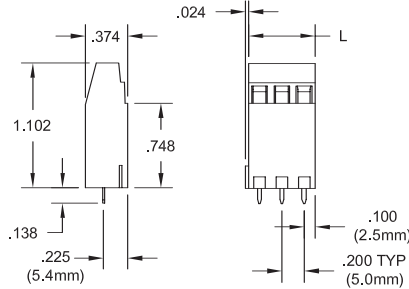

	Pos	Catalog #	L		Pos	Catalog #	L		Pos	Catalog #	L
	.200" Pitch				.200" Pitch				.200" Pitch		
Modules	4	ESLT04240	.400"	Modules	2	ESLT02230	.400"	Modules	2	ESLT02220	.400"
	6	ESLT06240	.600"		3	ESLT03230	.600"		3	ESLT03220	.600"
Assemblies	8	ESLT08240	.800"	Assemblies	4	ESLT04230	.800"	Assemblies	4	ESLT04220	.800"
	10	ESLT10240	1.000"		5	ESLT05230	1.000"		5	ESLT05220	1.000"
	12	ESLT12240	1.200"		6	ESLT06230	1.200"		6	ESLT06220	1.200"
	14	ESLT14240	1.400"		7	ESLT07230	1.400"		7	ESLT07220	1.400"
	16	ESLT16240	1.600"		8	ESLT08230	1.600"		8	ESLT08220	1.600"
	18	ESLT18240	1.800"		9	ESLT09230	1.800"		9	ESLT09220	1.800"
	20	ESLT20240	2.000"		10	ESLT10230	2.000"		10	ESLT10220	2.000"
	22	ESLT22240	2.200"		11	ESLT11230	2.200"		11	ESLT11220	2.200"
24	ESLT24240	2.400"	12	ESLT12230	2.400"	12	ESLT12220	2.400"			
	5mm Pitch				5mm Pitch				5mm Pitch		
Modules	4	ESLT04140	10.2mm	Modules	2	ESLT02130	10.2mm	Modules	2	ESLT02120	10.2mm
	6	ESLT06140	15.2mm		3	ESLT03130	15.2mm		3	ESLT03120	15.2mm
Assemblies	8	ESLT08140	20.3mm	Assemblies	4	ESLT04130	20.3mm	Assemblies	4	ESLT04120	20.3mm
	10	ESLT10140	25.4mm		5	ESLT05130	25.4mm		5	ESLT05120	25.4mm
	12	ESLT12140	30.5mm		6	ESLT06130	30.5mm		6	ESLT06120	30.5mm
	14	ESLT14140	35.6mm		7	ESLT07130	35.6mm		7	ESLT07120	35.6mm
	16	ESLT16140	40.6mm		8	ESLT08130	40.6mm		8	ESLT08120	40.6mm
	18	ESLT18140	45.7mm		9	ESLT09130	45.7mm		9	ESLT09120	45.7mm
	20	ESLT20140	50.8mm		10	ESLT10130	50.8mm		10	ESLT10120	50.8mm
	22	ESLT22140	55.9mm		11	ESLT11130	55.9mm		11	ESLT11120	55.9mm
24	ESLT24140	61.0mm	12	ESLT12130	61.0mm	12	ESLT12120	61.0mm			

MATERIALS:

Housing: Polyamide 6/6, UL 94V-0, black
Contact: Copper alloy, tin-lead finish
Clamp Screw: Copper alloy, nickel finish
Wire clamp: Copper alloy, nickel finish

INSTALLATION:

Wire Range: 14-30 AWG
Wire Strip Length: .197-.236"
Recommended Tightening Torque: 4.4 lb-in. (0.5N-m)
Hole Diameter: .043 min.

Amphenol Pcd

.200" (5.08mm)
5.0mm (.197")

ESMT Multi-Tier Terminal Blocks Mid-Profile Modular Assembly



Enhanced Density

Multi-tier, .200"/5.0mm spacing terminal blocks are rated at 17.5A and provide enhanced board density as well as system flexibility. Moving cage clamp wire termination ensures high reliability.

Interlocking Modules

Blocks range to 3 tiers high and are available in five different configurations: full (3 tiers), 2nd/3rd tier, 1st/2nd tier, 2nd-tier-only and 3rd-tier-only. Each configuration consists of 2- and 3-position-wide modules with interlocking dovetails. Modules can be easily assembled to length. Users have the option of purchasing and stocking only the 2- and 3-position modules, and assembling to size in-house, in order to minimize inventory and maintain flexibility; or ordering product already assembled to size.

Modules are also back-to-front stackable for maximum system flexibility with a minimum number of different modules. A 1st/2nd tier module, for example, can be placed on a board in front of a 3-tier-only module.

Available in black only.

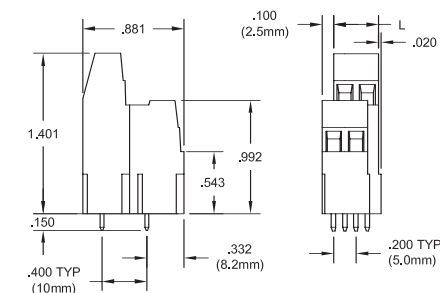
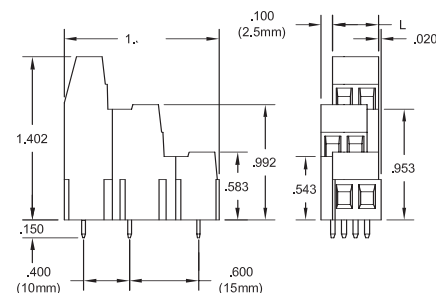

	Pos	Catalog #	L
.200" Pitch			
Modules	6	ESMT06260	.400"
	9	ESMT09260	.600"
Assemblies	12	ESMT12260	.800"
	15	ESMT15260	1.000"
	18	ESMT18260	1.200"
	21	ESMT21260	1.400"
	24	ESMT24260	1.600"
	27	ESMT27260	1.800"
	30	ESMT30260	2.000"
	33	ESMT33260	2.200"
	36	ESMT36260	2.400"
	5mm Pitch		
Modules	6	ESMT06160	10.2mm
	9	ESMT09160	15.2mm
Assemblies	12	ESMT12160	20.3mm
	15	ESMT15160	25.4mm
	18	ESMT18160	30.5mm
	21	ESMT21160	35.6mm
	24	ESMT24160	40.6mm
	27	ESMT27160	45.7mm
	30	ESMT30160	50.8mm
	33	ESMT33160	55.9mm
36	ESMT36160	61.0mm	

	Pos	Catalog #	L
.200" Pitch			
Modules	4	ESMT04250	.400"
	6	ESMT06250	.600"
Assemblies	8	ESMT08250	.800"
	10	ESMT10250	1.000"
	12	ESMT12250	1.200"
	14	ESMT14250	1.400"
	16	ESMT16250	1.600"
	18	ESMT18250	1.800"
	20	ESMT20250	2.000"
	22	ESMT22250	2.200"
	24	ESMT24250	2.400"
	5mm Pitch		
Modules	4	ESMT04150	10.2mm
	6	ESMT06150	15.2mm
Assemblies	8	ESMT08150	20.3mm
	10	ESMT10150	25.4mm
	12	ESMT12150	30.5mm
	14	ESMT14150	35.6mm
	16	ESMT16150	40.6mm
	18	ESMT18150	45.7mm
	20	ESMT20150	50.8mm
	22	ESMT22150	55.9mm
24	ESMT24150	61.0mm	

APPROVALS:



SPECIFICATIONS:

Current Rating: 17.5A
Operating Voltage: 300V
Insulation Resistance: >10³ Megohms
Contact Resistance: <15milliohms

Amphenol Pcd

ESMT Multi-Tier Terminal Blocks Mid-Profile Modular Assembly

.200" (5.08mm)
5.0mm (.197")



1st / 2nd Tiers



3rd Tier Only



2nd Tier Only

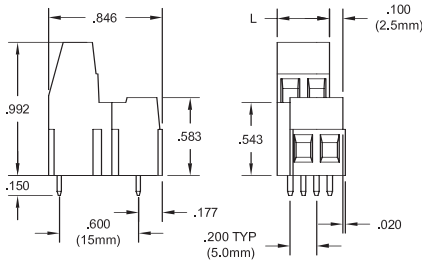

	Pos	Catalog #	L		Pos	Catalog #	L		Pos	Catalog #	L
	.200" Pitch				.200" Pitch				.200" Pitch		
Modules	4	ESMT04240	.400"	Modules	2	ESMT02230	.400"	Modules	2	ESMT02220	.400"
	6	ESMT06240	.600"		3	ESMT03230	.600"		3	ESMT03220	.600"
Assemblies	8	ESMT08240	.800"	Assemblies	4	ESMT04230	.800"	Assemblies	4	ESMT04220	.800"
	10	ESMT10240	1.000"		5	ESMT05230	1.000"		5	ESMT05220	1.000"
	12	ESMT12240	1.200"		6	ESMT06230	1.200"		6	ESMT06220	1.200"
	14	ESMT14240	1.400"		7	ESMT07230	1.400"		7	ESMT07220	1.400"
	16	ESMT16240	1.600"		8	ESMT08230	1.600"		8	ESMT08220	1.600"
	18	ESMT18240	1.800"		9	ESMT09230	1.800"		9	ESMT09220	1.800"
	20	ESMT20240	2.000"		10	ESMT10230	2.000"		10	ESMT10220	2.000"
	22	ESMT22240	2.200"		11	ESMT11230	2.200"		11	ESMT11220	2.200"
	24	ESMT24240	2.400"		12	ESMT12230	2.400"		12	ESMT12220	2.400"
		5mm Pitch				5mm Pitch				5mm Pitch	
Modules	4	ESMT04140	10.2mm	Modules	2	ESMT02130	10.2mm	Modules	2	ESMT02120	10.2mm
	6	ESMT06140	15.2mm		3	ESMT03130	15.2mm		3	ESMT03120	15.2mm
Assemblies	8	ESMT08140	20.3mm	Assemblies	4	ESMT04130	20.3mm	Assemblies	4	ESMT04120	20.3mm
	10	ESMT10140	25.4mm		5	ESMT05130	25.4mm		5	ESMT05120	25.4mm
	12	ESMT12140	30.5mm		6	ESMT06130	30.5mm		6	ESMT06120	30.5mm
	14	ESMT14140	35.6mm		7	ESMT07130	35.6mm		7	ESMT07120	35.6mm
	16	ESMT16140	40.6mm		8	ESMT08130	40.6mm		8	ESMT08120	40.6mm
	18	ESMT18140	45.7mm		9	ESMT09130	45.7mm		9	ESMT09120	45.7mm
	20	ESMT20140	50.8mm		10	ESMT10130	50.8mm		10	ESMT10120	50.8mm
	22	ESMT22140	55.9mm		11	ESMT11130	55.9mm		11	ESMT11120	55.9mm
	24	ESMT24140	61.0mm		12	ESMT12130	61.0mm		12	ESMT12120	61.0mm

MATERIALS:

Housing: Polyamide 6/6, UL 94V-0, black
Contact: Copper alloy, tin-lead finish
Clamp Screw: Copper alloy, nickel finish
Wire clamp: Copper alloy, nickel finish

INSTALLATION:

Wire Range: 12-30 AWG
Wire Strip Length: .216-.256"
Recommended Tightening Torque: 4.4 lb-in. (0.5N-m)
Hole Diameter: .043 min.

Amphenol Pcd

.200" (5.08mm)
5.0mm (.197")

ESTT Multi-Tier Terminal Blocks Tall-Profile Modular Assembly

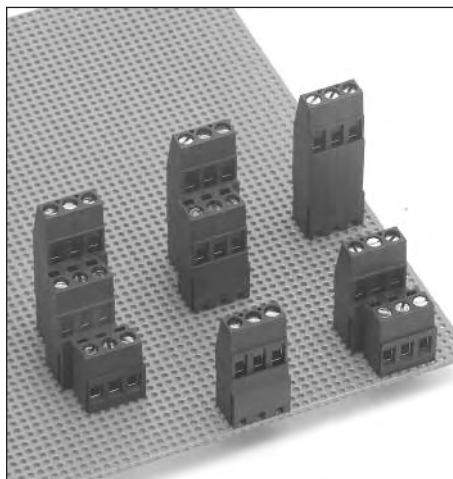

Enhanced Density

Multi-tier, .200"/5.0mm spacing terminal blocks are rated at 24A and provide high current capacity and enhanced board density as well as system flexibility. Moving cage clamp wire termination ensures high reliability.

Interlocking Modules

Blocks range to 3 tiers high and are available in five different configurations: full (3 tiers), 2nd/3rd tier, 1st/2nd tier, 2nd-tier-only and 3rd-tier-only. Each configuration consists of 2- and 3-position-wide modules with interlocking dovetails. Modules can be easily assembled to length. Users have the option of purchasing and stocking only the 2- and 3-position modules, and assembling to size in-house, in order to minimize inventory and maintain flexibility; or ordering product already assembled to size.

Modules are also back-to-front stackable for maximum system flexibility with a minimum number of different modules. A 1st/2nd tier module, for example, can be placed on a board in front of a 3-tier-only module.

Available in black only.

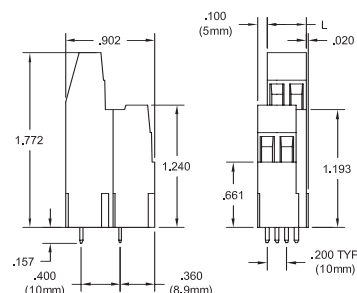
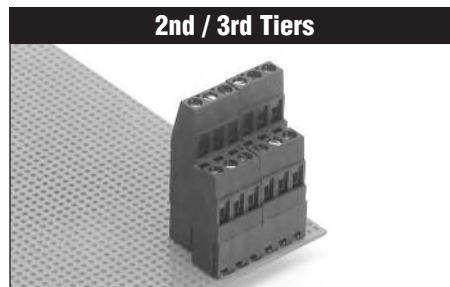
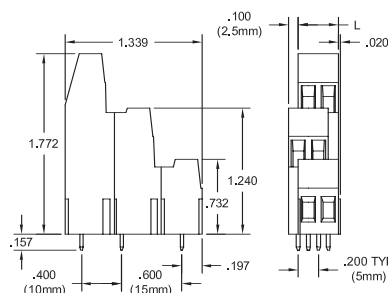
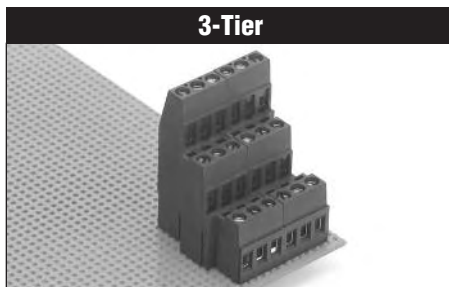

	Pos	Catalog #	L
.200" Pitch			
Modules	6	ESTT06260	.400"
	9	ESTT09260	.600"
Assemblies	12	ESTT12260	.800"
	15	ESTT15260	1.000"
	18	ESTT18260	1.200"
	21	ESTT21260	1.400"
	24	ESTT24260	1.600"
	27	ESTT27260	1.800"
	30	ESTT30260	2.000"
	33	ESTT33260	2.200"
36	ESTT36260	2.400"	
5mm Pitch			
Modules	6	ESTT06160	10.2mm
	9	ESTT09160	15.2mm
Assemblies	12	ESTT12160	20.3mm
	15	ESTT15160	25.4mm
	18	ESTT18160	30.5mm
	21	ESTT21160	35.6mm
	24	ESTT24160	40.6mm
	27	ESTT27160	45.7mm
	30	ESTT30160	50.8mm
	33	ESTT33160	55.9mm
36	ESTT36160	61.0mm	

	Pos	Catalog #	L
.200" Pitch			
Modules	4	ESTT04250	.400"
	6	ESTT06250	.600"
Assemblies	8	ESTT08250	.800"
	10	ESTT10250	1.000"
	12	ESTT12250	1.200"
	14	ESTT14250	1.400"
	16	ESTT16250	1.600"
	18	ESTT18250	1.800"
	20	ESTT20250	2.000"
	22	ESTT22250	2.200"
24	ESTT24250	2.400"	
5mm Pitch			
Modules	4	ESTT04150	10.2mm
	6	ESTT06150	15.2mm
Assemblies	12	ESTT08150	20.3mm
	10	ESTT10150	25.4mm
	12	ESTT12150	30.5mm
	14	ESTT14150	35.6mm
	16	ESTT16150	40.6mm
	18	ESTT18150	45.7mm
	20	ESTT20150	50.8mm
	22	ESTT22150	55.9mm
24	ESTT24150	61.0mm	

APPROVALS:



SPECIFICATIONS:

Current Rating: 24A
Operating Voltage: 300V
Insulation Resistance: >10³ Megohms
Contact Resistance: <15milliohms

Amphenol Pcd

ESTT Multi-Tier Terminal Blocks Tall-Profile Modular Assembly

.200" (5.08mm)
5.0mm (.197")



1st / 2nd Tiers



3rd Tier Only



2nd Tier Only

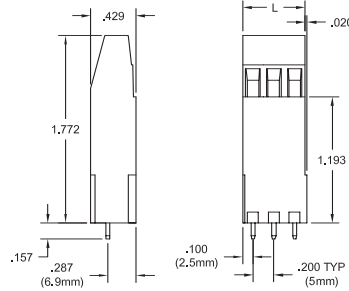
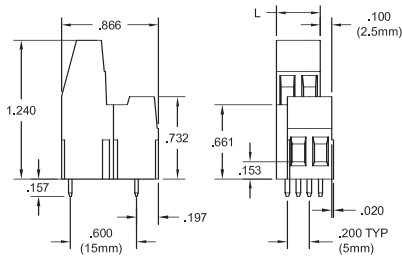

	Pos	Catalog #	L		Pos	Catalog #	L		Pos	Catalog #	L
	.200" Pitch				.200" Pitch				.200" Pitch		
Modules	4	ESTT04240	.400"	Modules	2	ESTT02230	.400"	Modules	2	ESTT02220	.400"
	6	ESTT06240	.600"		3	ESTT03230	.600"		3	ESTT03220	.600"
Assemblies	8	ESTT08240	.800"	Assemblies	4	ESTT04230	.800"	Assemblies	4	ESTT04220	.800"
	10	ESTT10240	1.000"		5	ESTT05230	1.000"		5	ESTT05220	1.000"
	12	ESTT12240	1.200"		6	ESTT06230	1.200"		6	ESTT06220	1.200"
	14	ESTT14240	1.400"		7	ESTT07230	1.400"		7	ESTT07220	1.400"
	16	ESTT16240	1.600"		8	ESTT08230	1.600"		8	ESTT08220	1.600"
	18	ESTT18240	1.800"		9	ESTT09230	1.800"		9	ESTT09220	1.800"
	20	ESTT20240	2.000"		10	ESTT10230	2.000"		10	ESTT10220	2.000"
	22	ESTT22240	2.200"		11	ESTT11230	2.200"		11	ESTT11220	2.200"
	24	ESTT24240	2.400"		12	ESTT12230	2.400"		12	ESTT12220	2.400"
		5.0mm Pitch				5.0mm Pitch				5.0mm Pitch	
Modules	4	ESTT04140	10.2mm	Modules	2	ESTT02130	10.2mm	Modules	2	ESTT02120	10.2mm
	6	ESTT06140	15.2mm		3	ESTT03130	15.2mm		3	ESTT03120	15.2mm
Assemblies	8	ESTT08140	20.3mm	Assemblies	4	ESTT04130	20.3mm	Assemblies	4	ESTT04120	20.3mm
	10	ESTT10140	25.4mm		5	ESTT05130	35.4mm		5	ESTT05120	25.4mm
	12	ESTT12140	30.5mm		6	ESTT06130	30.5mm		6	ESTT06120	30.5mm
	14	ESTT14140	35.6mm		7	ESTT07130	35.6mm		7	ESTT07120	35.6mm
	16	ESTT16140	40.6mm		8	ESTT08130	40.6mm		8	ESTT08120	40.6mm
	18	ESTT18140	45.7mm		9	ESTT09130	45.7mm		9	ESTT09120	45.7mm
	20	ESTT20140	50.8mm		10	ESTT10130	50.8mm		10	ESTT10120	50.8mm
	22	ESTT22140	55.9mm		11	ESTT11130	55.9mm		11	ESTT11120	55.9mm
	24	ESTT24140	61.0mm		12	ESTT12130	61.0mm		12	ESTT12120	61.0mm

MATERIALS:

Housing: Polyamide 6/6, UL 94V-0, black
Contact: Copper alloy, tin-lead finish
Clamp Screw: Copper alloy, nickel finish
Wire clamp: Copper alloy, nickel finish

INSTALLATION:

Wire Range: 12-30 AWG
Wire Strip Length: .256-.276"
Recommended Tightening Torque: 4.4 lb-in. (0.5N-m)
Hole Diameter: .043 min.

Amphenol Pcd

.250" (6.35mm)

ESPM Terminal Block High Current



Terminal block series on popular .250" spacing. Accepts 10 AWG, rated at 32A/300V.

Horizontal and angled configurations are available. Moving cage clamp wire termination.

Supplied as 2- and 3-position modules with interlocking dovetails, or assembled to size.

Available in black only.

SPECIFICATIONS:

- Current Rating:** 32A
- Operating Voltage:** 300V
- Insulation Resistance:** >10³ Megohms
- Contact Resistance:** <15 milliohms

INSTALLATION:

- Wire Range:** 10-24 AWG
- Wire Strip Length:** .280-.310"
- Recommended Tightening Torque:** 7.1 lb-in. (0.8N-m)
- Hole Diameter:** .051" min.

MATERIALS:

- Housing:** Polyamide 6/6, UL 94V-0, black
- Contact:** Copper alloy, tin finish
- Clamp Screw:** Copper alloy, nickel finish
- Wire clamp:** Copper alloy, nickel finish

APPROVALS:

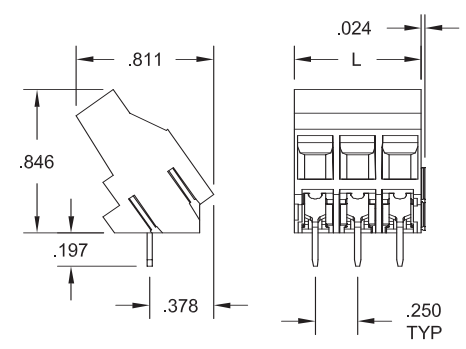
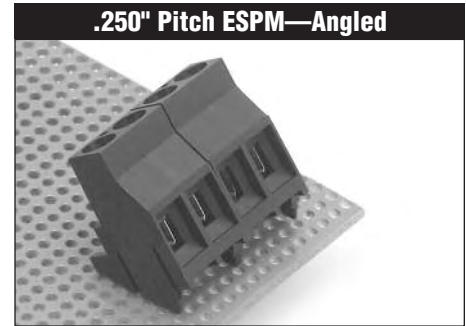

	Pos	Catalog # Horizontal	L (In.)		Pos	Catalog # Angled	L (In.)
Modules	2	ESPM02100	.500	Modules	2	ESPM02130	.500
	3	ESPM03100	.750		3	ESPM03130	.750
	4	ESPM04100	1.000		4	ESPM04130	1.000
	5	ESPM05100	1.250		5	ESPM05130	1.250
	6	ESPM06100	1.500		6	ESPM06130	1.500
	7	ESPM07100	1.750		7	ESPM07130	1.750
	8	ESPM08100	2.000		8	ESPM08130	2.000
	9	ESPM09100	2.250		9	ESPM09130	2.250
	10	ESPM10100	2.500		10	ESPM10130	2.500
	11	ESPM11100	2.750		11	ESPM11130	2.750
	12	ESPM12100	3.000		12	ESPM12130	3.000
	13	ESPM13100	3.250		13	ESPM13130	3.250
	Assemblies	14	ESPM14100		3.500	Assemblies	14
15		ESPM15100	3.750	15	ESPM15130		3.750
16		ESPM16100	4.000	16	ESPM16130		4.000
17		ESPM17100	4.250	17	ESPM17130		4.250
18		ESPM18100	4.500	18	ESPM18130		4.500
19		ESPM19100	4.750	19	ESPM19130		4.750
20		ESPM20100	5.000	20	ESPM20130		5.000
21		ESPM21100	5.250	21	ESPM21130		5.250
22		ESPM22100	5.500	22	ESPM22130		5.500
23		ESPM23100	5.750	23	ESPM23130		5.750
24		ESPM24100	6.000	24	ESPM24130		6.000

ESGM/ESMM/ESTM Terminal Blocks Mid, Angled and Tall Profile

.300" (7.62mm)
7.5mm (.295")

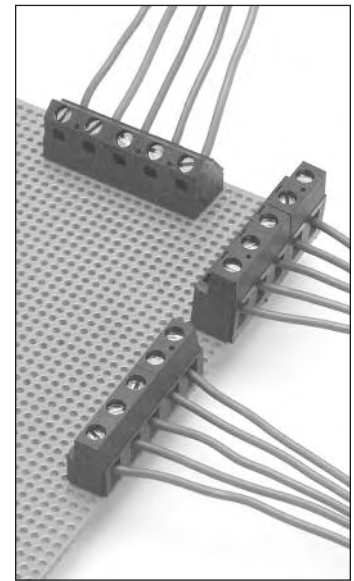

Pos	Catalog #	L	Pos	Catalog #	L	Pos	Catalog #	L
.300" Pitch			.300" Pitch			.300" Pitch		
2	ESGM02400	.600"	2	ESMM02430	.600"	2	ESTM02400	.600"
3	ESGM03400	.900"	3	ESMM03430	.900"	3	ESTM03400	.900"
4	ESGM04400	1.200"	4	ESMM04430	1.200"	4	ESTM04400	1.200"
5	ESGM05400	1.500"	5	ESMM05430	1.500"	5	ESTM05400	1.500"
6	ESGM06400	1.800"	6	ESMM06430	1.800"	6	ESTM06400	1.800"
7	ESGM07400	2.100"	7	ESMM07430	2.100"	7	ESTM07400	2.100"
8	ESGM08400	2.400"	8	ESMM08430	2.430"	8	ESTM08400	2.400"
9	ESGM09400	2.700"	9	ESMM09430	2.700"	9	ESTM09400	2.700"
10	ESGM10400	3.000"	10	ESMM10430	3.000"	10	ESTM10400	3.000"
11	ESGM11400	3.300"	11	ESMM11430	3.300"	11	ESTM11400	3.300"
12	ESGM12400	3.600"	12	ESMM12430	3.600"	12	ESTM12400	3.600"
7.5mm Pitch			7.5mm Pitch			7.5mm Pitch		
2	ESGM02300	15.0mm	2	ESMM02330	15.0mm	2	ESTM02300	15.0mm
3	ESGM03300	22.5mm	3	ESMM03330	22.5mm	3	ESTM03300	22.5mm
4	ESGM04300	30.0mm	4	ESMM04330	30.0mm	4	ESTM04300	30.0mm
5	ESGM05300	37.5mm	5	ESMM05330	37.5mm	5	ESTM05300	37.5mm
6	ESGM06300	45.0mm	6	ESMM06330	45.0mm	6	ESTM06300	45.0mm
7	ESGM07300	52.5mm	7	ESMM07330	52.5mm	7	ESTM07300	52.5mm
8	ESGM08300	60.0mm	8	ESMM08330	60.0mm	8	ESTM08300	60.0mm
9	ESGM09300	67.5mm	9	ESMM09330	67.5mm	9	ESTM09300	67.5mm
10	ESGM10300	75.0mm	10	ESMM10330	75.0mm	10	ESTM10300	75.0mm
11	ESGM11300	82.5mm	11	ESMM11330	82.5mm	11	ESTM11300	82.5mm
12	ESGM12300	90.0mm	12	ESMM12330	90.0mm	12	ESTM12300	90.0mm

Power I/O

Terminal block series on .300"/7.5mm spacing offers current ratings up to 24A and is well suited for power I/O applications. A variety of configurations are available. Moving cage clamp wire termination.

Supplied as 2- and 3-position modules with interlocking dovetails, or assembled to size

Low profile ESGM is rated at 17.5A, provides horizontal wire entry.

ESMM, also rated at 17.5A, offers the flexibility of angled termination.

High profile ESTM is rated at 24A. Horizontal entry.

Available in black only.

INSTALLATION:

Wire Range: 14-30 AWG (ESGM)
12-30 AWG (ESMM, ESTM)

Wire Strip Length: .260 - .280"

Recommended Tightening Torque:

4.4 lb-in. (0.5N-m)

Hole Diameter: .055" min.

MATERIALS:

Housing: Polyamide 6/6, UL 94V-0, black

Contact: Copper alloy, tin finish

Clamp Screw: Copper alloy, nickel finish

Wire clamp: Copper alloy, nickel finish

SPECIFICATIONS:

Current Rating: 17.5A (24A, ESTM only)

Operating Voltage: 300V

Contact Resistance: <15 milliohms

Insulation Resistance: >10³ Megohms

APPROVALS:



Amphenol Pcd

.375" (9.52mm)

ESPM Terminal Block High Current, High Voltage 600V



Power terminal block series on .375" spacing. Accepts 10 AWG, rated at 32A/600V.

Horizontal and angled configurations are available. Moving cage clamp wire termination.

Supplied as 2- and 3-position modules with interlocking dovetails, or assembled to size.

Available in black only.

SPECIFICATIONS:

- Current Rating:** 32A
- Operating Voltage:** 600V
- Insulation Resistance:** >10³ Megohms
- Contact Resistance:** <15 milliohms

INSTALLATION:

- Wire Range:** 10-24 AWG
- Wire Strip Length:** .280-.310"
- Recommended Tightening Torque:** 7.1 lb-in. (0.8N-m)
- Hole Diameter:** .051" min.

MATERIALS:

- Housing:** Polyamide 6/6, UL 94V-0, black
- Contact:** Copper alloy, tin finish
- Clamp Screw:** Copper alloy, nickel finish
- Wire clamp:** Copper alloy, nickel finish

APPROVALS:

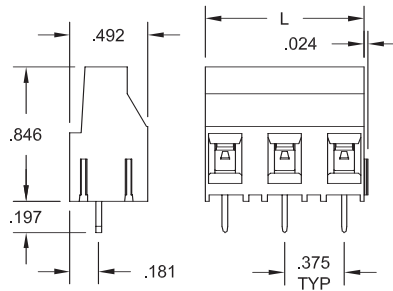

	Pos	Catalog # Horizontal	L (In.)		Pos	Catalog # Angled	L (In.)
Modules	2	ESPM02200	.750	Modules	2	ESPM02230	.750
	3	ESPM03200	1.125		3	ESPM03230	1.125
	4	ESPM04200	1.500		4	ESPM04230	1.500
Assemblies	5	ESPM05200	1.875	Assemblies	5	ESPM05230	1.875
	6	ESPM06200	2.250		6	ESPM06230	2.250
	7	ESPM07200	2.625		7	ESPM07230	2.625
	8	ESPM08200	3.000		8	ESPM08230	3.000
	9	ESPM09200	3.375		9	ESPM09230	3.375
	10	ESPM10200	3.750		10	ESPM10230	3.750
	11	ESPM11200	4.125		11	ESPM11230	4.125
	12	ESPM12200	4.500		12	ESPM12230	4.500

ELMP High Current 60A Block 4-Position Modules

**.400"
(10.16mm)**

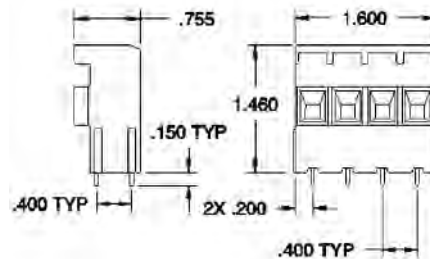
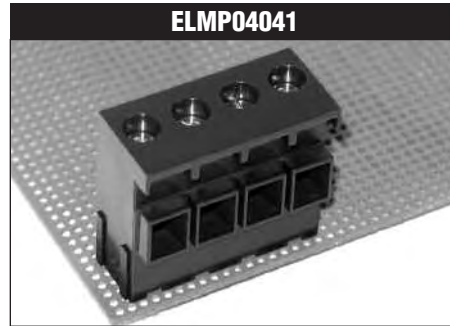

60A rated power terminal block series on .400" centers, accepts wire range 18-8 AWG. Moving cage clamp wire termination.

Supplied in 4-position modules with interlocking dovetails, or assembled to size.

Available in black only.

SPECIFICATIONS:

Current Rating: 60A

Operating Voltage: 300V

Insulation Resistance: $>10^3$ Megohms

Contact Resistance: <15 milliohms

INSTALLATION:

Wire Range: 8-18 AWG

Wire Strip Length: .430" (10.9mm)

Recommended Tightening Torque: 12 lb-in.

Hole Diameter: .063" min.

MATERIALS:

Housing: Polyamide 6/6, UL 94V-0, black

Contact: Copper alloy, tin finish

Clamp Screw: Steel, zinc plated

Wire clamp: Steel, zinc plated

APPROVALS:

Pending

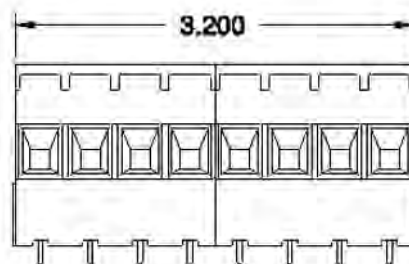

ALL OTHER DIMENSIONS SAME AS ELMP04041

Amphenol Pcd

15.0mm (.591")

ELMP High Current 75A Block 3-Position Modules

High Power three-position terminal block on 15.0 MM. Two contact positions accept 4 AWG, rated at 75A. The third—a sensor wire termination—accepts AWG 12-24.

SPECIFICATIONS:

Current Rating: 75A
Operating Voltage: 600V
Insulation Resistance: >103 Megohms
Contact Resistance: <15 milliohms

MATERIALS:

Housing: Polyamide 6/6, UL 94V-0, black
Contact: Copper alloy, tin finish
Clamp Screw: Steel, Zinc finish
Wire clamp: Steel, Zinc finish

INSTALLATION:

Power Wire Range: AWG 4-16
Sensor Wire Range: AWG 12-24
Wire Strip Length: .630"
Recommended Tightening Torque:
20 lb-in.
Hole Diameter: .063" min.

APPROVALS:

Pending

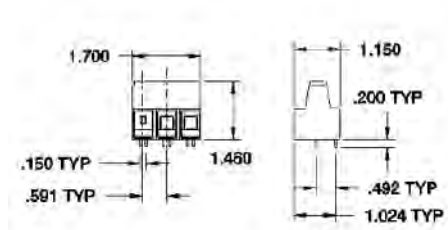

Pos	Catalog # Horizontal	L (In.)
3	ELMP03150	1.7

SPRING CLAMP BLOCKS AND PLUGS

Reduced Installation Labor

.150"/.200"
5.0mm

Screwless spring-clamp wire terminations—designed to simplify installation and reduce time and labor—are a feature of Amphenol Pcd's SC line of wire-to-board terminal blocks and two-piece plug and header interconnects.

TERMINAL BLOCKS

Versatile SCM spring clamp terminal blocks, are available in .200" and 5.0mm spacings and vertical, horizontal and angled wire entry configurations. Both .200" and 5.0mm blocks are molded to their respective sizes.

SMT Compatibility

The SCM is the only spring-clamp terminal block available that is suitable for SMT reflow solder PCB manufacturing processes as well as wave solder; providing users with additional flexibility and maximizing production efficiencies by eliminating secondary solder operations. Blocks are molded of ultra-high-temperature, glass-filled polyamide that will withstand temperatures of 260°C during PCB production.

Ease of Operation—Two Modes

Individual spring contact clamps are depressed to insert or remove wires by either actuating a lever or inserting a flat-bladed screwdriver in an actuation slot on the block.

Once wire is inserted and the spring

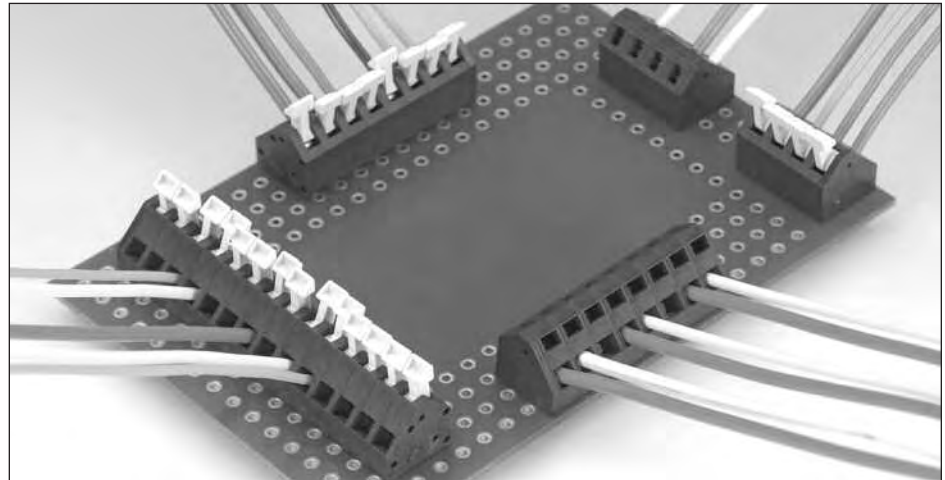

released, the stainless steel spring clamp maintains a consistent high pressure, gas-tight contact between the soft tin-lead-plated block contact and the wire. Ordering instructions for both block variations—screwdriver and lever actuation—are provided in the tables on the following pages.

High Current Rating

SCM blocks are rated at 20A/300V, the highest in the industry, and accepts 12 AWG wire.

Variations

Contact the factory for color and marking options.

PLUGS

The spring clamp wire termination concept is also incorporated in Amphenol Pcd's .150" spacing SCVF plug and .200" spacing SCFF. These plugs mate with standard PCD ELVH (pages 18, 20 and 22) and ELFH (pages 45–46 and 48–49) headers respectively, and with compatible competitive headers.

.150" DESIGN ON .200" CENTERS

Plugs and mating headers which feature the same basic shrouded contact design of the .150" ELV family, but on .200" centers—providing greater anti-cocking protection and extended creepage distance—are available as SCWF "Front-Front" plugs and ELWH headers. Contact us for details

Variations

SC plugs are available in black or green color, for system compatibility with the mating headers. Standard plating is tin-lead, with gold as an alternate.

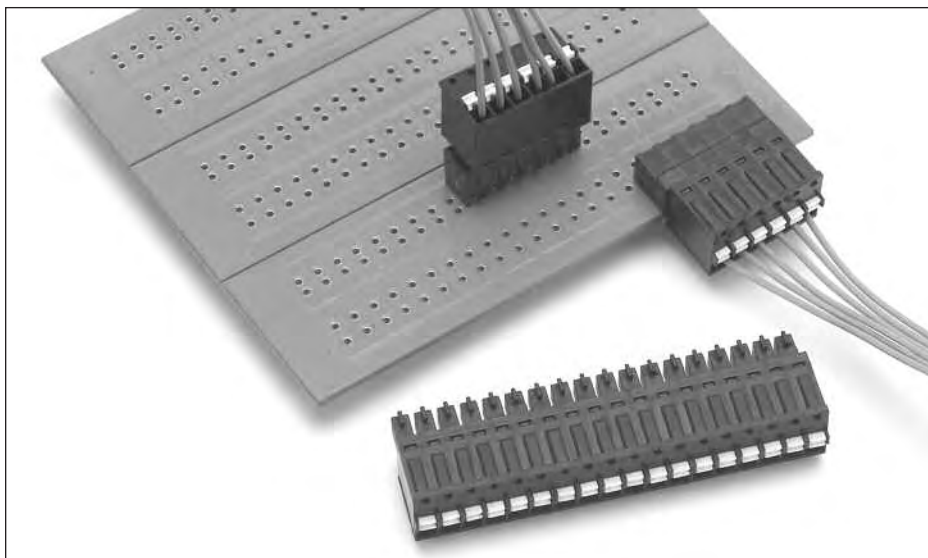

Amphenol Pcd

.200" (5.08mm)

SCM Wire-to-Board Terminal Blocks Spring Clamp Wire Termination



SCM .200" spring clamp terminal blocks are rated at 20A/300V—the highest in the industry—and are supplied in horizontal, angled and vertical configurations.

Two Modes of Operation

Individual spring contact clamps are depressed to insert or remove wires by either actuating a finger lever or inserting a flat-bladed screwdriver in an actuation slot on the block.

SMT Compatibility

The SCM is the only spring clamp terminal block available that is suitable for SMT reflow solder PCB manufacturing processes as well as wave solder; providing users with additional flexibility and maximizing production efficiencies by eliminating secondary solder operations. Blocks are molded of ultra-high-temperature, glass-filled polyamide that will withstand temperatures of 260°C during PCB production.

Variations

Contact Amphenol Pcd for color and marking options.

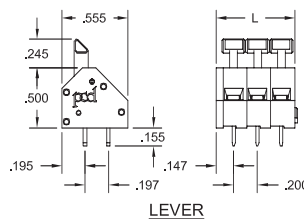

Pos	Catalog # w/o Lever	Catalog # Lever	L (In.)	Pos	Catalog # w/o Lever	Catalog # Lever	L (In.)	Pos	Catalog # w/o Lever	Catalog # Lever	L (In.)
2	SCM021000	SCM021000L	.460	2	SCM023000	SCM023000L	.460	2	SCM029000	SCM029000L	.460
3	SCM031000	SCM031000L	.660	3	SCM033000	SCM033000L	.660	3	SCM039000	SCM039000L	.660
4	SCM041000	SCM041000L	.860	4	SCM043000	SCM043000L	.860	4	SCM049000	SCM049000L	.860
5	SCM051000	SCM051000L	1.060	5	SCM053000	SCM053000L	1.060	5	SCM059000	SCM059000L	1.060
6	SCM061000	SCM061000L	1.260	6	SCM063000	SCM063000L	1.260	6	SCM069000	SCM069000L	1.260
7	SCM071000	SCM071000L	1.460	7	SCM073000	SCM073000L	1.460	7	SCM079000	SCM079000L	1.460
8	SCM081000	SCM081000L	1.660	8	SCM083000	SCM083000L	1.660	8	SCM089000	SCM089000L	1.660
9	SCM091000	SCM091000L	1.860	9	SCM093000	SCM093000L	1.860	9	SCM099000	SCM099000L	1.860
10	SCM101000	SCM101000L	2.060	10	SCM103000	SCM103000L	2.060	10	SCM109000	SCM109000L	2.060
11	SCM111000	SCM111000L	2.260	11	SCM113000	SCM113000L	2.260	11	SCM119000	SCM119000L	2.260
12	SCM121000	SCM121000L	2.460	12	SCM123000	SCM123000L	2.460	12	SCM129000	SCM129000L	2.460
13	SCM131000	SCM131000L	2.660	13	SCM133000	SCM133000L	2.660	13	SCM139000	SCM139000L	2.660
14	SCM141000	SCM141000L	2.860	14	SCM143000	SCM143000L	2.860	14	SCM149000	SCM149000L	2.860
15	SCM151000	SCM151000L	3.060	15	SCM153000	SCM153000L	3.060	15	SCM159000	SCM159000L	3.060
16	SCM161000	SCM161000L	3.260	16	SCM163000	SCM163000L	3.260	16	SCM169000	SCM169000L	3.260
17	SCM171000	SCM171000L	3.460	17	SCM173000	SCM173000L	3.460	17	SCM179000	SCM179000L	3.460
18	SCM181000	SCM181000L	3.660	18	SCM183000	SCM183000L	3.660	18	SCM189000	SCM189000L	3.660
19	SCM191000	SCM191000L	3.860	19	SCM193000	SCM193000L	3.860	19	SCM199000	SCM199000L	3.860
20	SCM201000	SCM201000L	4.060	20	SCM203000	SCM203000L	4.060	20	SCM209000	SCM209000L	4.060

APPROVALS:



SPECIFICATIONS:

Current Rating: 20A
Operating Voltage: 300V
Insulation Resistance: >10³ Megohms
Dielectric Withstanding: <1600V
Wire Pullout Force:
 Per UL 486E, Section 14

MATERIALS:

Housing/Lever: PA, UL 94V-0, black
Contact: Brass, tin-lead finish
Spring Clamp: Stainless steel

INSTALLATION:

Wire Range: 12-28 AWG
Wire Strip Length: .220"
Hole Diameter: .047 min.

Amphenol Pcd

SCM Wire-to-Board Terminal Blocks Spring Clamp Wire Termination

5.0mm (.197")

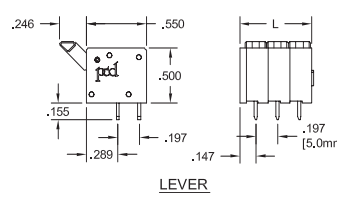
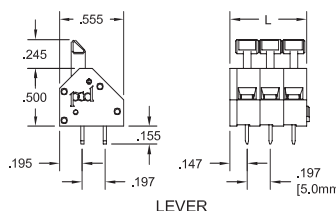
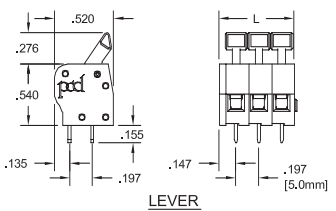
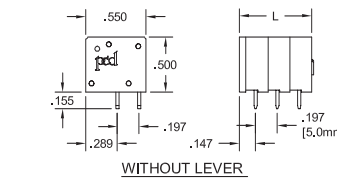
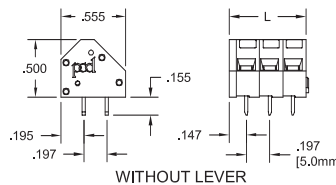
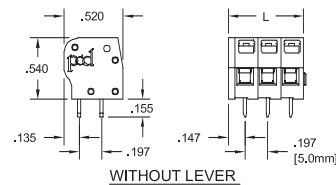
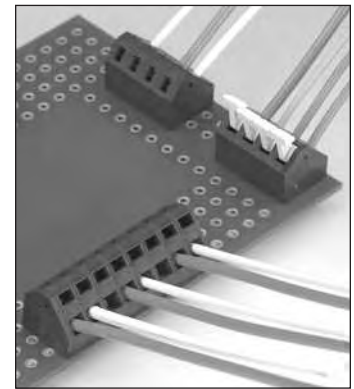
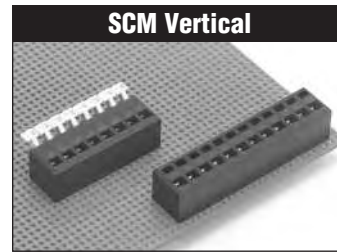
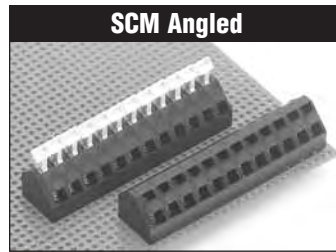

Pos	Catalog # w/o Lever	Catalog # Lever	L (mm)	Pos	Catalog # w/o Lever	Catalog # Lever	L (mm)	Pos	Catalog # w/o Lever	Catalog # Lever	L (mm)
2	SCM021100	SCM021100L	11.5	2	SCM023100	SCM023100L	11.5	2	SCM029100	SCM029100L	11.5
3	SCM031100	SCM031100L	16.5	3	SCM033100	SCM033100L	16.5	3	SCM039100	SCM039100L	16.5
4	SCM041100	SCM041100L	21.5	4	SCM043100	SCM043100L	21.5	4	SCM049100	SCM049100L	21.5
5	SCM051100	SCM051100L	26.5	5	SCM053100	SCM053100L	26.5	5	SCM059100	SCM059100L	26.5
6	SCM061100	SCM061100L	31.5	6	SCM063100	SCM063100L	31.5	6	SCM069100	SCM069100L	31.5
7	SCM071100	SCM071100L	36.5	7	SCM073100	SCM073100L	36.5	7	SCM079100	SCM079100L	36.5
8	SCM081100	SCM081100L	41.5	8	SCM083100	SCM083100L	41.5	8	SCM089100	SCM089100L	41.5
9	SCM091100	SCM091100L	46.5	9	SCM093100	SCM093100L	46.5	9	SCM099100	SCM099100L	46.5
10	SCM101100	SCM101100L	51.5	10	SCM103100	SCM103100L	51.5	10	SCM109100	SCM109100L	51.5
11	SCM111100	SCM111100L	56.5	11	SCM113100	SCM113100L	56.5	11	SCM119100	SCM119100L	56.5
12	SCM121100	SCM121100L	61.5	12	SCM123100	SCM123100L	61.5	12	SCM129100	SCM129100L	61.5
13	SCM131100	SCM131100L	66.5	13	SCM133100	SCM133100L	66.5	13	SCM139100	SCM139100L	66.5
14	SCM141100	SCM141100L	71.5	14	SCM143100	SCM143100L	71.5	14	SCM149100	SCM149100L	71.5
15	SCM151100	SCM151100L	76.5	15	SCM153100	SCM153100L	76.5	15	SCM159100	SCM159100L	76.5
16	SCM161100	SCM161100L	81.5	16	SCM163100	SCM163100L	81.5	16	SCM169100	SCM169100L	81.5
17	SCM171100	SCM171100L	86.5	17	SCM173100	SCM173100L	86.5	17	SCM179100	SCM179100L	86.5
18	SCM181100	SCM181100L	91.5	18	SCM183100	SCM183100L	91.5	18	SCM189100	SCM189100L	91.5
19	SCM191100	SCM191100L	96.5	19	SCM193100	SCM193100L	96.5	19	SCM199100	SCM199100L	96.5
20	SCM201100	SCM201100L	101.5	20	SCM203100	SCM203100L	101.5	20	SCM209100	SCM209100L	101.5

SCM 5.0mm spring clamp terminal blocks are rated at 20A/300V—the highest in the industry—and are supplied in horizontal, angled and vertical configurations.

Two Modes of Operation

Individual spring contact clamps are depressed to insert or remove wires by either actuating a finger lever or inserting a flat-bladed screwdriver in an actuation slot on the block.

SMT Compatibility

The SCM is the only spring clamp terminal block available which is suitable for SMT reflow solder PCB manufacturing processes as well as wave solder; providing users with additional flexibility and maximizing production efficiencies by eliminating secondary solder operations. Blocks are molded of ultra-high-temperature, glass-filled polyamide that will withstand temperatures of 260°C during PCB production.

Variations

Contact Amphenol Pcd for color and marking options.

APPROVALS:



INSTALLATION:

Wire Range: 12-28 AWG
Wire Strip Length: .220"
Hole Diameter: .047 min.

MATERIALS:

Housing/Lever: PA, UL 94V-0, black
Contact: Brass, tin-lead finish
Spring Clamp: Stainless steel

SPECIFICATIONS:

Current Rating: 20A
Operating Voltage: 300V
Insulation Resistance: >10³ Megohms
Dielectric Withstanding: <1600V
Wire Pullout Force:
Per UL 486E, Section 14

Amphenol Pcd

.150" (3.81mm)

SCVF Spring Clamp Plug Connector With and Without Locking Ears

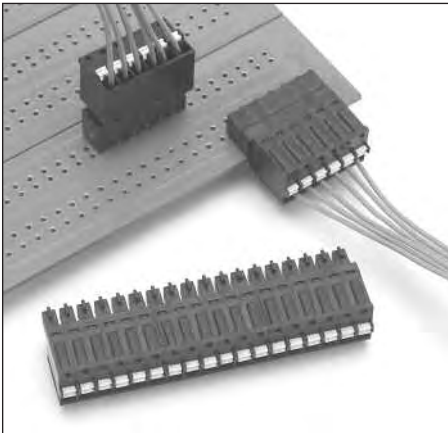

.150" spacing SCVF spring-clamp plugs utilize a stainless steel clamping spring to provide "screwless" wire termination. Convenient "front-front" design permits both wire entry and spring actuation from the same connector surface, simplifying operation.

SCVF plugs mate with the complete range of ELVH headers shown on pages 18, 20 and 22, as well as compatible competitive headers.

Installation

When used with stranded wire, an actuating button is depressed to open the clamp and facilitate wire insertion. Releasing the button captures the wire in a gas-tight, high-pressure contact.

One-hand Installation

If 18 AWG solid wire or larger is used, it is not necessary to operate the actuating button. The wire can be inserted directly into the connector, and will be securely retained by the angled clamp.

Variations

Plugs are available in black or green with tin-lead plating, standard. For gold plating, indicate "1" as eighth digit of catalog no. for black parts; "2" replaces "G" for green parts. Contact Amphenol Pcd to discuss marking options.

APPROVALS:



Amphenol Pcd

SCVF—.150" Pitch



SCVF—.150" Pitch—Eared

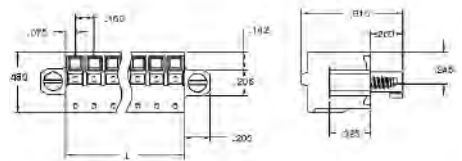

Pos	Catalog # Black	Catalog # Green	L (In.)
2	SCVF02400	SCVF024G0	.300
3	SCVF03400	SCVF034G0	.450
4	SCVF04400	SCVF044G0	.600
5	SCVF05400	SCVF054G0	.750
6	SCVF06400	SCVF064G0	.900
7	SCVF07400	SCVF074G0	1.050
8	SCVF08400	SCVF084G0	1.200
9	SCVF09400	SCVF094G0	1.350
10	SCVF10400	SCVF104G0	1.500
11	SCVF11400	SCVF114G0	1.650
12	SCVF12400	SCVF124G0	1.800
13	SCVF13400	SCVF134G0	1.950
14	SCVF14400	SCVF144G0	2.100
15	SCVF15400	SCVF154G0	2.250
16	SCVF16400	SCVF164G0	2.400
17	SCVF17400	SCVF174G0	2.550
18	SCVF18400	SCVF184G0	2.700
19	SCVF19400	SCVF194G0	2.850
20	SCVF20400	SCVF204G0	3.000

Pos	Catalog # Black	Catalog # Green	L (In.)
2	SCVF02400E	SCVF024G0E	.700
3	SCVF03400E	SCVF034G0E	.850
4	SCVF04400E	SCVF044G0E	1.000
5	SCVF05400E	SCVF054G0E	1.150
6	SCVF06400E	SCVF064G0E	1.300
7	SCVF07400E	SCVF074G0E	1.450
8	SCVF08400E	SCVF084G0E	1.600
9	SCVF09400E	SCVF094G0E	1.750
10	SCVF10400E	SCVF104G0E	1.800
11	SCVF11400E	SCVF114G0E	2.050
12	SCVF12400E	SCVF124G0E	2.200
13	SCVF13400E	SCVF134G0E	2.350
14	SCVF14400E	SCVF144G0E	2.500
15	SCVF15400E	SCVF154G0E	2.650
16	SCVF16400E	SCVF164G0E	2.800
17	SCVF17400E	SCVF174G0E	2.950
18	SCVF18400E	SCVF184G0E	3.100
19	SCVF19400E	SCVF194G0E	3.250
20	SCVF20400E	SCVF204G0E	3.400

SPECIFICATIONS:

Current Rating: 12A
Operating Voltage: 300V
Insulation Resistance: >10⁵ Megohms
Dielectric Withstanding: <3000V
Wire Pullout Force:
Per UL 486E, Section 14

MATERIALS:

Housing: PA 66-6, UL 94V-0, Black or green
Contact: Copper alloy, optional finish
Spring Clamp: Stainless Steel

INSTALLATION:

Wire Range: 16-28 AWG
Wire Strip Length: .330"

SCFF Spring Clamp Plug Connector

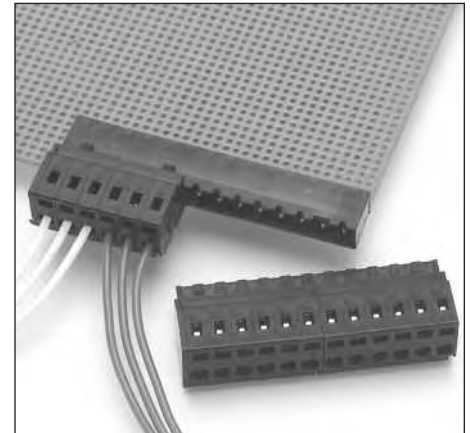

.200" spacing SCFF spring-clamp plugs utilize a stainless steel clamping spring to provide "screwless" wire termination. Convenient "front-front" design permits both wire entry and spring actuation from the same connector surface, simplifying operation.

SCFF plugs mate with the complete range of ELF headers shown on pages 45-46 and 48-49, as well as compatible competitive headers.

Installation

Individual spring contact clamps are depressed to insert or remove wires by a flat-bladed screwdriver in an actuation slot on the block.

Once wire is inserted and the spring released, the stainless steel spring clamp maintains a consistent high pressure, gas tight contact between the soft tin-lead plated block contact and the wire.

Variations

Plugs are available in black or green with tin-lead plating, standard. For gold plating, indicate "1" as the last digit of catalog no. for black parts; "1G" in the last position (in place of "G") for green parts. Contact Amphenol Pcd to discuss marking options.

Pos	Catalog # Black	Catalog # Green	L (In.)
2	SCFF02210	SCFF0221G	.460
3	SCFF03210	SCFF0321G	.660
4	SCFF04210	SCFF0421G	.860
5	SCFF05210	SCFF0521G	1.060
6	SCFF06210	SCFF0621G	1.260
7	SCFF07210	SCFF0721G	1.460
8	SCFF08210	SCFF0821G	1.660

MATERIALS:

Housing: PPO, UL 94V-0, Black or green
Contact: Phosphor bronze, optional finish
Spring Clamp: Stainless Steel

INSTALLATION:

Wire Range: 12-28 AWG
Wire Strip Length: .250"

SPECIFICATIONS:

Current Rating: 15A
Operating Voltage: 300V
Insulation Resistance: >10⁵ Megohms
Dielectric Withstanding: <3000V
Wire Pullout Force:
 Per UL 486E, Section 14

APPROVALS:



Amphenol Pcd

**.100—
.375"**

ELECTROCON Screw-Terminal/Edgecard Connectors

The Electrocon line is a diverse family of rugged, high-reliability screw-terminal/edgecard connectors which combine the discrete wire termination capability of a screw-terminal block with the mass termination convenience of an edgecard connector.

Electrocon connectors are designed specifically for instrumentation and programmable/process controller I/O and other discrete wire-to-board interconnect and input/output applications. The product line and interconnect concepts are particularly suitable for customization into system controller I/O portals, or module interconnects. Numerous applications exist where standard Electrocon concepts have been utilized to develop I/O interconnects tailored to serve as the system user's entry to the system.

Standard Electrocons are available in a broad range and variety of mounting and application configurations, as indicated on the following pages, and in contact spacings ranging from .100" to .375". Depending on configuration, single- and double-sided versions are also available.



Superior Contact Design

A primary performance feature and advantage of the entire Electrocon line is the use of precision-stamped and formed beam contacts—in either single or dual beam configurations—in all connectors.



Based on many years of broad-ranging electronic connector design experience utilizing in-depth solid modeling and stress analysis, beam contacts offer significant advantages—greater stress resistance, reduced board damage, selective gold plating, lower cost—over the blanked tuning fork contacts traditionally used in similar connectors.

Electrocon connectors and contacts are designed to accept a complete board thickness range (.054-.070"), and function under extreme conditions of board warping, bending and motion. The beam contact eliminates board and contact damage possible with tuning fork contacts under similar conditions.

Whenever possible, contacts are preloaded. The pre-load guarantees high normal force and good electrical and mechanical contact with a minimal amount of deflection.

Selective Gold Plating

Stamped and formed contacts also allow Amphenol Pcd to take advantage of the selective plating process and provide a heavy gold plate where it counts—at the contact point. The use of selective plating also provides gold plated contacts for industrial applications at little more than the cost of tin plating.

Special Connectors

In addition to the standard Electrocon connector lines presented on the following pages, Amphenol Pcd is the industry's leading developer and supplier of specialty screw-terminal/edgecard and screw-barrier/edgecard connectors tailored to meet specific customer application requirements. Focused on PLC and similar applications, where the need for special identity and configuration is often paramount, these connectors combine standard elements with unique features designed for the specific application.



Please contact Amphenol Pcd to discuss requirements for unique configurations.

Amphenol Pcd

ELECTROCON ELH Screw-Terminal/Edgecard Connector

.100"

ELH Single-density



ELH Double-density



Highest Contact Density

The ELH .100" spacing, high-density screw-terminal/edgecard connector features the highest contact density of any screw termination connector system available. Connectors are available in single- and double-density versions and range in size from 10-40 and 20-80 contacts, respectively.

The ELH is designed for use with double-sided boards. Single-density connectors provide opposing board contacts on staggered .200" centers. The double-density design features opposing board contacts on .100" centers. (See drawings.)

Bifurcated, selectively-plated contacts are pre-loaded to guarantee high normal force and good electrical and mechanical contact with a minimum of contact deflection. This assures reliable performance under extreme conditions of board warping, thickness and movement.

Connectors are designed for side wire entry. Screw terminations are actuated from the rear of the connector. Single-density wire bundles train to one side (left or right) of the connector. Double-density bundles train to both sides.

Sizes and Special Configurations

Connector sizes listed are standard configurations. Contact Amphenol Pcd for minimum order quantity requirements for special sizes and configurations.

Pos	Catalog #	A	B	C	D	Pos	Catalog #	A	B	C	D
10	ELH101100	1.10	1.26	1.58	1.84	20	ELH102100	1.10	1.26	1.58	1.84
15	ELH151100	1.40	1.56	1.88	2.14	36	ELH182100	1.90	2.06	2.375	2.64
18	ELH181100	1.90	2.06	2.38	2.64	40	ELH202100	2.10	2.26	2.58	2.84
20	ELH201100	2.10	2.26	2.58	2.84	44	ELH222100	2.30	2.46	2.78	3.04
22	ELH221100	2.30	2.46	2.78	3.04	50	ELH252100	2.60	2.76	3.08	3.34
25	ELH251100	2.60	2.76	3.08	3.34	60	ELH302100	3.10	3.26	3.58	3.84
30	ELH301100	3.10	3.26	3.58	3.84	72	ELH362100	3.70	3.86	4.18	4.44
36	ELH361100	3.70	3.86	4.18	4.44	80	ELH402100	4.10	4.26	4.58	4.84
40	ELH401100	4.10	4.26	4.58	4.84						

SPECIFICATIONS:

- Current Rating:** 5A
- Insulation Resistance:** >10⁵ Megohms
- Durability:** 500 cycles per MIL-C-21097
- Wire Range:** 14-26 AWG
- Wire Pullout Force:** 35 lbs minimum
- Board Thickness Range:** .054-.070"

MATERIALS

- Housing:** Glass-filled polyester, UL 94-V0, Black
- Contact:** Phosphor bronze, .000030" selective gold finish
- Wire Clamp:** Brass, nickel finish
- Terminal Screw:** Steel, nickel finish

Amphenol Pcd

.156"

ELECTROCON ELC Screw-Terminal/Edgecard Connector



The compact .156" ELC wire-to-board edgecard terminal block is designed for panel-mounting with bottom wire entry. Connectors are available in single and double-sided configurations to meet specific application needs.

Superior Contact Design

The ELC features a bifurcated cantilever beam contact that eliminates the board damage possible with the stamped tuning fork board contacts commonly used in similar connectors. The cantilever beam also assures improved performance under board warping and bending conditions over the full .054" to .070" board thickness range.

Connectors are available with special marking and configuration adaptations, and in sizes not indicated in the table. Please contact Amphenol Pcd for details.

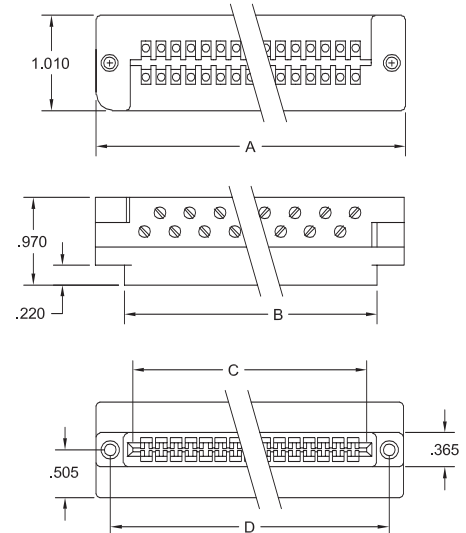
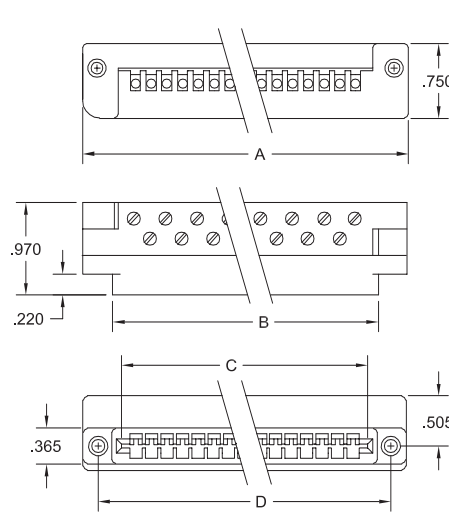

Pos	Catalog #	A	B	C	D	Pos	Catalog #	A	B	C	D
6	ELC062100	1.100	1.252	1.534	1.844	12	ELC101100	1.100	1.252	1.534	1.844
10	ELC102100	1.724	1.876	2.158	2.468	20	ELC181100	1.724	1.876	2.158	2.468
12	ELC122100	2.036	2.188	2.470	2.780	24	ELC201100	2.036	2.188	2.470	2.780
15	ELC152100	2.504	2.656	2.938	3.248	30	ELC221100	2.504	2.656	2.938	3.248
18	ELC182100	2.972	3.124	3.406	3.716	36	ELC251100	2.972	3.124	3.406	3.716
22	ELC222100	3.596	3.748	4.030	4.340	44	ELC301100	3.596	3.748	4.030	4.340

SPECIFICATIONS:

- Current Rating:** 5A
- Insulation Resistance:** >5³ Megohms
- Contact Resistance:** <30mV @ rated current
- Durability:** 500 cycles per MIL-C-21097
- Wire Range:** 14-26 AWG
- Wire Pullout Force:** 35 lbs minimum
- Board Thickness Range:** .054-.070"

MATERIALS

- Housing:** Glass-filled polyester, UL 94-V0, Black
- Contact:** Phosphor bronze, .000030" selective gold finish
- Wire Clamp:** Brass, nickel finish
- Terminal Screw:** Steel, nickel finish

Amphenol Pcd

ELECTROCON ELB Cage-Clamp/Edgecard Connector

.156"

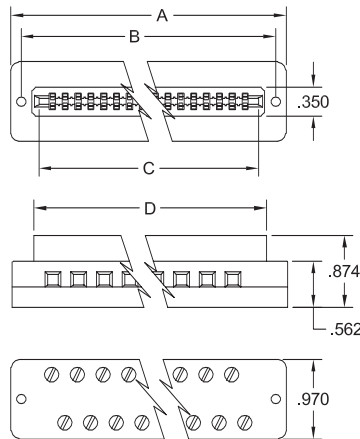

The .156" ELB wire-to-board edgecard terminal block features selectively gold-plated cantilever beam board contacts and a moving cage clamp wire termination.

Wires are installed at right angles to the plane of the board and contact, and alternate top and bottom entry.

Pos	Catalog #	A	B	C	D
6	ELB061100	1.79	1.54	1.10	1.26
8	ELB081100	2.10	1.85	1.41	1.58
10	ELB101100	2.41	2.16	1.72	1.89
12	ELB121100	2.72	2.47	2.04	2.20
15	ELB151100	3.19	2.94	2.50	2.67
16	ELB161100	3.35	3.10	2.66	2.82
18	ELB181100	3.66	3.41	2.97	3.14
22	ELB221100	4.28	4.03	3.60	3.76
24	ELB241100	4.59	4.34	3.91	4.07
28	ELB281100	5.22	4.97	4.53	4.70
30	ELB301100	5.53	5.28	4.84	5.01
32	ELB321100	5.84	5.59	5.16	5.32
36	ELB361100	6.47	6.22	5.78	5.94
43	ELB431100	7.56	7.31	6.87	7.04

SPECIFICATIONS:

Current Rating: 10A
Insulation Resistance: >10⁵ Megohms
Wire Range: 14-26 AWG
Wire Pullout Force: Per UL 486
Board Thickness Range: .054-.070"

APPROVALS:



Superior Contact Design

Key to the superior performance of the ELB is a unique cantilever beam contact that eliminates the board damage possible with the stamped tuning fork board contacts commonly used in similar connectors. The dual cantilever beam also assures improved performance under board warping and bending conditions over the full .054" to .070" board thickness range.

Moving cage clamp contacts provide direct, high pressure wire termination without strand damage.

Connectors are available with special marking and configuration adaptations, and in sizes not indicated in the table. Please contact Amphenol Pcd for details.

MATERIALS

Housing: Glass-filled polyester, UL 94-V0, Black
Contact: Phosphor bronze, .000030" selective gold finish
Wire Clamp: Brass, nickel finish
Terminal Screw: Steel, nickel finish

Amphenol Pcd

.200"

ELECTROCON ELD Cage-Clamp/Edgecard Connector



The .200" ELD wire-to-board edgecard terminal block features selectively gold-plated cantilever beam board contacts and a moving cage clamp wire termination.

Wires are installed in line with the plane of the board and contact, and can be trained in any direction.

Superior Contact Design

Key to the superior performance of the ELD is a unique cantilever beam contact that eliminates the board damage possible with the stamped tuning fork board contacts commonly used in similar connectors. The dual cantilever beam also assures improved performance under board warping and bending conditions over the full .054" to .070" board thickness range.

Moving cage clamp contacts provide direct, high pressure wire termination without strand damage.

Connectors are available with special marking and configuration adaptations, and in sizes not indicated in the table. Please contact Amphenol Pcd for details.



Pos	Catalog #	A	B	C	D
6	ELD061100	2.15	1.80	1.12	1.40
8	ELD081100	2.55	2.20	1.52	1.80
10	ELD101100	2.95	2.60	1.92	2.20
12	ELD121100	3.35	3.00	2.32	2.60
15	ELD151100	3.95	3.60	2.92	3.20
16	ELD161100	4.15	3.80	3.12	3.40
18	ELD181100	4.55	4.20	3.52	3.80
20	ELD201100	4.95	4.60	3.92	4.20
22	ELD221100	5.35	5.00	4.32	4.60
24	ELD241100	5.75	5.40	4.72	5.00
30	ELD301100	6.95	6.60	5.92	6.20
32	ELD321100	7.35	7.00	6.32	6.60
34	ELD341100	7.75	7.40	6.72	7.00
36	ELD361100	8.15	7.80	7.12	7.40

MATERIALS

Housing: Glass-filled polyester, UL 94-V0, Black

Contact: Phosphor bronze, .000030" selective gold finish

Wire Clamp: Brass, nickel finish

Terminal Screw: Steel, nickel finish

SPECIFICATIONS:

Current Rating: 10A

Insulation Resistance: >10⁵ Megohms

Wire Range: 14-26 AWG

Wire Pullout Force: Per UL 486

Board Thickness Range: .054-.070"

APPROVALS:

Amphenol Pcd



ELECTROCON ELE Screw-Barrier/Edgecard Connector

.375"



Pos	Catalog #	A	B	C	D
2	ELE022110	.50	.66	1.125	1.50
4	ELE042110	1.25	1.41	1.875	2.25
6	ELE062110	2.00	2.16	2.625	3.00
8	ELE082110	2.75	2.91	3.375	3.75
10	ELE102110	3.50	3.66	4.125	4.50
12	ELE122110	4.25	4.41	4.875	5.25
16	ELE162110	5.75	5.91	6.375	6.75
18	ELE182110	6.50	6.66	7.125	7.50
20	ELE202110	7.25	7.41	7.875	8.25
24	ELE242110	8.75	8.91	9.375	9.75
28	ELE282110	10.25	10.41	10.875	11.25

SPECIFICATIONS:

Current Rating: 10A
Insulation Resistance: >10⁵ Megohms
Wire Range: 12-22 AWG
Wire Pullout Force: Per UL 486
Board Thickness Range: .054-.070"

The rugged .375" ELE wire-to-board screw-barrier terminal block offers gang disconnect capability in a popular screw clamp-style terminal block configuration.

Selectively gold-plated, bifurcated cantilever beam contacts eliminate the board damage possible with the stamped tuning fork contacts commonly utilized in this application.

Additionally, the ELE assures a high reliability wire termination through use of a #6-32 SEM nickel-plated steel screw and clamp, retained by a separate steel nut. This design overcomes the thread stripping problems inherent in blocks that thread the thin contact material to retain the clamping screw.

Connectors are available with special marking and configuration adaptations, and in sizes not indicated in the table. Please contact Amphenol Pcd for details.

APPROVALS:



MATERIALS

Housing: Phenylene oxide, black, UL 94-V0
Contact: Phosphor bronze, .000030" selective gold finish
Terminal Screw: Steel, nickel finish

Amphenol Pcd

.375"

ELECTROCON ELI Screw-Barrier/Edgecard with Cover



The .375" spacing ELI screw-barrier/edgecard connector features pre-loaded, selectively gold-plated cantilever beam contacts.

The pre-loaded contact will consistently and dependably exert a high normal force and reliable connection over a high range of board thicknesses and warping conditions, while the cantilever beam design eliminates board wear encountered with tuning fork contact designs.

A steel #6-32 screw and separate steel nut provide high reliability wire termination.

The ELI also features integral mounting hardware and a swiveling snap-down, screw-terminal cover that provides insulation, protection and ease of marking.

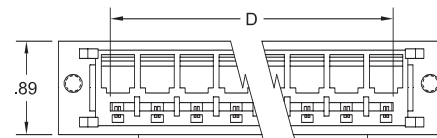
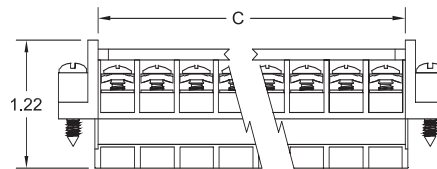
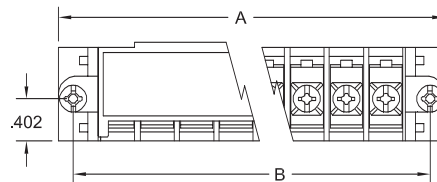

Pos	Catalog #	A	B	C	D
2	ELI020100	1.50	1.218	.750	.510
3	ELI030100	1.87	1.593	1.125	.885
4	ELI040100	2.25	1.968	1.500	1.260
5	ELI050100	2.62	2.343	1.875	1.635
6	ELI106100	3.00	2.718	2.250	2.010
7	ELI107100	3.37	3.093	2.625	2.385
8	ELI080100	3.75	3.468	3.000	2.760
10	ELI100100	4.50	4.218	3.750	3.510
12	ELI120100	5.25	4.968	4.500	4.260
15	ELI150100	6.37	6.093	5.625	5.385
18	ELI180100	7.50	7.218	6.750	6.510

APPROVALS:



MATERIALS

Housing: Glass-filled polyester, UL 94-V0, Black

Contact: Phosphor bronze, .000030" selective gold finish

Terminal Screw: Steel, nickel finish

SPECIFICATIONS:

Current Rating: 10A

Insulation Resistance: >10⁵ Megohms

Wire Range: 12-22 AWG

Wire Pullout Force: Per UL 486

Minimum Torque Withstanding: 12 lb-in.

Board Thickness Range: .054-.070"

Amphenol Pcd

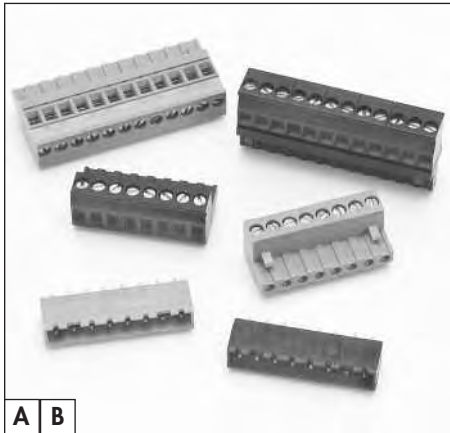

A B

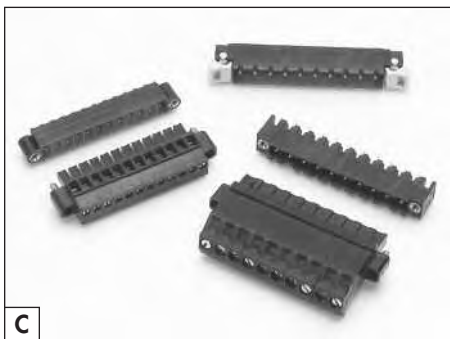

C



D

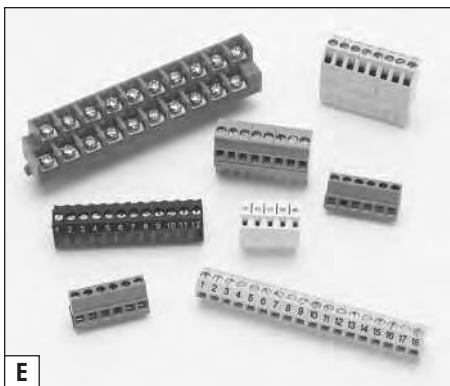

E

Since industrial terminal blocks are frequently used for control and equipment I/O purposes, it is particularly important to many equipment manufacturers to provide their end users with I/O terminal blocks tailored to their specific application and performance criteria, or with a distinctive appearance.

Amphenol Pcd is dedicated to responding to unique customer needs for tailored or custom blocks more rapidly than any other supplier. Additionally, rapid delivery on a broad range of both standard products and standard options provides the capability to customize even smaller projects without delay or expense.

STANDARD OPTIONS

- A. Color: Most blocks and connectors are available in green or black.
- B. Plating: Tin-lead or gold
- C. Mounting: Optional plug and header mounting, locking and ejector ears.
- D. Marking: Three standard marking options for plugs and headers.

MINOR MODIFICATIONS

Typical of the minor connector or terminal block modifications made to meet specific application needs.

- E. Custom colors for error-proof mating.
- F. Custom mounting ears for high vibration or cable stress applications
- G. Special tails for multi-layer boards.
- H. Custom marking for clearer ID.
- I. Dealer packaging: Terminal block, accessories, information, packaged in customer box for direct resale by customer dealer.



F



G



H



I



MAJOR MODIFICATIONS

A. Custom I/O mounting enclosure accepts a variety of standard Amphenol Pcd terminal blocks and provides wire trough, clear plastic cover, wiring designations and customer corporate identity. Custom connector colors provide distinctive appearance and allow user to offer different termination alternates in line with customer or local wiring practices and codes.

B. Headers incorporate selectively recessed contacts for make first/break last mating.

C. ELFH headers with extra long tails, integrally molded standoffs and board retention clips for stability during the soldering process.

D. Wire-to-board terminal blocks feature custom mounting ears to provide a secure screw-down mechanical connection to the board for severe stress conditions. Special marking.



E. 3-tier .150" spacing wire-to-board block configured as high density I/O interconnect. Custom marking.

F. Finger-guard screw termination covers provide electrical protection.

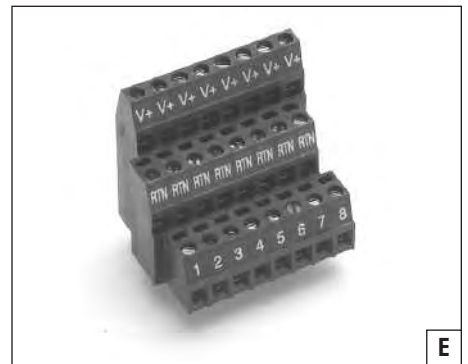
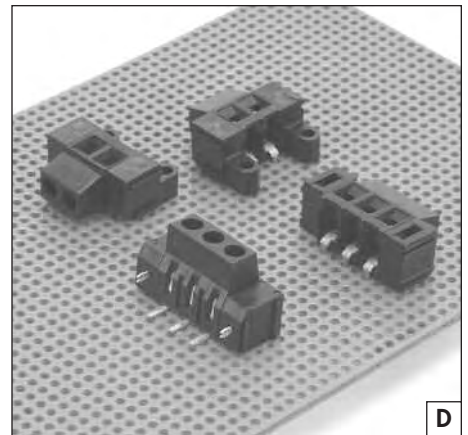
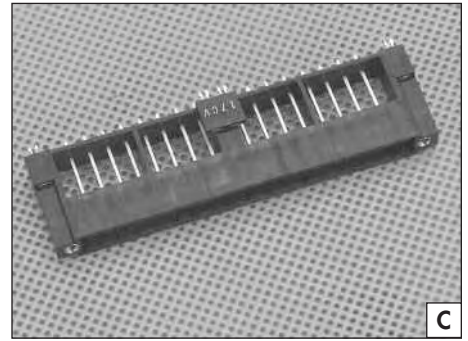

Options/Modifications and Custom Interconnect Systems

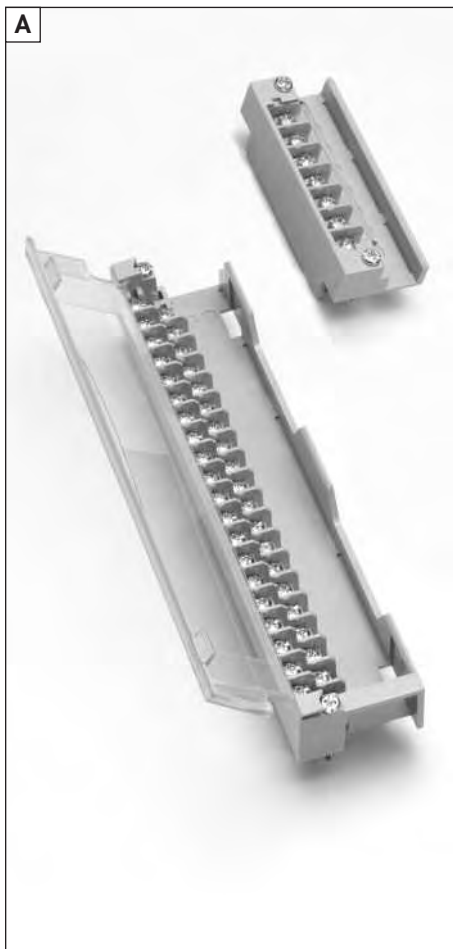

NEW SYSTEMS AND APPLICATION-SPECIFIC CONNECTORS

A. 7- and 40-position edgecard I/O terminal blocks, developed to customer requirements, provide custom package configurations, custom keying, color and hot-swap capability.

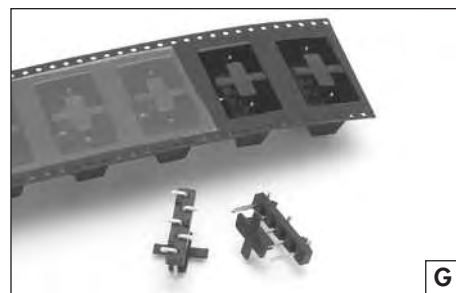
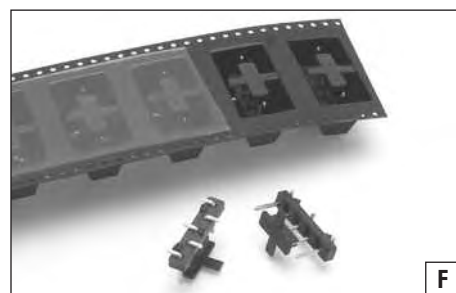
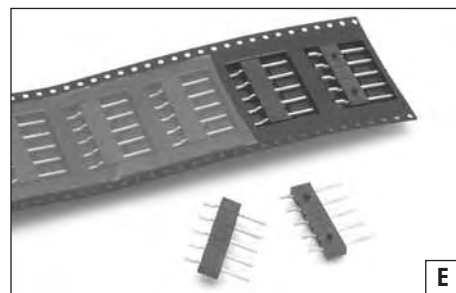
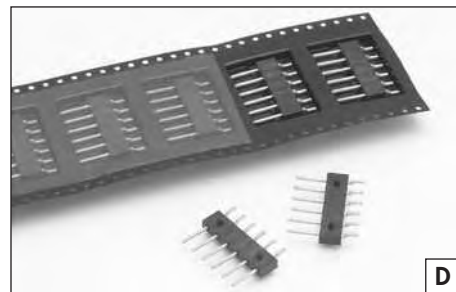
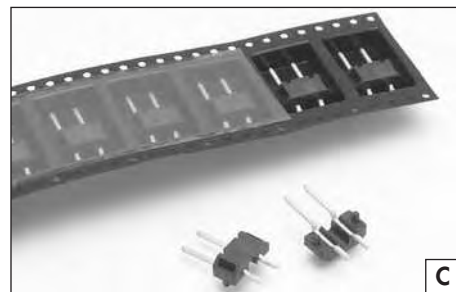

C—G. Custom surface mount headers designed for pick-and-place equipment utilize tape-and-reel packaging to facilitate auto-assembly. Headers are provided in a range of sizes and configurations.

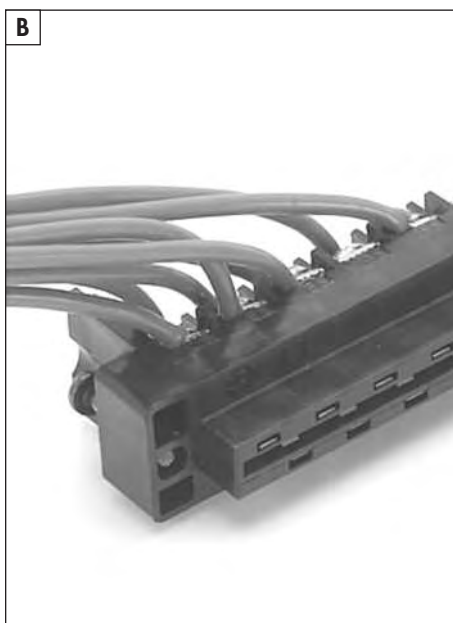

B. 30-position edgecard I/O terminal block features internally pre-loaded contact and jack-screw mating

FIELD EQUIPMENT INTERCONNECTIONS

Interface modules are industrial interconnect devices which expand traditional terminal block I/O functions by incorporating the blocks, high-density electronic connectors, and often additional electronic components into a rail-mounted printed board assembly.

The modules simplify interconnections between system I/O cards and field equipment while reducing installed cost and upgrading installation reliability. They are available in standard configurations, or can be readily built-to-order by Amphenol Pcd to customer requirements.

Basic Construction

The interface module consists of four key elements:

- 1) A standard board-mount terminal block, similar to those presented on pages 10–70 of this catalog, which serves as the termination for discrete control wires emanating from operating equipment. Depending on the application, blocks may be one-piece or separable plugs and headers.
- 2) An multiple pin electronic connector—D-Sub, ribbon cable, RJ style, Centronic or DIN—which links the module to the controller, drive or other host device. In some applications a relay serves as the controller, and plugs directly into a socket integral to the module.
- 3) Electronic components—typically diodes, LEDs, resistors or capacitors—which perform signal modification and monitoring functions may be included.
- 4) The structural platform, consisting of a multi-layer printed circuit board that includes all circuitry, to which the components are precision soldered, and a mounting system which houses the board and secures to a standard DIN track. Alternate mounting systems are available.



Advantages and Benefits

By replacing discrete terminations with a single pluggable connection, and providing an alternate to DIN style terminal blocks in many applications, custom and standard interface modules offer users a variety of benefits.

- Reduced wiring time
- Reduced wiring errors
- Faster troubleshooting and easier maintenance
- Increased volume and productivity
- Reduced wire preparation and routing.
- Simplified panel layout
- Reduced space needs
- Fewer parts, lower inventory

Custom Modules

Amphenol Pcd welcomes the opportunity to coordinate with customers in developing and supplying customized interface modules tailored to specific applications. Since Amphenol Pcd supplies the bulk of the terminal blocks utilized as a key module element, prompt delivery and economical cost are assured.

Modules can be built entirely to customer specifications, or based on Amphenol Pcd engineering input and recommendations on mechanical or electronic design requirements.

Standard delivery, including review of customer requirements and an Amphenol Pcd proposal, is six weeks from inquiry time, assuming no customer delay in proposal review. In emergencies, Amphenol Pcd has demonstrated the ability to turn around and deliver customized interface modules in less than two weeks.

INTERFACE MODULES

D-Sub and Ribbon Cable Termination

Interface Modules



IDS D-SUB MODULE

IDS Interface Modules feature high-density D-Sub connectors in 9 through 50 positions and fixed or pluggable terminals. The D-Sub connectors are compatible with desktop and laptop I/O ports, and these modules are frequently utilized to facilitate communications between laptops and factory automation equipment for equipment programming purposes. Cable assemblies can be supplied as part of a complete package.

Signal Testing Application

In this application, a customized D-Sub interface module with spring-clamp wire terminations can be quickly mounted in-line with equipment for signal testing purposes. Test probe provisions on the spring-clamp terminations facilitate signal "tapping".

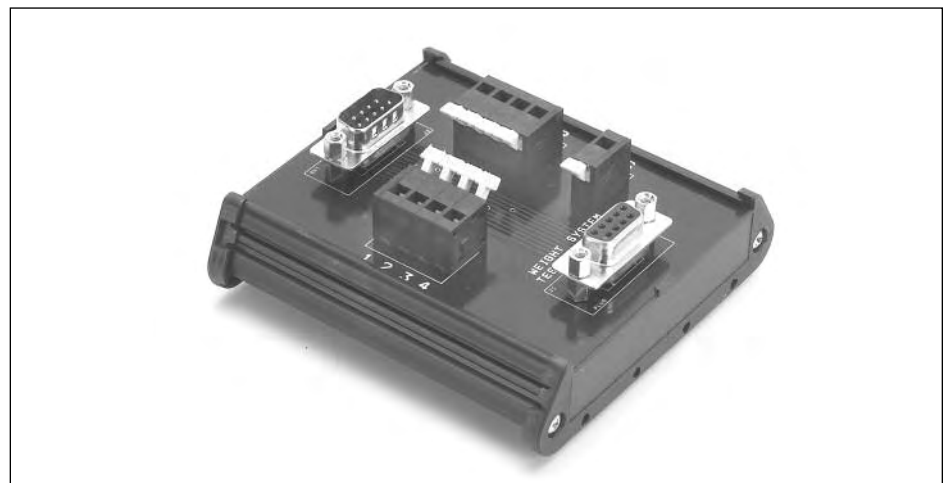

IRC RIBBON CABLE MODULE

Ribbon cable connector interface modules are available in 10 through 64 positions with fixed or pluggable terminals.

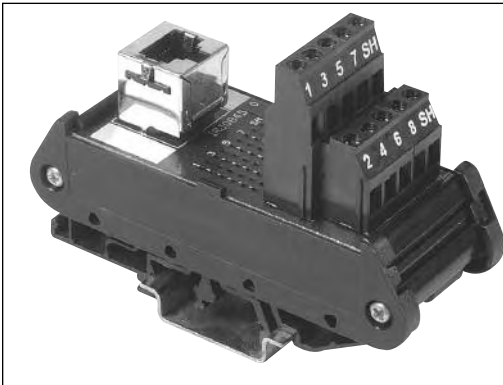

IRJ Ordering Information



IRJ MODULAR JACK

IRJ modular jacks facilitate the increasingly popular use of CAT5 cable in low-cost networking systems. The rail-mounted modules provide one or more RJ-11 or RJ-45 connections, necessary screw or spring clamp terminations, and other components as specified by the user.

IDN DIN CONNECTOR

IDN modules with DIN connector interfaces provide for the highest available interface module I/O density, with as many as 96 contacts available.

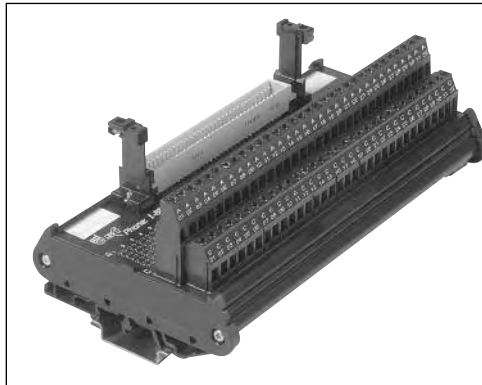

IDN Ordering Information



IRL Ordering Information

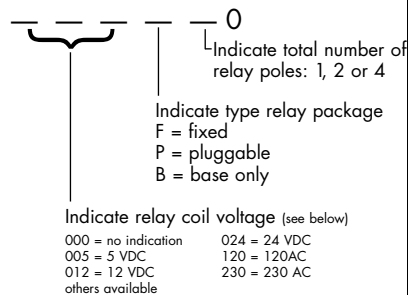

IRL RELAY MODULE

IRL modules house a broad range of industrial style relays in both solid state and electromechanical forms, with 1, 2, and 4 pole configurations. Options include inductive kick-back protection and LED indication. These modules provide remote switching capability for host equipment.

ICN CENTRONICS MODULE

ICN modules provide a high-density interface option in a popular Centronics connector format. Typically used in parallel (36 pin) and SCSI (50 pin) interface applications.

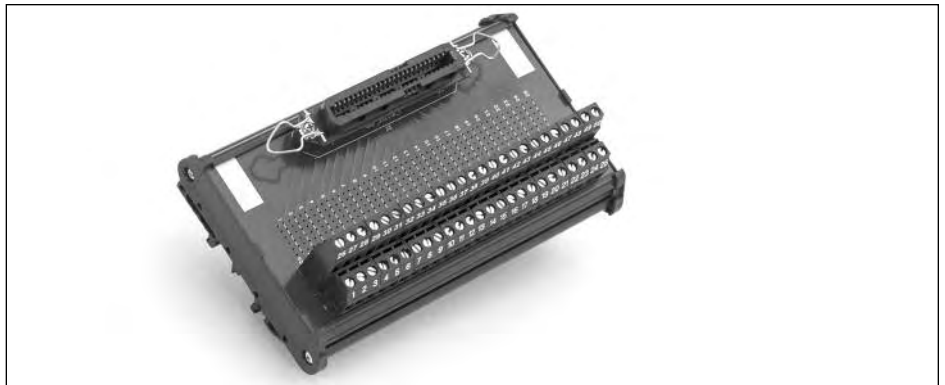

FIELD SIMULATOR BOARDS

These boards are designed to simulate the I/Os that an equipment controller will see, and are utilized in field applications—prior to permanently connecting to the system—to program and check out the controller. Boards plug directly into the controller, and are set to simulate the field system by setting circuit switches on the board.



FUSING MODULE

The fusing module provides in-line fusing and blown fuse indication for every circuit in a distributed I/O system. A pre-wired plug harness is supplied as an integral element of the module, and plugs directly into the system.



INTEGRATED CHASSIS WIRING SYSTEM

Amphenol Pcd worked with this navigation systems supplier to develop a series of five daughter boards and one mother board, installed within the constraints of the existing equipment chassis, which replaced hundreds of discrete wires and internal connections with ribbon cable, and reduced a forty-hour wiring and inspection job to less than six hours. The development entailed engineering visits and constant engineer-to-engineer communication between Amphenol Pcd and customer, and the preparation and electronic interchange of Pro/ENGINEER solid models to review concepts and, ultimately, fits and interferences.

BREAKOUT BOARD ASSEMBLY RESALE PACKAGE

Custom designed 2-tier headers accommodate discrete control and monitoring field wiring. A D-Sub provides interconnection to the controller. This interface module is supplied as a boxed and packaged kit, complete with the D-Sub cable assembly, customer logo identification and labels, sales-channel-ready for resale by the customer's dealers and systems integrators.

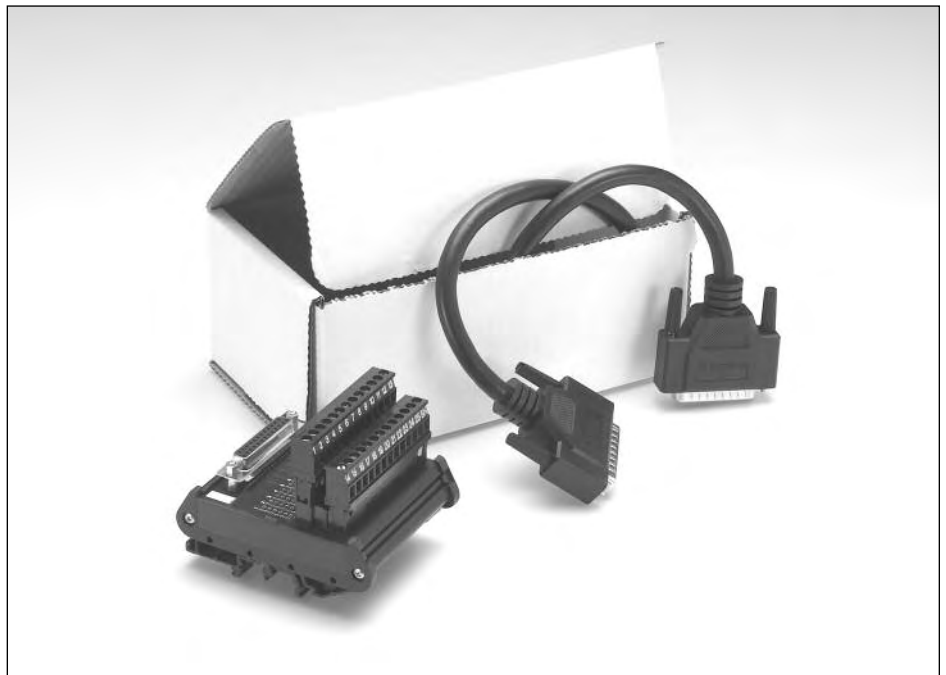

Customized Cable Assemblies

ONE SOURCE SOLUTION

Custom and standard cable assemblies, which interconnect interface modules with host devices, are available from Amphenol Pcd with the module, providing a single source for the total IM solution. Cables can also be ordered separately, or supplied with modules as fully packaged dealer kits on a turnkey basis.

Standard color choices for all cable assemblies are black, gray and beige. Contact Amphenol Pcd to discuss other choices.



STANDARD CABLE ASSEMBLY

Standard cable assemblies are available with any combination of male or female connectors and shielding options.



ONE-SIDE CUSTOM CABLE ASSEMBLY

Cable assemblies available with standard connector on one end and a custom configuration on the other. Options include plug assembly (shown), alligator clips for test points, or custom overmolded connectors.

FULLY CUSTOMIZED CABLE ASSEMBLY

Fully customized cable assemblies available per customer request. Any color and connector combination can be created. See the design specification sheet at the end of this section for information required.

This typical custom cable assembly, developed for testing and temporary applications, features an overmolded pluggable terminal block and clamp-on alligator clips.





The basic WMS12 unit is supplied in 12" lengths, with symmetrical mounting track and a total of eight 4-position I/O terminal blocks. Other lengths and configurations can be supplied. Please contact Amphenol Pcd for specific equipment details and engineering assistance in developing a system best suited for your application.

The Wire Management System reduces wiring labor and costs, and virtually eliminates the long wire runs in typical "picture frame" ducting. It provides a clean assembly, enhances reliability and system expansion, facilitates changes, and permits room for expansion.

Amphenol Pcd's new WMS Wire Management System combines DIN rail, wiring duct, power sources, PC boards and circuitry, I/O capability and DIN terminal block and accessory mounting capability in a compact package.

The WMS System is mounted on an extruded, high performance plastic platform in the shape of an open trapezoid (see photos), which snaps into a plastic bottom plate. The platform supports a standard DIN mounting rail spine (symmetrical and asymmetrical styles are available) and two 4-circuit PC bus boards which run the length of the platform, on either side of the platform, and can be used for power or signal, providing a total of eight bus circuits. 4-position terminal blocks at regular intervals along the bus provide ready wiring access.

In practice, power supplies and system-related DIN terminal blocks are mounted on the DIN rail, and connected to external equipment through the bus board terminal blocks or directly. Multiple power sources



(110V AC, 24V AC, 24V DC) can be mounted along both sides of the WMS, at the point of use. The bus boards and short runs eliminate wiring maze, and all wiring can be run in the duct under the DIN rail formed by the WMS extrusion, saving 30% to 60% of usable space.

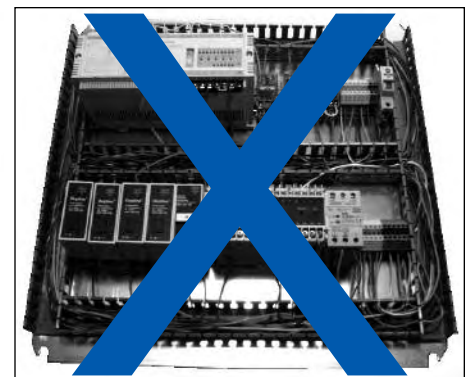

Eliminate excessive and cumbersome wiring.

DIN TERMINAL BLOCKS

Modular, Rail-Mount Interconnect System

**DIN-Rail
System**

DIN RAIL MOUNT INTERCONNECT SYSTEM

The Amphenol Pcd DIN rail-mount interconnect system consists of a broad range of feed-through, ground, double, switching, LED indicator, and fused terminal blocks, plus mounting rail. Modular DIN terminal blocks are available in a wide variety of sizes and specific configurations, and feature both screw-clamp and spring-clamp terminations. Blocks can be mixed and matched on standard DIN rail, and mounted with interface modules and other components to provide a complete connection system.

Related accessories include a full line of spacers, end clamps, end covers and bussing strips. A wide variety of marking options make the package convenient for customer use.

TERMINAL BLOCK FEATURES

Amphenol Pcd blocks provide the system designer with a rugged, compact, extremely flexible and well-designed interconnect family. Almost all blocks feature a multi-foot design, which permits mounting to any of the standard rails. This eliminates problems with mixed rails and blocks, simplifies system design, and reduces inventory.

Further user-oriented features include wide cable entry and funnel shaped guides which ensure that all wire strands enter the clamps, improved thread design to withstand over-torquing, bussing provisions and captive screws. Blocks are supplied ready to wire, with captive screws backed out.

BLOCK ASSEMBLIES

Modular blocks and accessories can be supplied separately, or as pre-assembled custom units, rail-mounted and marked to specification. Contact Amphenol Pcd to review your requirements

MATERIAL

DIN terminal blocks are molded of high strength, flexible Polyamide 6.6 thermoplastic. This material features an operating range of -30° C to 100° C and has a long history of successful field application. High Current bus Bar type blocks (pages 130-131) are molded of high grade Melamine.

Screw clamp terminal bodies and screws are fabricated of hardened steel. The current bar is tin plated copper or high quality brass. Spring clamp terminal blocks incorporate a corrosion-resistant steel tension clamp to press the conductor against a tin plated copper current bar.

ELECTRICAL APPROVALS

All Amphenol Pcd DIN terminal blocks have been designed to conform to the international technical specification IEC947-7-1. UL recognition is under File No. 1059 and CSA approval File 22-2, No. 158.

In addition, the blocks also conform to other European and international standards such as DEMKO, NEMKO and KEMA. Contact Amphenol Pcd for details.

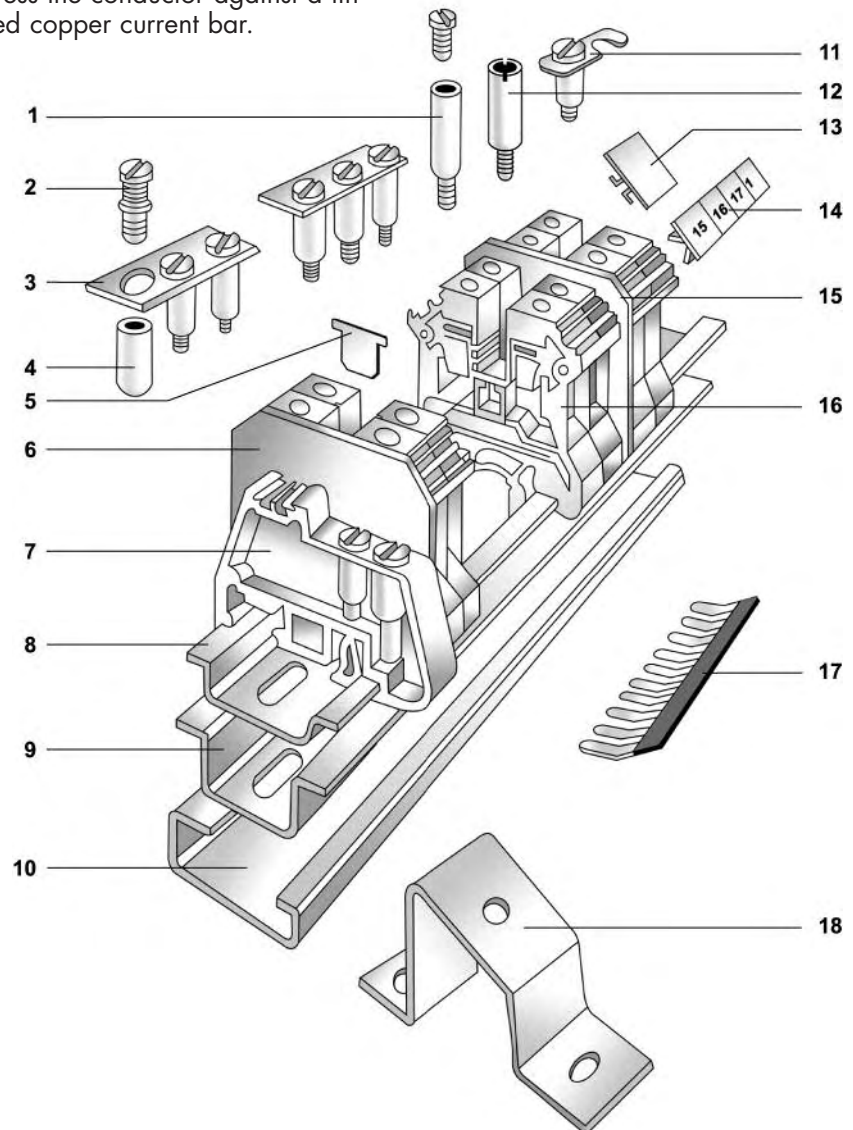

Amphenol Pcd

FEED-THROUGH TERMINAL BLOCKS

Feed-through terminal blocks are available in nine sizes covering the wire range AWG24 - 4/0.

Universal mounting provisions allow the blocks to be utilized with all three standard mounting rails indicated in the accompanying table. A protective well in the center of the block provides access to a tapped hole in the current bar, facilitating bus bar or test socket connections.

Electrical characteristics and ratings, as well as recommendations covering the broad range of accessories utilized with these blocks, are also indicated in the accompanying tables.

Insulation Material:
Polyamide

**Accessory and Marking
Details:** Pages 132-135

Standard Color: Gray

Alternate colors available as indicated below:

COLOR	SUFFIX
Beige	BG
Brown	BR
Blue	BU
Black	BK
Orange	F
Green	G
Red	R
White	W
Yellow	Y



		ATB2	ATB4
Specifications			
Pitch		5 mm	6 mm
Height x Width		45 x 43 mm	45 x 43 mm
Wire Range UL		24-14 AWG	22-10 AWG
Strip Length		9 mm	9 mm
Ratings			
Rated Cross Section		22-12 AWG 0.5-2.5 sq.mm 24-14 AWG	22-10 AWG 0.5-4 sq.mm 22-10 AWG
Voltage Rating		600 V 800 V 600 V	600 V 800 V 600 V
Current Rating		25 A 24 A 20 A	35 A * 32 A 40 A *
Torque		7 lb-in 0.4 Nm 7 lb-in	7 lb-in 0.5 Nm 7 lb-in
Accessories			
INSULATION			
End Plate			ATB2EP
Partition Plate			ATB2PP
Separator Plate			ATB2SP
MOUNTING			
Mounting Rail (std. rail is 1.0 meters pre-slotted)			ATBDR321 ATBDR351 ATBDR35151
End Stop			ATB2EC1
INTERCONNECTION			
Pre Assembled Shorting Links	2 pole 3 pole 10 pole	ATB2SL12 ATB2SL13 ATB2SL110	ATB4SL12 ATB4SL13 ATB4SL110
Insulated Pre Assembled Shorting Links	2 pole 3 pole 10 pole	ATB2SL22 ATB2SL23 ATB2SL210	ATB4SL22 ATB4SL23 ATB4SL210
Insulated Comb Type Shorting Link	2 pole 3 pole 10 pole	ATB2CL12 ATB2CL13 ATB2CL110	ATB4CL12 ATB4CL13 ATB4CL110
Test Socket			ATB2TS
Marking			
Marking Tags	K Type	ATB2MT1	ATB4MT1

* 40 A with 2 Nos of 12 AWG wire; 35 A with 1 No of 10 AWG wire.

Feed-Through Terminal Blocks









ATB6			ATB10			ATB16			ATB25		
											
8 mm			10 mm			12 mm			12 mm		
47 x 43 mm			47 x 43 mm			47 x 43 mm			56 x 49 mm		
22-8 AWG			20-6 AWG			20-4 AWG			14-2 AWG		
12 mm			12 mm			16 mm			18 mm		
											
22-8 AWG	1.5-6 sq.mm	22-8 AWG	22-6 AWG	1.5-10 sq.mm	20-6 AWG	22-6 AWG	2.5-16 sq.mm	20-4 AWG	12-2 AWG	6-25 sq.mm	14-2 AWG
600 V	800 V	600 V	600 V	800 V	600 V	600 V	800 V	600 V	600 V	800 V	600 V
50 A	41 A	50 A	65 A	57 A	65 A	70 A	76 A	85 A	115 A	101 A	115 A
9 lb-in	0.8 Nm	14 lb-in	14 lb-in	1.2 Nm	14 lb-in	14 lb-in	2.0 Nm	14 lb-in	14 lb-in	2.0 Nm	14 lb-in
ATB6EP									ATB25EP		
ATB6PP									ATB25PP		
ATB6SP						ATB16SP					
						ATBDR321 ATBDR351 ATBDR35151					
						ATB2EC1					
ATB6SL12 ATB6SL13 ATB6SL110			ATB10SL12 ATB10SL13 ATB10SL110			ATB16SL12 ATB16SL13 ATB16SL110			ATB25SL12 ATB25SL13 ATB25SL110		
ATB6SL22 ATB6SL23 ATB6SL210			ATB10SL22 ATB10SL23 ATB10SL210			ATB16SL22 ATB16SL23 ATB16SL210			ATB25SL22 ATB25SL23 ATB25SL210		
ATB6CL12 ATB6CL13 ATB6CL110			ATB10CL12 ATB10CL13 ATB10CL110								
			ATB6TS						ATB25TS		
ATB6MT1			ATB10MT1			ATB16MT1			ATB25MT1		

ATB35	ATB50	ATB95
		
	Protected Body	

















Specifications

Pitch	15 mm	20.5 mm	25 mm
Height x Width	58 x 52.5 mm	75.5 x 71 mm	90 x 83 mm
Wire Range UL	8-2 AWG	6-2/0 AWG	2-4/0 AWG
Strip Length	18 mm	22 mm	24 mm

Ratings

									
Rated Cross Section	8-2 AWG	10-35 sq.mm	8-2 AWG	6-2/0 AWG	16-50 sq.mm	6-2/0 AWG	2-4/0 AWG	16-95 sq.mm	2-4/0 AWG
Voltage Rating	600 V	800 V	600 V	600 V	1000 V	600 V	600 V	1000 V	600 V
Current Rating	145 A	125 A	145 A	150 A	150 A	150 A	230 A	232 A	230 A
Torque	25 lb-in	2.5 Nm	25 lb-in	60 lb-in	6.8 Nm	60 lb-in	160 lb-in	18.2 Nm	160 lb-in

Accessories

INSULATION				
End Plate		ATB35EP		
Partition Plate		ATB35PP		
Separator Plate				
MOUNTING				
Mounting Rail (std. rail is 1.0 meters pre-slotted)			ATBDR321 ATBDR351 ATBDR35151	
End Stop			ATB2EC1	
INTERCONNECTION				
Pre Assembled Shorting Links	2 pole 	ATB35SL12		
	3 pole 	ATB35SL13		
	10 pole 	ATB35SL110		
Insulated Pre Assembled Shorting Links	2 pole 	ATB35SL22		
	3 pole 	ATB35SL23		
	10 pole 	ATB35SL210		
Insulated Comb Type Shorting Link	2 pole 			
	3 pole 			
	10 pole 			
Test Socket		ATB25TS		
Marking				
Marking Tags	K Type 	ATB35MT1		

Multiple Connection Terminal Blocks

MULTIPLE CONNECTION TERMINAL BLOCKS

Multiple connection blocks enhance system density and flexibility by providing three or four bussed terminations in a feed-through configuration, plus block-to-block bridging capabilities.

Universal mounting provisions allow the blocks to be utilized with all three standard mounting rails indicated in the accompanying table. A protective well in the center of the block provides access to a tapped hole in the current bar, facilitating bus bar or test socket connections.

Note: Comb links can only be used with upper level terminations.

Electrical characteristics and ratings, as well as recommendations covering the broad range of accessories utilized with these blocks, are also indicated in the accompanying tables.

Insulation Material:
Polyamide















Accessory and Marking Details: Pages 132-135

Standard Color: Gray

Alternate colors available as indicated below:

COLOR	SUFFIX
Blue	BU
Black	BK
Red	R
Yellow	Y

ATM41	ATM42
	
Three bussed screw clamps	Four bussed screw clamps

Specifications						
Pitch	6 mm		6 mm			
Height x Width	47 x 46.5 mm		51.5 x 65 mm			
Wire Range UL	22-10 AWG		22-10 AWG			
Strip Length	9 mm		9 mm			
Ratings						
						
Rated Cross Section	22-10 AWG	0.5-4 sq.mm	22-10 AWG	22-10 AWG	0.5-4 sq.mm	22-10 AWG
Voltage Rating	600 V	630 V	600 V	600 V	630 V	600 V
Current Rating	35 A	32 A	35 A	35 A	32 A	35 A
Torque	7 lb-in	0.5 Nm	7 lb-in	7 lb-in	0.5 Nm	7 lb-in
Accessories						
INSULATION						
End Plate		ATM41EP		ATM42EP		
Separator Plate						
MOUNTING						
Mounting Rail (std. rail is 1.0 meters pre-slotted)				ATBDR321 ATBDR351 ATBDR35151		
End Stop		ATB2EC1				
INTERCONNECTION						
Pre Assembled Shorting Links	2 pole 3 pole 10 pole		ATB4SL12 ATB4SL13 ATB4SL110			
Insulated Pre Assembled Shorting Links	2 pole 3 pole 10 pole		ATB4SL22 ATB4SL23 ATB4SL210			
Insulated Comb Type Shorting Link	2 pole 3 pole 10 pole		ATB4CL12 ATB4CL13 ATB4CL110			
Test Socket		ATB2TS				
Marking						
Marking Tags	K Type		ATB4MT1			

DOUBLE LEVEL FEED-THROUGH BLOCKS

Double level blocks double system density, and are available with two individual circuits, or with internally bussed circuits. When used in conjunction with shorting links at the lower level, these blocks are ideal for distribution applications.

Universal mounting provisions allow the blocks to be utilized with all three standard mounting rails indicated in the accompanying table. Tapped holes in the current bar, facilitating bus bar or test socket connections.

Electrical characteristics and ratings, as well as recommendations covering the broad range of accessories utilized with these blocks, are also indicated in the accompanying tables.



Insulation Material:
Polyamide





















Accessory and Marking Details: Pages 132-135

Standard Color: Gray

Alternate colors available as indicated below:

COLOR	SUFFIX
Beige	BG
Brown	BR
Blue	BU
Black	BK
Orange	F
Green	G
Red	R
White	W
Yellow	Y

ATD4	ATDS4
	
<i>Separate circuits</i>	<i>Circuits bussed internally</i>

Specifications							
Pitch	6 mm		6 mm				
Height x Width	54 x 55.5 mm		54 x 55.5 mm				
Wire Range UL	20-10 AWG		22-10 AWG				
Strip Length	9 mm		9 mm				
Ratings							
							
Rated Cross Section	22-10 AWG	0.5-4 sq.mm	22-10 AWG	22-10 AWG	0.5-4 sq.mm	22-10 AWG	
Voltage Rating	300 V	400 V	300 V	300 V	400 V	300 V	
Current Rating	35 A	32 A	35 A	35 A	32 A	35 A	
Torque	7 lb-in	0.5 Nm	7 lb-in	7 lb-in	0.5 Nm	7 lb-in	
Accessories							
INSULATION							
End Plate						ATD4EP	
Separator Plate						ATD4SP	
MOUNTING							
Mounting Rail (std. rail is 1.0 meters pre-slotted)						ATBDR321 ATBDR351 ATBDR35151	
End Stop						ATB2EC1	
INTERCONNECTION							
Pre Assembled Shorting Links	2 pole					ATD4SL12	
	3 pole					ATD4SL13	
	10 pole					ATD4SL110	
Insulated Pre Assembled Shorting Links	2 pole					ATD4SL22	
	3 pole					ATD4SL23	
	10 pole					ATD4SL210	
Insulated Comb Type Shorting Link	2 pole					ATD4CL12	
	3 pole					ATD4CL13	
	10 pole					ATD4CL110	
Test Socket						ATD4TS	
Marking							
Marking Tags	K Type						ATD4MT1

Offset Double Level Feed-Through Blocks

OFFSET DOUBLE LEVEL FEED-THROUGH BLOCKS

Offset double level blocks incorporate a design feature wherein upper level contacts are offset from the bottom level by half the thickness of the block. This provides easier access to bottom level contact screws, permits bussing interconnections to be utilized at both levels, and improves the visibility of lower level marking tags by offsetting them from the wires.

Universal mounting provisions allow the blocks to be utilized with all three standard mounting rails indicated in the accompanying table. Tapped holes in the current bar, facilitating bus bar or test socket connections.

Electrical characteristics and ratings, as well as recommendations covering the broad range of accessories utilized with these blocks, are also indicated in the accompanying tables.

Insulation Material:
Polyamide



Accessory and Marking Details: Pages 132-135

Standard Color: Gray

Alternate colors available as indicated below:

COLOR	SUFFIX
Blue	BU
Black	BK
Red	R
Yellow	Y



Specifications						
Pitch	6 mm		6 mm			
Height x Width	63 x 68 mm		63 x 68 mm			
Wire Range UL	22-10 AWG		22-10 AWG			
Strip Length	9 mm		9 mm			
Ratings						
						
Rated Cross Section	22-12 AWG	0.5-4 sq.mm	22-10 AWG	22-10 AWG	0.5-4 sq.mm	22-10 AWG
Voltage Rating	600 V	630 V	600 V	600 V	630 V	600 V
Current Rating	35 A	32 A	35 A *	35 A	32 A	35 A *
Torque	7 lb-in	0.5 Nm	7 lb-in	7 lb-in	0.5 Nm	7 lb-in
Accessories						
INSULATION						
End Plate	Front		ATDA4EP1			
	Back		ATDA4EP2			
MOUNTING						
Mounting Rail	(std. rail is 1.0 meters pre-slotted)			ATBDR321		
				ATBDR351		
				ATBDR35151		
End Stop				ATB2EC1		
INTERCONNECTION						
Pre Assembled Shorting Links	2 pole		ATDA4SL12			
	3 pole		ATDA4SL13			
	10 pole		ATDA4SL110			
Insulated Pre Assembled Shorting Links	2 pole		ATDA4SL22			
	3 pole		ATDA4SL23			
	10 pole		ATDA4SL210			
Insulated Comb Type Shorting Link	2 pole		ATDA4CL12			
	3 pole		ATDA4CL13			
	10 pole		ATDA4CL110			
Test Socket				ATDA4TS		
Marking						
Marking Tags	K Type		ATDA4MT1			

* Limited VA rating of 5A maximum at 600 V for General Industrial use.

TRIPLE LEVEL TERMINAL BLOCKS

Triple level blocks provide both ultra-high density inter-connect capability and housing for sensor and actuator applications.

The ATTL2 and ATTA2 versions (page 109) provide LED switching indication. Please contact Amphenol Pcd to review additional electronic component packaging options with these blocks.

Universal mounting provisions allow the blocks to be utilized with all three standard mounting rails indicated in the accompanying table. Tapped holes in the current bar facilitate bus bar or test socket connections.

Electrical characteristics and ratings, as well as recommendations covering the broad range of accessories utilized with these blocks, are also indicated in the accompanying tables.

Insulation Material:
Polyamide













Accessory and Marking Details: Pages 132-135

Standard Color: Gray

Alternate colors available as indicated below:

COLOR	SUFFIX
Blue	BU
Black	BK
Red	R
Yellow	Y



Specifications						
Pitch	6 mm		6 mm			
Height x Width	67 x 84 mm		67 x 61 mm			
Wire Range UL	24-12 AWG		24-12 AWG			
Strip Length	9 mm		9 mm			
Ratings						
						
Rated Cross Section	22-12 AWG	0.5-2.5 sq.mm	24-12 AWG	22-12 AWG	0.5-2.5 sq.mm	24-12 AWG
Voltage Rating	300 V	400 V	300 V	300 V	400 V	300 V
Current Rating	25 A	24 A	25 A	25 A	24 A	25 A
Torque	4.5 lb-in	0.4 Nm	4.5 lb-in	4.5 lb-in	0.4 Nm	4.5 lb-in
Accessories						
INSULATION						
End Plate		ATT2EP	ATTA2EP			
MOUNTING						
Mounting Rail (std. rail is 1.0 meters pre-slotted)		ATBDR321 ATBDR351 ATBDR35151				
End Stop		ATB2EC1				
INTERCONNECTION						
Pre Assembled Shorting Links	2 pole 3 pole 10 pole		ATT2SL12 ATT2SL13 ATT2SL110			
Insulated Comb Type Shorting Link	2 pole 3 pole 10 pole		ATT2CL12 ATT2CL13 ATT2CL110			
Test Socket		ATT2TS				
Marking						
Marking Tags	K Type		ATT2MT1			

Triple Level Terminal Blocks

ATTL2			ATTAL2		
					
Accommodates 12 V D.C. LED for switching indication			Accommodates 12 V D.C. LED for switching indication		
6 mm			6 mm		
67 x 84 mm			67 x 61 mm		
24-12 AWG			24-12 AWG		
9 mm			9 mm		
					
24-12 AWG	0.5-2.5 sq.mm	24-12 AWG	24-12 AWG	0.5-2.5 sq.mm	24-12 AWG
300 V	400 V	300 V	300 V	400 V	300 V
25 A	24 A	25 A	25 A	24 A	25 A
4.5 lb-in	0.4 Nm	4.5 lb-in	4.5 lb-in	0.4 Nm	4.5 lb-in
ATT2EP			ATTA2EP		
ATBDR321 ATBDR351 ATBDR35151					
ATB2EC1					
ATT2SL12 ATT2SL13 ATT2SL110					
ATT2CL12 ATT2CL13 ATT2CL110					
ATT2TS					
ATT2MT1					

SINGLE LEVEL FUSED SWITCHING BLOCKS

Fused feed-through terminal blocks incorporate a hinged carrier which introduces a standard 5x20mm or 5x25mm fuse into the circuit. Circuits can be manually interrupted by opening the fuse carrier arm.

Note: Blocks are supplied with a 6.3A fast blow fuse. Please contact Amphenol Pcd to review other options.

ATFL4 Series blocks provide LED indication in case of fuse failure, and are available for 110V and 220V circuits.

Universal mounting provisions allow the blocks to be utilized with all three standard mounting rails.

Electrical characteristics and ratings, as well as recommendations covering the broad range of accessories utilized with these blocks, are also indicated in the accompanying tables.

Insulation Material:
Polyamide

Accessory and Marking Details: Pages 132-135

Standard Color: Gray



Alternate colors available as indicated below:

COLOR	SUFFIX	ATFL4220 SUFFIX
Blue	BU	BU220
Black	BK	BK220
Red	R	R220
Yellow	Y	Y220



Specifications						
Pitch	8 mm		8 mm			
Height x Width	43 x 58 mm		43 x 58 mm			
Wire Range UL	22-10 AWG		22-10 AWG			
Strip Length	9.5 mm		9.5 mm			
Ratings						
						
Rated Cross Section	22-10 AWG	0.5-4 sq.mm	22-10 AWG	22-10 AWG	0.5-4 sq.mm	22-10 AWG
Voltage Rating	600 V	500 V	600 V	600 V	500 V	600 V
Current Rating	6.3 A	6.3 A	6.3 A	6.3 A	6.3 A	6.3 A
Torque	7 lb-in	0.5 Nm	7 lb-in	7 lb-in	0.5 Nm	7 lb-in
Accessories						
INSULATION						
End Plate		ATF4EP				
Partition Plate		ATF4PP				
MOUNTING						
Mounting Rail (std. rail is 1.0 meters pre-slotted)		ATBDR321 ATBDR351 ATBDR35151				
End Stop		ATB2EC1				
INTERCONNECTION						
Insulated Comb Type Shorting Link	2 pole	ATF4CL12				
	3 pole	ATF4CL13				
	10 pole	ATF4CL110				
						
Marking						
Marking Tag	Block		ATF4MT1			
Marking Tag	Carrier Arm		ATF6MT1			

Single Level Fused Switching Blocks

ATF6		
		
8 mm		
60 x 43 mm		
22-8 AWG		
9.5 mm		
		
22-8 AWG	1.5-6 sq.mm	22-8 AWG
300 V	500 V	300 V
10 A	6.3 A	10 A
14 lb-in	0.8 Nm	14 lb-in
ATF6EP		
ATBDR321 ATBDR351 ATBDR35151		
ATB2EC1		
ATF6CL12 ATF6CL13 ATF6CL110		
ATF4MT1		

DOUBLE LEVEL FUSED SWITCHING BLOCKS

Double level fused feed-through terminal blocks incorporate a hinged carrier which introduces a standard 5x20mm or 5x25mm fuse into the circuit on the top level, and a separate feed through terminal connection at the lower level. Upper circuits can be manually interrupted by opening the fuse carrier arm.

ATD1F4 and ATD1FL4 versions are internally bussed, providing two equipotential terminations on each side of the block. (The two sides are interconnected through the upper circuit when the fuse carrier arm is closed.)

ATDFL4 and ATD1FL4 versions provide LED indication of fuse failure. See table for listings of part numbers for various circuit voltage options. Please contact Amphenol Pcd to review other options.

Note: Blocks are supplied with a 6.3A fast blow fuse. Please contact Amphenol Pcd to review other options.

Insulation Material:
Polyamide

Accessory and Marking Details: Pages 132-135

Standard Color: Gray

Alternate colors available as indicated below:



COLOR	SUFFIX
Blue	BU
Black	BK
Red	R
Yellow	Y
Green	G





Specifications						
Pitch	8 mm		8 mm			
Height x Width	66 x 88 mm		66 x 88 mm			
Wire Range UL	22-10 AWG		22-10 AWG			
Strip Length	9.5 mm		9.5 mm			
Ratings						
Rated Cross Section	22-12 AWG	0.5-4 sq.mm	22-10 AWG	22-10 AWG	0.5-4 sq.mm	22-10 AWG
Voltage Rating	600 V	500 V	600 V	600 V	500 V	600 V
Current Rating	Top Level Bottom Level	6.3 A 25 A	6.3 A 32 A	6.3 A 35 A	6.3 A 6.3 A	6.3 A
Torque	7 lb-in	0.5 Nm	7 lb-in	7 lb-in	0.5 Nm	7 lb-in
Accessories						
INSULATION						
End Plate		ATDF4EP				
MOUNTING						
Mounting Rail (std. rail is 1.0 meters pre-slotted)		ATBDR321 ATBDR351 ATBDR35151				
End Stop		ATB2EC1				
INTERCONNECTION						
Pre Assembled Shorting Links	2 pole 3 pole 10 pole		ATDF4SL12 ATDF4SL13 ATDF4SL110	ATD1F4SL12 ATD1F4SL13 ATD1F4SL110		
Insulated Pre Assembled Shorting Links	2 pole 3 pole 10 pole		ATDF4SL22 ATDF4SL23 ATDF4SL210	ATD1F4SL22 ATD1F4SL23 ATD1F4SL210		
Insulated Comb Type Shorting Link	2 pole 3 pole 10 pole		ATDF4CL12 ATDF4CL13 ATDF4CL110	ATD1F4CL12 ATD1F4CL13 ATD1F4CL110		
Marking						
Marking Tags	K Type		ATDF4MT1			

Double Level Fused Blocks With Indicator Light

DIN-Rail Blocks

ATDFL4											
											
LED indicator											
8 mm											
66 x 88 mm											
22-10 AWG											
9.5 mm											
ATDFL4 Circuit Voltage											
<table border="1" style="width: 100%; border-collapse: collapse;"> <tr> <td style="width: 33%; text-align: center;">24 V AC/DC</td> <td style="width: 33%; text-align: center;">ATDFL4</td> <td style="width: 33%;"></td> </tr> <tr> <td style="text-align: center;">110 V AC/DC</td> <td style="text-align: center;">ATDFL4110</td> <td></td> </tr> <tr> <td style="text-align: center;">220 V AC/DC</td> <td style="text-align: center;">ATDFL4220</td> <td></td> </tr> </table>			24 V AC/DC	ATDFL4		110 V AC/DC	ATDFL4110		220 V AC/DC	ATDFL4220	
24 V AC/DC	ATDFL4										
110 V AC/DC	ATDFL4110										
220 V AC/DC	ATDFL4220										
											
22-12 AWG	0.5-4 sq.mm	22-10 AWG									
600 V	500 V	600									
6.3 A	6.3 A	6.3 A									
25 A	32 A	35 A									
7 lb-in	0.5 Nm	7 lb-in									
ATDF4EP											
ATBDR321 ATBDR351 ATBDR35151											
ATB2EC1											
ATDF4SL12 ATDF4SL13 ATDF4SL110											
ATDF4SL22 ATDF4SL23 ATDF4SL210											
ATDF4CL12 ATDF4CL13 ATDF4CL110											
ATDF4MT1											

ATD1FL4					
					
LED indicator Internally bussed					
8 mm					
66 x 88 mm					
20-10 AWG					
9.5 mm					
ATD1FL4 Circuit Voltage					
<table border="1" style="width: 100%; border-collapse: collapse;"> <tr> <td style="width: 33%; text-align: center;">24 V AC/DC</td> <td style="width: 33%; text-align: center;">ATD1FL4</td> <td style="width: 33%;"></td> </tr> </table>			24 V AC/DC	ATD1FL4	
24 V AC/DC	ATD1FL4				
					
22-12 AWG	0.5-4 sq.mm	22-10 AWG			
600 V	500 V	600 V			
6.3 A	6.3 A	6.3 A			
7 lb-in	0.5 Nm	7 lb-in			
ATDF4EP					
ATBDR321 ATBDR351 ATBDR35151					
ATB2EC1					
ATD1F4SL12 ATD1F4SL13 ATD1F4SL110					
ATD1F4SL22 ATD1F4SL23 ATD1F4SL210					
ATD1F4CL12 ATD1F4CL13 ATD1F4CL110					
ATDF4MT1					

DISCONNECT AND TEST TERMINAL BLOCKS

Disconnect and test terminal blocks are specifically designed for use with measuring, control and regulatory circuits, and feature socket-headed screws that have been precision-designed to act as test monitoring points. Circuits can be isolated for testing and repair without disconnecting wires.

The ATSA6 and ATSB6 Series utilize a screwdriver-actuated slide link to make and break connections.

The ATSC4 features a lever-operated knife contact.

The ATSD6 incorporates a hinged connecting link.

Universal mounting provisions allow the blocks to be utilized with all three standard mounting rails.

Electrical characteristics and ratings, as well as recommendations covering the broad range of accessories utilized with these blocks, are also indicated in the accompanying tables.

Insulation Material:
Polyamide









Accessory and Marking Details: Pages 132-135

Standard Color: Gray







Alternate colors available as indicated below:

COLOR	SUFFIX
Blue	BU
Black	BK
Red	R
Yellow	Y



Specifications						
Pitch	8 mm		16 mm			
Height x Width	57 x 63 mm		57 x 63 mm			
Wire Range UL	16-8 AWG		16-8 AWG			
Strip Length	12 mm		12 mm			
Ratings						
						
Rated Cross Section	16-8 AWG	1.5-6 sq.mm	16-8 AWG	16-8 AWG	1.5-6 sq.mm	16-8 AWG
Voltage Rating	600 V	750 V	600 V	300 V	300 V	300 V
Current Rating	41 A	41 A	41 A	10 A	10 A	10 A
Torque	14 lb-in	1.2 Nm	14 lb-in	14 lb-in	1.2 Nm	14 lb-in
Accessories						
INSULATION						
End Plate		ATSE6EP				
MOUNTING						
Mounting Rail (std. rail is 1.0 meters pre-slotted)		ATBDR321 ATBDR351 ATBDR35151				
End Stop		ATB2EC1				
INTERCONNECTION						
Insulated Comb Type Shorting Link	2 pole	ATSA6CL12				
	3 pole	ATSA6CL13				
	10 pole	ATSA6CL110				
Marking						
Marking Tags	K Type		ATSA6MT1			

Disconnect and Test Terminal Blocks

ATSC4			ATSD6		
					
<i>Knife contact</i>			<i>Hinged link</i>		
6 mm			8 mm		
46 x 46.3 mm			60 x 43 mm		
22-12 AWG			22-8 AWG		
9 mm			9.5 mm		
					
22-10 AWG	0.5-1.5 sq.mm	22-12 AWG	22-8 AWG	1.5-6 sq.mm	22-8 AWG
600 V	800 V	600 V	300 V	500 V	300 V
16 A	16 A	16 A	10 A	6.3 A	10 A
7 lb-in	0.5 Nm	7 lb-in	14 lb-in	0.8 Nm	14 lb-in
ATSC4EP			ATF6EP		
ATBDR321 ATBDR351 ATBDR35151					
ATB2EC1					
ATSA6CL12 ATSA6CL13 ATSA6CL110					
ATSC4MT1			ATSA6MT1		

GROUND BLOCKS

The distinctively colored green and yellow (in accordance with international standards) ground terminal blocks are installed by a center locking screw mechanism, and provide a secure metal-to-metal connection to the mounting rail and panel, with the rail functioning as a ground potential bus bar. Designs feature high-torque clamping yokes and vibration-proof screw-actuated grounding.

Electrical characteristics and ratings, as well as recommendations covering the broad range of accessories utilized with these blocks, are also indicated in the accompanying tables. Because of the secure electrical and mechanical screw connection to the rail, ground clamps also act as end stops.

Insulation Material:
Polyamide





Accessory and Marking Details: Pages 132-135

Standard Color:
Green/Yellow



Specifications						
Pitch	6 mm		6 mm			
Height x Width	48 x 43 mm		47 x 54.5 mm			
Wire Range UL	22-10 AWG		22-8 AWG			
Strip Length	9 mm		12 mm			
Ratings						
						
Rated Cross Section	22-10 AWG	0.5-4 sq.mm	22-10 AWG	22-8 AWG	0.5-6 sq.mm	22-8 AWG
Voltage Rating	800 V			800 V		
Current Rating	32 A			41 A		
Torque	7 lb-in	0.5 Nm	7 lb-in	14 lb-in	0.8 Nm	14 lb-in
Accessories						
MOUNTING						
Mounting Rail (std. rail is 1.0 meters pre-slotted)		ATBDR321 ATBDR351 ATBDR35151		ATBDR351 ATBDR35151		
Marking						
Marking Tags	K Type		ATG4MT1		ATG6MT1	

Ground Blocks/Thermocouple Blocks

ATGX10			ATGX35		
					
10 mm			16 mm		
50 x 45 mm			61.5 x 58 mm		
16-8 AWG			8-2 AWG		
12 mm			18 mm		
					
22-6 AWG	1.5-10 sq.mm	16-8 AWG	8-2 AWG	10-35 sq.mm	8-2 AWG
800 V			800 V		
57 A			125 A		
14 lb-in	1.2 Nm	14 lb-in	25 lb-in	2.5 Nm	25 lb-in
ATBDR321 ATBDR351 ATBDR35151			ATBDR321 ATBDR35151		
ATGX10MT1			ATGX35MT1		

THERMOCOUPLE TERMINAL BLOCKS

Thermocouple terminal blocks are recommended to assure accurate temperature measurement on thermocouple circuits. The ATC2-Series blocks feature bus bars fabricated of the same material as the thermocouple wires. Specific catalog numbers for each thermocouple type are indicated below:

recommendations covering the broad range of accessories utilized with these blocks, are also indicated in the accompanying tables.

Insulation Material:
Polyamide

Accessory and Marking Details: Pages 132-135

Standard Color: Gray







TYPE MATERIALS

ATC2K Chromel/Alumel
 ATC2J Iron/Constantan
 ATC2T Copper/Constantan

Universal mounting provisions allow the blocks to be utilized with all three standard mounting rails.

Electrical characteristics and ratings, as well as



Specifications			
Pitch	10 mm		
Height x Width	45 x 43 mm		
Wire Range UL	24-14 AWG		
Strip Length	9 mm		
Ratings			
Rated Cross Section	24-14 AWG	0.5-2.5 sq.mm	24-14 AWG
Voltage Rating	300 V	400 V	300 V
Current Rating	10 A	10 A	10 A
Torque	7 lb-in	0.5 Nm	7 lb-in
Accessories			
INSULATION			
End Plate		ATB2EP	
Partition Plate		ATB2PP	
Separator Plate		ATB2SP	
MOUNTING			
Mounting Rail (std. rail is 1.0 meters pre-slotted)		ATBDR321 ATBDR351 ATBDR35151	
End Stop		ATB2EC1	
Marking			
Marking Tags	K Type 	ATB2MT1	

EXPLOSION PROOF/HARSH ENVIRONMENT BLOCKS

Designed and developed specifically for critical and harsh environment applications, these blocks are available in seven sizes covering the wire range AWG24 - AWG2.

Explosion proof blocks are particularly recommended for chemical and petrochemical industry applications. The blocks in this Series are designated for AEx ell and Ex ell applications; Class I, Zone I hazardous locations. All blocks comply to EN50019, including 100% testing at 120% of test voltage.

Note: for Zone I applications, blocks should be installed in a terminal box or system with EEx e designation and a minimum of IP54 protection.

Insulation Material:
Polyamide

**Accessory and Marking
Details:** Pages 132-135

Standard Color: Gray

Alternate colors available as indicated below:



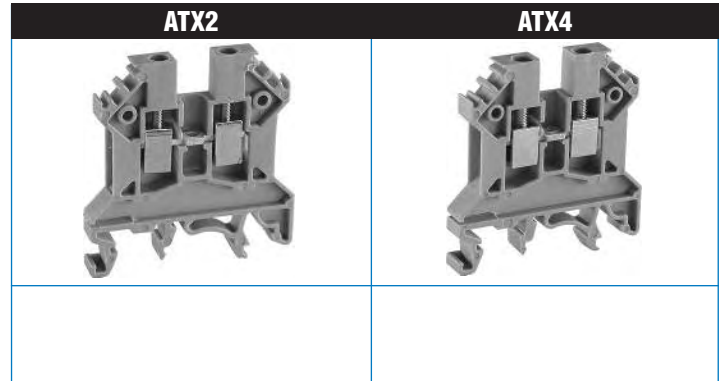





COLOR	SUFFIX
Beige	BG
Brown	BR
Blue	BU
Black	BK
Orange	F
Green	G
Red	R
White	W
Yellow	Y



Specifications						
Pitch	5 mm		6 mm			
Height x Width	45 x 43 mm		45 x 43 mm			
Wire Range UL	24-14 AWG		22-10 AWG			
Strip Length	9 mm		9 mm			
Ratings						
Rated Cross Section	22-12 AWG	0.5-2.5 sq.mm	24-14 AWG	22-10 AWG	0.5-4 sq.mm	22-10 AWG
Voltage Rating	600 V	800 V	600 V	600 V	800 V	600 V
Current Rating	25 A	24 A	20 A	35 A	32 A	35 A
Torque	7 lb-in	0.4 Nm	7 lb-in	7 lb-in	0.5 Nm	7 lb-in
Accessories						
INSULATION						
End Plate						ATX2EP
Partition Plate						ATX2PP
Separator Plate						ATX2SP
MOUNTING						
Mounting Rail (std. rail is 1.0 meters pre-slotted)						ATBDR321 ATBDR351 ATBDR35151
End Stop						ATB2EC1
INTERCONNECTION						
Pre Assembled Shorting Links	2 pole					ATX2SL12
	3 pole					ATX2SL13
	10 pole					ATX2SL110
Insulated Pre Assembled Shorting Links	2 pole					ATX2SL22
	3 pole					ATX2SL23
	10 pole					ATX2SL210
Insulated Comb Type Shorting Link	2 pole					ATX2CL12
	3 pole					ATX2CL13
	10 pole					ATX2CL110
Test Socket						ATX2TS
Marking						
Marking Tags	K Type					ATX2MT1
						ATX4MT1

Explosion Proof/ Harsh Environment Blocks

DIN-Rail Blocks

ATX6			ATX10			ATX16			ATX25		
											
8 mm			10 mm			12 mm			12 mm		
47 x 43 mm			47 x 43 mm			47 x 43 mm			56 x 49 mm		
22-8 AWG			20-6 AWG			20-4 AWG			14-2 AWG		
12 mm			12 mm			16 mm			18 mm		
											
22-8 AWG	1.5-6 sq.mm	22-8 AWG	22-6 AWG	1.5-10 sq.mm	20-7 AWG	22-4 AWG	2.5-16 sq.mm	14-4 AWG	12-2 AWG	6-25 sq.mm	14-2 AWG
600 V	800 V	600 V	600 V	800 V	600 V	600 V	800 V	600 V	600 V	800 V	600 V
50 A	41 A	50 A	65 A	57 A	65 A	85 A	76 A	85 A	115 A	101 A	115 A
9 lb-in	0.8 Nm	14 lb-in	14 lb-in	1.2 Nm	14 lb-in	14 lb-in	2.0 Nm	14 lb-in	14 lb-in	2.0 Nm	14 lb-in
ATX6EP									ATX25EP		
ATX6PP									ATX25PP		
ATX6SP						ATX16SP					
ATBDR321 ATBDR351 ATBDR35151											
ATB2EC1											
ATX6SL12			ATX10SL12			ATX16SL12			ATX25SL12		
ATX6SL13			ATX10SL13			ATX16SL13			ATX25SL13		
ATX6SL110			ATX10SL110			ATX16SL110			ATX25SL110		
ATX6SL22			ATX10SL22			ATX16SL22			ATX25SL22		
ATX6SL23			ATX10SL23			ATX16SL23			ATX25SL23		
ATX6SL210			ATX10SL210			ATX16SL210			ATX25SL210		
ATX6CL12			ATX10CL12								
ATX6CL13			ATX10CL13								
ATX6CL110			ATX10CL110								
			ATX6TS						ATX25TS		
ATX6MT1			ATX10MT1						ATX16MT1		

ATX35



Specifications

Pitch	15 mm
Height x Width	58 x 52.5 mm
Wire Range UL	18-2 AWG
Strip Length	18 mm

Ratings



			
Rated Cross Section	8-2 AWG	10-35 sq.mm	18-2 AWG
Voltage Rating	600 V	800 V	600 V
Current Rating	145 A	125 A	145 A
Torque	25 lb-in	2.5 Nm	25 lb-in

Accessories





INSULATION

End Plate		ATX2EP
Partition Plate		ATX2PP
Separator Plate		ATX2SP

MOUNTING

Mounting Rail (std. rail is 1.0 meters pre-slotted)		ATBDR321 ATBDR351 ATBDR35151
End Stop		ATB2EC1

INTERCONNECTION

Pre Assembled Shorting Links	2 pole		ATX35SL12
	3 pole		ATX35SL13
	10 pole		ATX35SL110
Insulated Pre Assembled Shorting Links	2 pole		ATX35SL22
	3 pole		ATX35SL23
	10 pole		ATX35SL210
Insulated Comb Type Shorting Link	2 pole		ATX35CL12
	3 pole		ATX35CL13
	10 pole		ATX35CL110
Test Socket		ATX25TS	

Marking

Marking Tags	K Type		ATX25MT1
---------------------	--------	---	----------

Stud Mount Terminal Blocks

STUD MOUNT TERMINAL BLOCKS

Stud mount blocks are recommended for applications where a crimp wire termination is desired. Wires are installed in a ring or fork tongue compression terminal, which is then screwed down against the flat terminal block surface. Insulated and uninsulated shorting links and protective insulating covers facilitate protection and interconnection.

Universal mounting provisions allow the blocks to be utilized with all three standard mounting rails indicated in the accompanying table. A protective well in the center of the block provides access to a tapped hole in the current bar, facilitating bus bar or test socket connections.

Electrical characteristics and ratings, as well as recommendations covering the broad range of accessories utilized with these blocks, are also indicated in the accompanying tables.

Insulation Material:
Polyamide









**Accessory and Marking
Details:** Pages 132-135

Standard Color: Gray

Alternate colors available
as indicated below:

COLOR	SUFFIX
Beige	BG
Brown	BR
Blue	BU
Black	BK
Orange	F
Green	G
Red	R
White	W
Yellow	Y



Specifications						
Pitch	17 mm			17 mm		
Height x Width	44.5 x 50 mm			44.5 x 50 mm		
Wire Range UL	22-6 AWG			22-4 AWG		
Strip Length	12 mm			12 mm		
Ratings						
Rated Cross Section	22-6 AWG	1.5-10 sq.mm	22-6 AWG	22-4 AWG	0.5-16 sq.mm	22-4 AWG
Voltage Rating	600 V	800 V	600 V	600 V	800 V	600 V
Current Rating	65 A	57 A	65 A	80 A	76 A	80 A
Torque	14 lb-in	1.2 Nm	14 lb-in	17.5 lb-in	2.0 Nm	17.5 lb-in
Accessories						
INSULATION						
End Plate		ATBB4EP				
MOUNTING						
Mounting Rail (std. rail is 1.0 meters pre-slotted)		ATBDR321 ATBDR351 ATBDR35151				
End Stop		ATB2EC1				
INTERCONNECTION						
Protective Cover for Covering	2 Terminal 3 Terminal		ATBB4PC2 ATBB4PC3			
Protective Cover in Length	100 mm 200 mm 300 mm		ATBB4PC100 ATBB4PC200 ATBB4PC300			
Removable Shorting Links	2 way 3 way 4 way		ATBB4SL52 ATBB4SL53 ATBB4SL54			
Insulated Removable Shorting Links	2 way 3 way 4 way		ATBB4SL72 ATBB4SL73 ATBB4SL74			
Marking						
Marking Tags	K Type		ATBB4MT1			

SPRING-CLAMP FEED-THROUGH BLOCKS

Screwless spring-clamp blocks – designed to simplify installation and save time and labor – are available for stranded and solid wires from AWG22 - 8. Individual spring contact clamps are depressed to insert a wire by using a screwdriver. Once released, the spring clamp maintains a consistent, high pressure contact against the wire.

Insulation Material: Polyamide









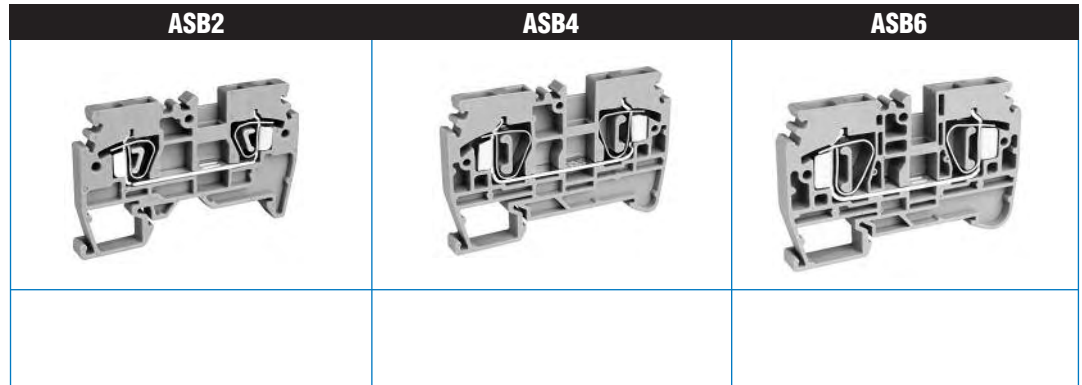







Accessory and Marking Details: Pages 132-135

Standard Color: Gray

Alternate colors available as indicated below:

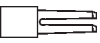
COLOR	SUFFIX	COLOR	SUFFIX	COLOR	SUFFIX
Beige	BG	Brown	BR	Blue	BU
Black	BK	Orange	F	Green	G
Red	R	White	W	Yellow	Y



Specifications										
Pitch	5 mm			6mm			8mm			
Height x Width	36 x 58 mm			42 x 65 mm			45 x 72 mm			
Wire Range UL	22-14 AWG			22-12 AWG			22-8 AWG			
Strip Length	9 mm			9 mm			12 mm			
Ratings										
										
Rated Cross Section	22-14 AWG #	0.5-2.5 sq.mm	22-14 AWG	22-12 AWG #	0.5-4 sq.mm	22-12 AWG	22-8 AWG #	0.5-6 sq.mm	22-8 AWG	
Voltage Rating	600 V	800 V	600 V	600 V	800 V	600 V	600 V	800 V	600 V	
Current Rating	20 A	24 A	20 A	25 A	32 A	25 A	50 A	41 A	50 A	
Accessories										
End Plate		ASB2EP			ASB4EP			ASB6EP		
Partition Plate		ASB2PP			ASB4PP			ASB6PP		
MOUNTING										
Mounting Rail (std. rail is 1.0 meters pre-slotted)					ATBDR351 ATBDR35151					
End Stop					ATB2EC1					
INTERCONNECTION										
Insulated Push-In Type* Shorting Link (2 way)		ASB2SL2			ASB4SL2			ASB6SL2		
Insulated Push-In Type (wire) Shorting Link		ASB2SL22			ASB4SL22					
Alternate Link		ASB2SL21			ASB4SL21			ASB6SL21		
Marking										
Marking Tags K Type		ASB2MT1			ASB4MT1			ASB6MT1		

* Current Rating: 10A, wire length 110 mm # For Stranded conductor only

Spring-Clamp Ground Blocks

SPRING-CLAMP GROUND BLOCKS

Screwless spring-clamp ground blocks – designed to simplify installation and save time and labor – are available for stranded and solid wires from AWG22 - 8. Individual spring contact clamps are depressed to insert a wire by using a screwdriver. Once released, the spring clamp maintains a consistent, high pressure contact against the wire. Integral, heavy duty mounting springs firmly lock

the blocks to the mounting track, and provide a vibration-proof grounding connection.

Insulation Material: Polyamide

Accessory and Marking Details: Pages 132-135

Standard Color: Green and Yellow



Specifications										
Pitch	5 mm			6 mm			8 mm			
Height x Width	36 x 58 mm			42 x 65 mm			45 x 72 mm			
Wire Range UL	22-14 AWG			22-12 AWG			22-8 AWG			
Strip Length	9 mm			9 mm			12 mm			
Ratings										
										
Rated Cross Section	22-14 AWG	0.5-2.5 sq.mm	22-14 AWG	22-12 AWG	0.5-4 sq.mm	22-12 AWG	22-8 AWG	0.5-6 sq.mm	22-8 AWG	
Voltage Rating	800 V			800 V			800 V			
Current Rating	24 A			32 A			41 A			
Accessories										
MOUNTING										
Mounting Rail (std. rail is 1.0 meters pre-slotted) 				ATBDR351 ATBDR35151						
Marking										
Marking Tags 	K Type	ATB2MT1			ATB4MT1			ATB6MT1		

SPRING-CLAMP MULTIPLE CONNECTION FEED- THROUGH BLOCKS

Multiple connection screwless spring-clamp feed-through blocks feature one or two contact points per side for enhanced density and system convenience, and reduce the need for bussing clips. Individual spring contact clamps are depressed to insert a wire by using a screwdriver. Once released, the spring clamp maintains a consistent, high pressure contact against the wire.



Insulation Material:
Polyamide













**Accessory and Marking
Details:** Pages 132-135

Standard Color: Gray

Alternate colors available
as indicated below:

COLOR	SUFFIX
Beige	BG
Brown	BR
Blue	BU
Black	BK
Orange	F
Green	G
Red	R
White	W
Yellow	Y

ASBM21	ASBM22
	
3 Contact	4 Contact

Specifications						
Pitch	5 mm		6 mm			
Height x Width	36 x 74 mm		36 x 90 mm			
Wire Range UL	22-14 AWG		22-14 AWG			
Strip Length	9 mm		9 mm			
Ratings						
						
Rated Cross Section	22-14 AWG	0.5-2.5 sq.mm	22-14 AWG	22-14 AWG	0.5-2.5 sq.mm	22-14 AWG
Voltage Rating	600 V	800 V	600 V	600 V	800 V	600 V
Current Rating	20 A	24 A	20 A	20 A	24 A	20 A
Accessories						
INSULATION						
End Plate		ASBM21EP	ASBM22EP			
MOUNTING						
Mounting Rail (std. rail is 1.0 meters pre-slotted)				ATBDR351 ATBDR35151		
End Stop				ATB2EC1		
INTERCONNECTION						
Insulated Push-In Type* Shorting Link (2 way)				ASB2SL2		
Insulated Push-In Type (wire) Shorting Link				ASB2SL22		
Alternate Link				ASB2SL21		
Marking						
Marking Tags	K Type		ATB2MT1			

* Current Rating 10A, wire length 110mm

Spring-Clamp Multiple Connection Feed-Through Blocks

DIN-Rail Blocks

ASBM41			ASBM42			ASBM62		
								
3 Contact			4 Contact			3 contact		
6 mm			6 mm			8 mm		
42 x 85 mm			42 x 105 mm			45 x 94 mm		
22-12 AWG			22-12 AWG			22-8 AWG		
9 mm			9 mm			12 mm		
								
22-12 AWG	0.5-4 sq.mm	22-12 AWG	22-12 AWG	0.5-4 sq.mm	22-12 AWG	22-8 AWG	0.5-6 sq.mm	22-8 AWG
600 V	800 V	600 V	600 V	800 V	600 V	600 V	800 V	600 V
25 A	32 A	25 A	25 A	32 A	25 A	50 A	41 A	50 A
ASBM41EP			ASBM42EP			ASBM62EP		
ATBDR351 ATBDR35151								
ATB2EC1								
ASB4SL2						ASB6SL2		
ASB4SL22								
ASB4SL21						ASB6SL21		
ATB4MT1								
ATB4MT1						ATB6MT1		

SPRING-CLAMP ANGLED FEED- THROUGH BLOCKS

Angled screwless spring-clamp feed-through blocks provide a compact interconnect system and convenient circuit identification for space-sensitive junction box applications. Blocks are available in single and multiple termination variations, for wire sizes AWG22 - 12.

Individual spring contact clamps are depressed to insert a wire by using a screwdriver. Once released, the spring clamp maintains a consistent, high pressure contact against the wire.

Insulation Material:
Polyamide







**Accessory and Marking
Details:** Pages 132-135

Standard Color: Gray

Alternate colors available as indicated below:

COLOR	SUFFIX
Beige	BG
Brown	BR
Blue	BU
Black	BK
Orange	F
Green	G
Red	R
White	W
Yellow	Y



Specifications						
Pitch	5 mm		5 mm			
Height x Width	42 x 54 mm		42 x 54 mm			
Wire Range UL	22-14 AWG		22-14 AWG			
Strip Length	9 mm		9 mm			
Ratings						
Rated Cross Section	22-14 AWG	0.5-2.5 sq.mm	22-14 AWG	22-14 AWG	0.5-2.5 sq.mm	22-14 AWG
Voltage Rating	600 V	800 V	600 V	600 V	800 V	600 V
Current Rating	20 A	24 A	20 A	20 A	24 A	20 A
Accessories						
INSULATION						
End Plate		ASA2EP		ASMA21EP		
MOUNTING						
Mounting Rail (std. rail is 1.0 meters pre-slotted)				ATBDR351 ATBDR35151		
End Stop				ATB2EC1		
INTERCONNECTION						
Insulated Push-In Type* Shorting Link (2 way)				ASA2SL2		
Insulated Push-In Type (wire) Shorting Link				ASB2SL22		
Alternate Link				ASA2SL21		
Marking						
Marking Tags	K Type		ASB2MT1			

* Current Rating 10A, wire length 110mm

Spring-Clamp Angled Feed-Through Blocks

ASMA22			ASMA4			ASMA41			ASMA42		
											
6 mm			6 mm			6 mm			6 mm		
42 x 54 mm			46 x 61.5 mm			46 x 61.5 mm			46 x 61.5 mm		
22-14 AWG			22-12 AWG			22-12 AWG			22-12 AWG		
9 mm			9 mm			9 mm			9 mm		
22-14 AWG	0.5-2.5 sq.mm	22-14 AWG	22-12 AWG	0.5-4 sq.mm	22-12 AWG	22-12 AWG	0.5-4 sq.mm	22-12 AWG	22-12 AWG	0.5-4 sq.mm	22-12 AWG
600 V	800 V	600 V	600 V	800 V	600 V	600 V	800 V	600 V	600 V	800 V	600 V
20 A	24 A	20 A	25 A	32 A	25 A	25 A	32 A	25 A	25 A	32 A	25 A
ASMA22EP			ASMA4EP			ASMA41EP			ASMA42EP		
ATBDR351 ATBDR35151											
ATB2EC1											
ASMA4SL2											
ASB4SL22											
ASMA4SL21											
ASB2MT1			ASB4MT1								

Angled Spring-Clamp Ground Blocks

ANGLED SPRING-CLAMP GROUND BLOCKS

Angled screwless spring-clamp ground blocks – designed to simplify installation and save time and labor – are available for stranded and solid wires from AWG22 - 8. The angled configuration provides a compact interconnect system and convenient circuit identification for space-sensitive junction box applications. Blocks are available in single and multiple termination variations.

Individual spring contact clamps are depressed to insert a wire by using a screwdriver. Once released, the spring clamp maintains a consistent, high pressure contact against the wire. Integral, heavy duty mounting springs firmly lock the blocks to the mounting track, and provide a vibration-proof grounding connection.

Insulation Material:

Polyamide

Accessory and Marking

Details: Pages 132-135

Standard Color:

Green/Yellow

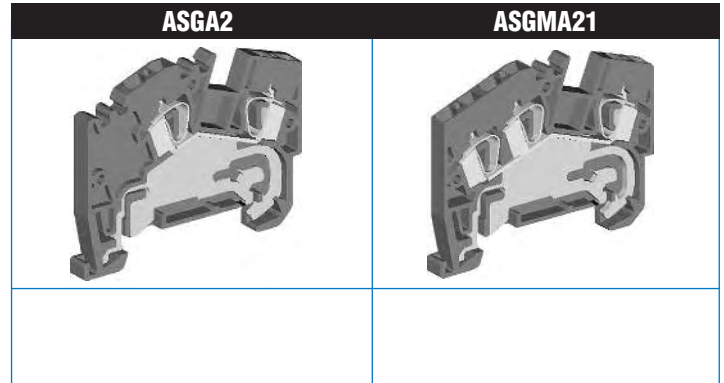

Specifications						
Pitch	5 mm		5 mm			
Height x Width	42 x 54 mm		42 x 54 mm			
Wire Range UL	22-14 AWG		22-14 AWG			
Strip Length	9 mm		9 mm			
Ratings						
Rated Cross Section	22-14 AWG	0.5-2.5 sq.mm	22-14 AWG	22-14 AWG	0.5-2.5 sq.mm	22-14 AWG
Voltage Rating	800 V		800 V			
Current Rating	24 A		24 A			
Accessories						
MOUNTING						
Mounting Rail (std. rail is 1.0 meters pre-slotted)			ATBDR351		ATBDR35151	
Marking						
Marking Tags	K Type		ATB2MT1			

Angled Spring-Clamp Ground Blocks

ASGMA22			ASGA4			ASGMA41			ASGMA42		
5 mm			6 mm			6 mm			6 mm		
42 x 54 mm			46 x 61.5 mm			46 x 61.5 mm			46 x 61.5 mm		
22-14 AWG			22-12 AWG			22-12 AWG			22-12 AWG		
9 mm			9 mm			9 mm			9 mm		
22-14 AWG	0.5-2.5 sq.mm	22-14 AWG	22-12 AWG	0.5-4 sq.mm	22-12 AWG	22-12 AWG	0.5-4 sq.mm	22-12 AWG	22-12 AWG	0.5-4 sq.mm	22-12 AWG
800 V			800 V			800 V			800 V		
24 A			32 A			32 A			32 A		
ATBDR351 ATBDR35151											
ASB2MT1			ASB4MT1								

BUS BAR TERMINAL BLOCKS

Bus bar terminal blocks are designed for applications involving high currents and large cable sizes, and are available for the wire range 8AWG to 4/0. Wires are crimped into ring type compression terminals and installed on the current bar of the terminal block.

End or partition insulation plates must be used with each block, and protective covers can be mounted in slots on the end plates.

Insulation Material: High Grade Melamine

Accessory and Marking Details: Pages 132-135

Standard Color: Beige

Alternate colors available as indicated below:

COLOR	SUFFIX
Blue	BU
Black	BK
Red	R
Yellow	Y

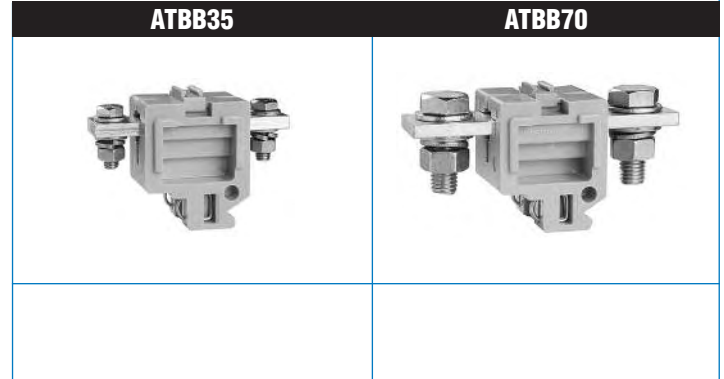

Specifications						
Pitch	28 mm		40 mm			
Height x Width	49 x 75 mm		49 x 98 mm			
Wire Range UL	8-2 AWG		8-2/0 AWG			
Strip Length/Bolt Size	20 mm/M6 x 20 mm		26 mm/M10 x 30 mm			
Ratings						
Rated Cross Section	8-2 AWG	16-35 sq.mm	8-2 AWG	8-2/0 AWG	35-70 sq.mm	8-2/0 AWG
Voltage Rating	600 V	1000 V	600 V	600 V	1000 V	600 V
Current Rating	145 A	125 A	145 A	250 A	192 A	250 A
Torque	27 lb-in	3.0 Nm	27 lb-in	87 lb-in	10.0 Nm	87 lb-in
Accessories						
INSULATION						
End/Partition Plate				ATBB35EP	ATBB35EP1	
Partition Plate (Polyamide 66)				ATBB35PP		
MOUNTING						
Mounting Rail (std. rail is 1.0 meters pre-slotted)				ATBDR321		
End Stop				ATB2EC1		
INTERCONNECTION						
Protective Cover	100 mm			ATBB35PC	ATBB35PC1	
	190 mm					
Marking						
Locating Support for ATBB35EP1				ATBB35EP2		

Bus Bar Terminal Blocks

ATBB95			ATBC35			ATBC70			ATBC95		
											
40 mm			28 mm			40 mm			40 mm		
49 x 130 mm			49 x 75 mm			49 x 98 mm			49 x 130 mm		
8-4/0 AWG			8-2 AWG			8-2/0 AWG			8-4/0 AWG		
26 mm/M10 x 30 mm			20 mm/M6x 20 mm			26 mm/M10 x 30 mm			26 mm/M10 x 30 mm		
 			 			 			 		
8-4/0 AWG	35-95 sq.mm	8-4/0 AWG	8-2 AWG	16-35 sq.mm	8-2 AWG	8-2/0 AWG	35-70 sq.mm	8-2/0 AWG	8-4/0 AWG	35-95 sq.mm	8-4/0 AWG
600 V	1000 V	600 V	600 V	1000 V	600 V	600 V	1000 V	600 V	600 V	1000 V	600 V
300 A	232 A	300 A	145 A	125 A	145 A	250 A	192 A	250 A	300 A	232 A	300 A
87 lb-in	10.0 Nm	87 lb-in	27 lb-in	3.0 Nm	27 lb-in	87 lb-in	10.0 Nm	87 lb-in	87 lb-in	10.0 Nm	87 lb-in
ATBB35EP1			ATBB35EP ATBB35EP1						ATBB35EP1		
			ATBB35PP								
			ATBDR321								
			ATB2EC1								
ATBB95PC ATBB95PC1			ATBB35PC ATBB35PC1						ATBB95PC ATBB95PC1		
			ATBB35EP2								

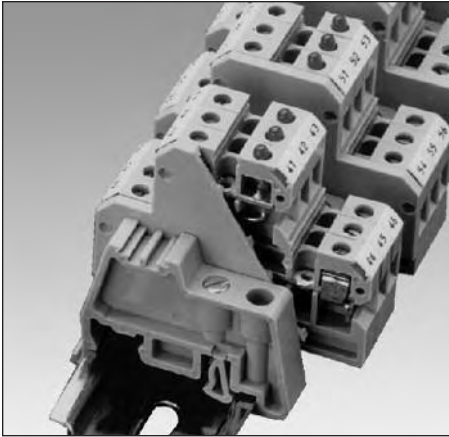

INSULATION

End Plate

End plates must be utilized to cover and electrically insulate the open portion of a terminal block in applications where it is not adjacent to another block. Normally, end plates are used as the final element (with the end stop) in a rail mount assembly; or at any place in the assembly when two blocks of different sizes are adjacent. Plates are provided in a variety of sizes and configurations, tailored to the block to be protected.

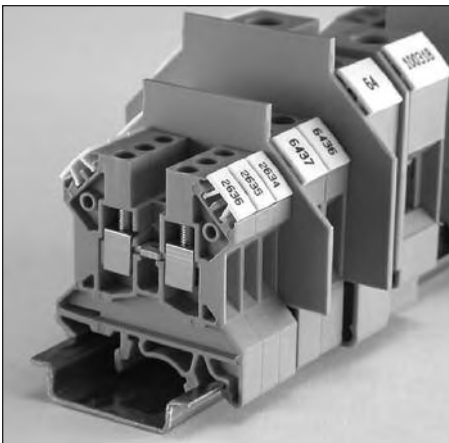

Partition Plates

Partition plates provide visual separation between groups of blocks in an assembly, and often function as a guide in identifying block functions and wiring the assembly.



Separator Plates

The Separator Plate provides electrical insulation between adjoining bus bars, and is only used in applications where bus bars are installed in adjacent terminal blocks. The plate eliminates the possibility of shorting between bus bars.

See catalog pages 102 - 130 for specific recommendations.

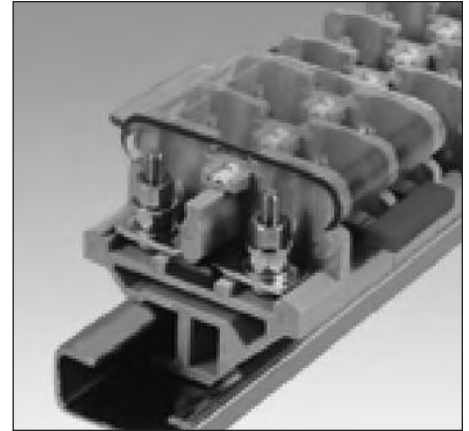

Protective Cover

Transparent safety covers snap over the tops of terminal blocks and provide additional insulation protection. Covers are available for stud mount and bus bar blocks, in two or three-position sizes, or in lengths of 1.0, 2.0 or 3.0 meters, to be cut to size.

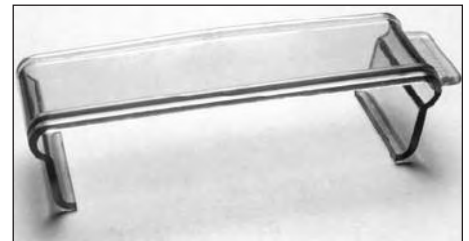

DIN TERMINAL BLOCKS Interconnecting/Bussing Accessories



INTERCONNECTION

Adjoining or non-adjoining terminal blocks can be connected together in a variety of ways:

Pre-Assembled Shorting Links

A pre-assembled bus bar which sits in a protective well in the top center of the terminal block, runs the length of the block group to be interconnected, and is electrically and mechanically connected to each block in the group by means of a secure screw connection. The bars are utilized in conjunction with threaded screw and spacer elements which clamp the bus bar directly to the current bar of the terminal block. Terminal blocks are included in the bussed group by utilizing the screw/spacer to connect them to the bus bar. Terminal blocks which are not part of the bussed group are simply not connected to the bus bar. Therefore, it is possible to create a bussed group which "bridges" certain blocks.

Links are available in both insulated and uninsulated designs, are supplied in 2-3-4 and 10 position lengths, and can be readily cut to desired length. See individual product pages for specific recommendations.

Side Jumper

An insulated "comb" side jumper which runs the length of the block group and locks into the wire holes can also be used. These jumpers are



also available in 2-3-4-10 position lengths, and can be readily cut to desired length and inserted into the wire entry hole. If it is desired to skip or "bridge" one or more blocks in a sequence, the appropriate contact elements can be removed. See product pages for specific recommendations.

Permanent Shorting Bars

Tin-plated copper/brass bus links, which rest below the top surface of the terminal blocks are used with sleeves and mounting screws to achieve a permanent cross connection. Bars are available in 2-3-4-10 position lengths, and may be cut to size. For switchable connections, two position removable shorting links are available. Sleeves and screws are ordered separately. Please contact Amphenol Pcd for ordering details.



Test Sockets

Test sockets are used for checking out circuits. The test socket screws into a tapped hole in the terminal block current bar, and accepts a standard test plug. Sockets can be left permanently in place, or only used as required. Contact Amphenol Pcd for specific recommendations.

Shorting Links for Spring Clamp Blocks

Insulated, two-position push-in links are utilized to bus adjacent spring clamp blocks on a track assembly. Alternate links perform the same function, but the contact spacing is designed for alternate (non-consecutive) blocks. Wired shorting links will connect any two blocks spaced up to ten positions apart. Recommendations in catalog.



Shorting links for Stud-Mount Blocks

Insulated and uninsulated links, permanent (ring tongue) and removable (fork tongue), available in 2-3-4 positions. Details on Stud-Mount Block product page.





Mounting Rails

Three basic mounting rail variations are available, as depicted above. Rails are steel, zinc chromate plated, and are supplied, pre-slotted, in 1.0 meter lengths. All rails are also available unslotted, and can be readily cut to desired length. Contact Amphenol Pcd regarding pre-cut rails.

ATBDR321 asymmetrical rail provides greater structural strength, and the asymmetrical shape ensures the directional alignment of blocks and eliminates installation errors. Meets European specification EN50035.

ATBDR35151 35x15 mm symmetrical rail is deep enough to readily accommodate mounting hardware. Meets European specification ENS500045.

ATBDR351 35x7.5 mm symmetrical rail is lighter in weight and is often spot-welded in place rather than



installed with hardware. Meets European specification EN50022.

With few exceptions, the terminal block variations depicted in this catalog will readily mount in all three basic track variations. The convenience, operating flexibility and inventory reduction provided by this feature is a key element of the rail mount terminal block system.

End Stops

Screw-actuated end stops clamp firmly to the rail, prevent lateral movement, and hold the terminal block assembly in place. End stops must be used at either end of a rail assembly.



ATB2EC1 stops are actuated vertically, and can be used with all rails.

ATB2EC2 stops feature angled actuation, and are for use with specific blocks mounted on ATBDR351 and ATBDR35151 rails, as indicated in the product pages.

Mounting Brackets

The ATBDRMB1 angled bracket allows rail to be mounted offset from the panel and at 45°. It simplifies access, particularly when the rail is at the bottom of a panel.

The ATBDRMB2/3/4 family of offset brackets provides a choice of panel clearance.

MARKING

All blocks are provided with recesses to accommodate marking tags, which snap into place. In almost all styles,

provisions are provided for at least two tags.

"K" style marking tags feature a large surface area, and are provided in strips of five to ten markers. Markers can be installed in strip form, or individually.

Marker recommendations on individual product pages are for unmarked tags. However, tags are available in



a wide variety of pre-printed styles, including sequential numbers, individual digits or letters, symbols, and varying orientations. Please contact Amphenol Pcd to discuss your marking needs.

Field Bus Interconnects Harsh Environment/Industrial Applications

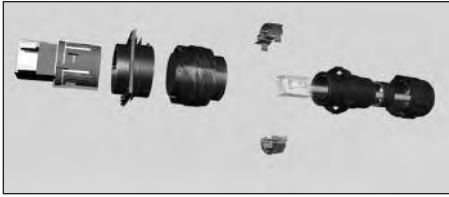

FIELD BUS INTERCONNECTS HARSH ENVIRONMENT/ INDUSTRIAL APPLICATIONS

The Field Bus Interconnect System allows users to quickly and reliably transform standard data and tele-communications cordsets into rugged, industrial connectors for harsh environments.

Featuring a variety of configurations – RJ45, Firewire, USB, and Fiber Optics – in many different formats, styles and plating, the Field Bus product line offers a solution for every situation. Connectors provide waterproof sealing against fluids and dust to meet IP67 requirements – waterproof under water up to one meter in depth, for up to an hour.



With the patented RJ Stop, solution, any standard data or communication cordset – including Ethernet, Firewire, USB and MTRJ, can be transformed into an environmentally protected connector in less than one minute, with no tooling or termination required.

RJ Field – Metal, Circular, RJ45 MIL-C-26482 Bayonet closure in Black, Nickel, or Green Cad.

RJ Field TV – Metal, Circular, RJ45 MIL-DTL-38999 Series III – Threaded closure in Nickel or Green Cad.

RJF 544 – Rugged, Black, Composite, Circular RJ45 Push-Pull coupling mechanism.



RJF EZ – Rugged, Black Composite, Rectangular Ethernet Lever coupling mechanism.

USB Field – Metal, Circular RJ45 MIL-DTL-38999 Series III – Threaded or Bayonet closure 1.1 or 2.0 versions.

Firewire Field – Metal, 2000a Circular RJ45 MIL-DTL-38999 Series III – Threaded coupling.

RJ Switch – Industrial, Ethernet Switch, IP67 – Metal or plastic enclosure, managed or unmanaged, to any configuration.



Typical applications include Process Control, Data Acquisition, Factory Automation, Video Control, Base Stations, Robotics, Rail & Mass Transit, Security and CCTV, Radar, Communications Systems and extreme Geophysical environments.

A broad line of accessories including caps with lanyards, Snap Caps, gaskets, backshells, metal glands and Cat5 or Cat5e high reliability cable is also available.



Amphenol Pcd



Компания «ЭлектроПласт» предлагает заключение долгосрочных отношений при поставках импортных электронных компонентов на взаимовыгодных условиях!

Наши преимущества:

- Оперативные поставки широкого спектра электронных компонентов отечественного и импортного производства напрямую от производителей и с крупнейших мировых складов;
- Поставка более 17-ти миллионов наименований электронных компонентов;
- Поставка сложных, дефицитных, либо снятых с производства позиций;
- Оперативные сроки поставки под заказ (от 5 рабочих дней);
- Экспресс доставка в любую точку России;
- Техническая поддержка проекта, помощь в подборе аналогов, поставка прототипов;
- Система менеджмента качества сертифицирована по Международному стандарту ISO 9001;
- Лицензия ФСБ на осуществление работ с использованием сведений, составляющих государственную тайну;
- Поставка специализированных компонентов (Xilinx, Altera, Analog Devices, Intersil, Interpoint, Microsemi, Aeroflex, Peregrine, Syfer, Eurofarad, Texas Instrument, Miteq, Cobham, E2V, MA-COM, Hittite, Mini-Circuits, General Dynamics и др.);

Помимо этого, одним из направлений компании «ЭлектроПласт» является направление «Источники питания». Мы предлагаем Вам помощь Конструкторского отдела:

- Подбор оптимального решения, техническое обоснование при выборе компонента;
- Подбор аналогов;
- Консультации по применению компонента;
- Поставка образцов и прототипов;
- Техническая поддержка проекта;
- Защита от снятия компонента с производства.



Как с нами связаться

Телефон: 8 (812) 309 58 32 (многоканальный)

Факс: 8 (812) 320-02-42

Электронная почта: org@eplast1.ru

Адрес: 198099, г. Санкт-Петербург, ул. Калинина, дом 2, корпус 4, литера А.