

# TLE9844-2QX Appkit Getting Started

September 2018



# Agenda

1

TLE9844-2QX Appkit overview

2

Product information and available documentation

3

How to install the toolchain

4

Set up your example project step by step

# Agenda

1

TLE9844-2QX Appkit overview

2

Product information and available documentation

3

How to install the toolchain

4

Set up your example project step by step

# Infineon Embedded Power ICs

## TLE9844-2QX Application Kit

### Infineon Embedded Power ICs Product Portfolio based on ARM® Cortex® M processor

#### Smart Relay IC DC Motor

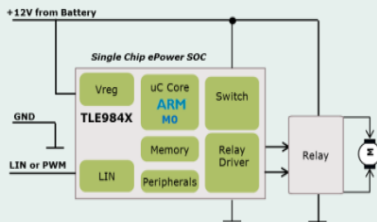

TLE9842/3/4

- > Window Lift
- > Sunroof
- > Wiper

#### Smart Half Bridge

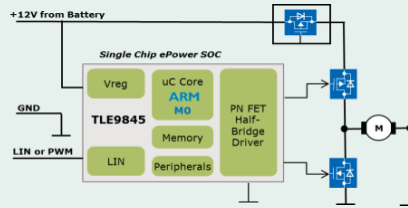

TLE9845

- > HVAC Fan
- > Engine Cooling Fan
- > Fuel Pump
- > Water Pump

#### Smart H-Bridge Driver

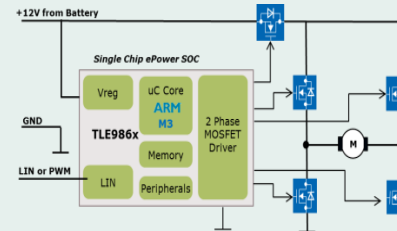

TLE986x

- > Window Lift
- > Sunroof
- > Wiper
- > Power Folding Roof
- > Power Sliding Door
- > Power trunk/  
tailgate

#### Smart BLDC Driver IC

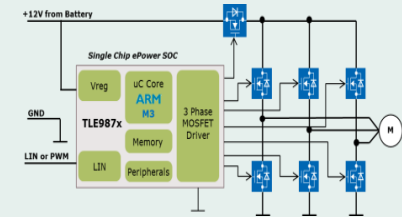

TLE987x

- > Fuel Pump
- > HVAC Fan
- > Engine Cooling Fan
- > Water Pump
- > Oil Pump
- > Sunroof
- > Wiper

# TLE9844-2QX Appkit

- › The TLE9844-2QX is part of our Embedded Power products and belongs to the relay driver IC family. The TLE9844-2QX Appkit is designed to evaluate relay driven DC Motor applications. The two layers PCB is space and cost optimized to demonstrate an application near solution.

## Target Applications

- › Automotive Body & Comfort applications such as sunroof and window lift

## Summary of Features

- › Automotive qualified relay driver IC (TLE9844-2QX) with integrated high-side switches
- › 2-channel relay
- › Onboard debug interface

# Infiniteon Embedded Power IC: TLE9844-2QX Application Board

## TLE9844-2QX Application Kit

- › Voltage supply: typ. 12 V
- › Motor current: max. 20 A
- › Infineon Relay Driver IC (ARM<sup>®</sup> Cortex<sup>®</sup> M0 MCU)
- › J-Link OB-Debugger with Serial COM Port
- › LIN Interface

TLE9844-2QX\_Appkit:  
**SP002235152**

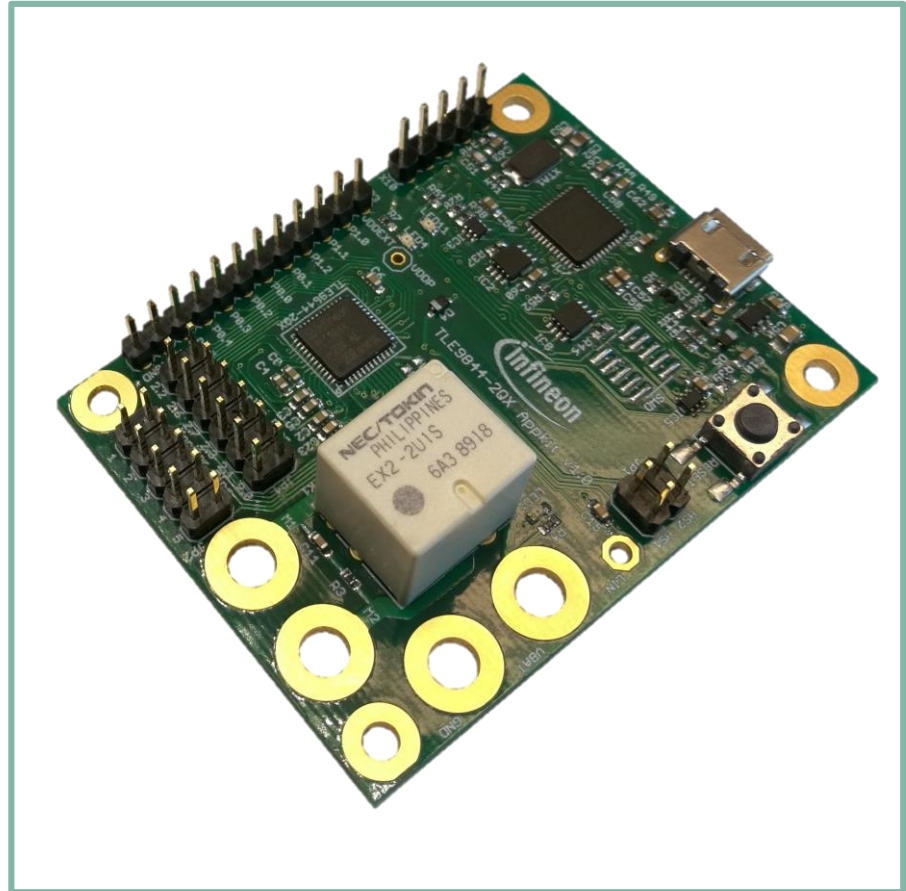

# Block diagram

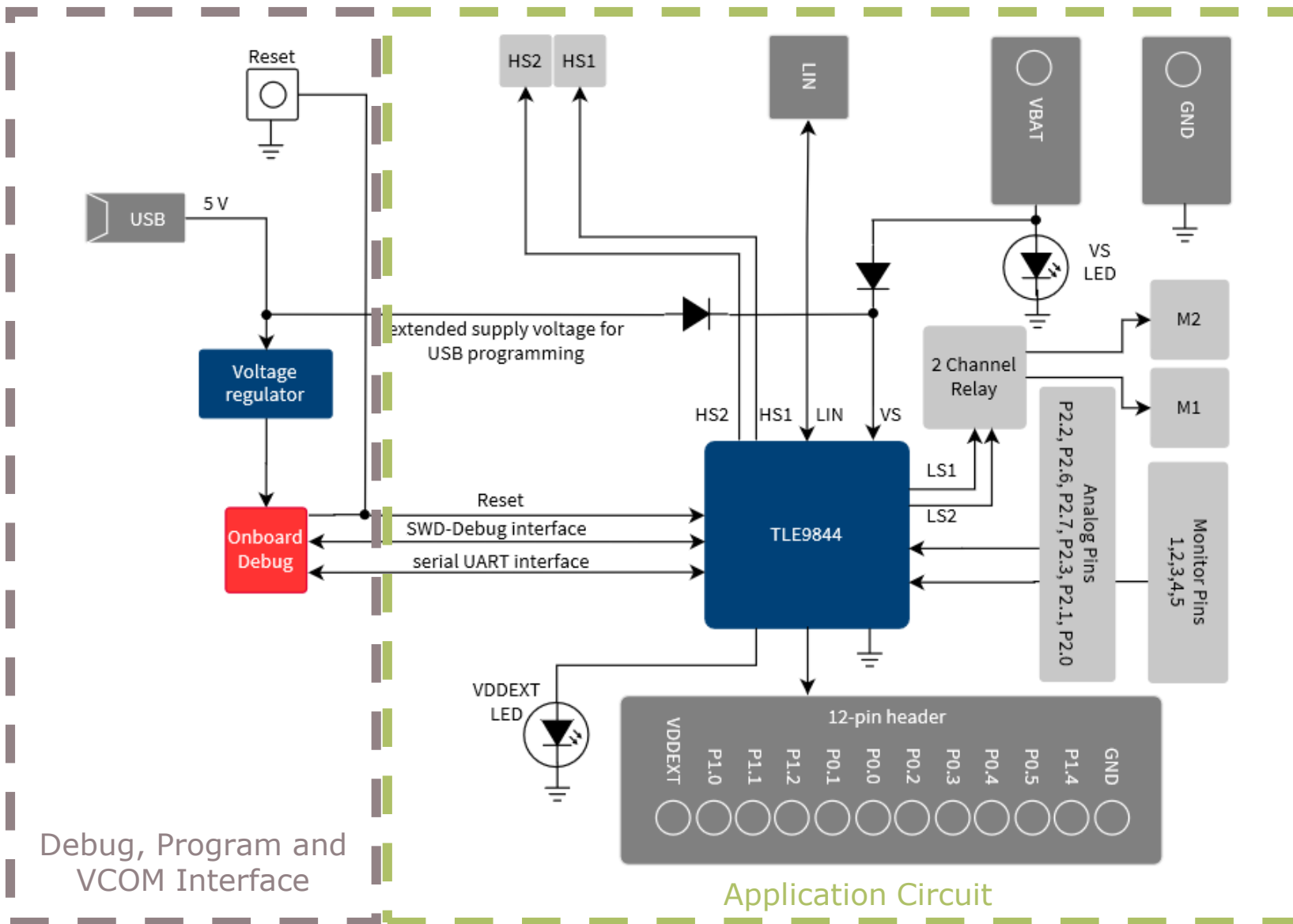

# Agenda

1

TLE9844-2QX Appkit overview

2

Product information and available documentation

3

How to install the toolchain

4

Set up your example project step by step



# Support for Relay Driver IC with Integrated ARM® Cortex® M0



## Collaterals and Brochures

- > Product Brief
- > Selection Guides
- > Product Presentations

## Technical Material

- > Datasheets
- > Application Notes
- > Getting Started
- > PCB Design Data
- > User Manuals
- > Layout Hints

## Evaluation Boards

- > Evaluation Boards
- > Application Kits

## Software & Tools

- > Config Wizard
- > Keil µVision5
- > Software Examples

## Videos

- > Technical Videos

> [Link to family page](#)

> [Link to Documents](#)

> [Link to board pages](#)

> [Link to Software & Tools](#)

> [Link to Videos](#)

# TLE9844-2QX Application Kit: Documentation



- › [User Manual for TLE9844-2QX](#)
- › [Application Note with Application Hints](#)
- › [Datasheet](#)

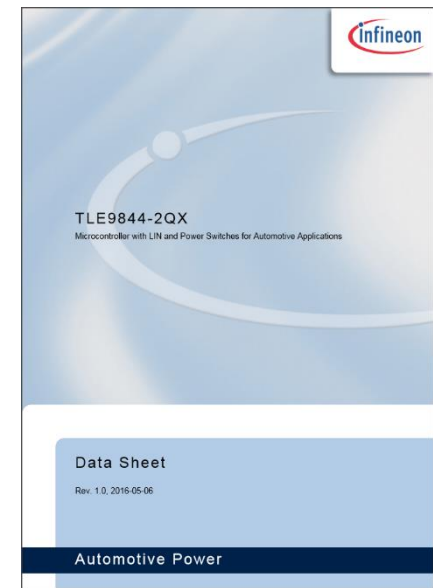
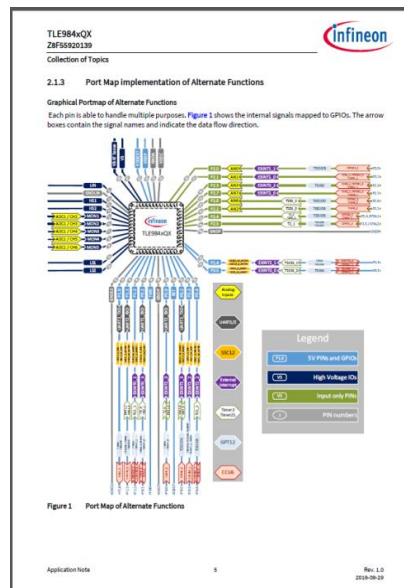

# Support Online tools and services



The screenshot shows the Infineon website with several elements highlighted by numbered callouts:

- 1**: Newsletter link in the top navigation bar.
- 2**: Where to Buy link in the top navigation bar.
- 3**: Tools link in the top navigation bar.
- 4**: Support link in the left sidebar navigation menu.

The main banner features a city skyline at night with the word "Lighting" and the text: "New LED controller enables low-wattage luminaire designs August 26th 17:00 CEST" and a "Register Now!" button.

The left sidebar navigation menu includes: Products, Applications, Tools, Support, and Technology.

The main content area lists various product categories under "Power":

- Power Overview
- Power MOSFET
- IGBT
- Smart Low-Side & High-Side Switches
- Linear Voltage Regulator
- DC-DC Converter
- LED Driver | Lighting ICs
- Silicon Carbide (SiC)
- High Power Thyristors & Diodes
- Motor Control & Gate Driver
- AC-DC Supply

- 1** Subscribe to Newsletter
- 2** Where to Buy
- 3** Tools, Finders and Selectors
- 4** Support

# Agenda

1

TLE9844-2QX Appkit overview

2

Product information and available documentation

3

How to install the toolchain

4

Set up your example project step by step

# Toolchain installation: General Overview

Infineon Embedded Power ICs are supported by a complete development tool chain provided by Infineon and third party vendors. The tool chain includes compilers, debuggers, evaluation boards, LIN low level drivers and configuration tools as well as variety of example software code.

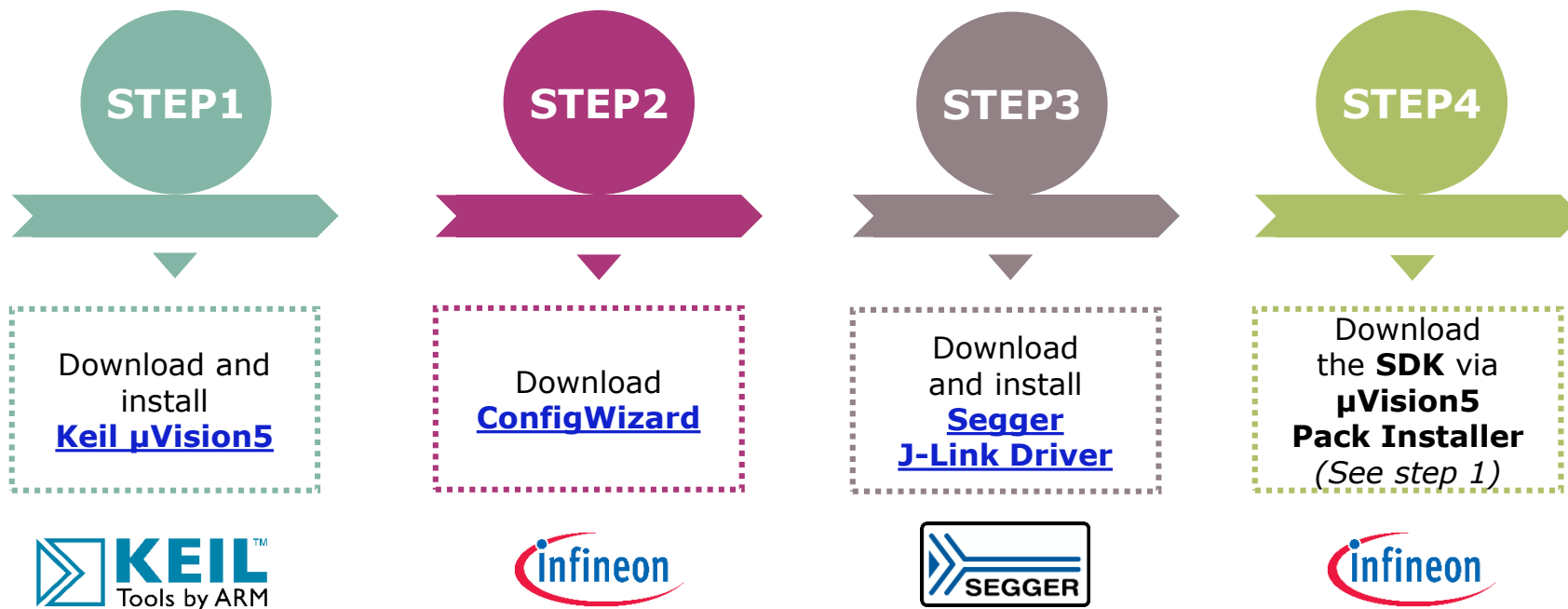

ARM Keil µVision is an integrated development environment which consists of code editor, compiler and debugger.

Infineon provides the ConfigWizard which is designed for configuration of chip modules. ConfigWizard supports easy configuring of Embedded Power peripherals.

SEGGER J-Link is a widely used driver for "on-board" or "stand-alone" debugger.

The Embedded Power Software Development Kit (SDK) is a low level driver library which can be downloaded within "Keil µVision" via the "Pack Installer".

# Toolchain installation: 1/4



## Keil μVision5

- > Code Editor & Online Debugger
- > Evaluation version can handle up to 32K

Download from:  
<https://www.keil.com/demo/eval/arm.htm>

## Main Window

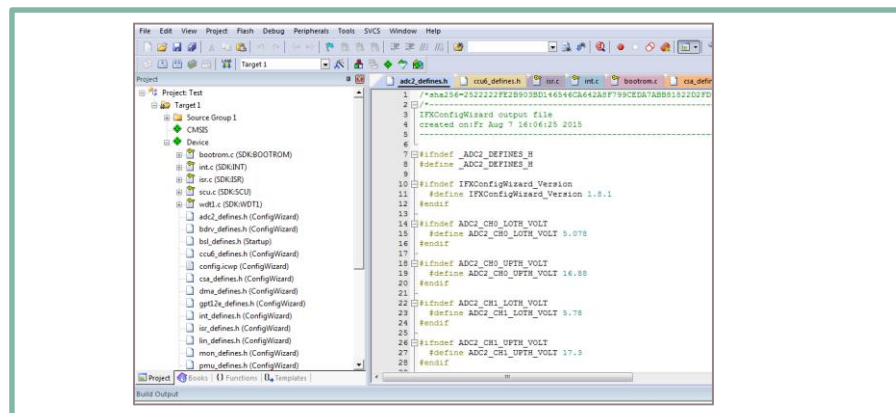

## Pack Installer

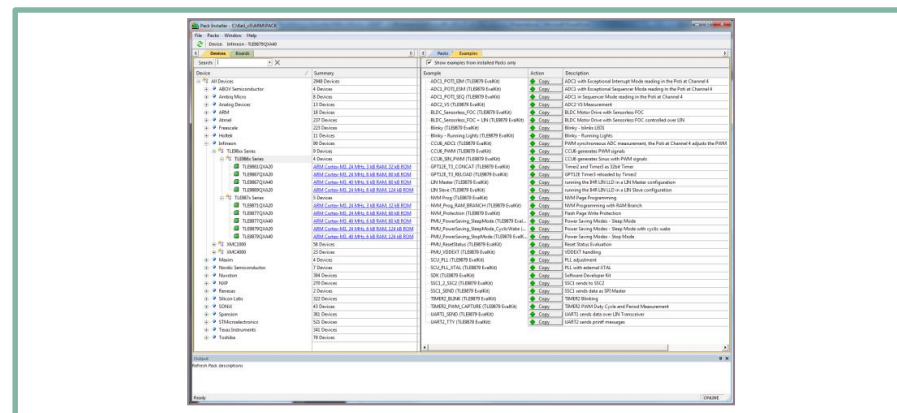

# Toolchain installation: 2/4



Infineon **ConfigWizard**

Configuration of chip modules

Infineon homepage: [ConfigWizard](#)

Latest version: V1.8.7

Device description for TLE984x included

TLE984x supported with Keil  $\mu$ Vision 5

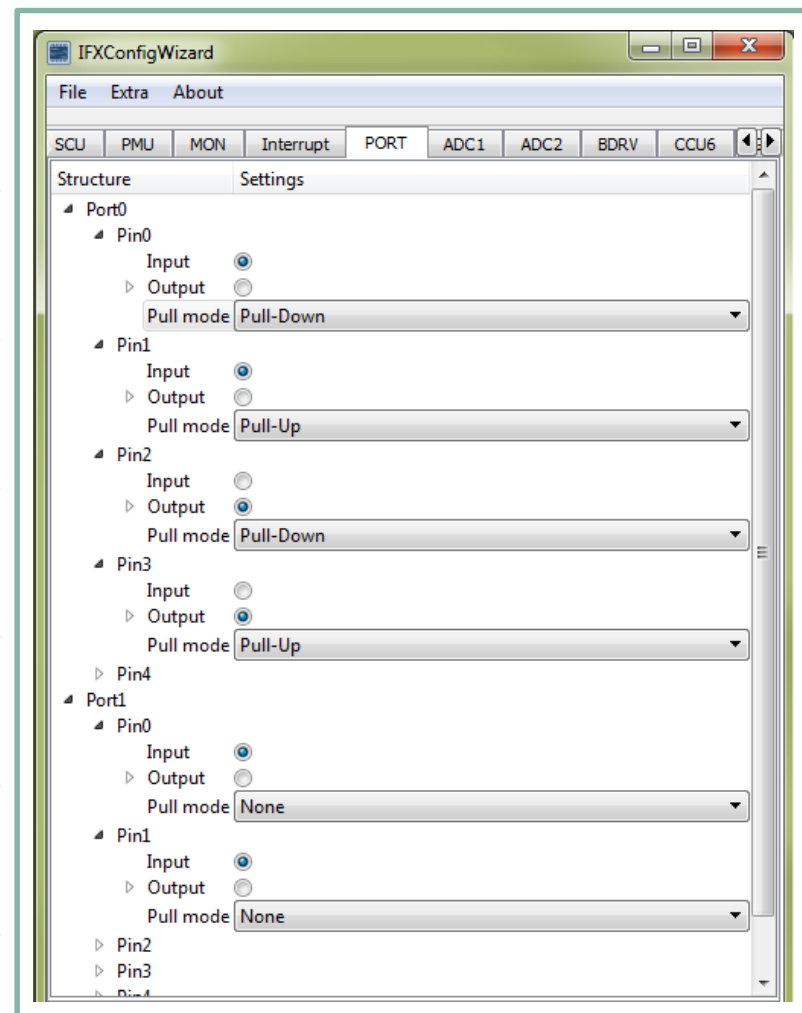

# Toolchain installation: 3/4



## Segger J-LINK-Lite driver:

- > Driver for 'on-board' or 'stand-alone' debugger
- > Install driver from: [https://www.segger.com/downloads/jlink/JLink\\_Windows.exe](https://www.segger.com/downloads/jlink/JLink_Windows.exe)
- > TLE9844-2QX support is included from V5.10 upwards

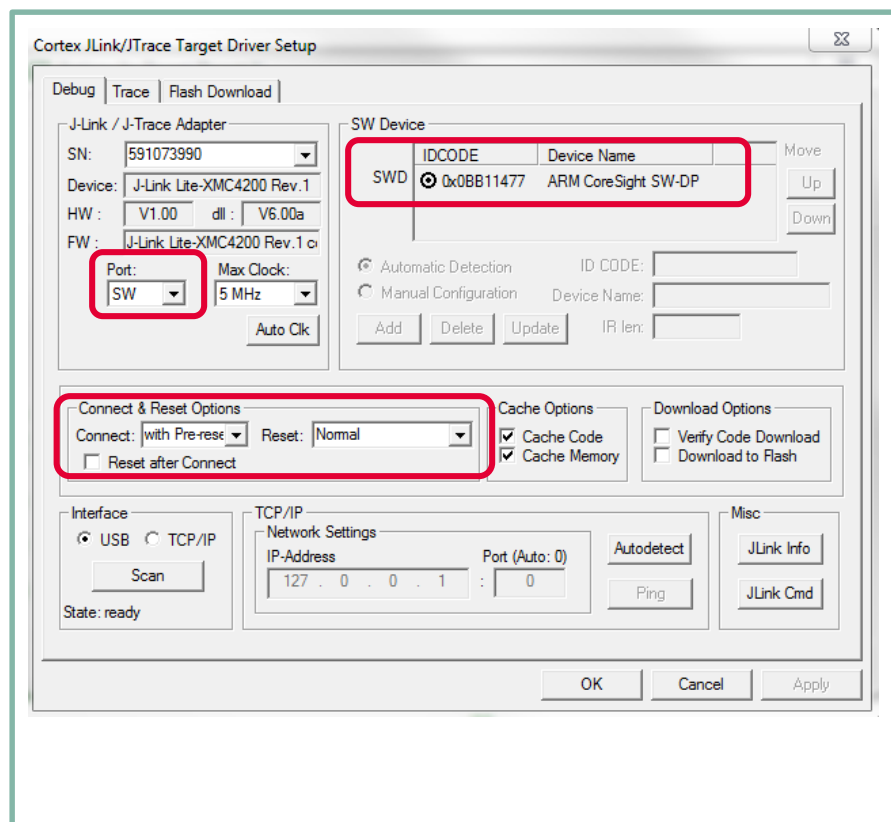



# Toolchain installation: 4/4



## PACK-file TLE984x for $\mu$ Vision5:

- > Device database for all TLE984x variants
- > Device support for flashing/erasing TLE984x
- > SFR description for register debugging
- > Device description for TLE984x for Config Wizard (XML)
- > Includes SDK (Software Development Kit)
- > Code examples included

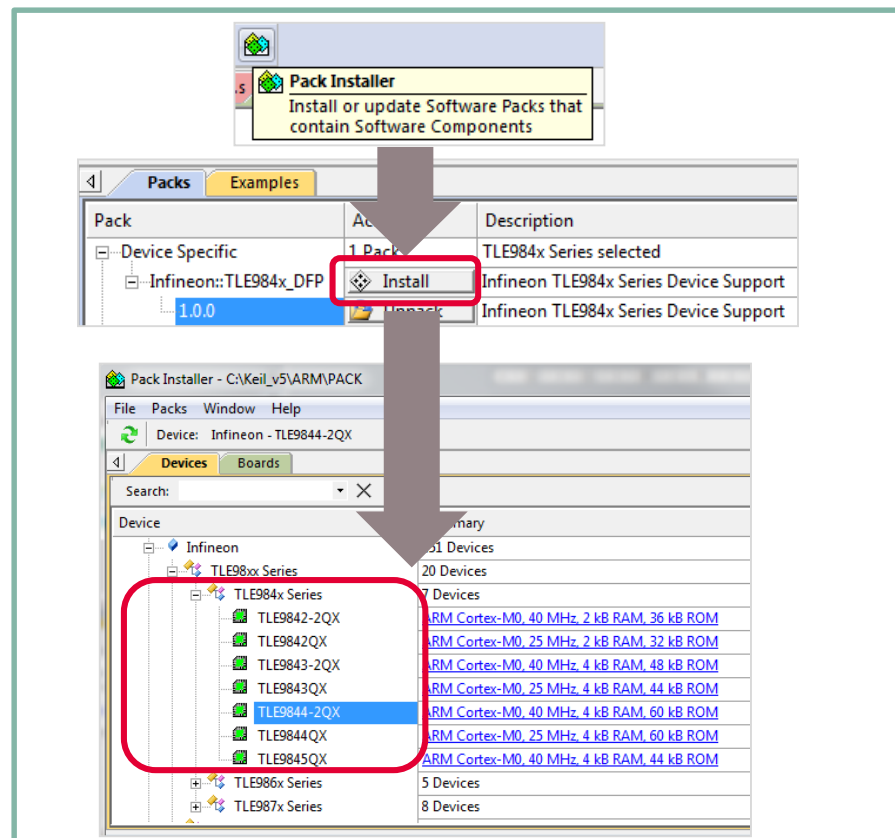

# Agenda

1

TLE9844-2QX Appkit overview

2

Product information and available documentation

3

How to install the toolchain

4

Set up your example project step by step

# Getting Started: How to create a new project

## 1) Create a new Project

- › Open Keil mdk
- › Go to → Project  
→ new  $\mu$ Vision Project
- › Name project: ('relay\_click')
- › Select Device:
  - › Infineon
    - › TLE98xx Series
      - › TLE984x Series
        - › TLE9844-2QX

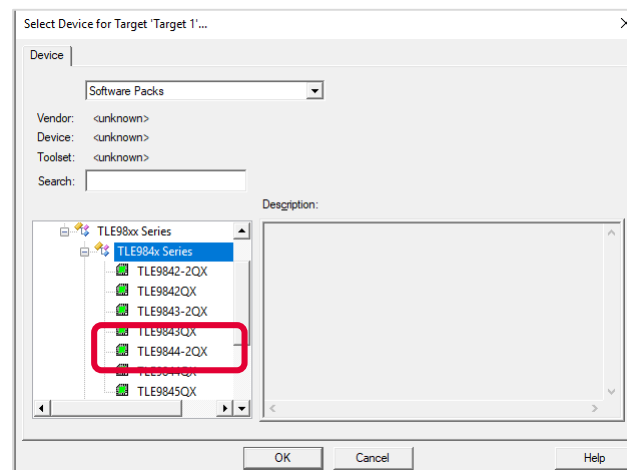
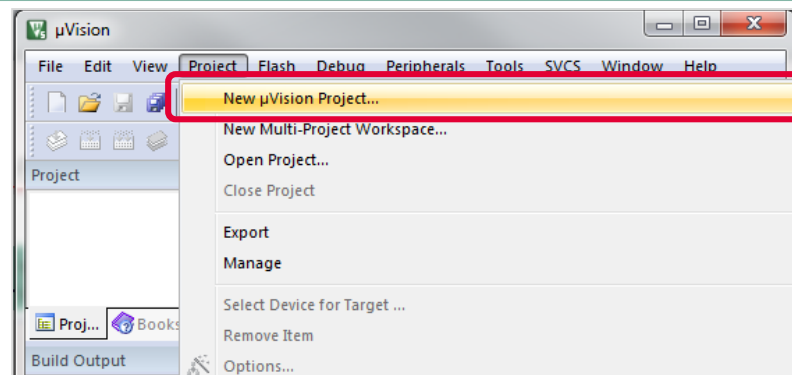

# Getting Started: How to configure your run-time environment

## 2) Configuration of Run-Time Environment

- › Expand: 'Device'
  - › Check: Startup
  - › Check: Config Wizard
- › 'Sel.' window background is **orange**
- › Press: 'Resolve'
- › 'Sel.' window background is now **green**
- › Expand 'SDK' and activate 'LS' Module



The image shows two screenshots of the 'Manage Run-Time Environment' dialog box. The top screenshot shows the 'Sel.' column with an orange background for the 'Startup' and 'ConfigWizard' rows. A red circle highlights the 'Resolve' button. The bottom screenshot shows the same dialog box after clicking 'Resolve', with the 'Sel.' column now having a green background for the 'Startup' and 'ConfigWizard' rows. A large grey arrow points from the 'Resolve' button in the top screenshot to the 'Startup' row in the bottom screenshot.

Software Component	Sel.	Variant	Version	Description
CMSIS				<a href="#">Cortex Microcontroller Software Interface Components</a>
CMSIS Driver				<a href="#">Unified Device Drivers compliant to CMSIS-Driver Specifications</a>
Compiler		ARM Compiler	1.4.0	<a href="#">Compiler Extensions for ARM Compiler 5 and ARM Compiler 6</a>
Device				<a href="#">Startup_System Setup</a>
Startup	<input checked="" type="checkbox"/>		1.0.1	System Startup for Infineon TLE984x device series
ConfigWizard	<input checked="" type="checkbox"/>		1.8.7	Infineon ConfigWizard Configuration File
SDK				
File System		MDK-Plus	6.10.0	<a href="#">File Access on various storage devices</a>
Graphics		MDK-Plus	5.46.5	<a href="#">User Interface on graphical LCD displays</a>
Network		MDK-Plus	7.8.0	<a href="#">IPv4 Networking using Ethernet or Serial protocols</a>
USB		MDK-Plus	6.12.4	<a href="#">USB Communication with various device classes</a>

Validation Output: Infineon::Device:Startup require Device:SDK:SCU  
Description: Additional software components required  
Select component from list  
Infineon::Device:SDK:SCU System Control Unit (SCU) driver for TLE984x

Buttons: Resolve, Select Packs, Details, OK, Cancel, Help

# Getting Started: Use standard templates

## 3) Using easy 'Main' template

1. Expand: 'Target 1'
2. Right click on: 'Source Group 1'
3. Choose: Add New Item to Group 'Source Group 1'
4. Choose 'User Code Template'
5. Expand 'Device'
6. Choose: 'Startup'
7. Continue with 'Add'

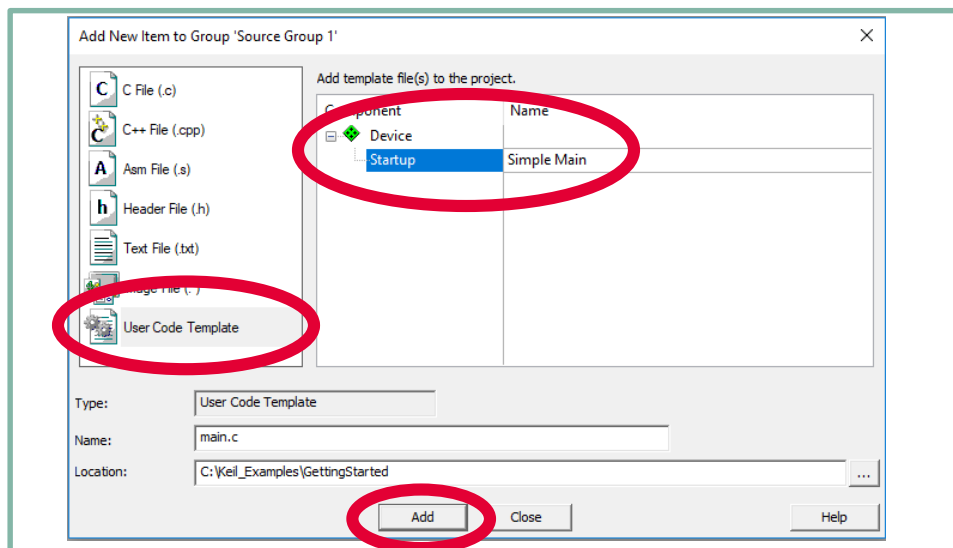
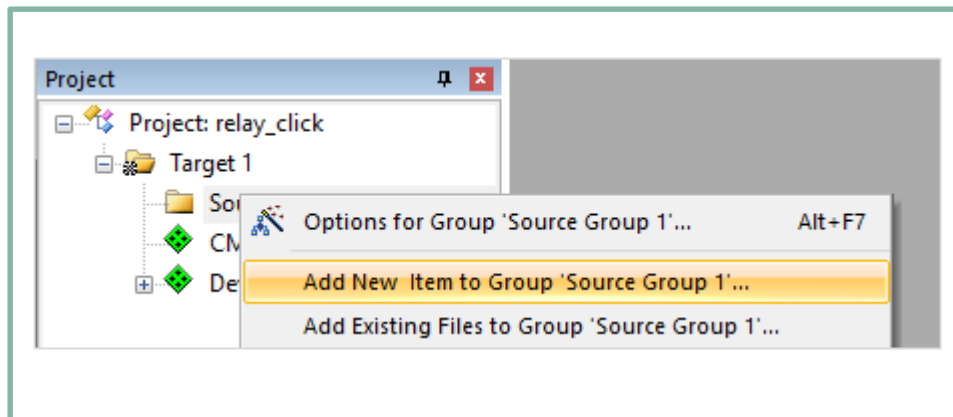

# Getting Started: How to use the Config Wizard

## 4a) Using Config Wizard

- > Open Config Wizard by choosing:  
'Tools → Config Wizard'
- > Config Wizard will open in a separate window
- > **orange** status bar indicates a new project
- > **red** status bar indicates unsaved changes
- > **white** status bar indicates saved project

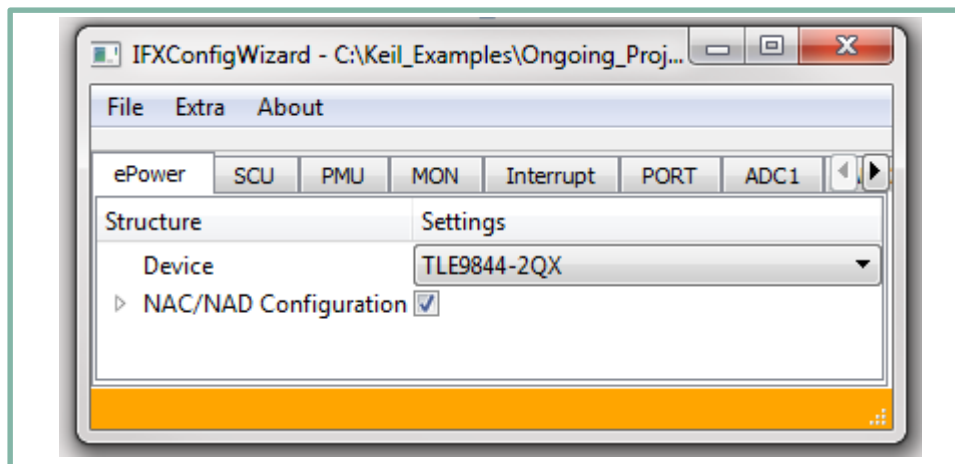
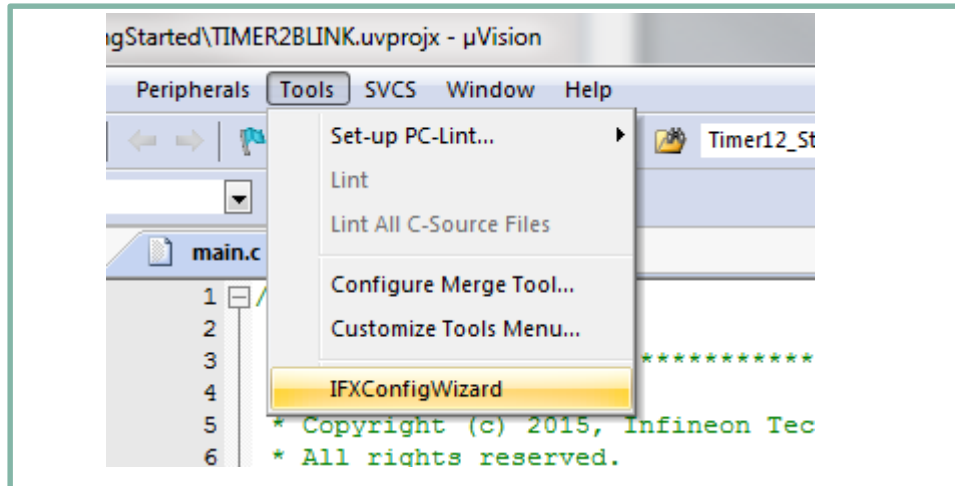

## 4b) Using Config Wizard: Low Side Switch Configuration

- › Select: 'LS' Chapter
  - › Enable 'LS1'
  - › Expand 'LS1'
  - › Expand 'Driver Settings'
  - › Check Low Side Driver ON
- 
- › Save with 'File' -> 'Save Project'
  - › After Saving, status bar turns to **white** color

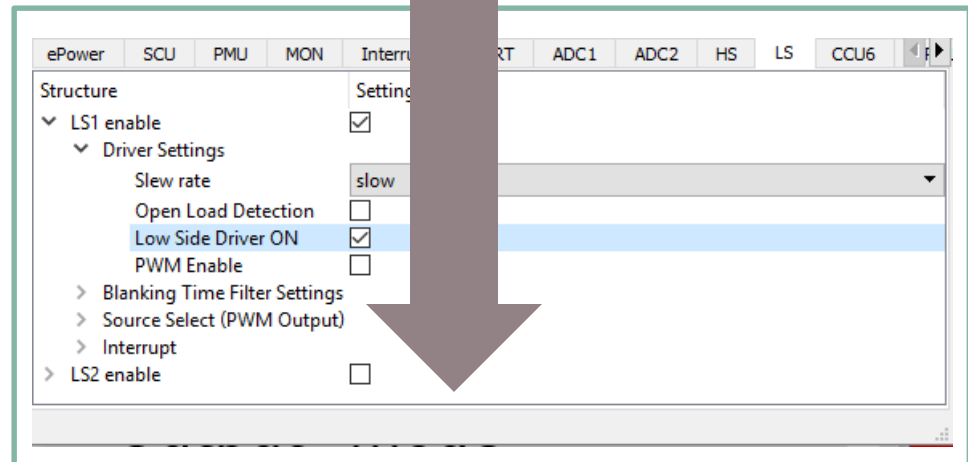
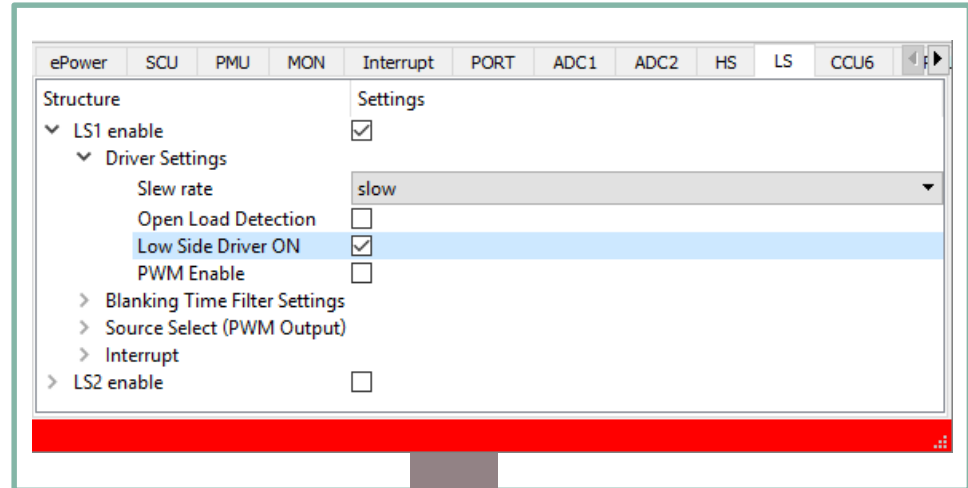

# Getting Started: How to compile your projects

## 4) Compile Project

- > Compile Project:
  - > Press "Build" Button or press "F7"
- > Project "Build Output" window shows  
0 Error(s) , 0 Warning(s)

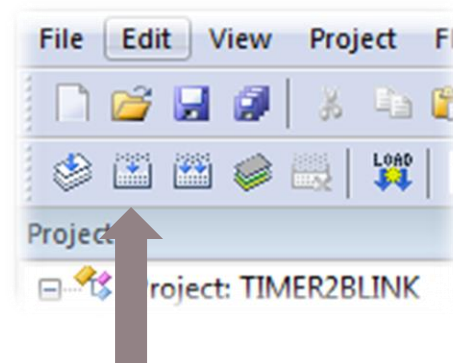

```

Build Output
compiling main.c...
compiling port.c...
compiling timer2x.c...
linking...
Program Size: Code=1512 RO-data=164 RW-data=16 ZI-data=608
".\Objects\Getting_Started.axf" - 0 Error(s), 0 Warning(s).
Build Time Elapsed: 00:00:02
    
```



# Getting Started: Power up your board and connect the debugger

## 6) Power up Evaluation board

- › Connect micro USB cable
- › Supply board via 12V power supply (VBAT, GND)
- › Debug LED and VBAT LED light up

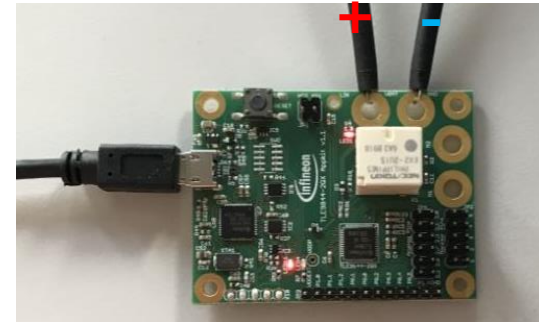

## 7) Connect Debugger

- › Go to
- › Choose:
  - › Debug->use: J-Link
  - › Go to Settings
- › SWD connection established when 'IDCODE' is visible

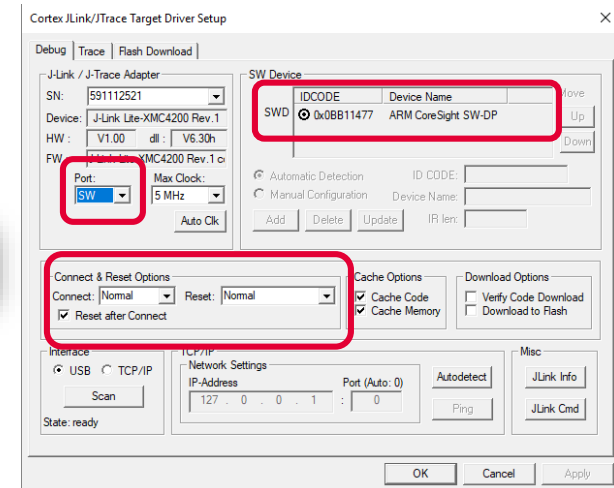

# Getting Started: How to download and run your code

## 8) Download and run code

- › Press: 'Load'- button or Press: 'F8'
- › 'Flash Load finished' is shown in 'Build Output' window

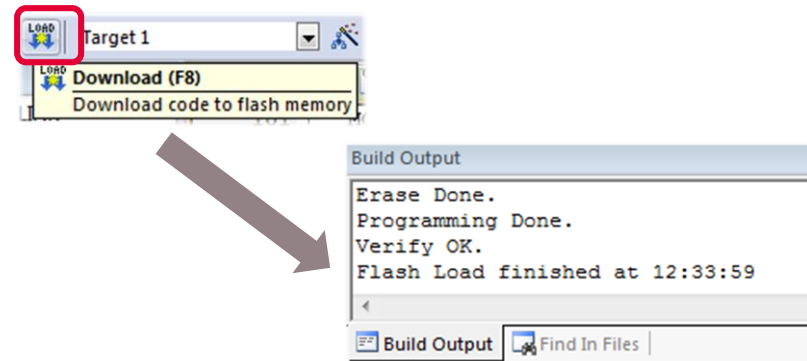

- › Press: 'Reset' button on Application Kit
- › LS1 activate first relay coil
- › Ticking noise occur

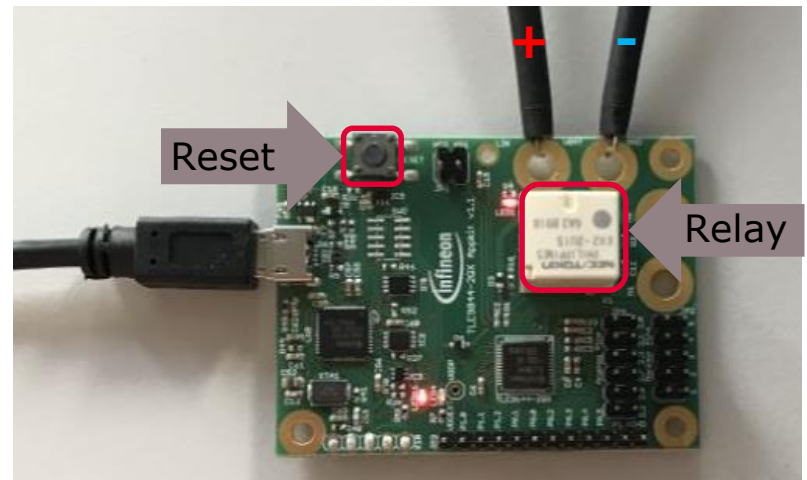

# Getting Started: Available example code

## Infineon Example Code available in "Pack Installer"

The screenshot displays the Pack Installer application window. The left pane shows a tree view of device packs, with the Infineon TLE9879QXA40 selected. The right pane shows a list of example code snippets available for this device, each with a 'Copy' action button and a description.

Example	Action	Description
-ADC1_POTI_EIM (TLE9879 EvalKit)	Copy	ADC1 with Exceptional Interrupt Mode reading in the Poti at Channel 4
-ADC1_POTI_ESM (TLE9879 EvalKit)	Copy	ADC1 with Exceptional Sequencer Mode reading in the Poti at Channel 4
-ADC1_POTI_SEQ (TLE9879 EvalKit)	Copy	ADC1 in Sequencer Mode reading in the Poti at Channel 4
-ADC2_VS (TLE9879 EvalKit)	Copy	ADC2 VS Measurement
BLDC_Block_Commutation_HALL (TLE9879 E...	Copy	BLDC Motor Drive with Block Commutation with HALL Sensor
BLDC_Block_Commutation_HALL + LIN (TLE...	Copy	BLDC Motor Drive with Block Commutation with HALL Sensor controlled over LIN
BLDC_Sensorless_FOC (TLE9879 EvalKit)	Copy	BLDC Motor Drive with Sensorless FOC
BLDC_Sensorless_FOC + LIN (TLE9879 EvalKit)	Copy	BLDC Motor Drive with Sensorless FOC controlled over LIN
Blinky (TLE9879 EvalKit)	Copy	Blinky - blinks LED1
Blinky - Running Lights (TLE9879 EvalKit)	Copy	Blinky - Running Lights
CCU6_ADC1 (TLE9879 EvalKit)	Copy	PWM synchronous ADC measurement, the Poti at Channel 4 adjusts the PWM
CCU6_PWM (TLE9879 EvalKit)	Copy	CCU6 generates PWM signals
CCU6_SIN_PWM (TLE9879 EvalKit)	Copy	CCU6 generates Sinus with PWM signals
DMA ADC1 Sequence (TLE9879 EvalKit)	Copy	ADC1 triggers DMA after sequence is done
DMA SPI (TLE9879 EvalKit)	Copy	Sends data through SPI using DMA
DMA UART TTY (TLE9879 EvalKit)	Copy	UART2 sends data triggered by DMA
GPT12E_T3_CONCAT (TLE9879 EvalKit)	Copy	Timer2 and Timer3 as 32bit Timer
GPT12E_T3_RELOAD (TLE9879 EvalKit)	Copy	GPT12E Timer3 reloaded by Timer2
LIN Master (TLE9879 EvalKit)	Copy	running the IHR LIN LLD in a LIN Master configuration
LIN Slave (TLE9879 EvalKit)	Copy	running the IHR LIN LLD in a LIN Slave configuration
PMU_Data_Flash_Handling (TLE9879 EvalKit)	Copy	NVM Data Flash page write with error handling
NVM_Prog (TLE9879 EvalKit)	Copy	NVM Page Programming
NVM_Prog_RAM_BRANCH (TLE9879 EvalKit)	Copy	NVM Programming with RAM Branch
NVM_Protection (TLE9879 EvalKit)	Copy	Flash Page Write Protection
PMU_PowerSaving_SleepMode (TLE9879 Eval...	Copy	Power Saving Modes - Sleep Mode
PMU_PowerSaving_SleepMode_CyclicWake (...)	Copy	Power Saving Modes - Sleep Mode with cyclic wake
PMU_PowerSaving_StopMode (TLE9879 EvalK...	Copy	Power Saving Modes - Stop Mode
PMU_ResetStatus (TLE9879 EvalKit)	Copy	PMU Reset Status Evaluation
PMU_VDDEXT (TLE9879 EvalKit)	Copy	VDDEXT handling
SCU_PLL (TLE9879 EvalKit)	Copy	PLL adjustment
SCU_PLL_XTAL (TLE9879 EvalKit)	Copy	PLL with external XTAL
SDK (TLE9879 EvalKit)	Copy	Software Developer Kit
SSC1_2_SSC2 (TLE9879 EvalKit)	Copy	SSC1 sends to SSC2
SSC1_SEND (TLE9879 EvalKit)	Copy	SSC1 sends data as SPI Master
TIMER2_BLINK (TLE9879 EvalKit)	Copy	TIMER2 Blinking
TIMER2_PWM_CAPTURE (TLE9879 EvalKit)	Copy	TIMER2 PWM Duty Cycle and Period Measurement
UART1_SEND (TLE9879 EvalKit)	Copy	UART1 sends data over LIN Transceiver
UART2_TTY (TLE9879 EvalKit)	Copy	UART2 sends printf messages



Part of your life. Part of tomorrow.





Компания «ЭлектроПласт» предлагает заключение долгосрочных отношений при поставках импортных электронных компонентов на взаимовыгодных условиях!

Наши преимущества:

- Оперативные поставки широкого спектра электронных компонентов отечественного и импортного производства напрямую от производителей и с крупнейших мировых складов;
- Поставка более 17-ти миллионов наименований электронных компонентов;
- Поставка сложных, дефицитных, либо снятых с производства позиций;
- Оперативные сроки поставки под заказ (от 5 рабочих дней);
- Экспресс доставка в любую точку России;
- Техническая поддержка проекта, помощь в подборе аналогов, поставка прототипов;
- Система менеджмента качества сертифицирована по Международному стандарту ISO 9001;
- Лицензия ФСБ на осуществление работ с использованием сведений, составляющих государственную тайну;
- Поставка специализированных компонентов (Xilinx, Altera, Analog Devices, Intersil, Interpoint, Microsemi, Aeroflex, Peregrine, Syfer, Eurofarad, Texas Instrument, Miteq, Cobham, E2V, MA-COM, Hittite, Mini-Circuits, General Dynamics и др.);

Помимо этого, одним из направлений компании «ЭлектроПласт» является направление «Источники питания». Мы предлагаем Вам помощь Конструкторского отдела:

- Подбор оптимального решения, техническое обоснование при выборе компонента;
- Подбор аналогов;
- Консультации по применению компонента;
- Поставка образцов и прототипов;
- Техническая поддержка проекта;
- Защита от снятия компонента с производства.



#### Как с нами связаться

**Телефон:** 8 (812) 309 58 32 (многоканальный)

**Факс:** 8 (812) 320-02-42

**Электронная почта:** [org@eplast1.ru](mailto:org@eplast1.ru)

**Адрес:** 198099, г. Санкт-Петербург, ул. Калинина, дом 2, корпус 4, литера А.