

Snap Action Switch SS

Subminiature Snap Action Switch

- Economical, subminiature snap action switch offers long service life (30 million operations minimum)
- All models are free from overtravel restrictions, permit easy setting
- Wide switching capacity range from microvoltage/current loads (1 mA at 5 VDC to high-capacity loads 10.1 A at 250 VAC)
- Standard operating force, low force or super-low force models available
- RoHS Compliant



Ordering Information

Rating	Actuator	Contact OF	PCB terminal			Soldered terminal	Tab (#110) terminal
			Straight	Left-angled	Right-angled		
0.1 A	Pin plunger 	25 g	SS-01-ED	—	—	SS-01-E	SS-01-ET
		50 g	SS-01-FD	—	—	SS-01-F	SS-01-FT
		150 g	SS-01D	SS-01D1	SS-01D2	SS-01	SS-01T
	Hinge lever 	8 g	SS-01GL-ED	—	—	SS-01GL-E	SS-01GL-ET
		16 g	SS-01GL-FD	—	—	SS-01GL-F	SS-01GL-FT
		50 g	SS-01GLD	SS-01GLD1	SS-01GLD2	SS-01GL	SS-01GLT
	Simulated roller lever 	8 g	SS-01GL13-ED	—	—	SS-01GL13-E	SS-01GL13-ET
		16 g	SS-01GL13-FD	—	—	SS-01GL13-F	SS-01GL13-FT
		50 g	SS-01GL13D	—	—	SS-01GL13	SS-01GL13T
	Hinged roller lever 	8 g	SS-01GL2-ED	—	—	SS-01GL2-E	SS-01GL2-ET
		16 g	SS-01GL2-FD	—	—	SS-01GL2-F	SS-01GL2-FT
		50 g	SS-01GL2D	—	—	SS-01GL2	SS-01GL2T
5 A	Pin plunger 	50 g	SS-5-FD	SS-5-FD1	SS-5-FD2	SS-5-F	SS-5-FT
		150 g	SS-5D	SS-5D1	SS-5D2	SS-5	SS-5T
	Hinge lever 	16 g	SS-5GL-FD	SS-5GL-FD1	SS-5GL-FD2	SS-5GL-F	SS-5GL-FT
		50 g	SS-5GLD	SS-5GLD1	SS-5GLD2	SS-5GL	SS-5GLT
	Simulated roller lever 	16 g	SS-5GL13-FD	—	SS-5GL13-FD2	SS-5GL13-F	SS-5GL13-FT
		50 g	SS-5GL13D	SS-5GL13D1	SS-5GL13D2	SS-5GL13	SS-5GL13T
	Hinge roller lever 	16 g	SS-5GL2-FD	SS-5GL2-FD1	SS-5GL2-FD2	SS-5GL2-F	SS-5GL2-FT
		50 g	SS-5GL2D	SS-5GL2D1	SS-5GL2D2	SS-5GL2	SS-5GL2T
10 A	Pin plunger 	150 g	SS-10D	—	—	SS-10	SS-10T
	Hinge lever 	50 g	SS-10GLD	—	—	SS-10GL	SS-10GLT
	Simulated roller lever 	50 g	SS-10GL13D	—	—	SS-10GL13	SS-10GL13T
	Hinge roller lever 	50 g	SS-10GL2D	—	—	SS-10GL2	SS-10GL2T

Model Number Legend

SS-□□□□□
1 2 3 4 5

1. Ratings

10: 10.1 A at 125 VAC
5: 5 A at 125 VAC
01: 0.1 A at 30 VDC

2. Actuator

None: Pin plunger
GL: Hinge lever
GL13: Simulated roller lever
GL2: Hinge roller lever

3. Maximum Operating Force (see note)

None: 150 gf
-F: 50 gf (0.1A and 5A versions)
-E: 25 gf (0.1A versions)

4. Contact Form

None: SPDT
-2: SPST-NC
-3: SPST-NO

5. Terminals

None: Solder terminals
T: Quick-connect terminals (#110)
D: Straight PCB terminals
D1: Left-angled PCB terminals
D2: Right-angled PCB terminals

Note: These OF values are for the pin plunger models.
Consult Omron regarding the following:
- SPST-NC and SPST-NO versions
- High temperature versions that are rated from -25°C to 120°C
- Left and Right angled PCB terminal versions

Specifications

■ Characteristics

Operating speed	0.1 mm to 1 m/second (pin plunger models)
Operating frequency	Mechanical: 400 operations per minute max. Electrical: 30 operations per minute max.
Insulation resistance	100 MΩ at 500 VDC
Contact resistance	150 gf: SS-10, SS-5 models: 30 mΩ max. SS-01 models: 50 mΩ max. 50 gf: SS-5 models: 50 mΩ max. SS-01 models: 100 mΩ max. 25 gf: SS-01 models: 150 mΩ max.
Dielectric strength (See note 2)	1,000 VAC (600 VAC for SS-01), 50/60 Hz for 1 minute between terminals of same polarity 1,500 VAC, 50/60 Hz for 1 minute between current-carrying metal parts and ground and between each terminal and noncurrent-carrying metal parts
Vibration resistance (see note 3)	Malfunction: 10 to 55 Hz, 1.5 mm double amplitude
Shock resistance (see note 3)	150 gf: Destruction: 1,000 m/s ² (approx. 100G) max. Malfunction: 300 m/s ² (approx. 30G) max. 50 gf and 25gf: Destruction: 500 m/s ² (approx. 50G) max. Malfunction: 200 m/s ² (approx. 20G) max.
Degree of protection	IEC IP40
Degree of protection against electric shock	Class I
Proof tracking index (PTI)	175
Ambient operating temperature	-25° to 85°C (at 60% RH max.) with no icing
Ambient operating humidity	85% max. (for 5°C to 35°C)
Service life	Mechanical: 30 million operations min. at 60 operations per minute (SS-01, SS-5) 10 million operations min. at 60 operations per minute (SS-10) Electrical: 200,000 operations min. at 30 operations per minute (SS-01, SS-5) 50,000 operations min. at 30 operations per minute (SS-10)
Weight	Approx. 1.6 g pin plunger type

Note: 1. Data shown are of initial value.

2. The dielectric strength values shown is measured using a separator between the switch and metal mounting plate.

3. For pin plunger models, the above value apply for use at the free position and total travel position. For the lever models, the values apply at the total travel position.

■ Ratings (reference values)

Switch series:	SS-10 and SS-5								SS-01	
	Resistive load		Lamp load		Inductive load		Motor load		Resistive Load	
	NC	NO	NC	NO	NC	NO	NC	NO	NC	NO
125 VAC	5 A (10.1A)		1.5 A	0.7 A	3 A		2.5 A	1.3 A	0.1 A	
250 VAC	3 A (10.1A)		1 A	0.5 A	2 A		1.5 A	0.8 A	---	
8 VDC	5 A (10.1A)		2 A		5 A	4 A	3 A		0.1 A	
14 VDC	5 A (10.1A)		2 A		4 A		3 A		0.1 A	
30 VDC	4 A		2 A		3 A		3 A		0.1 A	
125 VDC	0.4 A		0.05 A		0.4 A		0.05 A		---	
250 VDC	0.2 A		0.03 A		0.2 A		0.03 A		---	

- Note:**
1. Data in parentheses apply to the SS-10 models only.
 2. The above current ratings are the values of the steady-state current.
 3. Inductive load has a power factor of 0.4 min. (AC) and a time constant of 7 ms max. (DC). The inductive load rating of the SS-10 is the same as that of SS-5.
 4. Lamp load has an inrush current of 10 times the steady-state current
 5. Motor load has an inrush current of 6 times the steady-state current.
 6. If the switch is used in a DC circuit and is subjected to inrush current or surge, connect a surge suppressor across the switch.
 7. The electrical rating applies under the following test conditions:
Ambient Temperature = 20±2°C, Ambient Humidity = 65±5%, Operating frequency = 30 operations/minute

■ Approved Standards

UL Recognized (File No. E41515)
CSA Certified (File No. LR21642)

Rated Voltage	SS-10	SS-5	SS-01
125 VAC	---	5 A	0.1 A
250 VAC	10.1 A	3 A	---
30 VDC	---	---	0.1 A

EN61058-1 - - VDE approval
(File No. 129246 for SS-5, 125256 for SS-10)

Rated Voltage	SS-10	SS-5
250 VAC	10.1 A	5 A

EN61058-1 - - TÜV Rheinland approval
(File No. J9451450)

Rated Voltage	SS-10	SS-5
250 VAC	10.1 A	5 A

Testing conditions: 5E4 (50,000 operations), T85 (0°C to 85°C)

Note: The rated values approved by each of the safety standards (e.g. UL, CSA) may be different from the performance characteristics individually defined in this catalog.

■ Contact Specifications

Item	SS-10	SS-5	SS-01
Specification	Rivet		Crossbar
Material	Silver alloy	Silver	Gold alloy
Gap (standard value)	0.5 mm		0.25 mm
Inrush current	NC: 20A max. NO: 15A max.	NC: 20A max. NO: 10A max.	1A max.
Minimum applicable load (see note)	160 mA at 5 VDC		1 mA at 5 VDC

Note: Minimum applicable loads are indicated by N standard reference values. This value represents the failure rate at a 60% (λ_{60}) reliability level (JIS C5003).
The equation $\lambda_{60}=0.5 \times 10^{-6} / \text{operations}$ indicates that a failure rate of 1/2,000,000 operations can be expected at a reliability level of 60%

Engineering Data

Mechanical Service Life

SS-01, SS-5 Models
(Pin Plunger Models)

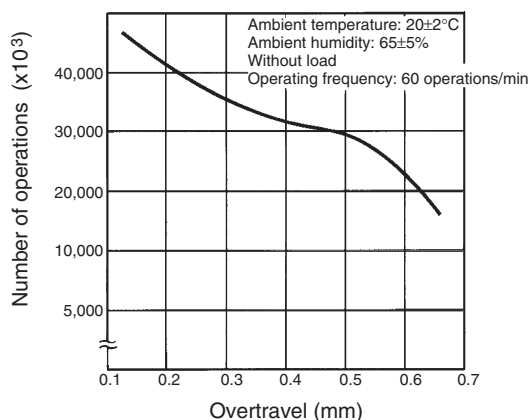

Electrical Service Life

SS-5 Models
(Pin Plunger Models)

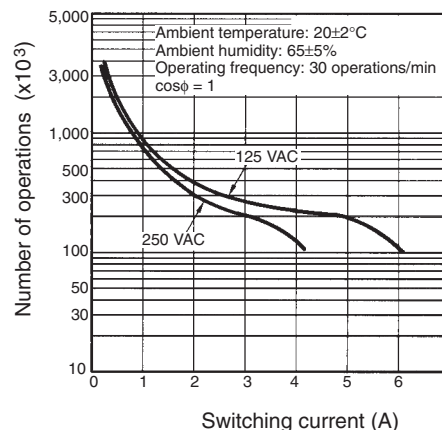

Mounting

Panel Mounting

All switches may be panel mounted using M2.3 mounting screws with plane washers or spring washers to securely mount the switch. Tighten the screws to a torque of 0.23 to 0.26 N·m.

Two, 2.4-dia. mounting holes or M2.3 screw holes

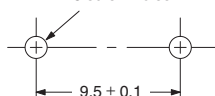

PCB Layout

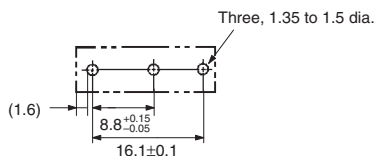

Contact Form

SPDT

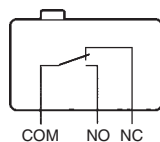

SPST-NC

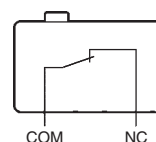

SPST-NO

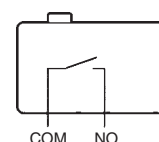

* Consult Omron for SPST-NC and SPST-NO contact form types ordering information.

Dimensions

■ Terminals

- Note:** 1. Unless otherwise specified, all units are in millimeters and a tolerance of ± 0.4 mm applies to all dimensions
 2. Terminal plate thickness is 0.5 mm for all models.

Solder Terminals

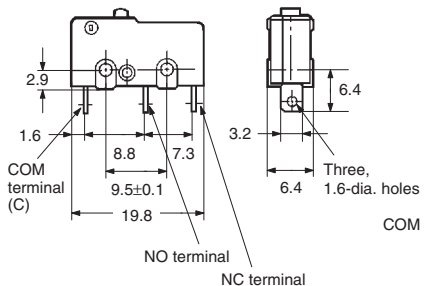

Quick-connect Terminals (#110)



PCB Terminals



Note: Terminal plate thickness is 0.5 mm for all models.

PCB, Left-angled terminal



PCB, Right-angled terminal



Note: Angled terminal directions are shown below.



■ Dimensions and Operating Characteristics

- Note:** 1. Unless otherwise specified, all units are in millimeters and a tolerance of ± 0.4 mm applies to all dimensions
 2. The following illustrations and dimensions are for solder terminal models. Refer to "Terminals" for models with quick-connect terminals (#110) or PCB terminals.
 3. The operating characteristics are for operation in the A direction (↓)

Pin Plunger Models

SS-01(-E, -F)
 SS-5(-F)
 SS-10

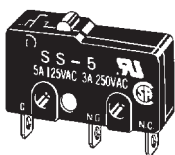

Characteristics	Part number			
	SS-01-E	SS-01-F, SS-5-F	SS-01, SS-5	SS-10
OF max.	25 g	50 g	150 g	150 g
RF min.	2 g	4 g	25 g	25 g
PT max.	0.5 mm	0.5 mm	0.5 mm	0.6 mm
OT min.	0.5 mm	0.5 mm	0.5 mm	0.4 mm
MD max.	0.1 mm	0.1 mm	0.1 mm	0.12 mm
OP	8.4 ± 0.5 mm			

Hinge Lever Models

SS-01GL(-E, -F)
SS-5GL(-F)
SS-10GL

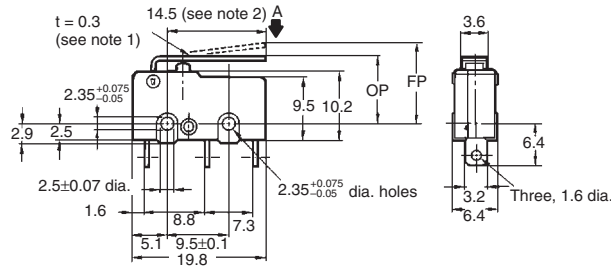
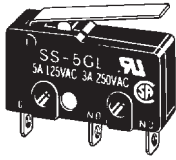

- Note:**
1. Stainless-steel lever
 2. Besides the SS-□GL models with a hinge lever length of 14.5, the SS-□GL11 models with a hinge lever length of 18.5, the SS-□GL111 models with a hinge lever length of 22.6, and the SS-□GL1111 models with a hinge lever length of 37.8 are available. Contact your OMRON representative for these models

Characteristics	SS-01GL-E	SS-01GL-F, SS-5GL-F	SS-01GL, SS-5GL	SS-10GL
OF max.	8 g	16 g	50 g	50 g
RF min.	1 g	2 g	6 g	6 g
OT min.	1.2 mm	1.2 mm	1.2 mm	1.0 mm
MD max.	0.8 mm	0.8 mm	0.8 mm	1.0 mm
FP max.	13.6 mm			
OP	8.8 ± 0.8 mm			

Simulated Roller Lever Models

SS-01GL13(-E, -F)
SS-5GL13(-F)
SS-10GL13

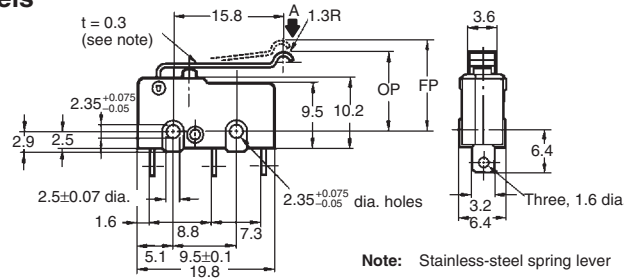
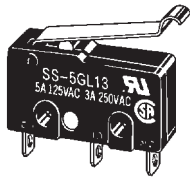

Note: Stainless-steel spring lever

Characteristics	SS-10GL13-E	SS-10GL13-F, SS-5GL13-F	SS-01GL13, SS-5GL13	SS-10GL13
OF max.	8 g	16 g	50 g	50 g
RF min.	1 g	2 g	6 g	6 g
OT min.	1.2 mm	1.2 mm	1.2 mm	1.0 mm
MD max.	0.8 mm	0.8 mm	0.8 mm	1.0 mm
FP max.	15.5 mm			
OP	10.7±0.8 mm			

Hinge Roller Lever Models

SS-01GL2(-E, -F)
SS-5GL2(-F)
SS-10GL2

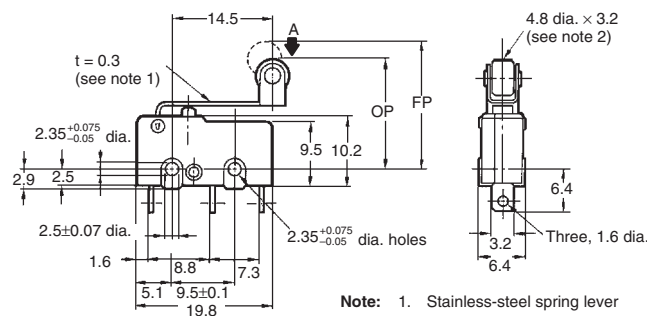
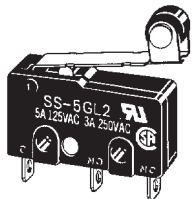

- Note:**
1. Stainless-steel spring lever
 2. Polyacetal resin roller

Characteristics	SS-01GL2-E	SS-01GL2-F, SS-5GL2-F	SS-01GL2, SS-5GL2	SS-10GL2
OF max.	8 g	16 g	50 g	50 g
RF min.	1 g	2 g	6 g	6 g
OT min.	1.2 mm	1.2 mm	1.2 mm	1.0 mm
MD max.	0.8 mm	0.8 mm	0.8 mm	1.0 mm
FP max.	19.3 mm			
OP	14.5 ± 0.8 mm			

Precautions

Be sure to read the precautions and information common to all Snap Action and Detection Switches, contained in the Technical User's Guide, "Snap Action Switches, Technical Information" for correct use.

Correct Use

Mounting

Mount the switch onto a flat surface. Mounting on an uneven surface may cause deformation of the switch, resulting in faulty operation or breakage in the housing.

Operating Stroke

Take particular care in setting the operating stroke for the pin plunger models. Make sure that the operating stroke is 70% to 100% of the rated OT distance. Do not operate the actuator exceeding the OT distance, otherwise the life expectancy of the switch may be shortened.

Using Microloads

Using a model for ordinary loads to switch microloads may result in faulty operation. Instead, use the models that are designed for microloads and that operate in the following range;

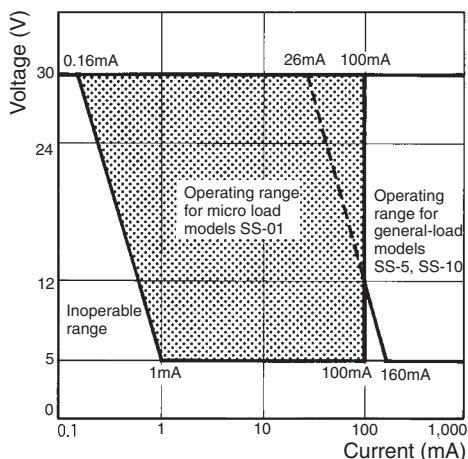

However, even when using microload models within the operating range shown above, if inrush current or inductive voltage spikes occur when the contact is opened or closed, then contact wear may increase and so decrease the service life. Therefore, insert a contact protection circuit where necessary.

Cautions

Handling

Turn OFF the power supply before mounting or removing the switch, wiring, or performing maintenance for inspection. Failure to do so may result in electric shock or burning

Terminal Connection

When soldering the lead wire to the terminal, first insert the lead wire conductor through the terminal hole and then solder.

Make sure that the capacity of the soldering iron is 60 W maximum. Do not take more than 5 seconds to solder the switch terminal. Improper soldering involving an excessively high temperature or excessive soldering time may deteriorate the characteristics of the switch.

Be sure to apply only the minimum required amount of flux. The switch may have contact failures if flux intrudes in the interior of the switch.

Use the following lead wires to connect to the solder terminals;

Model	Conductor size
SS-5	0.5 to 0.75 mm ²
SS-10	0.75 mm ²

If the PCB terminal models are soldered in a solder bath, flux will permeate inside the switch and cause contact failure. Therefore, manually solder the PCB terminal.

Wire the quick-connect terminals (#110) with receptacles. Insert the terminals straight into the receptacles. Do not impose excessive force on the terminal in the horizontal direction, otherwise the terminal may be deformed or the housing may be damaged.

Insulation Distance

Use a separator between the switch and metal mounting panels, to ensure proper dielectric characteristics are achieved.

According to EN61058-1, the minimum insulation thickness for this switch should be 1.1 mm and minimum clearance distance between the terminal and mounting plate should be 1.6 mm. If the insulation distance cannot be provided in the product incorporating the switch, either use a switch with insulation barrier or use a separator to ensure sufficient insulation distance.

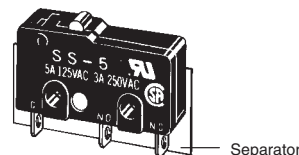

All sales are subject to Omron Electronic Components LLC standard terms and conditions of sale, which can be found at http://www.components.omron.com/components/web/webfiles.nsf/sales_terms.html

ALL DIMENSIONS SHOWN ARE IN MILLIMETERS.
To convert millimeters into inches, multiply by 0.03937. To convert grams into ounces, multiply by 0.03527.

OMRON[®]
**OMRON ELECTRONIC
COMPONENTS LLC**
55 E. Commerce Drive, Suite B
Schaumburg, IL 60173
847-882-2288

OMRON ON-LINE
Global - <http://www.omron.com>
USA - <http://www.components.omron.com>

Cat. No. X303-E-1

11/10

Specifications subject to change without notice

Printed in USA



Компания «ЭлектроПласт» предлагает заключение долгосрочных отношений при поставках импортных электронных компонентов на взаимовыгодных условиях!

Наши преимущества:

- Оперативные поставки широкого спектра электронных компонентов отечественного и импортного производства напрямую от производителей и с крупнейших мировых складов;
- Поставка более 17-ти миллионов наименований электронных компонентов;
- Поставка сложных, дефицитных, либо снятых с производства позиций;
- Оперативные сроки поставки под заказ (от 5 рабочих дней);
- Экспресс доставка в любую точку России;
- Техническая поддержка проекта, помощь в подборе аналогов, поставка прототипов;
- Система менеджмента качества сертифицирована по Международному стандарту ISO 9001;
- Лицензия ФСБ на осуществление работ с использованием сведений, составляющих государственную тайну;
- Поставка специализированных компонентов (Xilinx, Altera, Analog Devices, Intersil, Interpoint, Microsemi, Aeroflex, Peregrine, Syfer, Eurofarad, Texas Instrument, Miteq, Cobham, E2V, MA-COM, Hittite, Mini-Circuits, General Dynamics и др.);

Помимо этого, одним из направлений компании «ЭлектроПласт» является направление «Источники питания». Мы предлагаем Вам помощь Конструкторского отдела:

- Подбор оптимального решения, техническое обоснование при выборе компонента;
- Подбор аналогов;
- Консультации по применению компонента;
- Поставка образцов и прототипов;
- Техническая поддержка проекта;
- Защита от снятия компонента с производства.



Как с нами связаться

Телефон: 8 (812) 309 58 32 (многоканальный)

Факс: 8 (812) 320-02-42

Электронная почта: org@eplast1.ru

Адрес: 198099, г. Санкт-Петербург, ул. Калинина, дом 2, корпус 4, литера А.