

TCS30DPU

1. Functional Description

- Digital-Output Magnetic Sensor

2. Features

- (1) Output configuration: Push-pull
- (2) Pole detected: South or north pole

3. Packaging

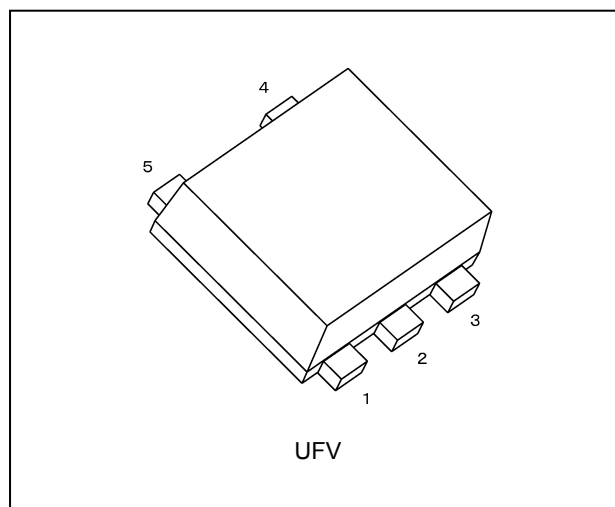

4. Marking and Pin Assignment

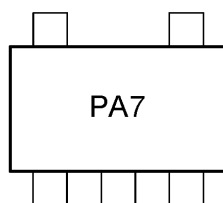

Marking

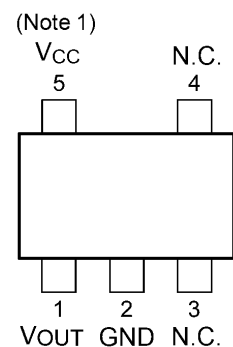

Pin Assignment (top view)

Note 1: A 0.47 μ F capacitor should be connected near the device.

However, this does not guarantee proper operation.

Evaluate the performance of an actual application to determine circuit conditions.

5. Function Table

Magnetic Flux Density	Output
$\geq B_{ON}$	L
$\leq B_{OFF}$	H

Start of commercial production

2017-06

6. Absolute Maximum Ratings (Note) (Unless otherwise specified, $T_a = 25\text{ }^\circ\text{C}$)

Characteristics	Symbol	Rating	Unit
Supply voltage	V_{CC}	-0.5 to 6.0	V
Output voltage	V_{OUT}	-0.5 to 6.0	V
Output diode current	I_{OK}	± 10	mA
Output current	I_{OUT}	± 5	mA
V_{CC}/GND current	I_{CC}	± 10	mA
Power dissipation	P_D	200	mW
Storage temperature	T_{stg}	-65 to 150	$^\circ\text{C}$

Note: Using continuously under heavy loads (e.g. the application of high temperature/current/voltage and the significant change in temperature, etc.) may cause this product to decrease in the reliability significantly even if the operating conditions (i.e. operating temperature/current/voltage, etc.) are within the absolute maximum ratings.

Please design the appropriate reliability upon reviewing the Toshiba Semiconductor Reliability Handbook ("Handling Precautions"/"Derating Concept and Methods") and individual reliability data (i.e. reliability test report and estimated failure rate, etc).

7. Operating Range

Characteristics	Symbol	Rating	Unit
Supply voltage	V_{CC}	2.3 to 3.6	V
Output voltage	V_{OUT}	0 to V_{CC}	V
Output current	I_{OH}, I_{OL}	± 1.0	mA
Operating temperature	T_{opr}	-40 to 85	$^\circ\text{C}$

8. Electrical Characteristics

8.1. DC Characteristics (Unless otherwise specified, $T_a = 25\text{ }^\circ\text{C}$)

Characteristics	Symbol	Note	Test Condition	V_{CC} (V)	Min	Typ.	Max	Unit
High-level output voltage	V_{OH}		$I_{OH} = -1.0\text{ mA}$	2.3 to 3.6	$V_{CC} \times 90\%$	—	—	V
Low-level output voltage	V_{OL}		$I_{OL} = 1.0\text{ mA}$	2.3 to 3.6	—	—	$V_{CC} \times 10\%$	V
Average current (intermittent)	$I_{CC(AVE)}$	(Note 1)	See Fig. 8.1.1.	2.3 to 2.7	—	8.5	13.2	μA
				3.0 to 3.6	—	12.4	18.3	
Operating current (intermittent)	$I_{CC(ON)}$	(Note 1)	See Fig. 8.1.1.	2.3 to 3.6	—	0.7	1.3	mA
Operating frequency	f_{opr}		See Fig. 8.1.1.	2.3 to 3.6	—	25	—	Hz

Note 1: The supply current is pulsed periodically by internal circuitry.

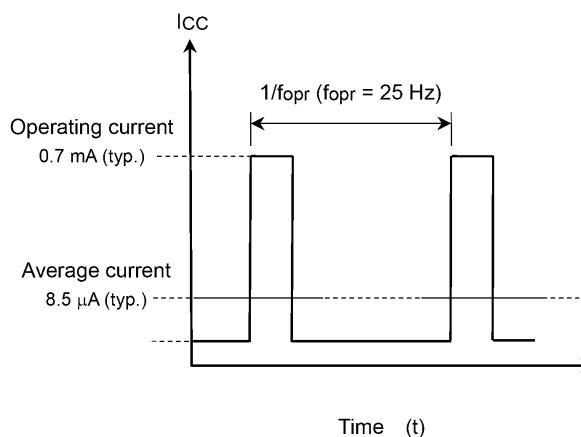

Fig. 8.1.1 I_{CC} Characteristics During Intermittent Operation

8.2. Magnetic Characteristics (Note) (Unless otherwise specified, $T_a = 25\text{ }^\circ\text{C}$)

Characteristics	Symbol	Test Condition	V_{CC} (V)	Min	Typ.	Max	Unit
South pole operating magnetic flux density	B_{ONS}	$V_{OUT} = V_{OL}$ See Fig. 8.2.1, 8.2.2.	2.3 to 3.6	—	1.8	2.5	mT
North pole operating magnetic flux density	B_{ONN}			-2.5	-1.8	—	
South pole operating magnetic flux density	B_{OFFS}	$V_{OUT} = V_{OH}$ See Fig. 8.2.1, 8.2.2.	2.3 to 3.6	0.3	0.8	—	mT
North pole operating magnetic flux density	B_{OFFN}			—	-0.8	-0.3	
Hysteresis magnetic flux density	B_H	$ B_{ON} - B_{OFF} $ See Fig. 8.2.1, 8.2.2.	2.3 to 3.6	—	1.0	—	mT

Note: Uniform magnetic field perpendicular to the magnetic sensor.

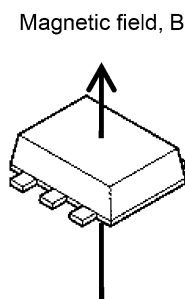

Fig. 8.2.1 Magnetic Field Direction

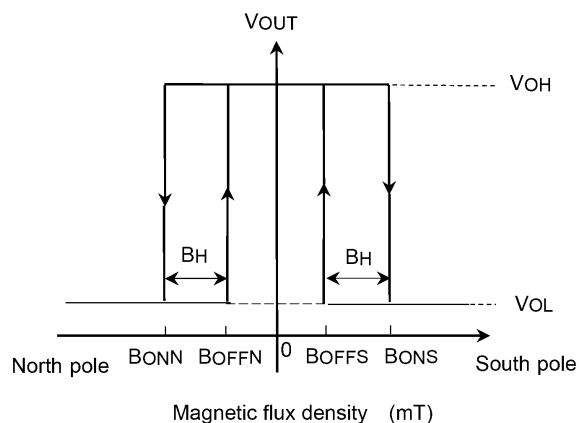
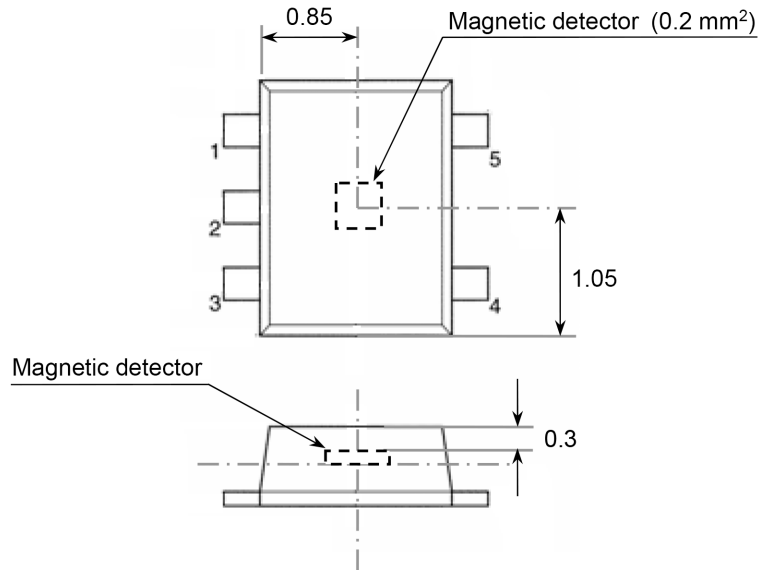

Fig. 8.2.2 Operating Characteristics

9. Magnetic Detector Layout (Note)

Unit: mm



Note: Dimensional tolerances are ± 0.1 mm, unless otherwise specified.

Package Dimensions

Unit: mm

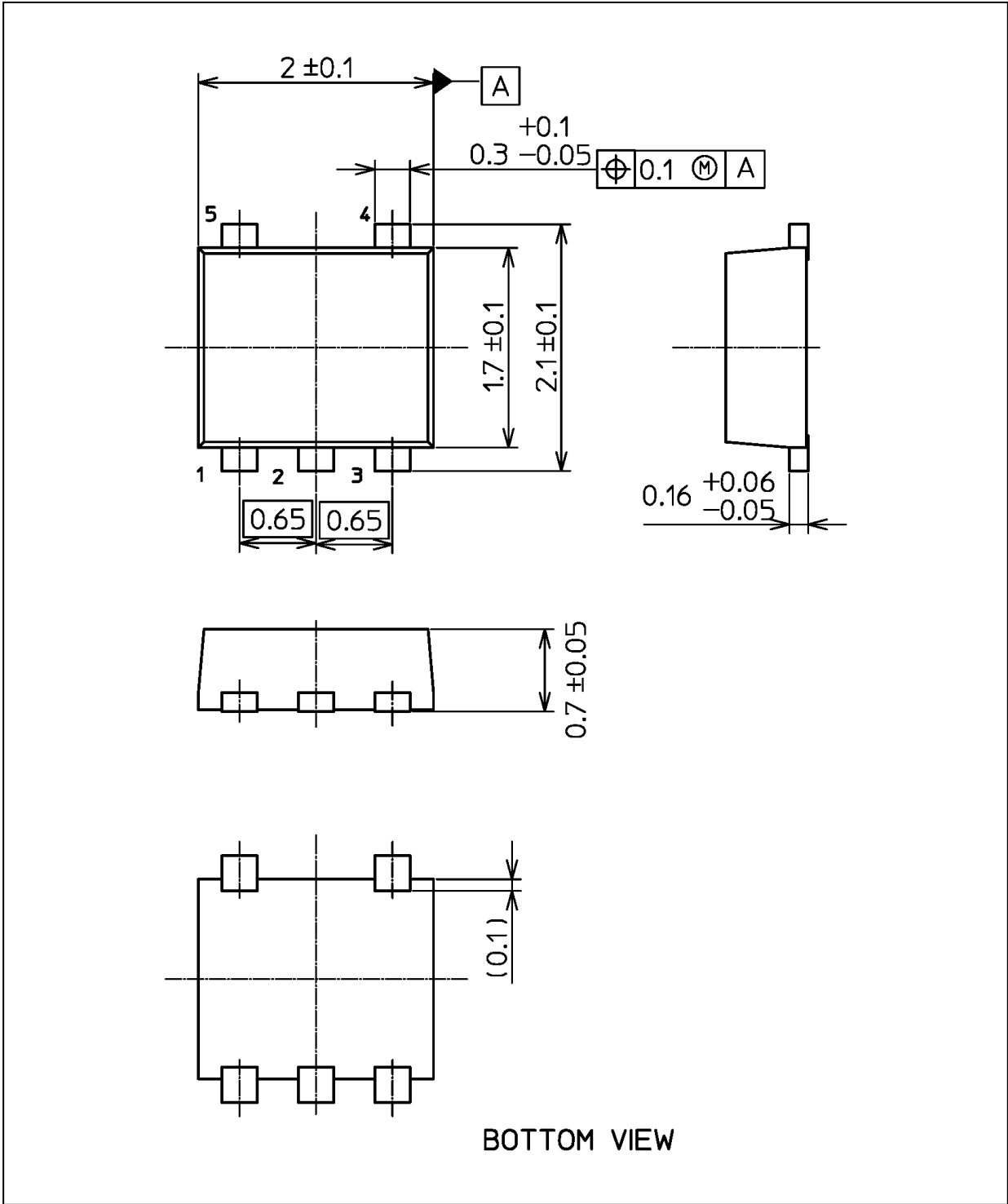

Weight: 7.0 mg (typ.)

Package Name(s)
Nickname: UFV

RESTRICTIONS ON PRODUCT USE

Toshiba Corporation and its subsidiaries and affiliates are collectively referred to as "TOSHIBA".

Hardware, software and systems described in this document are collectively referred to as "Product".

- TOSHIBA reserves the right to make changes to the information in this document and related Product without notice.
- This document and any information herein may not be reproduced without prior written permission from TOSHIBA. Even with TOSHIBA's written permission, reproduction is permissible only if reproduction is without alteration/omission.
- Though TOSHIBA works continually to improve Product's quality and reliability, Product can malfunction or fail. Customers are responsible for complying with safety standards and for providing adequate designs and safeguards for their hardware, software and systems which minimize risk and avoid situations in which a malfunction or failure of Product could cause loss of human life, bodily injury or damage to property, including data loss or corruption. Before customers use the Product, create designs including the Product, or incorporate the Product into their own applications, customers must also refer to and comply with (a) the latest versions of all relevant TOSHIBA information, including without limitation, this document, the specifications, the data sheets and application notes for Product and the precautions and conditions set forth in the "TOSHIBA Semiconductor Reliability Handbook" and (b) the instructions for the application with which the Product will be used with or for. Customers are solely responsible for all aspects of their own product design or applications, including but not limited to (a) determining the appropriateness of the use of this Product in such design or applications; (b) evaluating and determining the applicability of any information contained in this document, or in charts, diagrams, programs, algorithms, sample application circuits, or any other referenced documents; and (c) validating all operating parameters for such designs and applications. **TOSHIBA ASSUMES NO LIABILITY FOR CUSTOMERS' PRODUCT DESIGN OR APPLICATIONS.**
- **PRODUCT IS NEITHER INTENDED NOR WARRANTED FOR USE IN EQUIPMENTS OR SYSTEMS THAT REQUIRE EXTRAORDINARILY HIGH LEVELS OF QUALITY AND/OR RELIABILITY, AND/OR A MALFUNCTION OR FAILURE OF WHICH MAY CAUSE LOSS OF HUMAN LIFE, BODILY INJURY, SERIOUS PROPERTY DAMAGE AND/OR SERIOUS PUBLIC IMPACT ("UNINTENDED USE").** Except for specific applications as expressly stated in this document, Unintended Use includes, without limitation, equipment used in nuclear facilities, equipment used in the aerospace industry, medical equipment, equipment used for automobiles, trains, ships and other transportation, traffic signaling equipment, equipment used to control combustions or explosions, safety devices, elevators and escalators, devices related to electric power, and equipment used in finance-related fields. **IF YOU USE PRODUCT FOR UNINTENDED USE, TOSHIBA ASSUMES NO LIABILITY FOR PRODUCT.** For details, please contact your TOSHIBA sales representative.
- Do not disassemble, analyze, reverse-engineer, alter, modify, translate or copy Product, whether in whole or in part.
- Product shall not be used for or incorporated into any products or systems whose manufacture, use, or sale is prohibited under any applicable laws or regulations.
- The information contained herein is presented only as guidance for Product use. No responsibility is assumed by TOSHIBA for any infringement of patents or any other intellectual property rights of third parties that may result from the use of Product. No license to any intellectual property right is granted by this document, whether express or implied, by estoppel or otherwise.
- **ABSENT A WRITTEN SIGNED AGREEMENT, EXCEPT AS PROVIDED IN THE RELEVANT TERMS AND CONDITIONS OF SALE FOR PRODUCT, AND TO THE MAXIMUM EXTENT ALLOWABLE BY LAW, TOSHIBA (1) ASSUMES NO LIABILITY WHATSOEVER, INCLUDING WITHOUT LIMITATION, INDIRECT, CONSEQUENTIAL, SPECIAL, OR INCIDENTAL DAMAGES OR LOSS, INCLUDING WITHOUT LIMITATION, LOSS OF PROFITS, LOSS OF OPPORTUNITIES, BUSINESS INTERRUPTION AND LOSS OF DATA, AND (2) DISCLAIMS ANY AND ALL EXPRESS OR IMPLIED WARRANTIES AND CONDITIONS RELATED TO SALE, USE OF PRODUCT, OR INFORMATION, INCLUDING WARRANTIES OR CONDITIONS OF MERCHANTABILITY, FITNESS FOR A PARTICULAR PURPOSE, ACCURACY OF INFORMATION, OR NONINFRINGEMENT.**
- Do not use or otherwise make available Product or related software or technology for any military purposes, including without limitation, for the design, development, use, stockpiling or manufacturing of nuclear, chemical, or biological weapons or missile technology products (mass destruction weapons). Product and related software and technology may be controlled under the applicable export laws and regulations including, without limitation, the Japanese Foreign Exchange and Foreign Trade Law and the U.S. Export Administration Regulations. Export and re-export of Product or related software or technology are strictly prohibited except in compliance with all applicable export laws and regulations.
- Please contact your TOSHIBA sales representative for details as to environmental matters such as the RoHS compatibility of Product. Please use Product in compliance with all applicable laws and regulations that regulate the inclusion or use of controlled substances, including without limitation, the EU RoHS Directive. **TOSHIBA ASSUMES NO LIABILITY FOR DAMAGES OR LOSSES OCCURRING AS A RESULT OF NONCOMPLIANCE WITH APPLICABLE LAWS AND REGULATIONS.**

Mouser Electronics

Authorized Distributor

Click to View Pricing, Inventory, Delivery & Lifecycle Information:

[Toshiba:](#)

[TCS30DPU,LF](#)



Компания «ЭлектроПласт» предлагает заключение долгосрочных отношений при поставках импортных электронных компонентов на взаимовыгодных условиях!

Наши преимущества:

- Оперативные поставки широкого спектра электронных компонентов отечественного и импортного производства напрямую от производителей и с крупнейших мировых складов;
- Поставка более 17-ти миллионов наименований электронных компонентов;
- Поставка сложных, дефицитных, либо снятых с производства позиций;
- Оперативные сроки поставки под заказ (от 5 рабочих дней);
- Экспресс доставка в любую точку России;
- Техническая поддержка проекта, помощь в подборе аналогов, поставка прототипов;
- Система менеджмента качества сертифицирована по Международному стандарту ISO 9001;
- Лицензия ФСБ на осуществление работ с использованием сведений, составляющих государственную тайну;
- Поставка специализированных компонентов (Xilinx, Altera, Analog Devices, Intersil, Interpoint, Microsemi, Aeroflex, Peregrine, Syfer, Eurofarad, Texas Instrument, Miteq, Cobham, E2V, MA-COM, Hittite, Mini-Circuits, General Dynamics и др.);

Помимо этого, одним из направлений компании «ЭлектроПласт» является направление «Источники питания». Мы предлагаем Вам помощь Конструкторского отдела:

- Подбор оптимального решения, техническое обоснование при выборе компонента;
- Подбор аналогов;
- Консультации по применению компонента;
- Поставка образцов и прототипов;
- Техническая поддержка проекта;
- Защита от снятия компонента с производства.



Как с нами связаться

Телефон: 8 (812) 309 58 32 (многоканальный)

Факс: 8 (812) 320-02-42

Электронная почта: org@eplast1.ru

Адрес: 198099, г. Санкт-Петербург, ул. Калинина, дом 2, корпус 4, литера А.