

**Silicon PIN Diode**

- High voltage current controlled RF resistor for RF attenuator and switches
- Frequency range above 1 MHz up to 6 GHz
- Very low capacitance at zero volt reverse bias at frequencies above 1 GHz (typ. 0.17 pF)
- Low forward resistance (typ. 2.1  $\Omega$  @ 10 mA)
- Very low signal distortion
- Pb-free (RoHS compliant) package
- Qualified according AEC Q101<sup>1)</sup>



**BAR64-02EL**  
**BAR64-02V**  
**BAR64-03W**

**BAR64-04**  
**BAR64-04W**

**BAR64-05**  
**BAR64-05W**

**BAR64-06**  
**BAR64-06W**

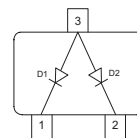
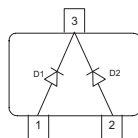
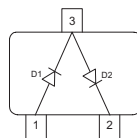

| Type        | Package   | Configuration    | $L_S$ (nH) | Marking |
|-------------|-----------|------------------|------------|---------|
| BAR64-02EL* | TSLP-2-19 | single, leadless | 0.4        | OE      |
| BAR64-02V   | SC79      | single           | 0.6        | O       |
| BAR64-03W   | SOD323    | single           | 1.8        | blue 2  |
| BAR64-04    | SOT23     | series           | 1.8        | PPs     |
| BAR64-04W   | SOT323    | series           | 1.4        | PPs     |
| BAR64-05    | SOT23     | common cathode   | 1.8        | PRs     |
| BAR64-05W   | SOT323    | common cathode   | 1.4        | PRs     |
| BAR64-06    | SOT23     | common anode     | 1.8        | PSs     |
| BAR64-06W   | SOT323    | common anode     | 1.4        | PSs     |

<sup>1)</sup>BAR64-02EL is not qualified according AEC Q101

**Maximum Ratings** at  $T_A = 25^\circ\text{C}$ , unless otherwise specified

| Parameter  | Symbol           | Value                           | Unit |
|--|------------------|---------------------------------|------|
| Diode reverse voltage  | $V_R$            | 150                             | V    |
| Forward current  | $I_F$            | 100                             | mA   |
| Total power dissipation<br>BAR64-02EL, $T_S \leq 135^\circ\text{C}$<br>BAR64-02V, $T_S \leq 125^\circ\text{C}$<br>BAR64-03W, $T_S \leq 25^\circ\text{C}$<br>BAR64-04, -05, -06, $T_S \leq 65^\circ\text{C}$<br>BAR64-04W, -05W, -06W, $T_S \leq 115^\circ\text{C}$ | $P_{\text{tot}}$ | 250<br>250<br>250<br>250<br>250 | mW   |
| Junction temperature   | $T_j$            | 150                             | °C   |
| Operating temperature range  | $T_{\text{op}}$  | -55 ... 125                     |      |
| Storage temperature  | $T_{\text{stg}}$ | -55 ... 150                     |      |

**Thermal Resistance**

| Parameter  | Symbol            | Value   | Unit |
|--|-------------------|---|------|
| Junction - soldering point <sup>1)</sup><br>BAR64-02EL<br>BAR64-02V, -04W, -05W, -06W<br>BAR64-03W<br>BAR64-04, -05, -06 | $R_{\text{thJS}}$ | $\leq 60$<br>$\leq 140$<br>$\leq 370$<br>$\leq 340$ | K/W  |

<sup>1)</sup>For calculation of  $R_{\text{thJA}}$  please refer to Application Note AN077 (Thermal Resistance Calculation)

**Electrical Characteristics** at  $T_A = 25^\circ\text{C}$ , unless otherwise specified

| Parameter  | Symbol            | Values |      |      | Unit |
|--|-------------------|--------|------|------|------|
|  |                   | min.   | typ. | max. |      |
| Breakdown voltage<br>$I_{(\text{BR})} = 5 \mu\text{A}$ | $V_{(\text{BR})}$ | 150    | -    | -    | V    |
| Forward voltage<br>$I_F = 50 \text{ mA}$               | $V_F$             | -      | -    | 1.1  |      |

**DC Characteristics**

**Electrical Characteristics at  $T_A = 25^\circ\text{C}$ , unless otherwise specified**

| Parameter   | Symbol      | Values           |                             |                     | Unit          |
|---|-------------|------------------|-----------------------------|---------------------|---------------|
|   |             | min.             | typ.                        | max.                |               |
| <b>AC Characteristics</b>   |             |                  |                             |                     |               |
| Diode capacitance<br>$V_R = 20\text{ V}, f = 1\text{ MHz}$<br>$V_R = 0\text{ V}, f = 100\text{ MHz}$<br>$V_R = 0\text{ V}, f = 1\dots 1.8\text{ GHz}, \text{BAR64-02EL}$<br>$V_R = 0\text{ V}, f = 1\dots 1.8\text{ GHz}, \text{all other}$ | $C_T$       | -<br>-<br>-<br>- | 0.23<br>0.3<br>0.13<br>0.17 | 0.35<br>-<br>-<br>- | pF            |
| Reverse parallel resistance<br>$V_R = 0\text{ V}, f = 100\text{ MHz}$<br>$V_R = 0\text{ V}, f = 1\text{ GHz}$<br>$V_R = 0\text{ V}, f = 1.8\text{ GHz}$   | $R_P$       | -<br>-<br>-      | 10<br>4<br>3                | -<br>-<br>-         | k $\Omega$    |
| Forward resistance<br>$I_F = 1\text{ mA}, f = 100\text{ MHz}$<br>$I_F = 10\text{ mA}, f = 100\text{ MHz}$<br>$I_F = 100\text{ mA}, f = 100\text{ MHz}$  | $r_f$       | -<br>-<br>-      | 12.5<br>2.1<br>0.85         | 20<br>2.8<br>1.35   | $\Omega$      |
| Charge carrier life time<br>$I_F = 10\text{ mA}, I_R = 6\text{ mA}, \text{measured at } I_R = 3\text{ mA},$<br>$R_L = 100\ \Omega$  | $\tau_{rr}$ | -                | 1550                        | -                   | ns            |
| I-region width  | $W_I$       | -                | 50                          | -                   | $\mu\text{m}$ |
| Insertion loss <sup>1)</sup><br>$I_F = 3\text{ mA}, f = 1.8\text{ GHz}$<br>$I_F = 5\text{ mA}, f = 1.8\text{ GHz}$<br>$I_F = 10\text{ mA}, f = 1.8\text{ GHz}$  | $I_L$       | -<br>-<br>-      | 0.32<br>0.23<br>0.16        | -<br>-<br>-         | dB            |
| Isolation <sup>1)</sup><br>$V_R = 0\text{ V}, f = 0.9\text{ GHz}$<br>$V_R = 0\text{ V}, f = 1.8\text{ GHz}$<br>$V_R = 0\text{ V}, f = 2.45\text{ GHz}$<br>$V_R = 0\text{ V}, f = 5.6\text{ GHz}$  | $I_{SO}$    | -<br>-<br>-<br>- | 22<br>17<br>14.5<br>8.5     | -<br>-<br>-<br>-    |               |

<sup>1</sup>BAR64-02EL in series configuration,  $Z = 50\ \Omega$

**Diode capacitance  $C_T = f(V_R)$**

$f =$  Parameter



**Reverse parallel resistance  $R_p = f(V_R)$**

$f =$  Parameter



**Forward resistance  $r_f = f(I_F)$**

$f = 100\text{MHz}$



**Forward current  $I_F = f(V_F)$**

$T_A =$  Parameter



**Intermodulation intercept point**

$IP_3 = f(I_F); f = \text{Parameter}$



**Forward current  $I_F = f(T_S)$**

BAR64-02EL



**Forward current  $I_F = f(T_S)$**

BAR64-02V



**Forward current  $I_F = f(T_S)$**

BAR64-04, BAR64-05, BAR64-06



**Forward current  $I_F = f(T_S)$**

BAR64-04W, BAR64-05W, BAR64-06W



**Permissible Puls Load  $R_{thJS} = f(t_p)$**

BAR64-02EL



**Permissible Pulse Load**

$I_{Fmax} / I_{FDC} = f(t_p)$

BAR64-02EL



**Permissible Puls Load  $R_{thJS} = f(t_p)$**

BAR64-02V



**Permissible Pulse Load**

$I_{Fmax} / I_{FDC} = f(t_p)$

BAR64-02V

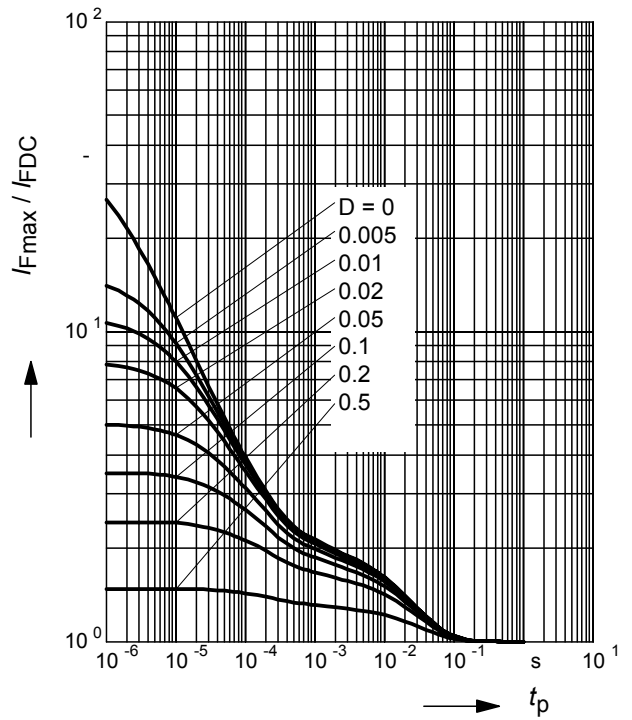

**Permissible Puls Load  $R_{thJS} = f(t_p)$**

BAR64-04, BAR64-05, BAR64-06



**Permissible Pulse Load**

$I_{Fmax} / I_{FDC} = f(t_p)$

BAR64-04, BAR64-05, BAR64-06



**Permissible Puls Load  $R_{thJS} = f(t_p)$**   
 BAR64-04W, BAR64-05W, BAR64-06W



**Permissible Pulse Load**  
 $I_{Fmax}/I_{FDC} = f(t_p)$   
 BAR64-04W, BAR64-05W, BAR64-06W



**Insertion loss  $I_L = -|S_{21}|^2 = f(f)$**   
 $I_F$  = Parameter  
 BAR64-02EL in series configuration,  $Z = 50\Omega$



**Isolation  $I_{SO} = -|S_{21}|^2 = f(f)$**   
 $V_R$  = Parameter  
 BAR64-02EL in series configuration,  $Z = 50\Omega$

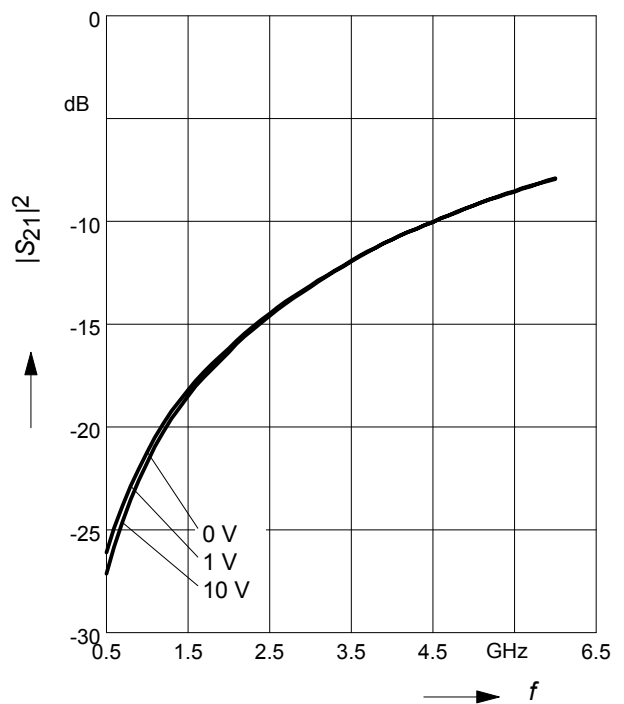



### Package Outline



### Foot Print



### Marking Layout (Example)



### Standard Packing

- Reel  $\varnothing$ 180 mm = 3.000 Pieces/Reel
- Reel  $\varnothing$ 180 mm = 8.000 Pieces/Reel (2 mm Pitch)
- Reel  $\varnothing$ 330 mm = 10.000 Pieces/Reel



Date Code marking for discrete packages with one digit (SCD80, SC79, SC75<sup>1)</sup>) CES-Code

| Month | 2003 | 2004 | 2005 | 2006 | 2007 | 2008 | 2009 | 2010 | 2011 | 2012 | 2013 | 2014 |
|-------|------|------|------|------|------|------|------|------|------|------|------|------|
| 01    | a    | p    | A    | P    | a    | p    | A    | P    | a    | p    | A    | P    |
| 02    | b    | q    | B    | Q    | b    | q    | B    | Q    | b    | q    | B    | Q    |
| 03    | c    | r    | C    | R    | c    | r    | C    | R    | c    | r    | C    | R    |
| 04    | d    | s    | D    | S    | d    | s    | D    | S    | d    | s    | D    | S    |
| 05    | e    | t    | E    | T    | e    | t    | E    | T    | e    | t    | E    | T    |
| 06    | f    | u    | F    | U    | f    | u    | F    | U    | f    | u    | F    | U    |
| 07    | g    | v    | G    | V    | g    | v    | G    | V    | g    | v    | G    | V    |
| 08    | h    | x    | H    | X    | h    | x    | H    | X    | h    | x    | H    | X    |
| 09    | j    | y    | J    | Y    | j    | y    | J    | Y    | j    | y    | J    | Y    |
| 10    | k    | z    | K    | Z    | k    | z    | K    | Z    | k    | z    | K    | Z    |
| 11    | l    | 2    | L    | 4    | l    | 2    | L    | 4    | l    | 2    | L    | 4    |
| 12    | n    | 3    | N    | 5    | n    | 3    | N    | 5    | n    | 3    | N    | 5    |

1) New Marking Layout for SC75, implemented at October 2005.

Package Outline



Foot Print

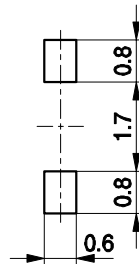

Marking Layout (Example)



Standard Packing

Reel ø180 mm = 3.000 Pieces/Reel  
 Reel ø330 mm = 10.000 Pieces/Reel



Package Outline



1) Lead width can be 0.6 max. in dambar area

Foot Print



Marking Layout (Example)



Standard Packing

Reel  $\varnothing$ 180 mm = 3.000 Pieces/Reel  
 Reel  $\varnothing$ 330 mm = 10.000 Pieces/Reel



Package Outline



Foot Print



Marking Layout (Example)



Standard Packing

Reel ø180 mm = 3.000 Pieces/Reel  
 Reel ø330 mm = 10.000 Pieces/Reel



Package Outline

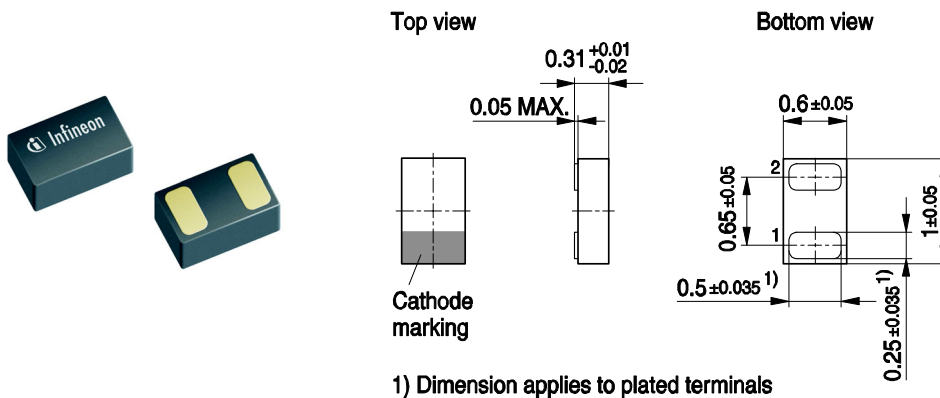

TSLP-2-19, -20-PO V01

Foot Print

For board assembly information please refer to Infineon website „Packages“

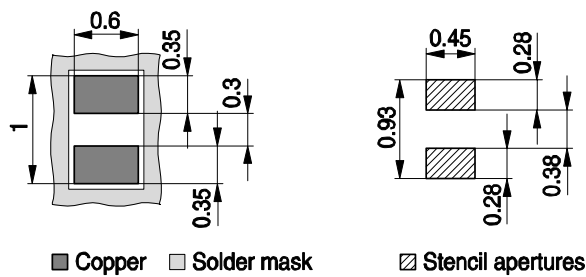

TSLP-2-19, -20-FP V01

Marking layout (Example)



Standard Packing

Reel Ø 180 mm: 15.000 Pieces / Reel  
 Reel Ø 330 mm: 6.000 Pieces / Reel  
 Reel Ø 330 mm: 50.000 Pieces / Reel

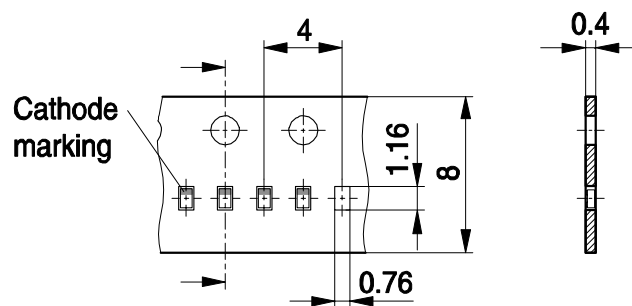

TSLP-2-19, -20-TP V02

**Edition 2009-11-16**

**Published by  
Infineon Technologies AG  
81726 Munich, Germany**

**© 2009 Infineon Technologies AG  
All Rights Reserved.**

### **Legal Disclaimer**

The information given in this document shall in no event be regarded as a guarantee of conditions or characteristics. With respect to any examples or hints given herein, any typical values stated herein and/or any information regarding the application of the device, Infineon Technologies hereby disclaims any and all warranties and liabilities of any kind, including without limitation, warranties of non-infringement of intellectual property rights of any third party.

### **Information**

For further information on technology, delivery terms and conditions and prices, please contact the nearest Infineon Technologies Office ([www.infineon.com](http://www.infineon.com)).

### **Warnings**

Due to technical requirements, components may contain dangerous substances. For information on the types in question, please contact the nearest Infineon Technologies Office.

Infineon Technologies components may be used in life-support devices or systems only with the express written approval of Infineon Technologies, if a failure of such components can reasonably be expected to cause the failure of that life-support device or system or to affect the safety or effectiveness of that device or system. Life support devices or systems are intended to be implanted in the human body or to support and/or maintain and sustain and/or protect human life. If they fail, it is reasonable to assume that the health of the user or other persons may be endangered.



Компания «ЭлектроПласт» предлагает заключение долгосрочных отношений при поставках импортных электронных компонентов на взаимовыгодных условиях!

Наши преимущества:

- Оперативные поставки широкого спектра электронных компонентов отечественного и импортного производства напрямую от производителей и с крупнейших мировых складов;
- Поставка более 17-ти миллионов наименований электронных компонентов;
- Поставка сложных, дефицитных, либо снятых с производства позиций;
- Оперативные сроки поставки под заказ (от 5 рабочих дней);
- Экспресс доставка в любую точку России;
- Техническая поддержка проекта, помощь в подборе аналогов, поставка прототипов;
- Система менеджмента качества сертифицирована по Международному стандарту ISO 9001;
- Лицензия ФСБ на осуществление работ с использованием сведений, составляющих государственную тайну;
- Поставка специализированных компонентов (Xilinx, Altera, Analog Devices, Intersil, Interpoint, Microsemi, Aeroflex, Peregrine, Syfer, Eurofarad, Texas Instrument, Miteq, Cobham, E2V, MA-COM, Hittite, Mini-Circuits, General Dynamics и др.);

Помимо этого, одним из направлений компании «ЭлектроПласт» является направление «Источники питания». Мы предлагаем Вам помощь Конструкторского отдела:

- Подбор оптимального решения, техническое обоснование при выборе компонента;
- Подбор аналогов;
- Консультации по применению компонента;
- Поставка образцов и прототипов;
- Техническая поддержка проекта;
- Защита от снятия компонента с производства.



#### Как с нами связаться

**Телефон:** 8 (812) 309 58 32 (многоканальный)

**Факс:** 8 (812) 320-02-42

**Электронная почта:** [org@eplast1.ru](mailto:org@eplast1.ru)

**Адрес:** 198099, г. Санкт-Петербург, ул. Калинина, дом 2, корпус 4, литера А.