



Plugs & Jacks

Content Page

Plugs:

1/4" Phone Plug - PX Series	40
1/4" Phone Plug - silentPLUG	41
1/4" Phone Plug - timbrePLUG	42
1/4" Phone Plug - crystalCON	43
1/4" Phone Plugs - C Series	43
MIL / B-Gauge Type Phone Plugs	43
0.173" Bantam Type Miniature Plugs	44
3.5 mm Right-Angle Stereo Plug	44
Technical Data	45
Accessories	45
Ordering Information	46

Jacks:

Locking 1/4" Cable Jacks	47
Locking 1/4" Chassis Jacks	47
1/4" Vertical Jacks	48
M Jacks	49
Slim Jacks	50
Stacking Jacks	51
Technical Data	52
Ordering Information	53
Accessories	54

Phono (RCA):

Profi - RCA Serie	55
Phono Socket	55
Technical Data	56
Ordering Information	56
Accessories	56





Introduction

The Neutrik® plug and jack program offers a wide range of professional phone connectors including 1/4", 3.5 mm, MIL/B-gauge style and TT or bantam style plugs. The jack range offers an exceptional "slim" 1/4" PCB jack that is almost 20% smaller than most other designs. The heavy duty M line combines a wide range of options such as three different nose forms and four styles of contacts including 3 PCB and one solder tab. It also includes a 1/4" chassis and cable jack line with the secure locking feature, well known from the XLR range. All jacks are manufactured from strong high-grade thermoplastics and are available in all common versions which make them suitable for audio and industrial applications.

The plug line features:

- Mono (TS) and Stereo (TRS) plugs
- Straight and right-angle versions
- Rugged diecast shell in nickel or black chromium
- Nickel or gold plated contacts
- Chuck type strain relief
- Precision machined plugfinger without rivets
- Coloured boots and rings for coding
- Silent Plug for instrument (guitar) applications

All plugs and jacks are specified to IEC 60603-11 and EIA RS-453 or the respective MIL standard.

Neutrik® also offers a special jack version which is a combined 3 pole XLR receptacle and a 1/4" phone jack for balanced mic or line inputs in one XLR shell. This "one for two" panel mount offers substantial cost, labour and material savings. For more information on the Combo products see page 29 and 30 or visit our website at www.neutrik.com.

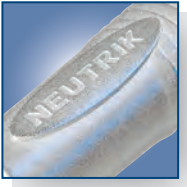

Neutrik brand

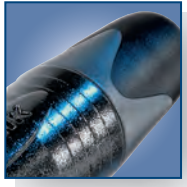

Anti-kink bushing



Chuck type strain relief

1/4" Phone Plug - PX and PRX Series



NP2X



NP3X-B



NP3X + PRX-5



NP3RX-B

- Slim 1/4" plug with million fold proven chuck type strain relief
- Precision machined one piece contacts - no rivets
- Sleek attractive design for best handling convenience
- 14.5 mm only in diameter (right angle 15.4 mm) - serves highest packing density of 15.88 mm jack pitch
- Nickel or gold plugfinger in mono (TS) and stereo (TRS)
- Screwless assembly (PRX series as well)
- L-D version available which accommodates cables O.D. up to 8 mm

15.88 mm jack pitch:



NP3X

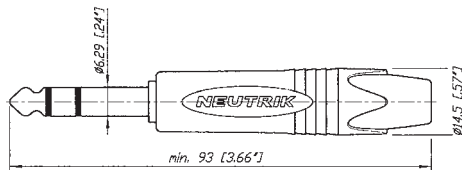

NP2RX

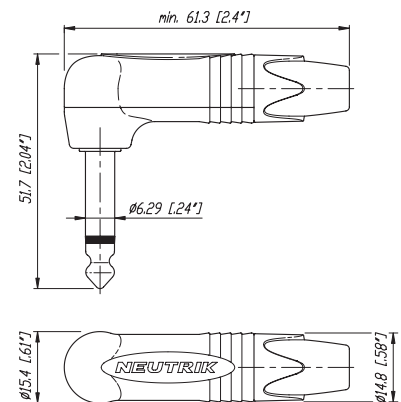



Moving magnet



Right angle plug

Attention!

For use with instrument (guitar) applications only. Damage may occur if connected to amplifier.

1/4" Phone Plug - silentPLUG



NP2X-AU-SILENT



NP2RX-AU-SILENT

Design Criteria

The silentPLUG automatically mutes (shorts) an instrument (guitar) cable to avoid pops and squeals when changing the instrument (guitar) under load.

The integrated silent switch (pat. pending) is based on REED-technology and guarantees a lifetime beyond 10000 mating cycles.

The PX silentPLUG features a rugged metal shell enhanced with a rubber cushion overlay for improved shock protection.

- Avoid pops and squeals
- Hermetically sealed switching contacts
- Lifetime beyond 10'000 mating cycles
- Slim right-angle plug with industry proven and reliable chuck type cable strain relief
- Sleek attractive design for convenient handling and connections
- Rubber overlay on straight housing for best shock-protection and reliability
- L-D version available which accommodates cables O.D. up to 8 mm

Detail Silent Switch:

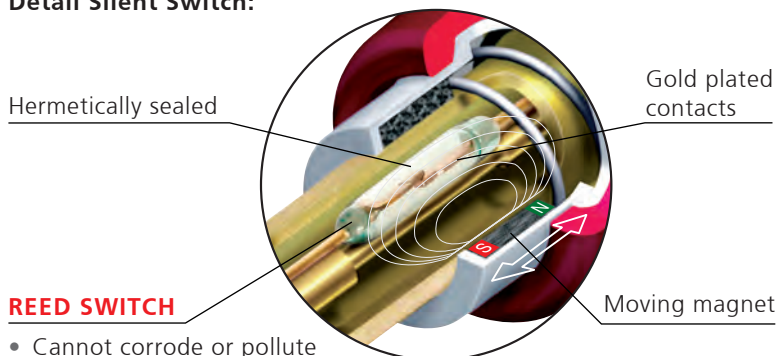

- Cannot corrode or pollute
- No wear, constant contact resistance
- Decoupled from switching mechanism

NP2X-AU-SILENT

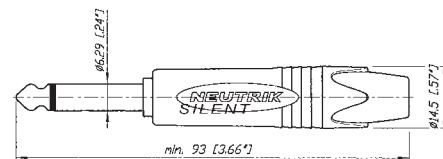



Rotary knob to change the timbre

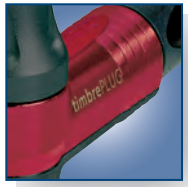

Right angle plug

1/4" Guitar Plug - timbrePLUG

NEW



NP2RX-TIMBRE

Design Criteria

The characteristic sound of a guitar is not only influenced by the guitar (strings, pickups, body) alone but also by the attached instrument cable and the following guitar amp. The timbrePLUG provides the possibility to change the timbre of your guitar sound from neutral, clear sound to warm characteristics.

(not applicable when used with active guitar pickups)

- Standard timbre of your cable plus 3 additional sound characteristics
- Slim right-angle plug with industry proven and reliable chuck type cable strain relief
- Sleek attractive design for convenient handling
- Gold plug finger, precision machined one piece contacts

timbrePLUG - charakteristic

- neutral position / basic sound characteristic
- position 1 / sound characteristic 1
- position 2 / sound characteristic 2
- position 3 / sound characteristic 3

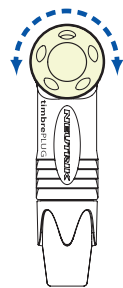
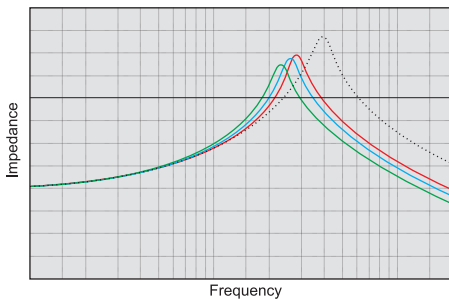

NP2RX-TIMBRE

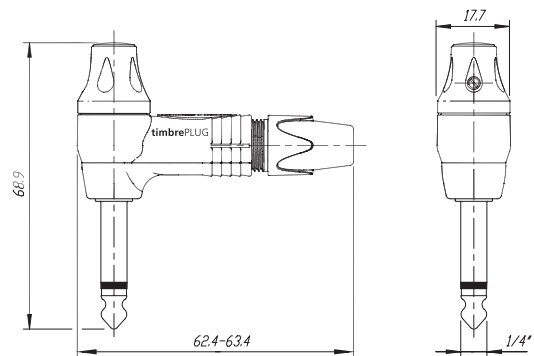



Crystal stones



The standard of professional phone plugs



B-Gauge type

crystalCON



NP2X-B-CRYSTAL

C Series



NP2C + BSP-3

MIL/B-Gauge Type Plugs



NP3TB-R

NP3CM-B

- Mono 1/4" phone plug embellished with CRYSTALLIZED™ – Swarovski Elements
- Fancy, noble, valuable, attractive package - an eye-catcher

- Available in mono (TS) or stereo (TRS)
- Meets EIA / IEC standards
- Unique plug finger design without rivets
- Sturdy diecast metal shell
- Excellent Neutrik® chuck type strain relief

- 1/4" "B-Gauge" and "MIL" Type Plugs
- All metal design, chuck type strain relief, no rivets
- Meet all prevailing standards
- Available as plug fingers only for overmolding

NP2X-B-CRYSTAL

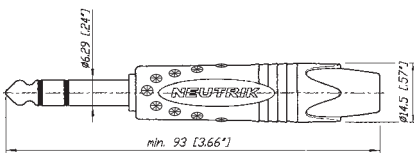

NP3C

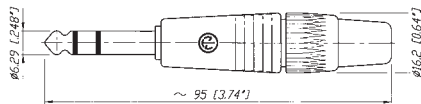

NP3TB-B

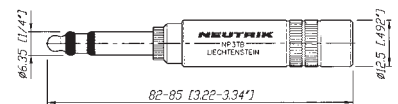

NP3CM-B

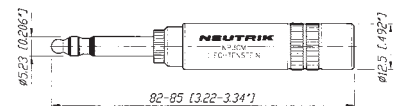



Bantam plug



Dual bantam plug



Gold plated contacts



Easy connector assembly

0.173" Bantam Type Miniature Plugs



NP3TT-1-B



NP3TT-2

- Very robust ergonomic design
- Gold contact version in combination with the NJ3TTA jack eliminates contact problems due to corrosion or dirt
- The single plug NP3TT-P and the dual bantam plug NP3TT-2 are made for assembling with a standard HEX crimping tool as used with coax cables
- Solder termination for T + R, crimp termination for sleeve contact

NP3TT-1

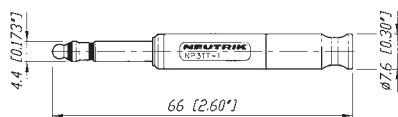

NP3TT-P



3.5 mm Right-Angle Stereo Plug



NTP3RC

- The only available 3.5 mm plug with chuck type strain relief
- All metal housing - reliable and robust
- Easy to assemble, simple to use
- Slim design - space saving
- Excellent cable protection
- All Nickel or black housing, available with gold plated contacts

NTP3RC

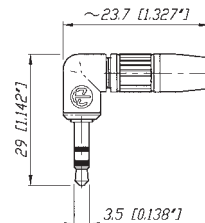

Specifications

	1/4" Phone Plugs SILENT & CRYSTAL & timbrePLUG	MIL / B-Gauge Type	0.173" Bantam Type	3.5 mm Stereo Plugs
--	--	--------------------	--------------------	---------------------

Electrical

Rated current:	depends on mating connector	●	●	●	●
Contact resistance:	depends on mating connector	●	●	●	●
Insulation resistance: - initial:	> 2 GΩ	●	●	●	●
- after damp heat test:	≥ 1 GΩ	●	●	●	●
Dielectric strength	1 kV dc	●	●	●	●

Mechanical

Lifetime > 1'000 mating cycles		●	●	●	●
Wiring:	solder terminals	●	●	●	●
Wire size	mm ²	1	1 (NP3CM: 0.5)	0.25	0.22
	AWG	18	18 (NP3CM: 20)	24	24
Cable O.D.:	mm	4 - 7	4 - 7	4.8 max	2 - 4.5

Materials

Shell:	Zinc diecast (ZnAl4Cu1) Ni or black Cr plated	Brass (CuZn39Pb3) black or red coated	Brass (CuZn39Pb3) 2 μm Ni (Su) plated PA 6 30 % GR	Zinc diecast (ZnAl4Cu1) Ni or black Cr plated PA 6.6 15% GR
Insulation: Polyamide (PA 6.6 30 % GR)	●	●	●	●
Contacts: Brass (CuZn39Pb3) 2 μm Ni (Su) or Au plated	●	● or Brass	● (Tip: CuSn6) 2 μm TRIBOR® (NiP-AuCo)	●
Chuck:	POM	POM	-	POM
Bushing:	POM + PU	-	-	CuZn39Pb3 + PU (Ni or black Chrome)
Rubber shell-overlay:	EPDM	-	-	-

Environmental

Temperature range: -20 °C to +65 °C	●	●	●	●
Solderability: Complies with IEC 68-2-20	●	●	●	●

Accessories



BSP-*



BPX-*



PXR-*



BSTT-*



BSTP-*



PCR-*

BSP-*	Colored bushing for NP*C Series	BSTP-*	Colored sleeves for NP3TT-P Series
BPX-*	Colored bushing for NP*X Series	PXR-*	Colored marking rings for NP*X Series
BPX-L	Large bushing for NP*X Series up to 8.0 mm cable O.D.	PCR-*	Colored marking rings for NP*C Series
BSTT-*	Colored sleeves for NP3TT Series		

*: 0 - Black, 1 - Brown, 2 - Red, 3 - Orange, 4 - Yellow, 5 - Green, 6 - Blue, 7 - Violet, 8 - Grey, 9 - White; Must be ordered in multiples of 100.

Assembly tool

HX-TT-1	Assembly and crimp tool for NP3TT-1/AU
HX-R-BNC	HEX crimp tool for NP3TT-P*
DIE-R-BNC-PJ	HEX crimp die for NP3TT-P* (5.4 mm)
HTXP	Hand tool to tighten the PX and XX-bushing
HTPXS	Hand tool to hold shell of PX Plug

Ordering Information

Part Number	Shell	Contacts	Standards Compatibility	Remarks
-------------	-------	----------	----------------------------	---------

1/4" Professional Phone Plugs - PX and PRX Series

NP2X	NP2RX	Nickel	Nickel	IEC 60603-11 / EIA RS-453	Mono plug, black bushing
NP2X-BAG	NP2RX-BAG	Black Cr	Nickel	●	Mono plug, black bushing
NP2X-B	NP2RX-B	Black Cr	Gold	●	Mono plug, black bushing
NP3X	NP3RX	Nickel	Nickel	●	Stereo plug, black bushing
NP3X-BAG	NP3RX-BAG	Black Cr	Nickel	●	Stereo plug, black bushing
NP3X-B	NP3RX-B	Black Cr	Gold	●	Stereo plug, black bushing
*-D					Bulk packed to be ordered in multiples of 100

silentPLUG - Guitar Plug

NP2X-AU-SILENT	Rubber overlay	Gold	IEC 60603-11/EIA RS-453		Mono plug, silent switch
NP2RX-AU-SILENT	red coated	Gold	IEC 60603-11/EIA RS-453		Right angle mono plug, silent switch

timbrePLUG - special Guitar Plug

NP2RX-TIMBRE	red coated	Gold	IEC 60603-11/EIA RS-453		Right angle mono plug, timbre switch
--------------	------------	------	-------------------------	--	--------------------------------------

crystalCON - 1/4" Professional Phone Plug

NP2X-B-CRYSTAL	Black Cr	Gold	IEC 60603-11/EIA RS-453		Mono plug, black bushing, equipped with CRYSTALLIZED™ – Swarovski Elements
----------------	----------	------	-------------------------	--	---

1/4" Professional Phone Plugs - PC Series

NP2C	Nickel	Nickel	IEC 60603-11/EIA RS-453		Mono plug, black bushing
NP2C-BAG	Black Cr	Nickel	●		Mono plug, black bushing
NP2C/B	Black Cr	Gold	●		Mono plug, black bushing and gold contacts
NP3C	Nickel	Nickel	●		Stereo plug, black bushing
NP3C-BAG	Black Cr	Nickel	●		Stereo plug, black bushing
NP3C/B	Black Cr	Gold	●		Stereo plug, black bushing and gold contacts
NP2C-BAG-T-AU	Black Cr	Nickel + T: Gold	●		Mono plug, black bushing with gold tip
NP2C-T10AA	Nickel	Nickel	●		Mono plug, red bushing, with built-in 1:10 transformer to convert microphone levels to guitar inputs
NP2RCS	Nickel + black plastic	Nickel	●		Mono right-angle plug, black bushing
NP3RCS	Nickel + black plastic	Nickel	●		Stereo right-angle plug, black bushing
NP*C-D					Bulk packed to be ordered in multiples of 100

MIL/B-gauge Type Phone Plugs

NP3TB-B	Black	Nickel	B-GAUGE BP0316		1/4" B-Gauge plug
NP3TB-R	Red	Nickel	●		1/4" B-Gauge plug
NP3TM-B	Black	Nickel	MIL-P-642/2		1/4" MIL plug
NP3TM-R	Red	Nickel	●		1/4" MIL plug
NP2CM-B	Black	Brass	MIL-P-642/4		Mono 1/4" MIL plug
NP2CM-R	Red	Brass	●		Mono 1/4" MIL plug
NP3CM-B	Black	Brass	MIL-P642/5A		Stereo 5.23 mm (0.206") MIL plug
NP3CM-R	Red	Brass	●		Stereo 5.23 mm (0.206") MIL plug

0.173" Bantam Type Miniature Plugs

NP3TT-1-B	Nickel + black plastic	Nickel	MIL-P-642/13		4.4 mm (0.173") Bantam plug with solder contacts, black sleeve
NP3TT-1-R	Nickel + red plastic	Nickel	●		4.4 mm (0.173") Bantam plug with solder contacts, red sleeve
NP3TT-AU-B	Nickel + black plastic	Gold	●		4.4 mm (0.173") Bantam plug with solder contacts, black sleeve
NP3TT-AU-R	Nickel + red plastic	Gold	●		4.4 mm (0.173") Bantam plug with solder contacts, red sleeve
NP3TT-P-B	Black plastic	Nickel	●		4.4 mm (0.173") Bantam plug with solder contacts, black sleeve
NP3TT-P-R	Red plastic	Nickel	●		4.4 mm (0.173") Bantam plug with solder contacts, red sleeve
NP3TT-P-AU-B	Black plastic	Gold	●		4.4 mm (0.173") Bantam plug with solder contacts, black sleeve
NP3TT-P-AU-R	Red plastic	Gold	●		4.4 mm (0.173") Bantam plug with solder contacts, red sleeve
NP3TT-2	Black plastic	Nickel	●		4.4 mm (0.173") Twin Bantam plug with solder contacts, black sleeve

3.5 mm Right-Angle Stereo Plug

NTP3RC	Nickel	Nickel	IEC 60603-11		3.5 mm audio plug with chuck and bushing
NTP3RC-B	Black Cr	Gold	IEC 60603-11		3.5 mm audio plug with chuck and bushing



Locking Jacks

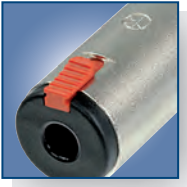

1/4" cable jack with locking



Release latch

Locking 1/4" Cable Jacks



NJ3FC6



NJ3FC6-BAG

- Securely locking cable jack
- Mates with all mono or stereo plugs specified to EIA RS-453
- Extremely robust and reliable
- Excellent Neutrik cable retention
- Coloured boots available in 10 colours
- For cable O.D. up to 8 mm

Locking 1/4" Chassis Jacks



NJ3FP6C



NJ3FP6C-BAG

- Mates with all mono or stereo plugs specified to EIA RS-453
- Dimensionally compatible with D Series (31 x 26 mm)
- Securely locking chassis jack
- Solder terminals
- Special version with black plastic shell
- Choice of grounding option (see on www.neutrik.com)

NJ3FC6

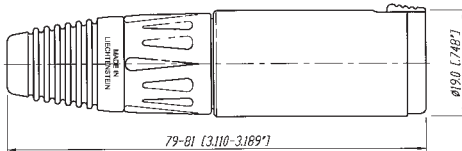

NJ3FP6C

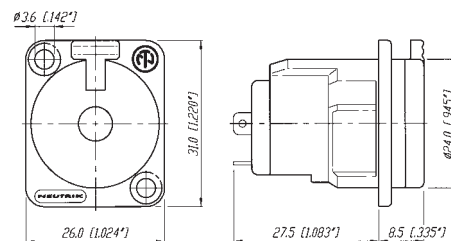



Snapping cap

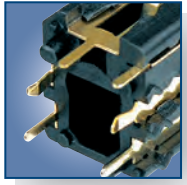

Solder tags

1/4" Vertical Jacks

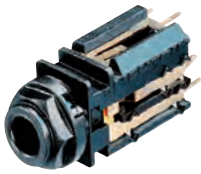

NJ*FD-V



NJ6TB-V

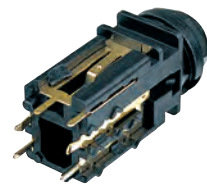

- Neutrik 1/4" Vertical PCB Jacks come in either standard 1/4" (FD) or mil gauge (TB) versions
- They feature a snap on/twist off cap which drastically reduces assembly times
- Retention force is provided by a special spring element independent of the contacts which results in optimal contact force with minimal contact wear
- Gold plated contact area for long durability and reliable, corrosion free operation

- High packing density compact design allows for more jacks in less space
- Available in Stereo switching and non-switching versions, and Mono non-switching version
- Over 10,000 insertion/withdrawal cycles

NJ*FD-V

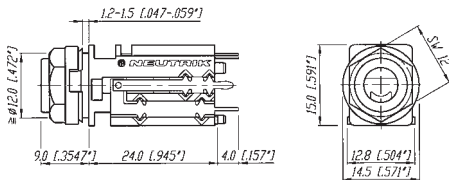

*: 2, 3, 5, 6



Half threaded nose



Chrome ferrule



Plastic nut

M Jacks



NMJ4HHD2

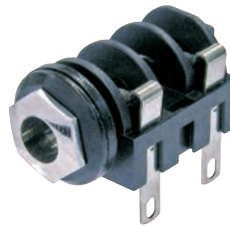

NMJ2HC-S



NMJ6HFD2

- Wide body and extremely durable contacts
- Available in all common versions:
 - mono
 - stereo
 - switched
 - unswitched
- Hardwire and PCB version
- Nose type in
 - half threaded
 - fully threaded
 - chrome ferrule
- Full threaded and chrome nose M Jacks are supplied with washer and fixing nut
- Mounting hardware for half threaded nose must be ordered separately
- Fascia appearance in plastic or chrome

NMJ6HHD2

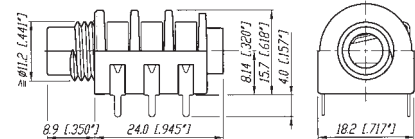

NMJ4HC-S

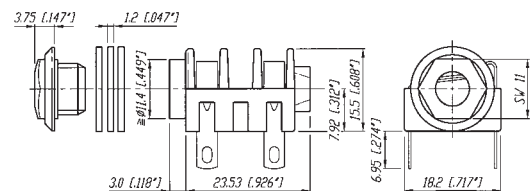

NRJ-NUT-B

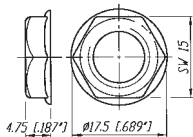

NRJ-WB (washer)

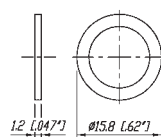

NMJ6HFD2

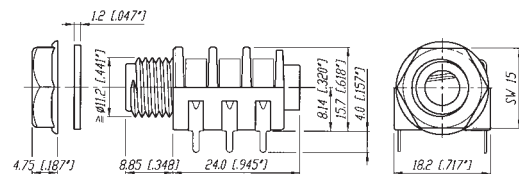

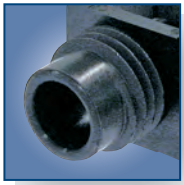

Half threaded nose

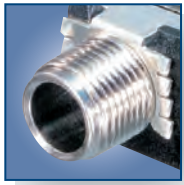

Chrome nose



Chassis ground contact



Gold plated contact

Slim Jacks

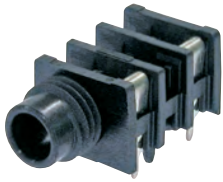

NRJ4HH-1

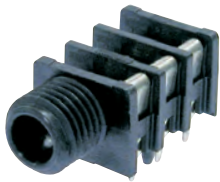

NRJ6HF-1



NRJ6HM-1



NRJ-NUT-B



NRJ-NUT-MK

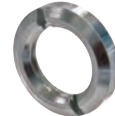

NRJ-NUT-MS



NRJ-NUT-MN
(Metal Nose only)

- High board packing densities
- Nose type in
 - half thread
 - fully threaded
 - metal
- *-1 versions meet the requirements of EMC rules through efficient chassis grounding system
- Retention spring ensures optimum grip on inserted plugs, avoiding the chance of lost connection
- All Slim line jacks have PCB horizontal mount pins
- Mounting nuts in different versions available - must be ordered separately

NRJ-NUT-B

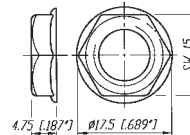

NRJ-NUT-MK

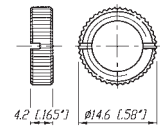

NRJ-NUT-MS

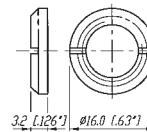

NRJ-NUT-MN

(Only compatible with metal nose).
Thread pitch is a 3/8" 32 UNEF 2A.

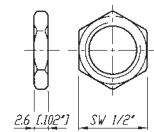

NRJ4HH-1

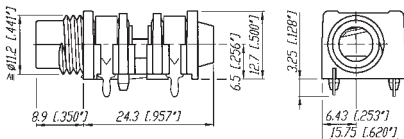

NRJ4HF-1

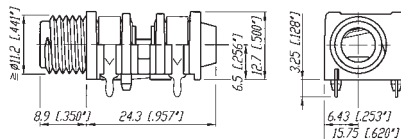

NRJ6HM-1

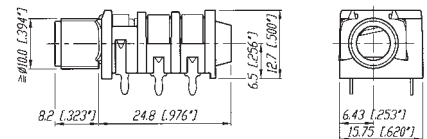



Plane nose



Quick fix nose



Quick fix nut



Fully threaded nose

Stacking Jacks



NSJ8HC

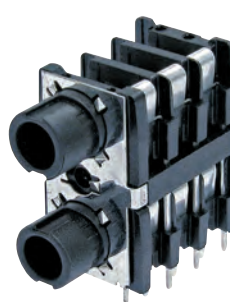

NSJ12HL



NSJ12HH-1



NSJ12HF-1

- Mono and stereo dual slim jack socket for PCB mounting with switch contacts
- Mounting method by either two quick fix or threaded nuts or one single center screw
- Highest board packing density as two jacks are in a single footprint, fit in 1 RU
- Version in fully and half threaded nose, full nose, quick-fit and plane

NSJ8HC

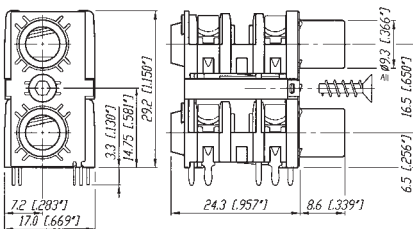

NSJ12HL

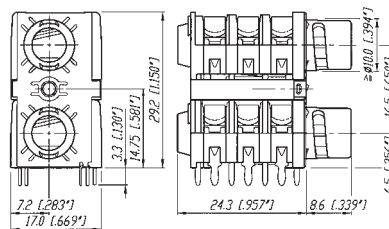

NSJ-NUT-B

(Quick fix nut)

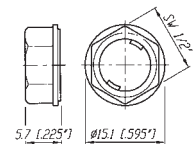

NSJ12HH-1

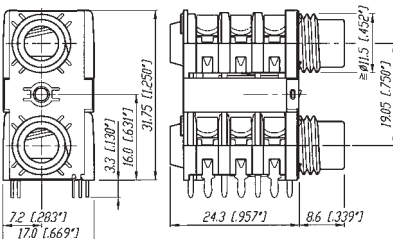

NSJ12HF-1

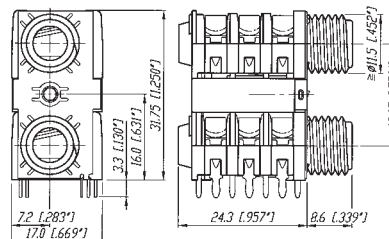

NRJ-NUT-B

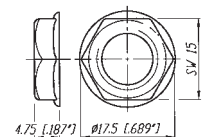

Specifications

	Vertical Jack	Locking Cable & Chassis Jack	M Jack	Slim Jack	Stacking Jack
--	---------------	------------------------------	--------	-----------	---------------

Electrical

Contact resistance	- initial	< 10 mΩ	< 6 mΩ	< 15 mΩ	< 10 mΩ	-
	- Top row	-	-	-	-	< 15 mΩ
	- Bottom row	-	-	-	-	< 10 mΩ
Switch contact resistance	- for silver	-	-	< 30 mΩ	< 25 mΩ	-
	- for gold	< 15 mΩ	-	-	< 10 mΩ	-
	- Top row	-	-	-	-	< 15 mΩ
	- Bottom row	-	-	-	-	< 10 mΩ
Insulation resistance	≥ 1GΩ @ 500 V dc	●	●	●	●	●
Dielectric strength	1 kV dc	●	●	●	●	●
Rated current		3 A	10 A	3 A	3 A	3 A
Rated switch contact current		0.25 A @ 12 V	N/A	0.5 A @ 50 V	0.5 A @ 50 V	0.5 A @ 50 V

Mechanical

Lifetime	> 10'000 cycles	●	●	●	●	●
Insertion / withdrawal force		< 10 N / > 8 N	< 20 N / < 20N	< 20 N / > 10 N	< 20 N / > 10 N	< 20 N / > 10 N
Cap opening torque		25 N cm / 9.84 N in	-	-	-	-
Locking force		-	> 80 N	-	-	-
Wire size		-	1 mm ² / 18 AWG [Ⓞ]	-	-	-
Cable O.D. (FC6 only)		-	3.5 - 8.0 mm	-	-	-
Panel thickness		1.2 - 1.5 mm [0.047 - 0.06"]	-	-	-	-
	- Full nose type	-	-	< 3.0 mm	< 3.0 mm	-
	- Half nose type	-	-	< 1.0 mm	< 1.0 mm	-
	- Chrome nose	-	-	< 4.7 mm	-	-
	- NSJ*HL	-	-	-	-	1.0 - 1.6 mm
	- NSJ*HC	-	-	-	-	> 1.0 mm

Material

Shell / Handle		PA 6.6 30% GR	ZnAl4Cu1 Ni or black	PA 6.6 15% GR	PA 6 15% GR	PA 6 15% GR
	- FP6P	-	PA 6.6 30% GR	-	-	-
Insulation		-	PA 6.6 30% GR	-	-	-
Contacts		CuSn6	CuBe2/CuZn37 (ground)	Ni-Silver	CuSn6	CuSn6
Contact surface		0.2 μm Au	2 μm Ag	-	gal 2 μm Ag / 0.2 μm Au	gal 2 μm Ag
Cap / Nut / Washer		POM	-	PA 6.6 15% GR	PA 6.6 15% GR	PA 6.6 15% GR
Ring Nut		-	-	-	Brass (Ni plated)	Brass (Ni plated)
Chuck		-	POM	-	-	-
Bushing		-	PA 6.6 15% GR + PUR	-	-	-
Temperature range	-25°C to +70°C	●	●	●	●	●

Ⓞ... max. for soldering tag

Environmental

Solderability complies with IEC 68-2-20		●	●	●	●	●
Standard Compatibility						
EIA RS 453 + IEC 60603-11		NJ*FD	●	●	●	●
B-GAUGE BPO 316, MIL-J-641/3		NJ*TB	-	-	-	-

Circuits:

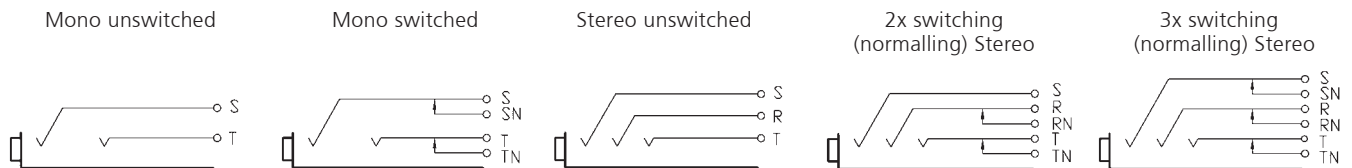

Part Number	Shell	Contacts	Terminations	Standards Compatibility	Remarks
-------------	-------	----------	--------------	-------------------------	---------

Slim Jack

PCB Mount Sockets - Switched

NRJ3HF-1	Black/Plastic	Silver	Horizontal PCB mount	IEC 60603-11/EIA RS 453	Mono, full threaded nose, chassis ground contact
NRJ4HF	●	●	●	●	Mono, full threaded nose
NRJ4HF-1	●	●	●	●	Mono, full threaded nose, chassis ground contact
NRJ6HF	●	●	●	●	Stereo, full threaded nose
NRJ6HF-1	●	●	●	●	Stereo, full threaded nose, chassis ground contact
NRJ4HH	●	●	●	●	Mono, half threaded nose
NRJ4HH-1	●	●	●	●	Mono, half threaded nose, chassis ground contact
NRJ6HH	●	●	●	●	Stereo, half threaded nose
NRJ6HH-1	●	●	●	●	Stereo, half threaded nose, chassis ground contact
NRJ6HF-AU	●	Gold	●	●	Stereo, full threaded nose, gold plated contacts
NRJ6HF-1-AU	●	Gold	●	●	Stereo, full threaded nose, chassis ground contact, gold plated contacts
NRJ6HH-AU	●	Gold	●	●	Stereo, half threaded nose, gold plated contacts
NRJ-NUT-B	●	-	-	-	Hexagonal black plastic nut
NRJ-NUT-R	Red/Plastic	-	-	-	Hexagonal red plastic nut
NRJ-NUT-MK	Metal/Ni plated	-	-	-	Metal ring nut, knurled
NRJ-NUT-MS	Metal/Ni plated	-	-	-	Metal ring nut

PCB Mount Sockets - Switched with Metal Nose

NRJ4HM-1	Black/Plastic	Silver	Horizontal PCB mount	IEC 60603-11/EIA RS 453	Mono, metal threaded nose
NRJ4HM-1-AU	●	Gold	●	●	Mono, metal threaded nose, gold plated contacts
NRJ6HM-1	●	Silver	●	●	Stereo, metal threaded nose
NRJ6HM-1-AU	●	Gold	●	●	Stereo, metal threaded nose, gold plated contacts
NRJ-NUT-MN	Metal	-	-	-	Hexagonal metal nut (for metal nose jack only)

Stacking Jack

NSJ8HL	Polyamid PA 6.6 GR	Silver	Horizontal PCB mount	IEC 60603-11/EIA RS 453	Mono, quick fix nose
NSJ12HL	●	●	●	●	Stereo, quick fix nose
NSJ8HC	●	●	●	●	Mono, full nose
NSJ12HC	●	●	●	●	Stereo, full nose
NSJ12HF-1	●	●	●	●	Full threaded nose
NSJ12HH-1	●	●	●	●	Half threaded nose
NSJ-NUT-B	Black/Plastic	-	-	-	Quick fix nut

All Slim jacks are for PCB mount only.

Mounting nuts must be ordered separately, except for Stacking Jack type NSJ8HL and NSJ12HL.

Ordering Key:

NRJ*H	NEUTRIK Jack Horizontal	*	number of contacts:
H	half threaded nose	2	mono unswitched
F	full threaded nose	4	mono switched
L	quick fix nose	6	stereo switched
M	metal threaded nose	8	mono stacking jack
C	plane nose	12	stereo stacking jack
-1	chassis ground contact		

Nose:

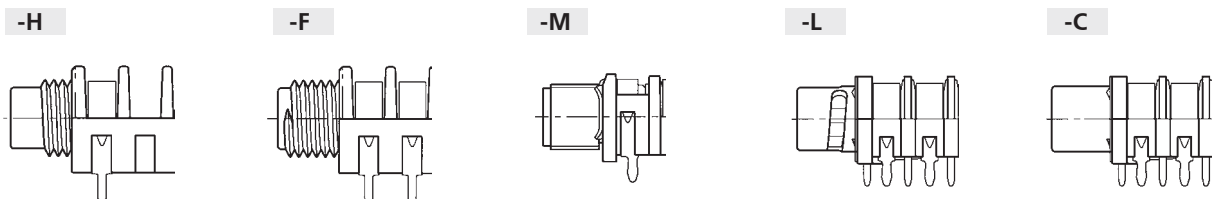

Part Number	Shell	Contacts	Terminations	Standards Compatibility	Remarks
-------------	-------	----------	--------------	----------------------------	---------

1/4" Locking Jack

NJ3FC6	Nickel	Silver	Wire soldering	IEC 60603-11/EIA RS 453	Cable Jack
NJ3FC6-BAG	Black	•	•	•	•
NJ3FP6C	Nickel	•	•	•	Chassis Jack
NJ3FP6C-B	Black	Gold	•	•	•
NJ3FP6C-BAG	Black	Silver	•	•	•
NJ3FP6F-P	Nickel	•	•	•	•
NJ3FP6F-BAG	Black/Plastic	•	•	•	Plastic Chassis

Accessories



DSS



SCDR



NDJ

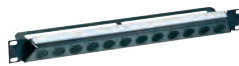

SCDX



SCDP-*

NZP1RU	Panel 1RU D-shape housing			SCDX	Hinged cover seals locking 1/4 chassis jack, IP42 rated
DSS-*	Lettering plate, colored plastic			SCDP-*	D-Size sealing gaskets, color coding
SCDR	Rear end protection cover for locking 1/4" chassis jack				(*: 0- black, 2- red, 4- yellow, 5- green, 6- blue, 9- white)
NDJ	dummyPLUG for 1/4" chassis jack				

1/4" Vertical Jack

NJ2FD-V	Black/Plastic	Gold	Vertical PCB mount	IEC 60603-11/EIA RS 453	Non-switching Mono Jack (T/S)
NJ3FD-V	•	•	•	•	Non-switching Stereo Jack (T/R/S)
NJ5FD-V	•	•	•	•	2 x switching (normalling) Stereo jack (T/TN/R/RN/S)
NJ6FD-V	•	•	•	•	3 x switching (normalling) Stereo jack (T/TN/R/RN/S/SN)
NJ6TB-V	•	•	•	B-Gauge BPO316 Mil-J-641/3	3 x switching (normalling) Stereo jack (T/TN/R/RN/S/SN)

M Jack

NMJ2HF-S	Black/Plastic	Silver	Horizontal PCB mount	IEC 60603-11/EIA RS 453	Mono, unswitched, full threaded nose, solder tags
NMJ3HF-S	•	•	•	•	Stereo, unswitched, full threaded nose, solder tags
NMJ4HF-S	•	•	•	•	Mono, switched, full threaded nose, solder tags
NMJ2HC-S	•	•	•	•	Mono, unswitched, Chrome ferrule, solder tags
NMJ4HC-S	•	•	•	•	Mono, switched, Chrome ferrule, solder tags
NMJ4HFD2	•	•	•	•	Mono, switched, full threaded nose, PCB mount
NMJ4HFD3	•	•	•	•	Mono, switched, full threaded nose, offset PCB mount
NMJ4HCD2	•	•	•	•	Mono, switched, Chrome ferrule, PCB mount,
NMJ4HHD2	•	•	•	•	Mono, switched, half threaded nose, PCB mount, without nut and washer
NMJ6HF-S	•	•	•	•	Stereo, switched, full threaded nose, solder tags
NMJ6HC-S	•	•	•	•	Stereo, switched, Chrome ferrule, solder tags
NMJ6HCD2	•	•	•	•	Stereo, switched, Chrome ferrule, PCB mount
NMJ6HHD2	•	•	•	•	Stereo, switched, half threaded nose, PCB mount, without nut and washer
NMJ6HFD2	•	•	•	•	Stereo, switched, full threaded nose, PCB mount
NMJ6HFD3	•	•	•	•	Stereo, switched, full threaded nose, offset PCB mount
NMJ6HCD3	•	•	•	•	Stereo, switched, Chrome ferrule, offset PCB mount
NMJ6HFD4	•	•	•	•	Stereo, switched, full threaded nose, tear drop PCB mount

Full threaded and Chrome nose M-Jacks are supplied with fixing nut and washers. Mounting hardware for half threaded nose must be ordered separately.

Ordering Key:

NMJ*H	NEUTRIK M Jack Horizontal	*	number of contacts:
H	half threaded nose	2	mono unswitched
F	fully threaded nose	3	stereo unswitched
C	chrome nose	4	mono switched
-S	solder tag	5	stereo switched (T/S)
D2	PCB pins 02	6	stereo switched (T/R/S)
D3	PCB pins 03		
D4	PCB pins 04		

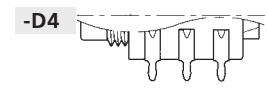
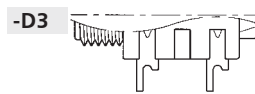
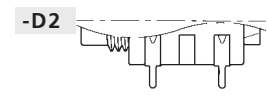
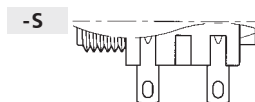



Gold plated contacts



Soft-touch surface



Phono socket

Profi® RCA Series

Phono Socket



NF2C-B2



NF2D-4



NF2D-B-6

- Makes ground before signal contact and breaks signal before ground
- No more disturbing noise and broken speaker cones
- Precisely machined to our demanding quality standards
- Neutrik unique chuck type strain relief
- Gold plated contacts
- Sleek barrel with soft touch surface and coloured shrink sleeve
- Improved ground solder lug for ease soldering

- Makes ground before signal contact and breaks signal before ground
- No more disturbing noise and broken speaker cones
- Precisely machined to our demanding quality standards
- Gold plated contacts

NF2C-B2

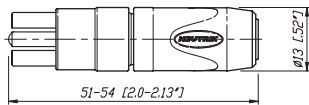

NF2D-*

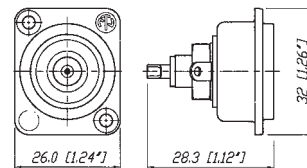

*: available in 9 colors see page 55

Specification		Profi®	Phono Socket
---------------	--	--------	--------------

Electrical

Rated current per contact	16 A rms continuous	●	●
Rated insulation voltage	50 V ac	●	●
Insulation resistance		> 100 GΩ	< 5 GΩ
Dielectric strength		1.5 kV dc	0.5 kV dc
Capacitance (pin to shell)		7 pf	9 pf

Mechanical

Life time (mating cycles)	> 2000	●	●
Cable O.D. range	3.0 - 7.3 mm	●	-
Wiring	soldering	●	●
Max. wire size	2.5 mm ² / 14 AWG	●	-
Cable anchoring	Neutrik® chuck type strain relief	●	-

Material

Housing	Brass (CuZn39Pb3)	●	-
	Zinc diecast (ZnAlCu1)	-	●
Insert	PBTP 20% GR	●	-
Contacts	Brass (CuZn39Pb3)	●	●
Contact plating	5 μm Au plated over 5 μm Ni	●	●
Chuck	Polyacetal (POM)	●	-

Environment

Temperature range	-30°C to +80°C	●	●
Protection class	IP 40	●	●
Flammability	UL 94 HB	●	●
Solderability	complies with IEC 68-2-20	●	●

Ordering Information

Phono Profi®

NF2C-B2	Professional "phono Plug" (RCA or CINCH type), two plugs with red and black coding, two strain relief chucks for a second cable diameter
---------	--

Phono (RCA) Socket

NF2D-*	Chassis Phono (RCA) socket in D Shape housing
NF2D-B-*	Chassis Phono (RCA) socket in black D Shape housing
* color coding: 0 - Black, 1 - Brown, 2 - Red, 3 - Orange, 4 - Yellow, 5 - Green, 6 - Blue, 7 - Violet, 8 - Grey, 9 - White	

Accessories

NDP	Dummy plug for phone socket
NZP1RU	Panel 1RU D-shape housing
SCL	Plastic sealing cover to protect the connector sockets against dust and moisture
SCDP-*	D-Size sealing gaskets, colour coding (*: 0- black, 2- red, 4- yellow, 5- green, 6- blue, 9- white)
SCDX	Hinged cover seals D-size chassis connectors, IP54 rated





Компания «ЭлектроПласт» предлагает заключение долгосрочных отношений при поставках импортных электронных компонентов на взаимовыгодных условиях!

Наши преимущества:

- Оперативные поставки широкого спектра электронных компонентов отечественного и импортного производства напрямую от производителей и с крупнейших мировых складов;
- Поставка более 17-ти миллионов наименований электронных компонентов;
- Поставка сложных, дефицитных, либо снятых с производства позиций;
- Оперативные сроки поставки под заказ (от 5 рабочих дней);
- Экспресс доставка в любую точку России;
- Техническая поддержка проекта, помощь в подборе аналогов, поставка прототипов;
- Система менеджмента качества сертифицирована по Международному стандарту ISO 9001;
- Лицензия ФСБ на осуществление работ с использованием сведений, составляющих государственную тайну;
- Поставка специализированных компонентов (Xilinx, Altera, Analog Devices, Intersil, Interpoint, Microsemi, Aeroflex, Peregrine, Syfer, Eurofarad, Texas Instrument, Miteq, Cobham, E2V, MA-COM, Hittite, Mini-Circuits, General Dynamics и др.);

Помимо этого, одним из направлений компании «ЭлектроПласт» является направление «Источники питания». Мы предлагаем Вам помощь Конструкторского отдела:

- Подбор оптимального решения, техническое обоснование при выборе компонента;
- Подбор аналогов;
- Консультации по применению компонента;
- Поставка образцов и прототипов;
- Техническая поддержка проекта;
- Защита от снятия компонента с производства.



Как с нами связаться

Телефон: 8 (812) 309 58 32 (многоканальный)

Факс: 8 (812) 320-02-42

Электронная почта: org@eplast1.ru

Адрес: 198099, г. Санкт-Петербург, ул. Калинина, дом 2, корпус 4, литера А.