

SN74AHCT16245 16-Bit Bus Transceivers With 3-State Outputs

1 Features

- Members of Texas Instruments' Widebus™ Family
- Inputs are TTL-Voltage Compatible
- Distributed V_{CC} and GND Pins Minimize High-Speed Switching Noise
- Flow-Through Architecture Optimizes PCB Layout
- Latch-Up Performance Exceeds 250 mA Per JESD 17

2 Applications

- Telecom and Wireless Infrastructures
- Electronic Points of Sale
- Printers and Other Peripherals
- Motor Drives
- Health and Fitness

4 Simplified Schematic

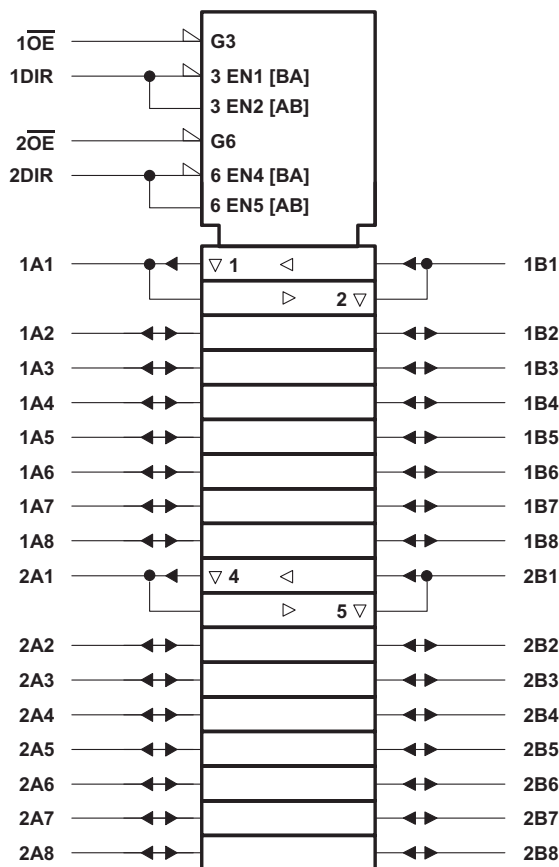

† This symbol is in accordance with ANSI/IEEE Std 91-1984 and IEC Publication 617-12.

3 Description

The SN74AHCT16245 device is a 16-bit (dual-octal) noninverting 3-state transceiver designed for synchronous two-way communication between data buses.

Device Information⁽¹⁾

PART NUMBER	PACKAGE	BODY SIZE (NOM)
SN74AHCT16245	TVSOP (48)	9.70 mm x 4.40 mm
	SSOP (48)	15.80 mm x 7.50 mm
	TSSOP (48)	12.50 mm x 6.10 mm

(1) For all available packages, see the orderable addendum at the end of the data sheet.



Table of Contents

1 Features	1	9 Detailed Description	9
2 Applications	1	9.1 Overview	9
3 Description	1	9.2 Functional Block Diagrams	9
4 Simplified Schematic	1	9.3 Feature Description	10
5 Revision History	2	9.4 Device Functional Modes	10
6 Pin Configuration and Functions	3	10 Application and Implementation	11
7 Specifications	5	10.1 Application Information	11
7.1 Absolute Maximum Ratings	5	10.2 Typical Application	11
7.2 Handling Ratings	5	11 Power Supply Recommendations	12
7.3 Recommended Operating Conditions	5	12 Layout	12
7.4 Thermal Information	6	12.1 Layout Guidelines	12
7.5 Electrical Characteristics	6	12.2 Layout Example	12
7.6 Switching Characteristics	7	13 Device and Documentation Support	13
7.7 Noise Characteristics	7	13.1 Trademarks	13
7.8 Operating Characteristics	7	13.2 Electrostatic Discharge Caution	13
7.9 Typical Characteristics	7	13.3 Glossary	13
8 Parameter Measurement Information	8	14 Mechanical, Packaging, and Orderable Information	13

5 Revision History

Changes from Revision J (October 2000) to Revision K

Page

• Updated document to new TI data sheet format.	1
• Deleted Ordering Information table.	1
• Deleted SN54AHCT16245 device from data sheet.	1
• Added Applications.	1
• Added Pin Functions table.	3
• Added Handling Ratings table.	5
• Changed MAX operating temperature to 125°C in Recommended Operating Conditions table.	5
• Added Thermal Information table.	6
• Added –40°C to 125°C range for SN74AHCT16245 in Electrical Characteristics table.	6
• Added $T_A = -40^\circ\text{C}$ to 125°C for SN74AHCT16245 in the Switching Characteristics table.	7
• Added Typical Characteristics.	7
• Added Detailed Description section.	9
• Added Application and Implementation section.	11
• Added Power Supply Recommendations and Layout sections.	12

6 Pin Configuration and Functions

SN74AHCT16245 . . . DGG, DGV, OR DL PACKAGE
(TOP VIEW)

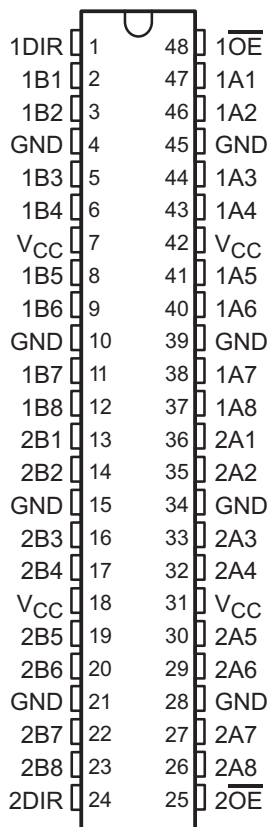

Pin Functions

PIN		I/O	DESCRIPTION
NO.	NAME		
1	1DIR	I	Direction pin 1
2	1B1	I/O	1B1 input or output
3	1B2	I/O	1B2 input or output
4	GND	—	Ground pin
5	1B3	I/O	1B3 input or output
6	1B4	I/O	1B4 input or output
7	V _{CC}	—	Power pin
8	1B5	I/O	1B5 input or output
9	1B6	I/O	1B6 input or output
10	GND	—	Ground pin
11	1B7	I/O	1B7 input or output
12	1B8	I/O	1B8 input or output
13	2B1	I/O	2B1 input or output
14	2B2	I/O	2B2 input or output
15	GND	—	Ground pin
16	2B3	I/O	2B3 input or output
17	2B4	I/O	2B4 input or output
18	V _{CC}	—	Power pin

Pin Functions (continued)

PIN		I/O	DESCRIPTION
NO.	NAME		
19	2B5	I/O	2B5 input or output
20	2B6	I/O	2B6 input or output
21	GND	—	Ground pin
22	2B7	I/O	2B7 input or output
23	2B8	I/O	2B8 input or output
24	2DIR	—	Direction pin 2
25	$\overline{2OE}$	I	Output Enable 2
26	2A8	I/O	2A8 input or output
27	2A7	I/O	2A7 input or output
28	GND	—	Ground pin
29	2A6	I/O	2A6 input or output
30	2A5	I/O	2A5 input or output
31	V _{CC}	—	Power pin
32	2A4	I/O	2A4 input or output
33	2A3	I/O	2A3 input or output
34	GND	—	Ground pin
35	2A2	I/O	2A2 input or output
36	2A1	I/O	2A1 input or output
37	1A8	I/O	1A8 input or output
38	1A7	I/O	1A7 input or output
39	GND	—	Ground pin
40	1A6	I/O	1A6 input or output
41	1A5	I/O	1A5 input or output
42	V _{CC}	—	Power pin
43	1A4	I/O	1A4 input or output
44	1A3	I/O	1A3 input or output
45	GND	—	Ground pin
46	1A2	I/O	1A2 input or output
47	1A1	I/O	1A1 input or output
48	$\overline{1OE}$	I	Output Enable 1

7 Specifications

7.1 Absolute Maximum Ratings

over operating free-air temperature range (unless otherwise noted)⁽¹⁾

				MIN	MAX	UNIT
V_{CC}	Supply voltage range			-0.5	7	V
V_I	Control Inputs	Input voltage range ⁽²⁾		-0.5	7	V
V_O	I/O	Output voltage range ⁽²⁾		-0.5	$V_{CC} + 0.5$	V
I_{IK}	Control Inputs	Input clamp current	$V_I < 0$		-20	mA
I_{OK}	I/O	Output clamp current	$V_O < 0$ or $V_O > V_{CC}$		±20	mA
I_O	Continuous output current		$V_O = 0$ to V_{CC}		±25	mA
Continuous current through V_{CC} or GND					±75	mA

- (1) Stresses beyond those listed under *Absolute Maximum Ratings* may cause permanent damage to the device. These are stress ratings only, which do not imply functional operation of the device at these or any other conditions beyond those indicated under *Recommended Operating Conditions*. Exposure to absolute-maximum-rated conditions for extended periods may affect device reliability.
- (2) The input and output voltage ratings may be exceeded if the input and output current ratings are observed.

7.2 Handling Ratings

				MIN	MAX	UNIT
T_{stg}	Storage temperature range			-65	150	°C
$V_{(ESD)}$	Electrostatic discharge	Human body model (HBM), per ANSI/ESDA/JEDEC JS-001, all pins ⁽¹⁾		0	1500	V
		Charged device model (CDM), per JEDEC specification JESD22-C101, all pins ⁽²⁾		0	2000	

- (1) JEDEC document JEP155 states that 500-V HBM allows safe manufacturing with a standard ESD control process.
- (2) JEDEC document JEP157 states that 250-V CDM allows safe manufacturing with a standard ESD control process.

7.3 Recommended Operating Conditions

over operating free-air temperature range (unless otherwise noted)⁽¹⁾

				SN74AHCT16245		UNIT
				MIN	MAX	
V_{CC}	Supply voltage			4.5	5.5	V
V_{IH}	High-level input voltage			2		V
V_{IL}	Low-level input voltage				0.8	V
V_I	Input voltage			0	5.5	V
V_{IO}	Input/Output voltage, A or B pins			0	V_{CC}	V
I_{OH}	High-level output current				-8	mA
I_{OL}	Low-level output current				8	mA
$\Delta t/\Delta v$	Input transition rise or fall rate				20	ns/V
T_A	Operating free-air temperature			-40	125	°C

- (1) All unused inputs of the device must be held at V_{CC} or GND to ensure proper device operation. Refer to the TI Application Report, *Implications of Slow or Floating CMOS Inputs (SCBA004)*.

7.4 Thermal Information

THERMAL METRIC ⁽¹⁾		SN74AHCT16245			UNIT
		DGG	DGV	DL	
		48 PINS			
R _{θJA}	Junction-to-ambient thermal resistance	68.1	79.3	61.0	°C/W
R _{θJC(top)}	Junction-to-case (top) thermal resistance	22.6	31.3	30.8	
R _{θJB}	Junction-to-board thermal resistance	35.0	42.3	32.8	
ψ _{JT}	Junction-to-top characterization parameter	1.3	2.4	8.4	
ψ _{JB}	Junction-to-board characterization parameter	34.7	41.8	32.5	
R _{θJC(bot)}	Junction-to-case (bottom) thermal resistance	n/a	n/a	n/a	

(1) For more information about traditional and new thermal metrics, see the *IC Package Thermal Metrics* application report ([SPRA953](#)).

7.5 Electrical Characteristics

over recommended operating free-air temperature range (unless otherwise noted)

PARAMETER	TEST CONDITIONS	V _{CC}	T _A = 25°C			SN74AHCT16245		–40°C to 125°C SN74AHCT16245		UNIT
			MIN	TYP	MAX	MIN	MAX	MIN	MAX	
V _{OH}	I _{OH} = –50 μA	4.5 V	4.4	4.5		4.4		4.4	V	
	I _{OH} = –8 mA		3.94			3.8		3.8		
V _{OL}	I _{OL} = 50 μA	4.5 V			0.1			0.1	V	
	I _{OL} = 8 mA				0.36			0.44		
I _I	$\overline{\text{OE}}$ or DIR	V _I = V _{CC} or GND			±0.1			±1	μA	
I _{OZ} ⁽¹⁾	A or B Inputs	V _O = V _{CC} or GND			±0.25			±2.5	μA	
I _{CC}		V _I = V _{CC} or GND, I _O = 0			4			40	μA	
ΔI _{CC} ⁽²⁾		One input at 3.4 V, Other inputs at V _{CC} or GND			1.35			1.5	mA	
C _i	$\overline{\text{OE}}$ or DIR	V _I = V _{CC} or GND		2.5	10			10	pF	
C _{io}	A or B Inputs			4					pF	

(1) For I/O ports, the parameter I_{OZ} includes the input leakage current.

(2) This is the increase in supply current for each input at one of the specified TTL voltage levels, rather than 0 V or V_{CC}.

7.6 Switching Characteristics

over recommended operating free-air temperature range, $V_{CC} = 5 V \pm 0.5 V$ (unless otherwise noted) (see Figure 2)

PARAMETER	FROM (INPUT)	TO (OUTPUT)	LOAD CAPACITANCE	$T_A = 25^\circ C$		SN74AHCT16245		$T_A = -40^\circ C$ to $125^\circ C$ SN74AHCT16245		UNIT
				TYP	MAX	MIN	MAX	MIN	MAX	
t_{PLH}	A or B	B or A	$C_L = 15 pF$	4.5 ⁽¹⁾	8.5 ⁽¹⁾	1	9.5	1	11	ns
t_{PHL}				4.5 ⁽¹⁾	8.5 ⁽¹⁾	1	9.5	1	11	
t_{PZH}	\overline{OE}	A or B	$C_L = 15 pF$	8.9 ⁽¹⁾	13 ⁽¹⁾	1	14	1	15	ns
t_{PZL}				8.9 ⁽¹⁾	13 ⁽¹⁾	1	14	1	15	
t_{PHZ}	\overline{OE}	A or B	$C_L = 15 pF$	9.2 ⁽¹⁾	14 ⁽¹⁾	1	15	1	15.7	ns
t_{PLZ}				9.2 ⁽¹⁾	14 ⁽¹⁾	1	15	1	15.7	
t_{PLH}	A or B	B or A	$C_L = 50 pF$	7	9.5	1	10.5	1	12	ns
t_{PHL}				5.3	9.5	1	10.5	1	12	
t_{PZH}	\overline{OE}	A or B	$C_L = 50 pF$	8.3	14	1	15	1	16	ns
t_{PZL}				8.3	14	1	15	1	16	
t_{PHZ}	\overline{OE}	A or B	$C_L = 50 pF$	8	14	1	15	1	15.7	ns
t_{PLZ}				8	14	1	15	1	15.7	
$t_{sk(o)}$			$C_L = 50 pF$		1 ⁽²⁾		1		1	ns

(1) On products compliant to MIL-PRF-38535, this parameter is not production tested.

(2) On products compliant to MIL-PRF-38535, this parameter does not apply.

7.7 Noise Characteristics

$V_{CC} = 5 V$, $C_L = 50 pF$, $T_A = 25^\circ C$ ⁽¹⁾

PARAMETER	DESCRIPTION	SN74AHCT16245			UNIT
		MIN	TYP	MAX	
$V_{OL(P)}$	Quiet output, maximum dynamic V_{OL}		0.6	0.8	V
$V_{OL(V)}$	Quiet output, minimum dynamic V_{OL}		-0.6	-0.8	V
$V_{OH(V)}$	Quiet output, minimum dynamic V_{OH}		4.8		V
$V_{IH(D)}$	High-level dynamic input voltage	2			V
$V_{IL(D)}$	Low-level dynamic input voltage			0.8	V

(1) Characteristics are for surface-mount packages only.

7.8 Operating Characteristics

$V_{CC} = 5 V$, $T_A = 25^\circ C$

PARAMETER	TEST CONDITIONS	TYP	UNIT
C_{pd}	No load, $f = 1 MHz$	17	pF

7.9 Typical Characteristics

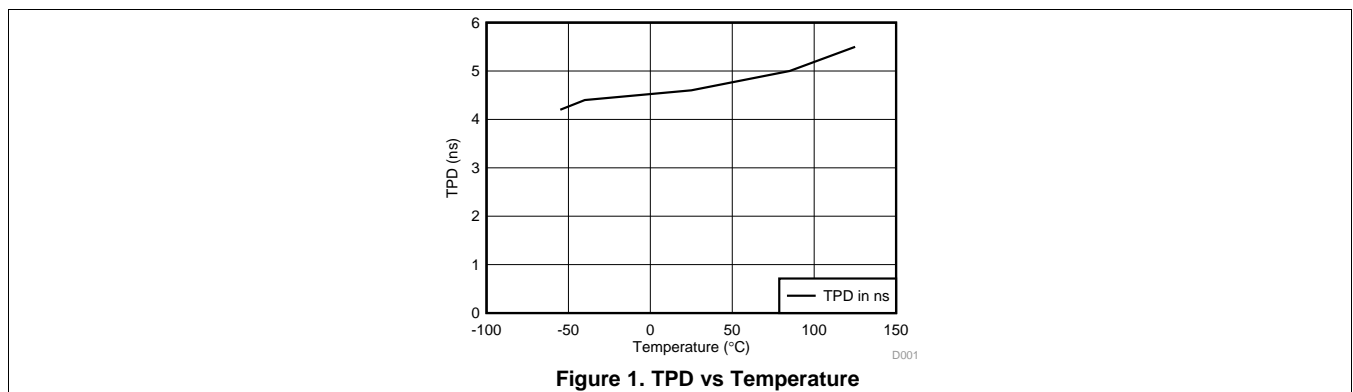
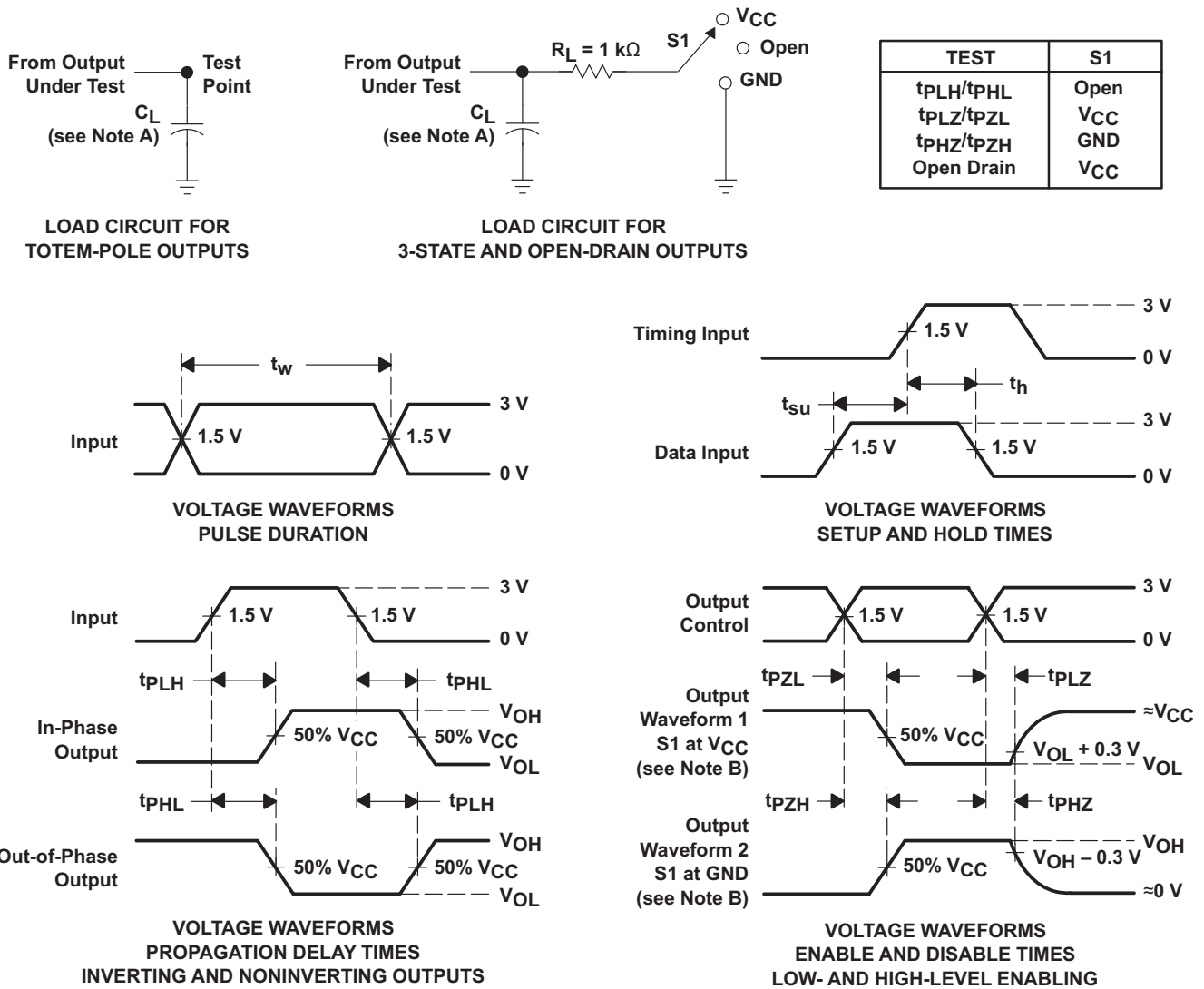

Figure 1. TPD vs Temperature

8 Parameter Measurement Information



- NOTES: A. C_L includes probe and jig capacitance.
 B. Waveform 1 is for an output with internal conditions such that the output is low except when disabled by the output control. Waveform 2 is for an output with internal conditions such that the output is high except when disabled by the output control.
 C. All input pulses are supplied by generators having the following characteristics: PRR $\leq 1\text{ MHz}$, $Z_O = 50\ \Omega$, $t_r \leq 3\text{ ns}$, $t_f \leq 3\text{ ns}$.
 D. The outputs are measured one at a time with one input transition per measurement.

Figure 2. Load Circuit and Voltage Waveforms

9 Detailed Description

9.1 Overview

The SN74AHCT16245 device is a 16-bit (dual-octal) noninverting 3-state transceiver designed for synchronous two-way communication between data buses. The control-function implementation minimizes external timing requirements.

This device can be used as two 8-bit transceivers or one 16-bit transceiver. It allows data transmission from the A bus to the B bus or from the B bus to the A bus, depending on the logic level at the direction-control (DIR) input. The output-enable (\overline{OE}) input can be used to disable the device so that the buses are effectively isolated.

To ensure the high-impedance state during power up or power down, \overline{OE} should be tied to V_{CC} through a pullup resistor; the minimum value of the resistor is determined by the current-sinking capability of the driver.

9.2 Functional Block Diagrams

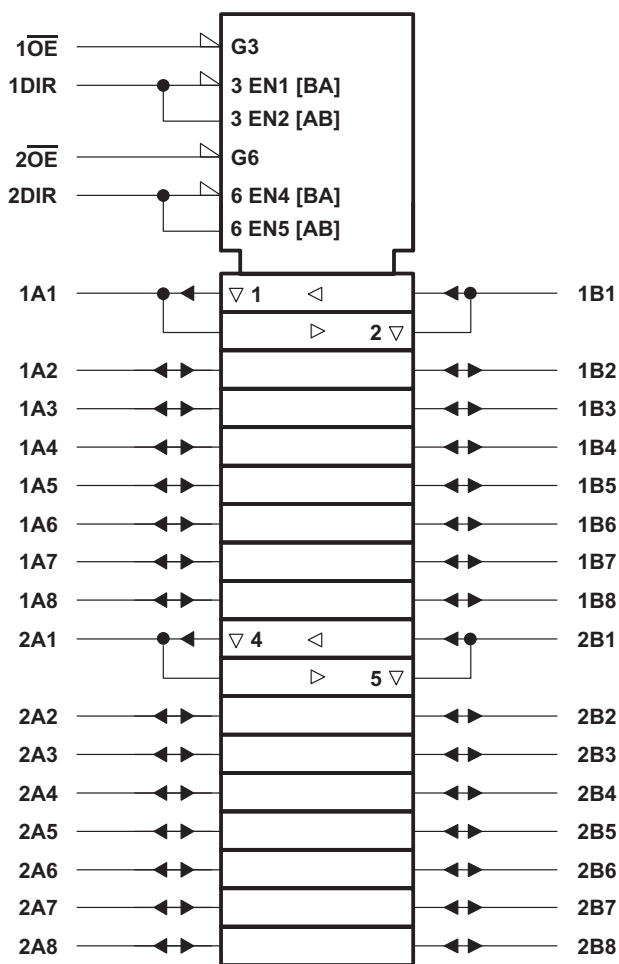

A. † This symbol is in accordance with ANSI/IEEE Std 91-1984 and IEC Publication 617-12.

Figure 3. Logic Symbol

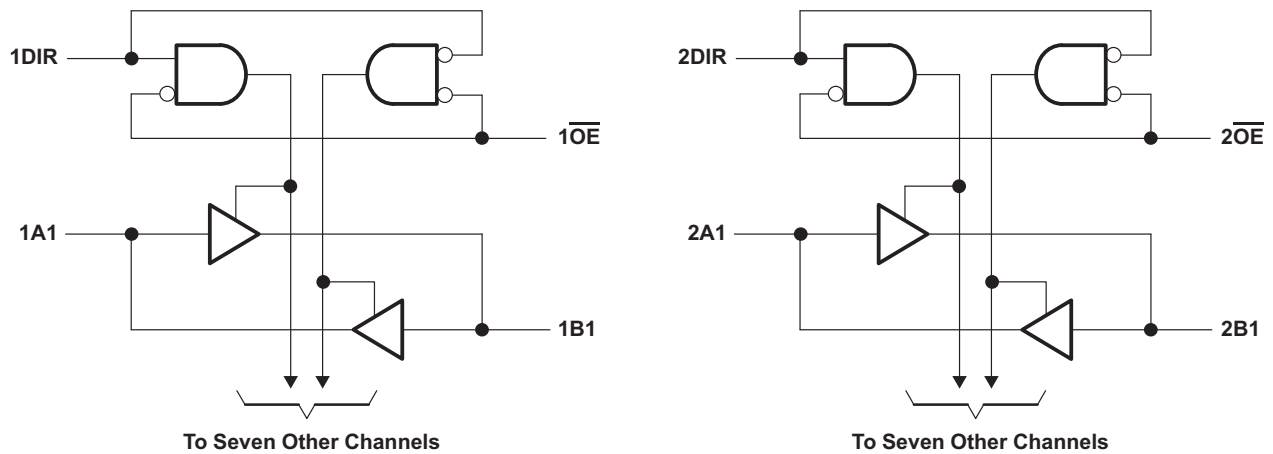
Functional Block Diagrams (continued)

Figure 4. Logic Diagram (Positive Logic)
9.3 Feature Description

- TTL inputs
 - Lowered switching threshold allows up translation 3.3 V to 5 V
- Slow edges reduce output ringing

9.4 Device Functional Modes
**Table 1. Function Table
(Each 8-bit Transceiver)**

INPUTS		OPERATION
\overline{OE}	DIR	
L	L	B data to A bus
L	H	A data to B bus
H	X	Isolation

10 Application and Implementation

10.1 Application Information

The SN74AHCT16245 is a low-drive CMOS device that can be used for a multitude of bus interface type applications where output ringing is a concern. The low drive and slow edge rates will minimize overshoot and undershoot on the outputs. The input switching levels have been lowered to accommodate TTL inputs of 0.8-V V_{IL} and 2-V V_{IH} . This feature makes the device ideal for translating up from 3.3 V to 5 V. Figure 6 shows this type of translation.

10.2 Typical Application

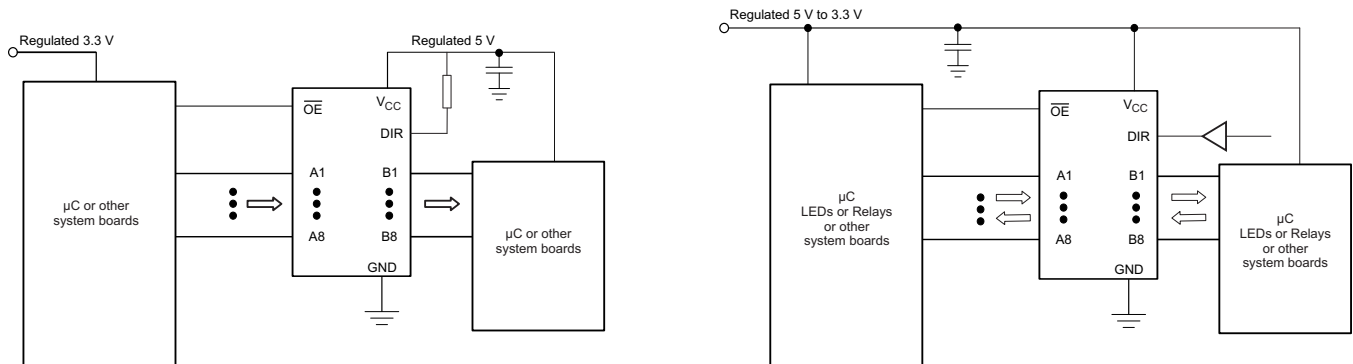

Figure 5. Typical Application Diagram

10.2.1 Design Requirements

This device uses CMOS technology and has balanced output drive. Care should be taken to avoid bus contention because it can drive currents that would exceed maximum limits. The high drive will also create fast edges into light loads; therefore, routing and load conditions should be considered to prevent ringing.

10.2.2 Detailed Design Procedure

1. Recommended Input Conditions:
 - For rise time and fall time specifications, see $\Delta t/\Delta V$ in the [Recommended Operating Conditions](#) table.
 - For specified high and low levels, see V_{IH} and V_{IL} in the [Recommended Operating Conditions](#) table.
 - Inputs are overvoltage tolerant allowing them to go as high as 5.5 V at any valid V_{CC} .
2. Recommend Output Conditions:
 - Load currents should not exceed 25 mA per output and 75 mA total for the part.
 - Outputs should not be pulled above V_{CC} .

Typical Application (continued)

10.2.3 Application Curves

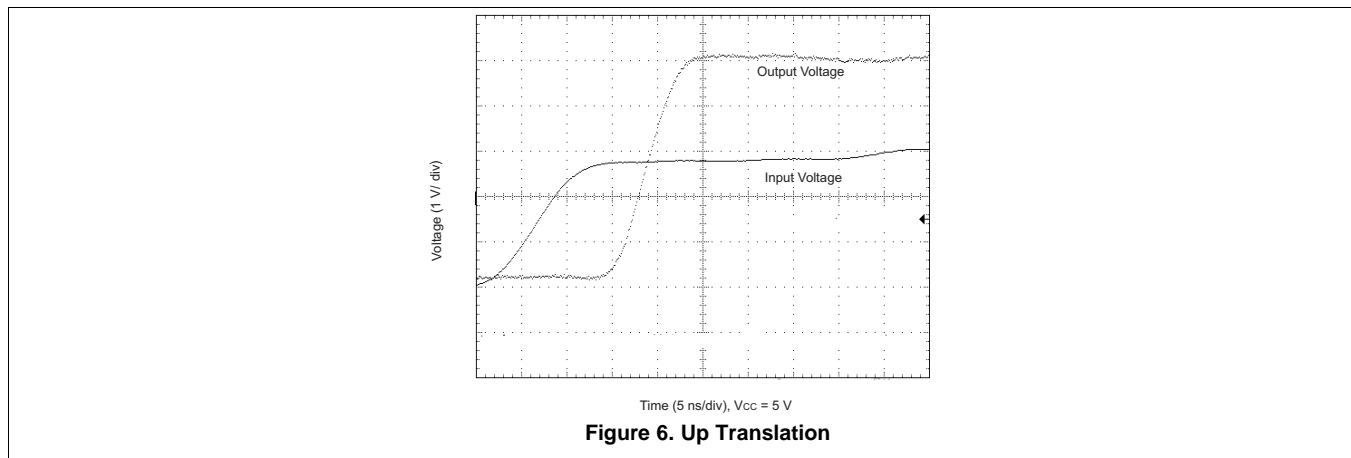

11 Power Supply Recommendations

The power supply can be any voltage between the MIN and MAX supply voltage rating located in the [Recommended Operating Conditions](#) table.

Each V_{CC} pin should have a good bypass capacitor to prevent power disturbance. For devices with a single supply, 0.1 μF is recommended and if there are multiple V_{CC} pins than 0.01 μF or 0.022 μF is recommended for each power pin. It is acceptable to parallel multiple bypass caps to reject different frequencies of noise. A 0.1 μF and 1 μF are commonly used in parallel. The bypass capacitor should be installed as close to the power pin as possible for best results.

12 Layout

12.1 Layout Guidelines

When using multiple bit logic devices, inputs should not float. In many cases, functions or parts of functions of digital logic devices are unused. Some examples are when only two inputs of a triple-input AND gate are used, or when only 3 of the 4-buffer gates are used. Such input pins should not be left unconnected because the undefined voltages at the outside connections result in undefined operational states.

Specified in [Figure 7](#) are rules that must be observed under all circumstances. All unused inputs of digital logic devices must be connected to a high or low bias to prevent them from floating. The logic level that should be applied to any particular unused input depends on the function of the device. Generally they will be tied to GND or V_{CC} , whichever makes more sense or is more convenient. It is acceptable to float outputs unless the part is a transceiver.

12.2 Layout Example

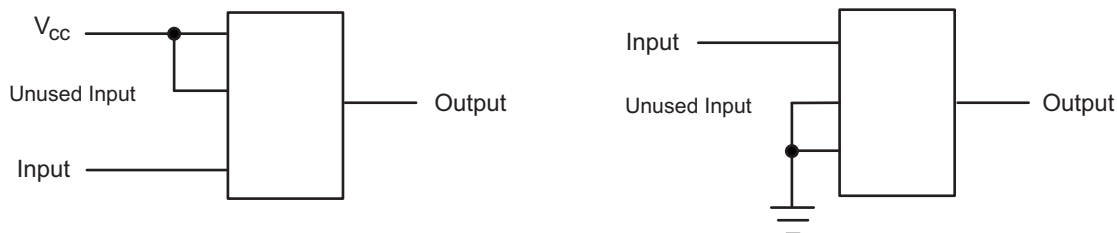

Figure 7. Layout Diagram

13 Device and Documentation Support

13.1 Trademarks

Widebus is a trademark of Texas Instruments.
All other trademarks are the property of their respective owners.

13.2 Electrostatic Discharge Caution



These devices have limited built-in ESD protection. The leads should be shorted together or the device placed in conductive foam during storage or handling to prevent electrostatic damage to the MOS gates.

13.3 Glossary

[SLYZ022](#) — *TI Glossary*.

This glossary lists and explains terms, acronyms, and definitions.

14 Mechanical, Packaging, and Orderable Information

The following pages include mechanical, packaging, and orderable information. This information is the most current data available for the designated devices. This data is subject to change without notice and revision of this document. For browser-based versions of this data sheet, refer to the left-hand navigation.

PACKAGING INFORMATION

Orderable Device	Status (1)	Package Type	Package Drawing	Pins	Package Qty	Eco Plan (2)	Lead/Ball Finish (6)	MSL Peak Temp (3)	Op Temp (°C)	Device Marking (4/5)	Samples
74AHCT16245DGVRE4	ACTIVE	TVSOP	DGV	48	2000	Green (RoHS & no Sb/Br)	CU NIPDAU	Level-1-260C-UNLIM	-40 to 125	HF245	Samples
74AHCT16245DLRG4	ACTIVE	SSOP	DL	48	1000	Green (RoHS & no Sb/Br)	CU NIPDAU	Level-1-260C-UNLIM	-40 to 125	AHCT16245	Samples
SN74AHCT16245DGGR	ACTIVE	TSSOP	DGG	48	2000	Green (RoHS & no Sb/Br)	CU NIPDAU	Level-1-260C-UNLIM	-40 to 125	AHCT16245	Samples
SN74AHCT16245DGVR	ACTIVE	TVSOP	DGV	48	2000	Green (RoHS & no Sb/Br)	CU NIPDAU	Level-1-260C-UNLIM	-40 to 125	HF245	Samples
SN74AHCT16245DL	ACTIVE	SSOP	DL	48	25	Green (RoHS & no Sb/Br)	CU NIPDAU	Level-1-260C-UNLIM	-40 to 125	AHCT16245	Samples
SN74AHCT16245DLG4	ACTIVE	SSOP	DL	48	25	Green (RoHS & no Sb/Br)	CU NIPDAU	Level-1-260C-UNLIM	-40 to 125	AHCT16245	Samples
SN74AHCT16245DLR	ACTIVE	SSOP	DL	48	1000	Green (RoHS & no Sb/Br)	CU NIPDAU	Level-1-260C-UNLIM	-40 to 125	AHCT16245	Samples

(1) The marketing status values are defined as follows:

ACTIVE: Product device recommended for new designs.

LIFEBUY: TI has announced that the device will be discontinued, and a lifetime-buy period is in effect.

NRND: Not recommended for new designs. Device is in production to support existing customers, but TI does not recommend using this part in a new design.

PREVIEW: Device has been announced but is not in production. Samples may or may not be available.

OBSOLETE: TI has discontinued the production of the device.

(2) Eco Plan - The planned eco-friendly classification: Pb-Free (RoHS), Pb-Free (RoHS Exempt), or Green (RoHS & no Sb/Br) - please check <http://www.ti.com/productcontent> for the latest availability information and additional product content details.

TBD: The Pb-Free/Green conversion plan has not been defined.

Pb-Free (RoHS): TI's terms "Lead-Free" or "Pb-Free" mean semiconductor products that are compatible with the current RoHS requirements for all 6 substances, including the requirement that lead not exceed 0.1% by weight in homogeneous materials. Where designed to be soldered at high temperatures, TI Pb-Free products are suitable for use in specified lead-free processes.

Pb-Free (RoHS Exempt): This component has a RoHS exemption for either 1) lead-based flip-chip solder bumps used between the die and package, or 2) lead-based die adhesive used between the die and leadframe. The component is otherwise considered Pb-Free (RoHS compatible) as defined above.

Green (RoHS & no Sb/Br): TI defines "Green" to mean Pb-Free (RoHS compatible), and free of Bromine (Br) and Antimony (Sb) based flame retardants (Br or Sb do not exceed 0.1% by weight in homogeneous material)

(3) MSL, Peak Temp. - The Moisture Sensitivity Level rating according to the JEDEC industry standard classifications, and peak solder temperature.

(4) There may be additional marking, which relates to the logo, the lot trace code information, or the environmental category on the device.

⁽⁵⁾ Multiple Device Markings will be inside parentheses. Only one Device Marking contained in parentheses and separated by a "-" will appear on a device. If a line is indented then it is a continuation of the previous line and the two combined represent the entire Device Marking for that device.

⁽⁶⁾ Lead/Ball Finish - Orderable Devices may have multiple material finish options. Finish options are separated by a vertical ruled line. Lead/Ball Finish values may wrap to two lines if the finish value exceeds the maximum column width.

Important Information and Disclaimer:The information provided on this page represents TI's knowledge and belief as of the date that it is provided. TI bases its knowledge and belief on information provided by third parties, and makes no representation or warranty as to the accuracy of such information. Efforts are underway to better integrate information from third parties. TI has taken and continues to take reasonable steps to provide representative and accurate information but may not have conducted destructive testing or chemical analysis on incoming materials and chemicals. TI and TI suppliers consider certain information to be proprietary, and thus CAS numbers and other limited information may not be available for release.

In no event shall TI's liability arising out of such information exceed the total purchase price of the TI part(s) at issue in this document sold by TI to Customer on an annual basis.

TAPE AND REEL INFORMATION



QUADRANT ASSIGNMENTS FOR PIN 1 ORIENTATION IN TAPE



*All dimensions are nominal

Device	Package Type	Package Drawing	Pins	SPQ	Reel Diameter (mm)	Reel Width W1 (mm)	A0 (mm)	B0 (mm)	K0 (mm)	P1 (mm)	W (mm)	Pin1 Quadrant
SN74AHCT16245DGGR	TSSOP	DGG	48	2000	330.0	24.4	8.6	15.8	1.8	12.0	24.0	Q1
SN74AHCT16245DGVR	TVSOP	DGV	48	2000	330.0	16.4	7.1	10.2	1.6	12.0	16.0	Q1
SN74AHCT16245DLR	SSOP	DL	48	1000	330.0	32.4	11.35	16.2	3.1	16.0	32.0	Q1

TAPE AND REEL BOX DIMENSIONS

*All dimensions are nominal

Device	Package Type	Package Drawing	Pins	SPQ	Length (mm)	Width (mm)	Height (mm)
SN74AHCT16245DGGR	TSSOP	DGG	48	2000	367.0	367.0	45.0
SN74AHCT16245DGVR	TVSOP	DGV	48	2000	367.0	367.0	38.0
SN74AHCT16245DLR	SSOP	DL	48	1000	367.0	367.0	55.0

DGV (R-PDSO-G**)

PLASTIC SMALL-OUTLINE

24 PINS SHOWN



4073251/E 08/00

- NOTES: A. All linear dimensions are in millimeters.
 B. This drawing is subject to change without notice.
 C. Body dimensions do not include mold flash or protrusion, not to exceed 0,15 per side.
 D. Falls within JEDEC: 24/48 Pins – MO-153
 14/16/20/56 Pins – MO-194

DGG (R-PDSO-G**)

PLASTIC SMALL-OUTLINE PACKAGE

48 PINS SHOWN



- NOTES: A. All linear dimensions are in millimeters.
 B. This drawing is subject to change without notice.
 C. Body dimensions do not include mold protrusion not to exceed 0,15.
 D. Falls within JEDEC MO-153

IMPORTANT NOTICE

Texas Instruments Incorporated and its subsidiaries (TI) reserve the right to make corrections, enhancements, improvements and other changes to its semiconductor products and services per JESD46, latest issue, and to discontinue any product or service per JESD48, latest issue. Buyers should obtain the latest relevant information before placing orders and should verify that such information is current and complete. All semiconductor products (also referred to herein as "components") are sold subject to TI's terms and conditions of sale supplied at the time of order acknowledgment.

TI warrants performance of its components to the specifications applicable at the time of sale, in accordance with the warranty in TI's terms and conditions of sale of semiconductor products. Testing and other quality control techniques are used to the extent TI deems necessary to support this warranty. Except where mandated by applicable law, testing of all parameters of each component is not necessarily performed.

TI assumes no liability for applications assistance or the design of Buyers' products. Buyers are responsible for their products and applications using TI components. To minimize the risks associated with Buyers' products and applications, Buyers should provide adequate design and operating safeguards.

TI does not warrant or represent that any license, either express or implied, is granted under any patent right, copyright, mask work right, or other intellectual property right relating to any combination, machine, or process in which TI components or services are used. Information published by TI regarding third-party products or services does not constitute a license to use such products or services or a warranty or endorsement thereof. Use of such information may require a license from a third party under the patents or other intellectual property of the third party, or a license from TI under the patents or other intellectual property of TI.

Reproduction of significant portions of TI information in TI data books or data sheets is permissible only if reproduction is without alteration and is accompanied by all associated warranties, conditions, limitations, and notices. TI is not responsible or liable for such altered documentation. Information of third parties may be subject to additional restrictions.

Resale of TI components or services with statements different from or beyond the parameters stated by TI for that component or service voids all express and any implied warranties for the associated TI component or service and is an unfair and deceptive business practice. TI is not responsible or liable for any such statements.

Buyer acknowledges and agrees that it is solely responsible for compliance with all legal, regulatory and safety-related requirements concerning its products, and any use of TI components in its applications, notwithstanding any applications-related information or support that may be provided by TI. Buyer represents and agrees that it has all the necessary expertise to create and implement safeguards which anticipate dangerous consequences of failures, monitor failures and their consequences, lessen the likelihood of failures that might cause harm and take appropriate remedial actions. Buyer will fully indemnify TI and its representatives against any damages arising out of the use of any TI components in safety-critical applications.

In some cases, TI components may be promoted specifically to facilitate safety-related applications. With such components, TI's goal is to help enable customers to design and create their own end-product solutions that meet applicable functional safety standards and requirements. Nonetheless, such components are subject to these terms.

No TI components are authorized for use in FDA Class III (or similar life-critical medical equipment) unless authorized officers of the parties have executed a special agreement specifically governing such use.

Only those TI components which TI has specifically designated as military grade or "enhanced plastic" are designed and intended for use in military/aerospace applications or environments. Buyer acknowledges and agrees that any military or aerospace use of TI components which have **not** been so designated is solely at the Buyer's risk, and that Buyer is solely responsible for compliance with all legal and regulatory requirements in connection with such use.

TI has specifically designated certain components as meeting ISO/TS16949 requirements, mainly for automotive use. In any case of use of non-designated products, TI will not be responsible for any failure to meet ISO/TS16949.

Products

Audio	www.ti.com/audio
Amplifiers	amplifier.ti.com
Data Converters	dataconverter.ti.com
DLP® Products	www.dlp.com
DSP	dsp.ti.com
Clocks and Timers	www.ti.com/clocks
Interface	interface.ti.com
Logic	logic.ti.com
Power Mgmt	power.ti.com
Microcontrollers	microcontroller.ti.com
RFID	www.ti-rfid.com
OMAP Applications Processors	www.ti.com/omap
Wireless Connectivity	www.ti.com/wirelessconnectivity

Applications

Automotive and Transportation	www.ti.com/automotive
Communications and Telecom	www.ti.com/communications
Computers and Peripherals	www.ti.com/computers
Consumer Electronics	www.ti.com/consumer-apps
Energy and Lighting	www.ti.com/energy
Industrial	www.ti.com/industrial
Medical	www.ti.com/medical
Security	www.ti.com/security
Space, Avionics and Defense	www.ti.com/space-avionics-defense
Video and Imaging	www.ti.com/video

TI E2E Community

e2e.ti.com



Компания «ЭлектроПласт» предлагает заключение долгосрочных отношений при поставках импортных электронных компонентов на взаимовыгодных условиях!

Наши преимущества:

- Оперативные поставки широкого спектра электронных компонентов отечественного и импортного производства напрямую от производителей и с крупнейших мировых складов;
- Поставка более 17-ти миллионов наименований электронных компонентов;
- Поставка сложных, дефицитных, либо снятых с производства позиций;
- Оперативные сроки поставки под заказ (от 5 рабочих дней);
- Экспресс доставка в любую точку России;
- Техническая поддержка проекта, помощь в подборе аналогов, поставка прототипов;
- Система менеджмента качества сертифицирована по Международному стандарту ISO 9001;
- Лицензия ФСБ на осуществление работ с использованием сведений, составляющих государственную тайну;
- Поставка специализированных компонентов (Xilinx, Altera, Analog Devices, Intersil, Interpoint, Microsemi, Aeroflex, Peregrine, Syfer, Eurofarad, Texas Instrument, Miteq, Cobham, E2V, MA-COM, Hittite, Mini-Circuits, General Dynamics и др.);

Помимо этого, одним из направлений компании «ЭлектроПласт» является направление «Источники питания». Мы предлагаем Вам помощь Конструкторского отдела:

- Подбор оптимального решения, техническое обоснование при выборе компонента;
- Подбор аналогов;
- Консультации по применению компонента;
- Поставка образцов и прототипов;
- Техническая поддержка проекта;
- Защита от снятия компонента с производства.



Как с нами связаться

Телефон: 8 (812) 309 58 32 (многоканальный)

Факс: 8 (812) 320-02-42

Электронная почта: org@eplast1.ru

Адрес: 198099, г. Санкт-Петербург, ул. Калинина, дом 2, корпус 4, литера А.