



## FEATURES

- Compact flat type**  
 Flat size enables it to be built-in switch units.  
 <Height>  
 PC board terminal type:  
 9.5 mm .374 inch  
 Surface-mount terminal type:  
 10.5mm .413inch
- High capacity**  
 CP Relay provides low profile spacesaving advantages while offering high continuous current of 25A (1 hour).
- Simple footprint pattern enables ease of PC board layout**  
 Arrangement of coil and contact terminals designed to withstand large capacity which ensures leeway and facilitates PC board design.

- Sealed construction**  
 Sealed construction suitable for harsh environments
- “PC board terminal” and “Surface mount terminal” types available**  
 SMD automatic mounting is possible for surface mount terminal types because tape and reel packaging is used.
- Model available for wiper load.**

## TYPICAL APPLICATIONS

**For automotive system**  
 Power windows, Auto door lock, Power sunroof, Memory seat, Wiper, Defogger, etc.

## ORDERING INFORMATION

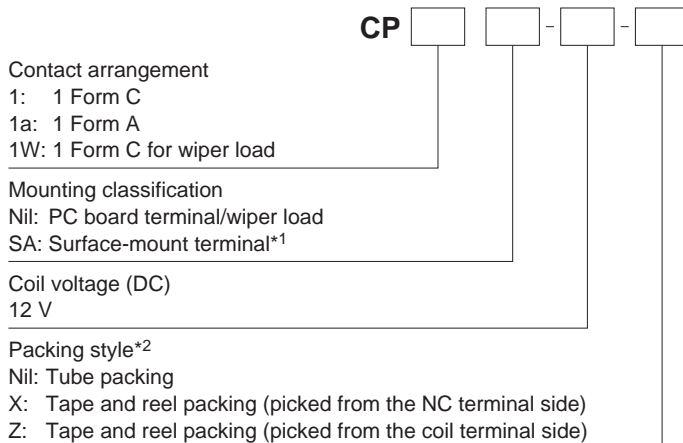

## TYPES

### 1. PC board terminal type

Contact arrangement	Coil voltage	Part No.
1 Form A	12V DC	CP1a-12V
1 Form C		CP1-12V
1 Form C for wiper load		CP1W-12V

Standard packing; Carton (tube): 40 pcs.; Case: 1,000 pcs.

### 2. Surface mount terminal type

Contact arrangement	Coil voltage	Part No.
1 Form C	12V DC	CP1SA-12V-X
		CP1SA-12V-Z

Standard packing; Carton (tape and reel): 300 pcs.; Case: 900 pcs.

Notes:

\*1. Surface-mount terminal type is available only for 1 form C contact arrangement.

\*2. Surface mount terminal type is only supplied in tape and reel packaging. Tube packaging is only available for PC board type.

Tape and reel packing symbol “-z” or “-x” are not marked on the relay.

# RATING

## 1. Coil data

Nominal coil voltage	Pick-up voltage (at 20°C 68°F)	Drop-out voltage (at 20°C 68°F)	Nominal operating current [±10%] (at 20°C 68°F)	Coil resistance [±10%] (at 20°C 68°F)	Nominal operating power (at 20°C 68°F)	Usable voltage range (at 85°C 185°F)
12V DC	Max. 7.2V DC (Initial)	Min. 1.0V DC (Initial)	53.3 mA	225Ω	640 mW	10 to 16V DC

Note: Other pick-up voltage types are also available. Please contact us for details.

## 2. Specifications

### 1) Standard CP relay

Characteristics	Item	Specifications	
		1 Form A	1 Form C
Contact	Arrangement		
	Initial contact resistance (Initial)	N.O.: Typ6mΩ, N.C.: Typ8mΩ (By voltage drop 6V DC 1A)	
	Contact material	Ag alloy (Cadmium free)	
Rating	Nominal switching capacity (resistive load)	20A 14V DC	N.O.: 20A 14V DC, N.C.: 10A 14V DC
	Max. carrying current (12V DC initial)*3	N.O.: 40A for 2 minutes, 30A for 1 hour (at 20°C 68°F) 35A for 2 minutes, 25A for 1 hour (at 85°C 185°F)	
	Nominal operating power	640 mW	
	Min. switching capacity (resistive load)*1	1A 12V DC	
Electrical characteristics	Insulation resistance (Initial)	Min. 100 MΩ (at 500V DC)	
	Breakdown voltage (Initial)	Between open contacts	500 Vrms for 1 min. (Detection current: 10mA)
		Between contacts and coil	500 Vrms for 1 min. (Detection current: 10mA)
	Operate time (at nominal voltage)	Max. 10ms (at 20°C 68°F, excluding contact bounce time) (Initial)	
	Release time (at nominal voltage)	Max. 10ms (at 20°C 68°F, excluding contact bounce time) (Initial)	
Mechanical characteristics	Shock resistance	Functional	Min. 100 m/s <sup>2</sup> {10G} (Half-wave pulse of sine wave: 11ms; detection: 10μs)
		Destructive	Min. 1,000 m/s <sup>2</sup> {100G} (Half-wave pulse of sine wave: 6ms)
	Vibration resistance	Functional	10 Hz to 100 Hz, Min. 44.1 m/s <sup>2</sup> {4.5G} (Detection time: 10μs)
		Destructive	10 Hz to 500 Hz, Min. 44.1 m/s <sup>2</sup> {4.5G} Time of vibration for each direction; X, Y direction: 2 hours, Z direction: 4 hours
Expected life	Mechanical	Min. 10 <sup>7</sup> (at 120 cpm)	
	Electrical*4.	<Resistive load> Min. 10 <sup>5</sup> (At nominal switching capacity, operating frequency: 1s ON, 9s OFF) <Motor load*> Min. 2×10 <sup>5</sup> (N.O. side, Inrush 25A, steady 5A at 14V DC) Min. 10 <sup>5</sup> (N.O. side, 20A 14V DC at motor lock) Min. 2×10 <sup>5</sup> (N.C. side, 20A 14V DC at brake current) (Operating frequency: 0.5s ON, 9.5s OFF)	
Conditions	Conditions for operation, transport and storage*2	Ambient temp: -40°C to +85°C -40°F to +185°F Humidity: 5% R.H. to 85% R.H. (Not freezing and condensing at low temperature)	
	Max. operating speed	6 cpm (at rated load)	
Mass		Approx. 4g .14 oz	

Notes:

\*1. This value can change due to the switching frequency, environmental conditions, and desired reliability level, therefore it is recommended to check this with the actual load.

\*2. Refer to "6. Usage, Storage and Transport Conditions" in [AMBIENT ENVIRONMENT section in Relay Technical Information](#).

Please inquire if you will be using the relay in a high temperature atmosphere (110°C 230°F).

\*3. Depends on connection conditions. Also, this does not guarantee repeated switching. We recommend that you confirm operation under actual conditions.

\*4. Motor load does not apply to wiper load applications.

### 2) For wiper load (CP1W-12V)

Anything outside of that given below complies with standard CP relays.

Characteristics	Item	Specifications
Rating	Max. carrying current (12V DC initial)	N.O.: 25A for 1 minutes, 15A for 1 hour (at 20°C 68°F)
Expected life	Electrical	<Wiper motor load (L = Approx. 1mH)> N.O. side: Min. 5×10 <sup>5</sup> (Inrush 25A, steady 6A at 14V DC) N.C. side: Min. 5×10 <sup>5</sup> (12A 14V DC at brake current) (Operating frequency: 1s ON, 9s OFF)

Note:\*1. Depends on connection conditions. Also, this does not guarantee repeated switching. We recommend that you confirm operation under actual conditions.

# REFERENCE DATA

## 1.-(1) Coil temperature rise (at room temperature)

Sample: CP1-12V, 3pcs  
 Point measured: Inside the coil  
 Contact carrying current, 5A, 10A, 15A, 20A  
 Resistance method, ambient temperature 26°C 79°F

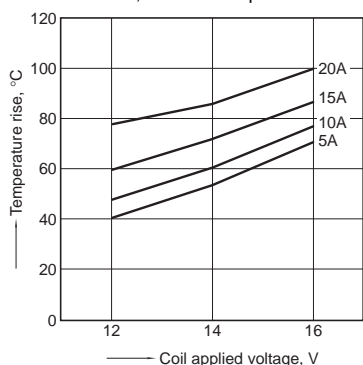

## 1.-(2) Coil temperature rise

Sample: CP1-12V, 6pcs  
 Point measured: Inside the coil  
 Contact carrying current, 5A, 10A, 15A, 20A  
 Resistance method, ambient temperature 85°C 185°F

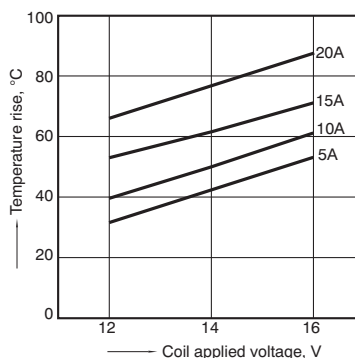

## 2. Max. switching capability (Resistive load, initial)

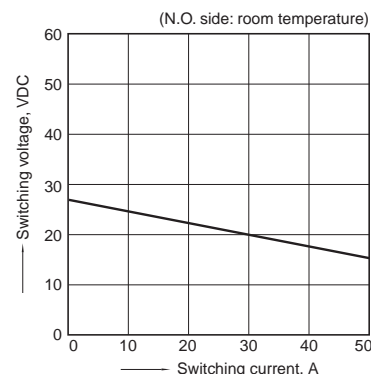

## 3. Ambient temperature and operating voltage range

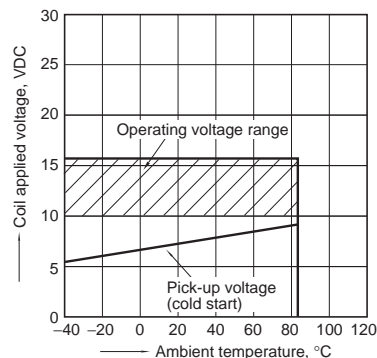

## 4. Distribution of pick-up and drop-out voltage

Sample: CP1-12V, 100pcs  
 Ambient temperature: 20°C 68°F

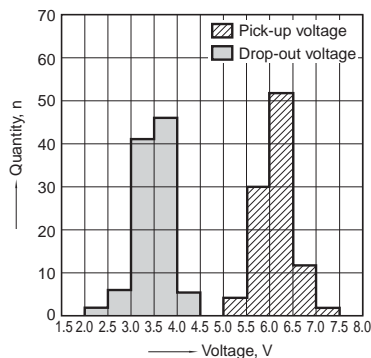

## 5. Distribution of operate time

Sample: CP1-12V, 100pcs  
 Ambient temperature: 20°C 68°F

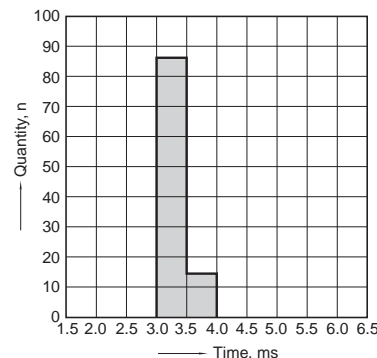

## 6. Distribution of release time

Sample: CP1-12V, 100pcs  
 Ambient temperature: 20°C 68°F  
 \* Without diode

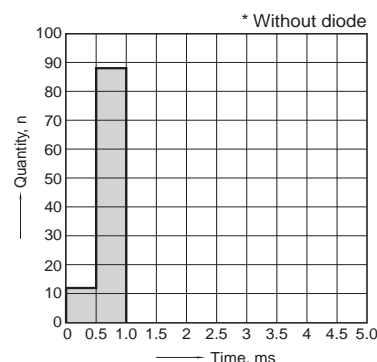

## 7.-(1) Electrical life test (at resistive load)

Sample: CP1-12V  
 Quantity: n = 4 (N.C. = 2, N.O. = 2)  
 Load: Resistive load (N.C. side: 10A 14V DC, N.O. side: 20A 14V DC)  
 Operating frequency: ON 1s, OFF 9s  
 Ambient temperature: Room temperature

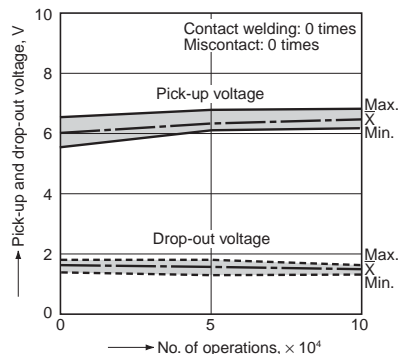

## 7.-(2) Electrical life test for wiper load (motor free)

Sample: CP1W-12V  
 Quantity: n = 5  
 Load: N.O. side: Inrush 25A, steady 6A 14V DC  
 Load: N.C. side: Brake current 12A 14V DC  
 Operating frequency: ON 1s, OFF 9s  
 Ambient temperature: Room temperature  
 Circuit

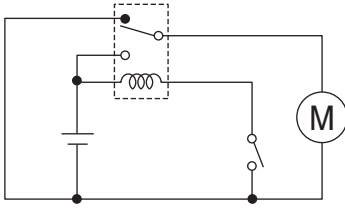

## Change of pick-up and drop-out voltage

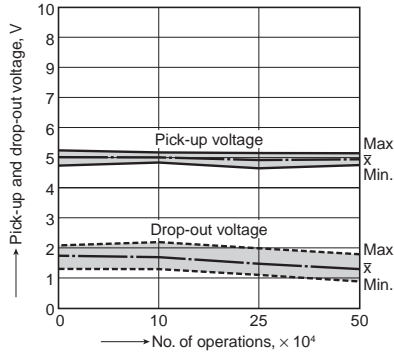

## Change of contact resistance

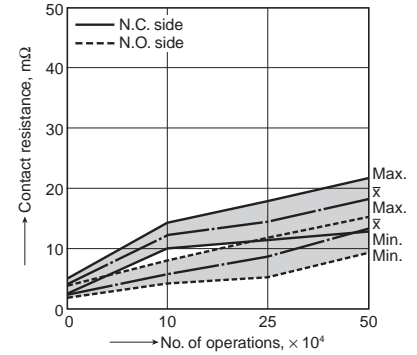

## DIMENSIONS (mm inch)

Download [CAD Data](#) from our Web site.

### 1. PC board terminal type

[CAD Data](#)



#### External dimensions

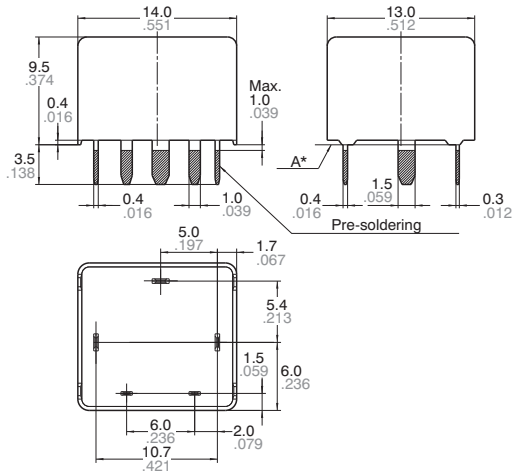

**Dimension:**  
 Max. 1mm .039 inch:  
 1 to 3mm .039 to .118 inch:  
 Min. 3mm .118 inch:

**Tolerance**  
 $\pm 0.1 \pm 0.004$   
 $\pm 0.2 \pm 0.008$   
 $\pm 0.3 \pm 0.012$

\* Dimensions (thickness and width) of terminal specified in this catalog is measured before pre-soldering. Intervals between terminals is measured at A surface level.

#### PC board pattern (Bottom view) 1 Form A

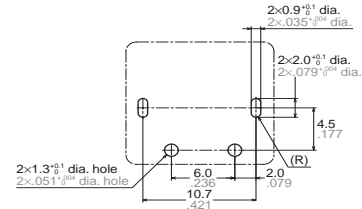

#### 1 Form C

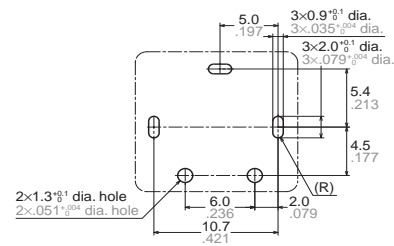

#### Schematic (Bottom view) 1 Form A

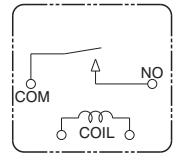

#### 1 Form C

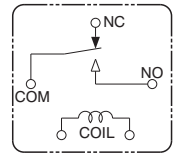

### 2. Surface mount terminal type

[CAD Data](#)



#### External dimensions

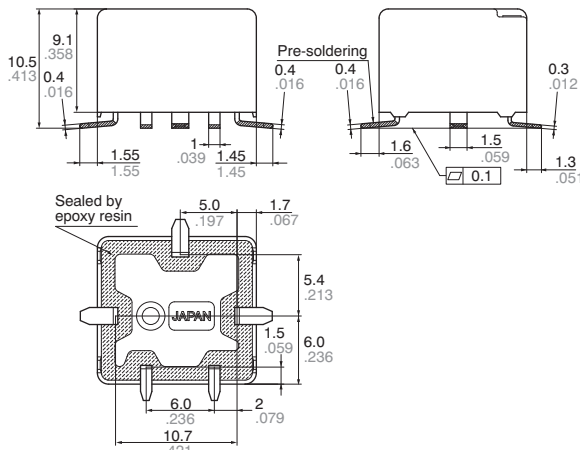

**Dimension:**  
 Max. 1mm .039 inch:  
 1 to 3mm .039 to .118 inch:  
 Min. 3mm .118 inch:

**Tolerance**  
 $\pm 0.1 \pm 0.004$   
 $\pm 0.2 \pm 0.008$   
 $\pm 0.3 \pm 0.012$

#### Recommendable mounting pad (Top view)

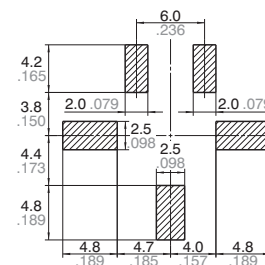

#### Schematic (Top view)

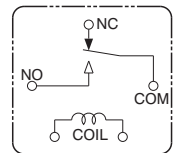

## NOTES

### 1. Mounting and cleaning conditions for SMT type relays

1) Recommended reflow condition is:

- Reflow-soldering temperature profile condition (IRS method)

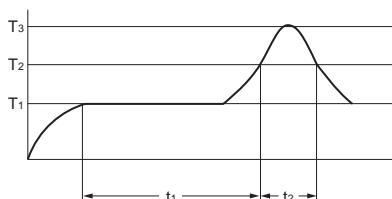

T<sub>1</sub> = 150 to 180°C 302 to 356°F  
 T<sub>2</sub> = 230°C 446°F or more  
 T<sub>3</sub> = Less than 260°C 500°F  
 t<sub>1</sub> = 60 to 120 sec.  
 t<sub>2</sub> = Less than 40 sec.

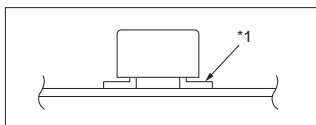

#### • Cautions for mounting operations

Temperature profile indicates the temperature of the soldered part (\*1) of terminals on the surface of a circuit board. The exterior temperature of a relay may be extremely high depending on the component density on the board or the heating method of the reflow oven or circuit board type. Sufficient verification under actual processing conditions is required.

2) Avoid cleaning (ultrasonic cleaning, boiling cleaning, etc.) and coating in order to prevent negative impacts on relay characteristics.

### 2. Storage condition after opening a moisture-prevention package

1) After opening a moisture-prevention package, use the item as soon as possible (within 3 days under an environment of Max. 30°C 86°F, Max. 70% RH).

2) If products are not used within 4 days after opening a moisture-prevention package, store them in a humidity-controlled desiccator or in a storage bag with silica gel.

**For Cautions for Use, see [Relay Technical Information](#).**



Компания «ЭлектроПласт» предлагает заключение долгосрочных отношений при поставках импортных электронных компонентов на взаимовыгодных условиях!

Наши преимущества:

- Оперативные поставки широкого спектра электронных компонентов отечественного и импортного производства напрямую от производителей и с крупнейших мировых складов;
- Поставка более 17-ти миллионов наименований электронных компонентов;
- Поставка сложных, дефицитных, либо снятых с производства позиций;
- Оперативные сроки поставки под заказ (от 5 рабочих дней);
- Экспресс доставка в любую точку России;
- Техническая поддержка проекта, помощь в подборе аналогов, поставка прототипов;
- Система менеджмента качества сертифицирована по Международному стандарту ISO 9001;
- Лицензия ФСБ на осуществление работ с использованием сведений, составляющих государственную тайну;
- Поставка специализированных компонентов (Xilinx, Altera, Analog Devices, Intersil, Interpoint, Microsemi, Aeroflex, Peregrine, Syfer, Eurofarad, Texas Instrument, Miteq, Cobham, E2V, MA-COM, Hittite, Mini-Circuits, General Dynamics и др.);

Помимо этого, одним из направлений компании «ЭлектроПласт» является направление «Источники питания». Мы предлагаем Вам помощь Конструкторского отдела:

- Подбор оптимального решения, техническое обоснование при выборе компонента;
- Подбор аналогов;
- Консультации по применению компонента;
- Поставка образцов и прототипов;
- Техническая поддержка проекта;
- Защита от снятия компонента с производства.



#### Как с нами связаться

**Телефон:** 8 (812) 309 58 32 (многоканальный)

**Факс:** 8 (812) 320-02-42

**Электронная почта:** [org@eplast1.ru](mailto:org@eplast1.ru)

**Адрес:** 198099, г. Санкт-Петербург, ул. Калинина, дом 2, корпус 4, литера А.