

FEATURES

High common-mode transient immunity: 100 kV/ μ s
 High robustness to radiated and conducted noise
 Low propagation delay

- 13 ns maximum for 5 V operation
- 15 ns maximum for 1.8 V operation

150 Mbps maximum guaranteed data rate

Safety and regulatory approvals

- UL recognition: 5000 V rms for 1 minute per UL 1577
- CSA Component Acceptance Notice 5A
- VDE certificate of conformity
- DIN V VDE V 0884-10 (VDE V 0884-10):2006-12
- $V_{IORM} = 849$ V peak
- 8000 V peak reinforced surge isolation voltage
- CQC certification per GB4943.1-2011

Backward compatibility

- ADuM240E1/ADuM241E1/ADuM242E1 pin compatible with ADuM2400/ADuM2401/ADuM2402

Low dynamic power consumption

- 1.8 V to 5 V level translation
- High temperature operation: 125°C

Fail-safe high or low options

- 16-lead, RoHS compliant, SOIC package
- Qualified for automotive applications

APPLICATIONS

- General-purpose multichannel isolation
- Serial peripheral interface (SPI)/data converter isolation
- Industrial field bus isolation

GENERAL DESCRIPTION

The ADuM240D/ADuM240E/ADuM241D/ADuM241E/ADuM242D/ADuM242E¹ are quad-channel digital isolators based on Analog Devices, Inc., iCoupler® technology. Combining high speed, complementary metal-oxide semiconductor (CMOS) and monolithic air core transformer technology, these isolation components provide outstanding performance characteristics superior to alternatives such as optocoupler devices and other integrated couplers. The maximum propagation delay is 13 ns with a pulse width distortion of less than 3 ns at 5 V operation. Channel matching is tight at 3.0 ns maximum.

The ADuM240D/ADuM240E/ADuM241D/ADuM241E/ADuM242D/ADuM242E data channels are independent and are available in a variety of configurations with a withstand voltage rating of 5.0 kV rms (see the Ordering Guide). The devices operate with the supply voltage on either side ranging from 1.8 V to 5 V, providing compatibility with lower voltage

¹ Protected by U.S. Patents 5,952,849; 6,873,065; 6,903,578; and 7,075,329. Other patents are pending.

Rev. D

Document Feedback

Information furnished by Analog Devices is believed to be accurate and reliable. However, no responsibility is assumed by Analog Devices for its use, nor for any infringements of patents or other rights of third parties that may result from its use. Specifications subject to change without notice. No license is granted by implication or otherwise under any patent or patent rights of Analog Devices. Trademarks and registered trademarks are the property of their respective owners.

FUNCTIONAL BLOCK DIAGRAMS

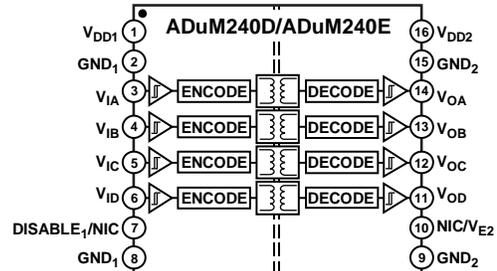

- NOTES
1. NIC = NO INTERNAL CONNECTION. LEAVE THIS PIN FLOATING.
 2. PIN 7 IS DISABLE₁ AND PIN 10 IS NIC FOR THE ADuM240D, AND PIN 7 IS NIC AND PIN 10 IS VE₂ FOR THE ADuM240E.

Figure 1. ADuM240D/ADuM240E Functional Block Diagram

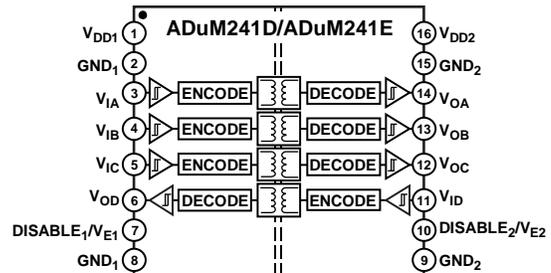

- NOTES
1. PIN 7 IS DISABLE₁ AND PIN 10 IS DISABLE₂ FOR THE ADuM241D, AND PIN 7 IS VE₁ AND PIN 10 IS VE₂ FOR THE ADuM241E.

Figure 2. ADuM241D/ADuM241E Functional Block Diagram

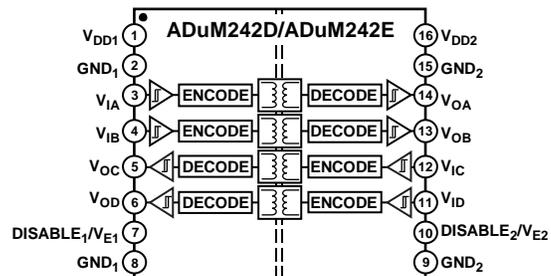

- NOTES
1. PIN 7 IS DISABLE₁ AND PIN 10 IS DISABLE₂ FOR THE ADuM242D, AND PIN 7 IS VE₁ AND PIN 10 IS VE₂ FOR THE ADuM242E.

Figure 3. ADuM242D/ADuM242E Functional Block Diagram

systems as well as enabling voltage translation functionality across the isolation barrier.

Unlike other optocoupler alternatives, dc correctness is ensured in the absence of input logic transitions. Two different fail-safe options are available, by which the outputs transition to a predetermined state when the input power supply is not applied or the inputs are disabled. The ADuM240E1/ADuM241E1/ADuM242E1 are pin compatible with the ADuM2400/ADuM2401/ADuM2402.

TABLE OF CONTENTS

| | | | |
|--|----|--|----|
| Features | 1 | Recommended Operating Conditions | 13 |
| Applications | 1 | Absolute Maximum Ratings | 14 |
| General Description | 1 | ESD Caution..... | 14 |
| Functional Block Diagrams..... | 1 | Pin Configurations and Function Descriptions | 16 |
| Revision History | 2 | Typical Performance Characteristics | 19 |
| Specifications..... | 3 | Theory of Operation | 21 |
| Electrical Characteristics—5 V Operation..... | 3 | Applications Information | 22 |
| Electrical Characteristics—3.3 V Operation | 5 | PCB Layout | 22 |
| Electrical Characteristics—2.5 V Operation | 7 | Propagation Delay Related Parameters | 22 |
| Electrical Characteristics—1.8 V Operation | 9 | Jitter Measurement..... | 22 |
| Insulation and Safety Related Specifications | 11 | Insulation Lifetime..... | 22 |
| Package Characteristics | 11 | Outline Dimensions | 24 |
| Regulatory Information..... | 12 | Ordering Guide | 24 |
| DIN V VDE V 0884-10 (VDE V 0884-10) Insulation | | Automotive Products..... | 26 |
| Characteristics | 13 | | |

REVISION HISTORY

11/2018—Rev. C to Rev. D

| | |
|--|----|
| Changes to Table 12 and Table 13 | 12 |
|--|----|

4/2018—Rev. B to Rev. C

| | |
|---|----|
| Change to Features Section | 1 |
| Changes to Table 12 and Table 13 | 12 |
| Changes to Ordering Guide | 24 |
| Changes to Automotive Products Section..... | 26 |

3/2018—Rev. A to Rev. B

| | |
|---|----|
| Updated Outline Dimensions | 24 |
| Changes to Ordering Guide | 24 |
| Change to Automotive Products Section | 26 |

4/2016—Rev. 0 to Rev. A

| | |
|---|-----------|
| Added RI-16-2 | Universal |
| Changes to Features Section | 1 |
| Changes to Table 1..... | 3 |
| Changes to Table 3..... | 5 |
| Changes to Table 5..... | 7 |
| Changes to Table 7..... | 9 |
| Added Table 10; Renumbered Sequentially | 11 |
| Added Table 13 | 12 |
| Added Table 18 | 14 |
| Updated Outline Dimensions | 23 |
| Added Figure 26 | 24 |
| Changes to Ordering Guide | 24 |
| Added Automotive Products Section | 26 |

9/2015—Revision 0: Initial Version

SPECIFICATIONS

ELECTRICAL CHARACTERISTICS—5 V OPERATION

All typical specifications are at $T_A = 25^\circ\text{C}$, $V_{DD1} = V_{DD2} = 5\text{ V}$. Minimum/maximum specifications apply over the entire recommended operation range of $4.5\text{ V} \leq V_{DD1} \leq 5.5\text{ V}$, $4.5\text{ V} \leq V_{DD2} \leq 5.5\text{ V}$, and $-40^\circ\text{C} \leq T_A \leq +125^\circ\text{C}$, unless otherwise noted. Switching specifications are tested with $C_L = 15\text{ pF}$ and CMOS signal levels, unless otherwise noted. Supply currents are specified with 50% duty cycle signals.

Table 1.

| Parameter | Symbol | Min | Typ | Max | Unit | Test Conditions/Comments |
|--|-----------------------|----------------------|-----------------|----------------------|---------------|--|
| SWITCHING SPECIFICATIONS | | | | | | |
| Pulse Width | PW | 6.6 | | | ns | Within pulse width distortion (PWD) limit |
| Data Rate ¹ | | 150 | | | Mbps | Within PWD limit |
| Propagation Delay | t_{PHL} , t_{PLH} | 4.8 | 7.2 | 13 | ns | 50% input to 50% output |
| Pulse Width Distortion | PWD | | 0.5 | 3 | ns | $ t_{PLH} - t_{PHL} $ |
| Change vs. Temperature | | | 1.5 | | ps/°C | |
| Propagation Delay Skew | t_{PSK} | | | 6.1 | ns | Between any two units at the same temperature, voltage, and load |
| Channel Matching | | | | | | |
| Codirectional | t_{PSKCD} | | 0.5 | 3.0 | ns | |
| Opposing Direction | t_{PSKOD} | | 0.5 | 3.0 | ns | |
| Jitter | | | 490 | | ps p-p | See the Jitter Measurement section |
| | | | 70 | | ps rms | See the Jitter Measurement section |
| DC SPECIFICATIONS | | | | | | |
| Input Threshold Voltage | | | | | | |
| Logic High | V_{IH} | $0.7 \times V_{DDx}$ | | | V | |
| Logic Low | V_{IL} | | | $0.3 \times V_{DDx}$ | V | |
| Output Voltage | | | | | | |
| Logic High | V_{OH} | $V_{DDx} - 0.1$ | V_{DDx} | | V | $I_{Ox}^2 = -20\text{ }\mu\text{A}$, $V_{ix} = V_{ixH}^3$ |
| | | $V_{DDx} - 0.4$ | $V_{DDx} - 0.2$ | | V | $I_{Ox}^2 = -4\text{ mA}$, $V_{ix} = V_{ixH}^3$ |
| Logic Low | V_{OL} | | 0.0 | 0.1 | V | $I_{Ox}^2 = 20\text{ }\mu\text{A}$, $V_{ix} = V_{ixL}^4$ |
| | | | 0.2 | 0.4 | V | $I_{Ox}^2 = 4\text{ mA}$, $V_{ix} = V_{ixL}^4$ |
| Input Current per Channel | I_i | -10 | +0.01 | +10 | μA | $0\text{ V} \leq V_{ix} \leq V_{DDx}$ |
| V_{E2} Enable Input Pull-Up Current | I_{PU} | -10 | -3 | | μA | $V_{E2} = 0\text{ V}$ |
| DISABLE ₁ Input Pull-Down Current | I_{PD} | | 9 | 15 | μA | DISABLE ₁ = V_{DDx} |
| Tristate Output Current per Channel | I_{OZ} | -10 | +0.01 | +10 | μA | $0\text{ V} \leq V_{Ox} \leq V_{DDx}$ |
| Quiescent Supply Current | | | | | | |
| ADuM240D/ADuM240E | | | | | | |
| | $I_{DD1(Q)}$ | | 1.2 | 2.2 | mA | $V_i^5 = 0$ (E0, D0), 1 (E1, D1) ⁶ |
| | $I_{DD2(Q)}$ | | 2.0 | 2.72 | mA | $V_i^5 = 0$ (E0, D0), 1 (E1, D1) ⁶ |
| | $I_{DD1(Q)}$ | | 12.0 | 20.0 | mA | $V_i^5 = 1$ (E0, D0), 0 (E1, D1) ⁶ |
| | $I_{DD2(Q)}$ | | 2.0 | 2.92 | mA | $V_i^5 = 1$ (E0, D0), 0 (E1, D1) ⁶ |
| ADuM241D/ADuM241E | | | | | | |
| | $I_{DD1(Q)}$ | | 1.6 | 2.46 | mA | $V_i^5 = 0$ (E0, D0), 1 (E1, D1) ⁶ |
| | $I_{DD2(Q)}$ | | 1.9 | 2.62 | mA | $V_i^5 = 0$ (E0, D0), 1 (E1, D1) ⁶ |
| | $I_{DD1(Q)}$ | | 10.0 | 17.0 | mA | $V_i^5 = 1$ (E0, D0), 0 (E1, D1) ⁶ |
| | $I_{DD2(Q)}$ | | 6.0 | 10.0 | mA | $V_i^5 = 1$ (E0, D0), 0 (E1, D1) ⁶ |
| ADuM242D/ADuM242E | | | | | | |
| | $I_{DD1(Q)}$ | | 1.6 | 2.46 | mA | $V_i^5 = 0$ (E0, D0), 1 (E1, D1) ⁶ |
| | $I_{DD2(Q)}$ | | 1.6 | 2.46 | mA | $V_i^5 = 0$ (E0, D0), 1 (E1, D1) ⁶ |
| | $I_{DD1(Q)}$ | | 7.0 | 11.5 | mA | $V_i^5 = 1$ (E0, D0), 0 (E1, D1) ⁶ |
| | $I_{DD2(Q)}$ | | 7.0 | 11.5 | mA | $V_i^5 = 1$ (E0, D0), 0 (E1, D1) ⁶ |
| Dynamic Supply Current | | | | | | |
| Dynamic Input | $I_{DD1(D)}$ | | 0.01 | | mA/Mbps | Inputs switching, 50% duty cycle |
| Dynamic Output | $I_{DDO(D)}$ | | 0.02 | | mA/Mbps | Inputs switching, 50% duty cycle |

| Parameter | Symbol | Min | Typ | Max | Unit | Test Conditions/Comments |
|---|--------------|-----|-----|-----|-------------|--|
| Undervoltage Lockout | UVLO | | | | | |
| Positive V_{DDx} Threshold | V_{DDxUV+} | | 1.6 | | V | |
| Negative V_{DDx} Threshold | V_{DDxUV-} | | 1.5 | | V | |
| V_{DDx} Hysteresis | V_{DDxUVH} | | 0.1 | | V | |
| AC SPECIFICATIONS | | | | | | |
| Output Rise/Fall Time | t_r/t_f | | 2.5 | | ns | 10% to 90% |
| Common-Mode Transient Immunity ⁷ | $ CM_H $ | 75 | 100 | | kV/ μ s | $V_{ix} = V_{DDx}$, $V_{CM} = 1000$ V, transient magnitude = 800 V |
| | $ CM_L $ | 75 | 100 | | kV/ μ s | $V_{ix} = 0$ V, $V_{CM} = 1000$ V, transient magnitude = 800 V |

¹ 150 Mbps is the highest data rate that can be guaranteed, although higher data rates are possible.

² I_{Ox} is the Channel x output current, where x = A, B, C, or D.

³ V_{IH} is the input side logic high.

⁴ V_{IL} is the input side logic low.

⁵ V_i is the voltage input.

⁶ E0 is the ADuM240E0/ADuM241E0/ADuM242E0 models, D0 is the ADuM240D0/ADuM241D0/ADuM242D0 models, E1 is the ADuM240E1/ADuM241E1/ADuM242E1 models, and D1 is the ADuM240D1/ADuM241D1/ADuM242D1 models. See the Ordering Guide section.

⁷ $|CM_H|$ is the maximum common-mode voltage slew rate that can be sustained while maintaining the voltage output (V_o) > 0.8 V_{DDx} . $|CM_L|$ is the maximum common-mode voltage slew rate that can be sustained while maintaining $V_o > 0.8$ V. The common-mode voltage slew rates apply to both rising and falling common-mode voltage edges.

Table 2. Total Supply Current vs. Data Throughput

| Parameter | Symbol | 1 Mbps | | | 25 Mbps | | | 100 Mbps | | | Unit |
|-----------------------|-----------|--------|-----|------|---------|-----|------|----------|------|------|------|
| | | Min | Typ | Max | Min | Typ | Max | Min | Typ | Max | |
| SUPPLY CURRENT | | | | | | | | | | | |
| ADuM240D/ADuM240E | | | | | | | | | | | |
| Supply Current Side 1 | I_{DD1} | | 6.8 | 10 | | 7.8 | 12 | | 11.8 | 17.4 | mA |
| Supply Current Side 2 | I_{DD2} | | 2.1 | 3.7 | | 3.9 | 5.7 | | 9.2 | 13 | mA |
| ADuM241D/ADuM241E | | | | | | | | | | | |
| Supply Current Side 1 | I_{DD1} | | 5.8 | 10.3 | | 7.0 | 10.9 | | 11.4 | 15.9 | mA |
| Supply Current Side 2 | I_{DD2} | | 4.0 | 6.85 | | 5.5 | 8.5 | | 10.3 | 14.0 | mA |
| ADuM242D/ADuM242E | | | | | | | | | | | |
| Supply Current Side 1 | I_{DD1} | | 4.3 | 7.7 | | 6.0 | 9.3 | | 10.3 | 14.2 | mA |
| Supply Current Side 2 | I_{DD2} | | 5.3 | 8.7 | | 6.7 | 10.1 | | 11.0 | 14.9 | mA |

ELECTRICAL CHARACTERISTICS—3.3 V OPERATION

All typical specifications are at $T_A = 25^\circ\text{C}$, $V_{DD1} = V_{DD2} = 3.3\text{ V}$. Minimum/maximum specifications apply over the entire recommended operation range: $3.0\text{ V} \leq V_{DD1} \leq 3.6\text{ V}$, $3.0\text{ V} \leq V_{DD2} \leq 3.6\text{ V}$, and $-40^\circ\text{C} \leq T_A \leq +125^\circ\text{C}$, unless otherwise noted. Switching specifications are tested with $C_L = 15\text{ pF}$ and CMOS signal levels, unless otherwise noted. Supply currents are specified with 50% duty cycle signals.

Table 3.

| Parameter | Symbol | Min | Typ | Max | Unit | Test Conditions/Comments |
|--|-----------------------|----------------------|-----------------|----------------------|---------------|--|
| SWITCHING SPECIFICATIONS | | | | | | |
| Pulse Width | PW | 6.6 | | | ns | Within PWD limit |
| Data Rate ¹ | | 150 | | | Mbps | Within PWD limit |
| Propagation Delay | t_{PHL} , t_{PLH} | 4.8 | 6.8 | 14 | ns | 50% input to 50% output |
| Pulse Width Distortion | PWD | | 0.7 | 3 | ns | $ t_{PLH} - t_{PHL} $ |
| Change vs. Temperature | | | 1.5 | | ps/°C | |
| Propagation Delay Skew | t_{PSK} | | | 7.5 | ns | Between any two units at the same temperature, voltage, and load |
| Channel Matching | | | | | | |
| Codirectional | t_{PSKCD} | | 0.7 | 3.0 | ns | |
| Opposing Direction | t_{PSKOD} | | 0.7 | 3.0 | ns | |
| Jitter | | | 580 | | ps p-p | See the Jitter Measurement section |
| | | | 120 | | ps rms | See the Jitter Measurement section |
| DC SPECIFICATIONS | | | | | | |
| Input Threshold Voltage | | | | | | |
| Logic High | V_{IH} | $0.7 \times V_{DDx}$ | | | V | |
| Logic Low | V_{IL} | | | $0.3 \times V_{DDx}$ | V | |
| Output Voltage | | | | | | |
| Logic High | V_{OH} | $V_{DDx} - 0.1$ | V_{DDx} | | V | $I_{Ox}^2 = -20\text{ }\mu\text{A}$, $V_{Ix} = V_{IxH}^3$ |
| | | $V_{DDx} - 0.4$ | $V_{DDx} - 0.2$ | | V | $I_{Ox}^2 = -2\text{ mA}$, $V_{Ix} = V_{IxH}^3$ |
| Logic Low | V_{OL} | | 0.0 | 0.1 | V | $I_{Ox}^2 = 20\text{ }\mu\text{A}$, $V_{Ix} = V_{IxL}^4$ |
| | | | 0.2 | 0.4 | V | $I_{Ox}^2 = 2\text{ mA}$, $V_{Ix} = V_{IxL}^4$ |
| Input Current per Channel | I_i | -10 | +0.01 | +10 | μA | $0\text{ V} \leq V_{Ix} \leq V_{DDx}$ |
| V_{E2} Enable Input Pull-Up Current | I_{PU} | -10 | -3 | | μA | $V_{E2} = 0\text{ V}$ |
| DISABLE ₁ Input Pull-Down Current | I_{PD} | | 9 | 15 | μA | DISABLE ₁ = V_{DDx} |
| Tristate Output Current per Channel | I_{OZ} | -10 | +0.01 | +10 | μA | $0\text{ V} \leq V_{Ox} \leq V_{DDx}$ |
| Quiescent Supply Current | | | | | | |
| ADuM240D/ADuM240E | | | | | | |
| | $I_{DD1(Q)}$ | | 1.2 | 2.12 | mA | $V_i^5 = 0$ (E0, D0), 1 (E1, D1) ⁶ |
| | $I_{DD2(Q)}$ | | 2.0 | 2.68 | mA | $V_i^5 = 0$ (E0, D0), 1 (E1, D1) ⁶ |
| | $I_{DD1(Q)}$ | | 12.0 | 19.6 | mA | $V_i^5 = 1$ (E0, D0), 0 (E1, D1) ⁶ |
| | $I_{DD2(Q)}$ | | 2.0 | 2.8 | mA | $V_i^5 = 1$ (E0, D0), 0 (E1, D1) ⁶ |
| ADuM241D/ADuM241E | | | | | | |
| | $I_{DD1(Q)}$ | | 1.5 | 2.36 | mA | $V_i^5 = 0$ (E0, D0), 1 (E1, D1) ⁶ |
| | $I_{DD2(Q)}$ | | 1.8 | 2.52 | mA | $V_i^5 = 0$ (E0, D0), 1 (E1, D1) ⁶ |
| | $I_{DD1(Q)}$ | | 9.8 | 16.7 | mA | $V_i^5 = 1$ (E0, D0), 0 (E1, D1) ⁶ |
| | $I_{DD2(Q)}$ | | 5.7 | 9.7 | mA | $V_i^5 = 1$ (E0, D0), 0 (E1, D1) ⁶ |
| ADuM242D/ADuM242E | | | | | | |
| | $I_{DD1(Q)}$ | | 1.6 | 2.4 | mA | $V_i^5 = 0$ (E0, D0), 1 (E1, D1) ⁶ |
| | $I_{DD2(Q)}$ | | 1.6 | 2.4 | mA | $V_i^5 = 0$ (E0, D0), 1 (E1, D1) ⁶ |
| | $I_{DD1(Q)}$ | | 7.0 | 11.2 | mA | $V_i^5 = 1$ (E0, D0), 0 (E1, D1) ⁶ |
| | $I_{DD2(Q)}$ | | 7.0 | 11.2 | mA | $V_i^5 = 1$ (E0, D0), 0 (E1, D1) ⁶ |
| Dynamic Supply Current | | | | | | |
| Dynamic Input | $I_{DDI(D)}$ | | 0.01 | | mA/Mbps | Inputs switching, 50% duty cycle |
| Dynamic Output | $I_{DDO(D)}$ | | 0.01 | | mA/Mbps | Inputs switching, 50% duty cycle |

| Parameter | Symbol | Min | Typ | Max | Unit | Test Conditions/Comments |
|---|--------------|-----|-----|-----|-------------|--|
| Undervoltage Lockout | UVLO | | | | | |
| Positive V_{DDx} Threshold | V_{DDxUV+} | | 1.6 | | V | |
| Negative V_{DDx} Threshold | V_{DDxUV-} | | 1.5 | | V | |
| V_{DDx} Hysteresis | V_{DDxUVH} | | 0.1 | | V | |
| AC SPECIFICATIONS | | | | | | |
| Output Rise/Fall Time | t_R/t_F | | 2.5 | | ns | 10% to 90% |
| Common-Mode Transient Immunity ⁷ | $ CM_H $ | 75 | 100 | | kV/ μ s | $V_{IX} = V_{DDx}$, $V_{CM} = 1000$ V, transient magnitude = 800 V |
| | $ CM_L $ | 75 | 100 | | kV/ μ s | $V_{IX} = 0$ V, $V_{CM} = 1000$ V, transient magnitude = 800 V |

¹ 150 Mbps is the highest data rate that can be guaranteed, although higher data rates are possible.

² I_{Ox} is the Channel x output current, where x = A, B, C, or D.

³ V_{IH} is the input side logic high.

⁴ V_{IL} is the input side logic low.

⁵ V_i is the voltage input.

⁶ E0 is the ADuM240E0/ADuM241E0/ADuM242E0 models, D0 is the ADuM240D0/ADuM241D0/ADuM242D0 models, E1 is the ADuM240E1/ADuM241E1/ADuM242E1 models, and D1 is the ADuM240D1/ADuM241D1/ADuM242D1 models. See the Ordering Guide section.

⁷ $|CM_H|$ is the maximum common-mode voltage slew rate that can be sustained while maintaining the voltage output (V_o) > 0.8 V_{DDx} . $|CM_L|$ is the maximum common-mode voltage slew rate that can be sustained while maintaining $V_o > 0.8$ V. The common-mode voltage slew rates apply to both rising and falling common-mode voltage edges.

Table 4. Total Supply Current vs. Data Throughput

| Parameter | Symbol | 1 Mbps | | | 25 Mbps | | | 100 Mbps | | | Unit |
|-----------------------|-----------|--------|------|------|---------|------|------|----------|------|------|------|
| | | Min | Typ | Max | Min | Typ | Max | Min | Typ | Max | |
| SUPPLY CURRENT | | | | | | | | | | | |
| ADuM240D/ADuM240E | | | | | | | | | | | |
| Supply Current Side 1 | I_{DD1} | | 6.6 | 9.8 | | 7.4 | 11.2 | | 10.7 | 15.9 | mA |
| Supply Current Side 2 | I_{DD2} | | 2.0 | 3.7 | | 3.5 | 5.5 | | 8.2 | 11.6 | mA |
| ADuM241D/ADuM241E | | | | | | | | | | | |
| Supply Current Side 1 | I_{DD1} | | 5.65 | 10.1 | | 6.65 | 10.5 | | 10.4 | 14.9 | mA |
| Supply Current Side 2 | I_{DD2} | | 3.9 | 6.65 | | 5.2 | 8.0 | | 9.4 | 12.8 | mA |
| ADuM242D/ADuM242E | | | | | | | | | | | |
| Supply Current Side 1 | I_{DD1} | | 4.3 | 7.7 | | 5.6 | 9.0 | | 9.1 | 13 | mA |
| Supply Current Side 2 | I_{DD2} | | 5.0 | 8.4 | | 6.2 | 9.6 | | 9.8 | 13.7 | mA |

ELECTRICAL CHARACTERISTICS—2.5 V OPERATION

All typical specifications are at $T_A = 25^\circ\text{C}$, $V_{DD1} = V_{DD2} = 2.5\text{ V}$. Minimum/maximum specifications apply over the entire recommended operation range: $2.25\text{ V} \leq V_{DD1} \leq 2.75\text{ V}$, $2.25\text{ V} \leq V_{DD2} \leq 2.75\text{ V}$, $-40^\circ\text{C} \leq T_A \leq +125^\circ\text{C}$, unless otherwise noted. Switching specifications are tested with $C_L = 15\text{ pF}$ and CMOS signal levels, unless otherwise noted. Supply currents are specified with 50% duty cycle signals.

Table 5.

| Parameter | Symbol | Min | Typ | Max | Unit | Test Conditions/Comments |
|--|-----------------------|----------------------|-----------------|----------------------|---------------|--|
| SWITCHING SPECIFICATIONS | | | | | | |
| Pulse Width | PW | 6.6 | | | ns | Within PWD limit |
| Data Rate ¹ | | 150 | | | Mbps | Within PWD limit |
| Propagation Delay | t_{PHL} , t_{PLH} | 5.0 | 7.0 | 14 | ns | 50% input to 50% output |
| Pulse Width Distortion | PWD | | 0.7 | 3 | ns | $ t_{PLH} - t_{PHL} $ |
| Change vs. Temperature | | | 1.5 | | ps/°C | |
| Propagation Delay Skew | t_{PSK} | | | 6.8 | ns | Between any two units at the same temperature, voltage, and load |
| Channel Matching | | | | | | |
| Codirectional | t_{PSKCD} | | 0.7 | 3.0 | ns | |
| Opposing Direction | t_{PSKOD} | | 0.7 | 3.0 | ns | |
| Jitter | | | 800 | | ps p-p | See the Jitter Measurement section |
| | | | 190 | | ps rms | See the Jitter Measurement section |
| DC SPECIFICATIONS | | | | | | |
| Input Threshold Voltage | | | | | | |
| Logic High | V_{IH} | $0.7 \times V_{DDx}$ | | | V | |
| Logic Low | V_{IL} | | | $0.3 \times V_{DDx}$ | V | |
| Output Voltage | | | | | | |
| Logic High | V_{OH} | $V_{DDx} - 0.1$ | V_{DDx} | | V | $I_{Ox}^2 = -20\ \mu\text{A}$, $V_{Ix} = V_{IxH}^3$ |
| | | $V_{DDx} - 0.4$ | $V_{DDx} - 0.2$ | | V | $I_{Ox}^2 = -2\ \text{mA}$, $V_{Ix} = V_{IxH}^3$ |
| Logic Low | V_{OL} | | 0.0 | 0.1 | V | $I_{Ox}^2 = 20\ \mu\text{A}$, $V_{Ix} = V_{IxL}^4$ |
| | | | 0.2 | 0.4 | V | $I_{Ox}^2 = 2\ \text{mA}$, $V_{Ix} = V_{IxL}^4$ |
| Input Current per Channel | I_I | -10 | +0.01 | +10 | μA | $0\text{ V} \leq V_{Ix} \leq V_{DDx}$ |
| V_{E2} Enable Input Pull-Up Current | I_{PU} | -10 | -3 | | μA | $V_{E2} = 0\text{ V}$ |
| DISABLE ₁ Input Pull-Down Current | I_{PD} | | 9 | 15 | μA | DISABLE ₁ = V_{DDx} |
| Tristate Output Current per Channel | I_{OZ} | -10 | +0.01 | +10 | μA | $0\text{ V} \leq V_{Ox} \leq V_{DDx}$ |
| Quiescent Supply Current | | | | | | |
| ADuM240D/ADuM240E | | | | | | |
| | $I_{DD1(Q)}$ | | 1.2 | 2.0 | mA | $V^5 = 0$ (E0, D0), 1 (E1, D1) ⁶ |
| | $I_{DD2(Q)}$ | | 2.0 | 2.64 | mA | $V^5 = 0$ (E0, D0), 1 (E1, D1) ⁶ |
| | $I_{DD1(Q)}$ | | 1.2 | 19.6 | mA | $V^5 = 1$ (E0, D0), 0 (E1, D1) ⁶ |
| | $I_{DD2(Q)}$ | | 2.0 | 2.76 | mA | $V^5 = 1$ (E0, D0), 0 (E1, D1) ⁶ |
| ADuM241D/ADuM241E | | | | | | |
| | $I_{DD1(Q)}$ | | 1.46 | 2.32 | mA | $V^5 = 0$ (E0, D0), 1 (E1, D1) ⁶ |
| | $I_{DD2(Q)}$ | | 1.75 | 2.47 | mA | $V^5 = 0$ (E0, D0), 1 (E1, D1) ⁶ |
| | $I_{DD1(Q)}$ | | 9.7 | 16.6 | mA | $V^5 = 1$ (E0, D0), 0 (E1, D1) ⁶ |
| | $I_{DD2(Q)}$ | | 5.67 | 9.67 | mA | $V^5 = 1$ (E0, D0), 0 (E1, D1) ⁶ |
| ADuM242D/ADuM242E | | | | | | |
| | $I_{DD1(Q)}$ | | 1.6 | 2.32 | mA | $V^5 = 0$ (E0, D0), 1 (E1, D1) ⁶ |
| | $I_{DD2(Q)}$ | | 1.6 | 2.32 | mA | $V^5 = 0$ (E0, D0), 1 (E1, D1) ⁶ |
| | $I_{DD1(Q)}$ | | 7.0 | 11.2 | mA | $V^5 = 1$ (E0, D0), 0 (E1, D1) ⁶ |
| | $I_{DD2(Q)}$ | | 7.0 | 11.2 | mA | $V^5 = 1$ (E0, D0), 0 (E1, D1) ⁶ |
| Dynamic Supply Current | | | | | | |
| Dynamic Input | $I_{DDI(D)}$ | | 0.01 | | mA/Mbps | Inputs switching, 50% duty cycle |
| Dynamic Output | $I_{DDO(D)}$ | | 0.01 | | mA/Mbps | Inputs switching, 50% duty cycle |

| Parameter | Symbol | Min | Typ | Max | Unit | Test Conditions/Comments |
|---|--------------|-----|-----|-----|-------------|--|
| Undervoltage Lockout | | | | | | |
| Positive V_{DDx} Threshold | V_{DDxUV+} | | 1.6 | | V | |
| Negative V_{DDx} Threshold | V_{DDxUV-} | | 1.5 | | V | |
| V_{DDx} Hysteresis | V_{DDxUVH} | | 0.1 | | V | |
| AC SPECIFICATIONS | | | | | | |
| Output Rise/Fall Time | t_R/t_F | | 2.5 | | ns | 10% to 90% |
| Common-Mode Transient Immunity ⁷ | $ CM_H $ | 75 | 100 | | kV/ μ s | $V_{IX} = V_{DDx}$, $V_{CM} = 1000$ V, transient magnitude = 800 V |
| | $ CM_L $ | 75 | 100 | | kV/ μ s | $V_{IX} = 0$ V, $V_{CM} = 1000$ V, transient magnitude = 800 V |

¹ 150 Mbps is the highest data rate that can be guaranteed, although higher data rates are possible.

² I_{Ox} is the Channel x output current, where x = A, B, C, or D.

³ V_{IH} is the input side logic high.

⁴ V_{IL} is the input side logic low.

⁵ V_i is the voltage input.

⁶ E0 is the ADuM240E0/ADuM241E0/ADuM242E0 models, D0 is the ADuM240D0/ADuM241D0/ADuM242D0 models, E1 is the ADuM240E1/ADuM241E1/ADuM242E1 models, and D1 is the ADuM240D1/ADuM241D1/ADuM242D1 models. See the Ordering Guide section.

⁷ $|CM_H|$ is the maximum common-mode voltage slew rate that can be sustained while maintaining the voltage output (V_o) > 0.8 V_{DDx} . $|CM_L|$ is the maximum common-mode voltage slew rate that can be sustained while maintaining V_o > 0.8 V. The common-mode voltage slew rates apply to both rising and falling common-mode voltage edges.

Table 6. Total Supply Current vs. Data Throughput

| Parameter | Symbol | 1 Mbps | | | 25 Mbps | | | 100 Mbps | | | Unit |
|-----------------------|-----------|--------|-----|------|---------|-----|------|----------|------|------|------|
| | | Min | Typ | Max | Min | Typ | Max | Min | Typ | Max | |
| SUPPLY CURRENT | | | | | | | | | | | |
| ADuM240D/ADuM240E | | | | | | | | | | | |
| Supply Current Side 1 | I_{DD1} | | 6.5 | 9.8 | | 7.3 | 11.1 | | 10.4 | 15.5 | mA |
| Supply Current Side 2 | I_{DD2} | | 2.0 | 3.6 | | 3.3 | 5.2 | | 7.3 | 10.2 | mA |
| ADuM241D/ADuM241E | | | | | | | | | | | |
| Supply Current Side 1 | I_{DD1} | | 5.6 | 10.0 | | 6.4 | 10.4 | | 9.7 | 14.5 | mA |
| Supply Current Side 2 | I_{DD2} | | 3.8 | 6.55 | | 4.8 | 7.7 | | 8.3 | 11.5 | mA |
| ADuM242D/ADuM242E | | | | | | | | | | | |
| Supply Current Side 1 | I_{DD1} | | 4.3 | 7.7 | | 5.4 | 8.8 | | 8.8 | 12.7 | mA |
| Supply Current Side 2 | I_{DD2} | | 5.0 | 8.4 | | 6.1 | 9.5 | | 9.5 | 13.4 | mA |

ELECTRICAL CHARACTERISTICS—1.8 V OPERATION

All typical specifications are at $T_A = 25^\circ\text{C}$, $V_{DD1} = V_{DD2} = 1.8\text{ V}$. Minimum/maximum specifications apply over the entire recommended operation range: $1.7\text{ V} \leq V_{DD1} \leq 1.9\text{ V}$, $1.7\text{ V} \leq V_{DD2} \leq 1.9\text{ V}$, and $-40^\circ\text{C} \leq T_A \leq +125^\circ\text{C}$, unless otherwise noted. Switching specifications are tested with $C_L = 15\text{ pF}$ and CMOS signal levels, unless otherwise noted. Supply currents are specified with 50% duty cycle signals.

Table 7.

| Parameter | Symbol | Min | Typ | Max | Unit | Test Conditions/Comments |
|--|-----------------------|----------------------|-----------------|----------------------|---------------|--|
| SWITCHING SPECIFICATIONS | | | | | | |
| Pulse Width | PW | 6.6 | | | ns | Within PWD limit |
| Data Rate ¹ | | 150 | | | Mbps | Within PWD limit |
| Propagation Delay | t_{PHL} , t_{PLH} | 5.8 | 8.7 | 15 | ns | 50% input to 50% output |
| Pulse Width Distortion | PWD | | 0.7 | 3 | ns | $ t_{PLH} - t_{PHL} $ |
| Change vs. Temperature | | | 1.5 | | ps/°C | |
| Propagation Delay Skew | t_{PSK} | | | 7.0 | ns | Between any two units at the same temperature, voltage, and load |
| Channel Matching | | | | | | |
| Codirectional | t_{PSKCD} | | 0.7 | 3.0 | ns | |
| Opposing Direction | t_{PSKOD} | | 0.7 | 3.0 | ns | |
| Jitter | | | 470 | | ps p-p | See the Jitter Measurement section |
| | | | 70 | | ps rms | See the Jitter Measurement section |
| DC SPECIFICATIONS | | | | | | |
| Input Threshold Voltage | | | | | | |
| Logic High | V_{IH} | $0.7 \times V_{DDx}$ | | | V | |
| Logic Low | V_{IL} | | | $0.3 \times V_{DDx}$ | V | |
| Output Voltage | | | | | | |
| Logic High | V_{OH} | $V_{DDx} - 0.1$ | V_{DDx} | | V | $I_{Ox}^2 = -20\ \mu\text{A}$, $V_{Ix} = V_{IxH}^3$ |
| | | $V_{DDx} - 0.4$ | $V_{DDx} - 0.2$ | | V | $I_{Ox}^2 = -2\ \text{mA}$, $V_{Ix} = V_{IxH}^3$ |
| Logic Low | V_{OL} | | 0.0 | 0.1 | V | $I_{Ox}^2 = 20\ \mu\text{A}$, $V_{Ix} = V_{IxL}^4$ |
| | | | 0.2 | 0.4 | V | $I_{Ox}^2 = 2\ \text{mA}$, $V_{Ix} = V_{IxL}^4$ |
| Input Current per Channel | I_I | -10 | +0.01 | +10 | μA | $0\text{ V} \leq V_{Ix} \leq V_{DDx}$ |
| V_{E2} Enable Input Pull-Up Current | I_{PU} | -10 | -3 | | μA | $V_{E2} = 0\text{ V}$ |
| DISABLE ₁ Input Pull-Down Current | I_{PD} | | 9 | 15 | μA | DISABLE ₁ = V_{DDx} |
| Tristate Output Current per Channel | I_{OZ} | -10 | +0.01 | +10 | μA | $0\text{ V} \leq V_{Ox} \leq V_{DDx}$ |
| Quiescent Supply Current | | | | | | |
| ADuM240D/ADuM240E | | | | | | |
| | $I_{DD1(Q)}$ | | 1.2 | 1.92 | mA | $V_I^5 = 0$ (E0, D0), 1 (E1, D1) ⁶ |
| | $I_{DD2(Q)}$ | | 2.0 | 2.64 | mA | $V_I^5 = 0$ (E0, D0), 1 (E1, D1) ⁶ |
| | $I_{DD1(Q)}$ | | 12.0 | 19.6 | mA | $V_I^5 = 1$ (E0, D0), 0 (E1, D1) ⁶ |
| | $I_{DD2(Q)}$ | | 2.0 | 2.76 | mA | $V_I^5 = 1$ (E0, D0), 0 (E1, D1) ⁶ |
| ADuM241D/ADuM241E | | | | | | |
| | $I_{DD1(Q)}$ | | 1.4 | 2.28 | mA | $V_I^5 = 0$ (E0, D0), 1 (E1, D1) ⁶ |
| | $I_{DD2(Q)}$ | | 1.73 | 2.45 | mA | $V_I^5 = 0$ (E0, D0), 1 (E1, D1) ⁶ |
| | $I_{DD1(Q)}$ | | 9.6 | 16.5 | mA | $V_I^5 = 1$ (E0, D0), 0 (E1, D1) ⁶ |
| | $I_{DD2(Q)}$ | | 5.6 | 9.6 | mA | $V_I^5 = 1$ (E0, D0), 0 (E1, D1) ⁶ |
| ADuM242D/ADuM242E | | | | | | |
| | $I_{DD1(Q)}$ | | 1.6 | 2.28 | mA | $V_I^5 = 0$ (E0, D0), 1 (E1, D1) ⁶ |
| | $I_{DD2(Q)}$ | | 1.6 | 2.28 | mA | $V_I^5 = 0$ (E0, D0), 1 (E1, D1) ⁶ |
| | $I_{DD1(Q)}$ | | 7.0 | 11.2 | mA | $V_I^5 = 1$ (E0, D0), 0 (E1, D1) ⁶ |
| | $I_{DD2(Q)}$ | | 7.0 | 11.2 | mA | $V_I^5 = 1$ (E0, D0), 0 (E1, D1) ⁶ |
| Dynamic Supply Current | | | | | | |
| Dynamic Input | $I_{DDI(D)}$ | | 0.01 | | mA/Mbps | Inputs switching, 50% duty cycle |
| Dynamic Output | $I_{DDO(D)}$ | | 0.01 | | mA/Mbps | Inputs switching, 50% duty cycle |

| Parameter | Symbol | Min | Typ | Max | Unit | Test Conditions/Comments |
|---|--------------|-----|-----|-----|-------------|--|
| Undervoltage Lockout | UVLO | | | | | |
| Positive V_{DDx} Threshold | V_{DDxUV+} | | 1.6 | | V | |
| Negative V_{DDx} Threshold | V_{DDxUV-} | | 1.5 | | V | |
| V_{DDx} Hysteresis | V_{DDxUVH} | | 0.1 | | V | |
| AC SPECIFICATIONS | | | | | | |
| Output Rise/Fall Time | t_R/t_F | | 2.5 | | ns | 10% to 90% |
| Common-Mode Transient Immunity ⁷ | $ CM_H $ | 75 | 100 | | kV/ μ s | $V_{IX} = V_{DDx}$, $V_{CM} = 1000$ V, transient magnitude = 800 V |
| | $ CM_L $ | 75 | 100 | | kV/ μ s | $V_{IX} = 0$ V, $V_{CM} = 1000$ V, transient magnitude = 800 V |

¹ 150 Mbps is the highest data rate that can be guaranteed, although higher data rates are possible.

² I_{Ox} is the Channel x output current, where x = A, B, C, or D.

³ V_{IH} is the input side logic high.

⁴ V_{IL} is the input side logic low.

⁵ V_i is the voltage input.

⁶ E0 is the ADuM240E0/ADuM241E0/ADuM242E0 models, D0 is the ADuM240D0/ADuM241D0/ADuM242D0 models, E1 is the ADuM240E1/ADuM241E1/ADuM242E1 models, and D1 is the ADuM240D1/ADuM241D1/ADuM242D1 models. See the Ordering Guide section.

⁷ $|CM_H|$ is the maximum common-mode voltage slew rate that can be sustained while maintaining the voltage output (V_o) > 0.8 V_{DDx} . $|CM_L|$ is the maximum common-mode voltage slew rate that can be sustained while maintaining $V_o > 0.8$ V. The common-mode voltage slew rates apply to both rising and falling common-mode voltage edges.

Table 8. Total Supply Current vs. Data Throughput

| Parameter | Symbol | 1 Mbps | | | 25 Mbps | | | 100 Mbps | | | Unit |
|-----------------------|-----------|--------|------|------|---------|-----|------|----------|------|------|------|
| | | Min | Typ | Max | Min | Typ | Max | Min | Typ | Max | |
| SUPPLY CURRENT | | | | | | | | | | | |
| ADuM240D/ADuM240E | | | | | | | | | | | |
| Supply Current Side 1 | I_{DD1} | | 6.4 | 9.8 | | 7.2 | 11 | | 10.2 | 15.2 | mA |
| Supply Current Side 2 | I_{DD2} | | 1.9 | 3.5 | | 3.1 | 5.0 | | 6.8 | 10 | mA |
| ADuM241D/ADuM240E | | | | | | | | | | | |
| Supply Current Side 1 | I_{DD1} | | 5.5 | 9.1 | | 6.3 | 10.0 | | 9.6 | 14.0 | mA |
| Supply Current Side 2 | I_{DD2} | | 3.72 | 6.45 | | 4.8 | 7.5 | | 8.4 | 11.2 | mA |
| ADuM242D/ADuM242E | | | | | | | | | | | |
| Supply Current Side 1 | I_{DD1} | | 4.3 | 7.7 | | 5.3 | 8.7 | | 8.6 | 12.6 | mA |
| Supply Current Side 2 | I_{DD2} | | 4.9 | 8.3 | | 6.0 | 9.4 | | 9.3 | 13.3 | mA |

INSULATION AND SAFETY RELATED SPECIFICATIONS

For additional information, see www.analog.com/icouplersafety.

Table 9. RW-16 Wide Body [SOIC_W] Package

| Parameter | Symbol | Value | Unit | Test Conditions/Comments |
|---|---------|-------|--------|--|
| Rated Dielectric Insulation Voltage | | 5000 | V rms | 1-minute duration |
| Minimum External Air Gap (Clearance) | L (I01) | 7.8 | mm min | Measured from input terminals to output terminals, shortest distance through air |
| Minimum External Tracking (Creepage) | L (I02) | 7.8 | mm min | Measured from input terminals to output terminals, shortest distance path along body |
| Minimum Clearance in the Plane of the Printed Circuit Board (PCB Clearance) | L (PCB) | 8.1 | mm min | Measured from input terminals to output terminals, shortest distance through air, line of sight, in the PCB mounting plane |
| Minimum Internal Gap (Internal Clearance) | | 25.5 | µm min | Insulation distance through insulation |
| Tracking Resistance (Comparative Tracking Index) | CTI | >400 | V | DIN IEC 112/VDE 0303 Part 1 |
| Material Group | | II | | Material Group (DIN VDE 0110, 1/89, Table 1) |

Table 10. RI-16 -2 Wide Body Increased Creepage [SOIC_IC] Package

| Parameter | Symbol | Value | Unit | Test Conditions/Comments |
|---|---------|-------|--------|--|
| Rated Dielectric Insulation Voltage | | 5000 | V rms | 1-minute duration |
| Minimum External Air Gap (Clearance) | L (I01) | 8.3 | mm min | Measured from input terminals to output terminals, shortest distance through air |
| Minimum External Tracking (Creepage) | L (I02) | 8.3 | mm min | Measured from input terminals to output terminals, shortest distance path along body |
| Minimum Clearance in the Plane of the Printed Circuit Board (PCB Clearance) | L (PCB) | 8.3 | mm min | Measured from input terminals to output terminals, shortest distance through air, line of sight, in the PCB mounting plane |
| Minimum Internal Gap (Internal Clearance) | | 25.5 | µm min | Insulation distance through insulation |
| Tracking Resistance (Comparative Tracking Index) | CTI | >400 | V | DIN IEC 112/VDE 0303 Part 1 |
| Material Group | | II | | Material Group (DIN VDE 0110, 1/89, Table 1) |

PACKAGE CHARACTERISTICS**Table 11.**

| Parameter | Symbol | Min | Typ | Max | Unit | Test Conditions/Comments |
|--|------------------|-----|------------------|-----|------|---|
| Resistance (Input to Output) ¹ | R _{I-O} | | 10 ¹³ | | Ω | |
| Capacitance (Input to Output) ¹ | C _{I-O} | | 2.2 | | pF | f = 1 MHz |
| Input Capacitance ² | C _I | | 4.0 | | pF | |
| IC Junction to Ambient Thermal Resistance | θ _{JA} | | 45 | | °C/W | Thermocouple located at center of package underside |

¹ The device is considered a 2-terminal device: Pin 1 through Pin 8 are shorted together, and Pin 9 through Pin 16 are shorted together.

² Input capacitance is from any input data pin to ground.

REGULATORY INFORMATION

See Table 17, Table 18, and the Insulation Lifetime section for details regarding recommended maximum working voltages for specific cross-isolation waveforms and insulation levels.

Table 12. RW-16 Wide Body [SOIC_W] Package

| UL | CSA | VDE | CQC |
|---|--|---|--|
| Recognized Under UL 1577 Component Recognition Program ¹ | Approved under CSA Component Acceptance Notice 5A | Certified according to DIN V VDE V 0884-10 (VDE V 0884-10):2006-12 ² | Certified by CQC11-471543-2012, GB4943.1-2011: |
| Single Protection, 5000 V rms Isolation Voltage | CSA 60950-1-07+A1+A2 and IEC 60950-1, second edition, +A1+A2: | Reinforced insulation, $V_{IORM} = 849$ peak, $V_{IOSM} = 8000$ V peak | Basic insulation at 760 V rms (1075 V peak) |
| Double Protection, 5000 V rms Isolation Voltage | Basic insulation at 780 V rms (1103 V peak) | Basic insulation, $V_{IORM} = 849$ V peak, $V_{IOSM} = 12$ kV peak | Reinforced insulation at 380 V rms (537 V peak), tropical climate, altitude ≤ 5000 meters |
| File E214100 | Reinforced insulation at 390 V rms (552 V peak) IEC 60601-1 Edition 3.1: Basic insulation (1 means of patient protection (1 MOPP)), 490 V rms (686 V peak) Reinforced insulation (2 MOPP), 238 V rms (325 V peak) CSA 61010-1-12 and IEC 61010-1 third edition: Basic insulation at 300 V rms mains, 780 V secondary (1103 V peak) Reinforced insulation at 300 V rms mains, 390 V secondary (552 V peak) File 205078 | File 2471900-4880-0001 | File CQC16001147385 |

¹ In accordance with UL 1577, each product is proof tested by applying an insulation test voltage ≥ 6000 V rms for 1 sec.

² In accordance with DIN V VDE V 0884-10, each product is proof tested by applying an insulation test voltage ≥ 1592 V peak for 1 sec (partial discharge detection limit = 5 pC). The asterisk (*) branded on the component designates DIN V VDE V 0884-10 approval.

Table 13. RI-16 -2 Wide Body Increased Creepage [SOIC_IC] Package

| UL | CSA | VDE | CQC |
|--|--|---|--|
| Recognized Under 1577 Component Recognition Program ¹ | Approved under CSA Component Acceptance Notice 5A | Certified according to DIN V VDE V 0884-10 (VDE V 0884-10):2006-12 ² | Certified by CQC11-471543-2012, GB4943.1-2011 |
| Single Protection, 5000 V rms Isolation Voltage | CSA 60950-1-07+A1+A2 and IEC 60950-1, second edition, +A1+A2: | Reinforced insulation, $V_{IORM} = 849$ peak, $V_{IOSM} = 8000$ V peak | Basic insulation at 820 V rms (1159 V peak) |
| Double Protection, 5000 V rms Isolation Voltage | Basic insulation at 830 V rms (1174 V peak) | Basic insulation, $V_{IORM} = 849$ V peak, $V_{IOSM} = 12$ kV peak | Reinforced insulation at 410 V rms (578 V peak), tropical climate, altitude ≤ 5000 meters |
| File E214100 | Reinforced insulation at 415 V rms (587 V peak) IEC 60601-1 Edition 3.1: Basic insulation (1 means of patient protection (1 MOPP)), 519 V rms (734 V peak) Reinforced insulation (2 MOPP), 261 V rms (369 V peak) CSA 61010-1-12 and IEC 61010-1 third edition: Basic insulation at 300 V rms mains, 830 V secondary (1174 V peak) Reinforced insulation at 300 V rms Mains, 390 V secondary (587 V peak) File 205078 | File 2471900-4880-0001 | File CQC17001171586 |

¹ In accordance with UL 1577, each product is proof tested by applying an insulation test voltage ≥ 6000 V rms for 1 sec.

² In accordance with DIN V VDE V 0884-10, each product is proof tested by applying an insulation test voltage ≥ 1592 V peak for 1 sec (partial discharge detection limit = 5 pC). The asterisk (*) branded on the component designates DIN V VDE V 0884-10 approval.

DIN V VDE V 0884-10 (VDE V 0884-10) INSULATION CHARACTERISTICS

These isolators are suitable for reinforced electrical isolation only within the safety limit data. Protective circuits ensure the maintenance of the safety data. The asterisk (*) marking on packages denotes DIN V VDE V 0884-10 approval.

Table 14.

| Description | Test Conditions/Comments | Symbol | Characteristic | Unit |
|---|--|-------------|--------------------------------|--------|
| Installation Classification per DIN VDE 0110 For Rated Mains Voltage ≤ 150 V rms For Rated Mains Voltage ≤ 300 V rms For Rated Mains Voltage ≤ 600 V rms | | | I to IV I to IV I to III | |
| Climatic Classification | | | 40/125/21 | |
| Pollution Degree per DIN VDE 0110, Table 1 | | | 2 | |
| Maximum Working Insulation Voltage | | V_{IORM} | 849 | V peak |
| Input to Output Test Voltage, Method B1 | $V_{IORM} \times 1.875 = V_{pd(m)}$, 100% production test, $t_{ini} = t_m = 1$ sec, partial discharge < 5 pC | $V_{pd(m)}$ | 1592 | V peak |
| Input to Output Test Voltage, Method A After Environmental Tests Subgroup 1 | $V_{IORM} \times 1.5 = V_{pd(m)}$, $t_{ini} = 60$ sec, $t_m = 10$ sec, partial discharge < 5 pC | $V_{pd(m)}$ | 1274 | V peak |
| After Input and/or Safety Test Subgroup 2 and Subgroup 3 | $V_{IORM} \times 1.2 = V_{pd(m)}$, $t_{ini} = 60$ sec, $t_m = 10$ sec, partial discharge < 5 pC | | 1019 | V peak |
| Highest Allowable Overvoltage | | V_{IOTM} | 7000 | V peak |
| Surge Isolation Voltage Basic | $V_{PEAK} = 12.8$ kV, 1.2 μ s rise time, 50 μ s, 50% fall time | V_{IOSM} | 12000 | V peak |
| Surge Isolation Voltage Reinforced | $V_{PEAK} = 12.8$ kV, 1.2 μ s rise time, 50 μ s, 50% fall time | V_{IOSM} | 8000 | V peak |
| Safety Limiting Values | Maximum value allowed in the event of a failure (see Figure 4) | | | |
| Maximum Junction Temperature | | T_S | 150 | °C |
| Total Power Dissipation at 25°C | | P_S | 2.78 | W |
| Insulation Resistance at T_S | $V_{IO} = 500$ V | R_S | >10 ⁹ | Ω |

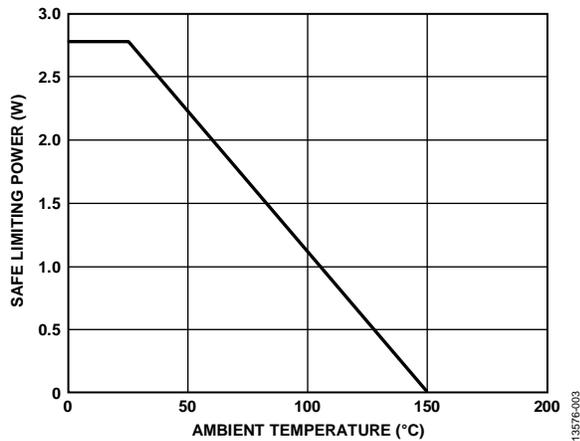

Figure 4. Thermal Derating Curve, Dependence of Safety Limiting Values with Ambient Temperature per DIN V VDE V 0884-10

RECOMMENDED OPERATING CONDITIONS

Table 15.

| Parameter | Symbol | Rating |
|----------------------------------|--------------------|-----------------|
| Operating Temperature | T_A | -40°C to +125°C |
| Supply Voltages | V_{DD1}, V_{DD2} | 1.7 V to 5.5 V |
| Input Signal Rise and Fall Times | | 1.0 ms |

ABSOLUTE MAXIMUM RATINGS

T_A = 25°C, unless otherwise noted.

Table 16.

| Parameter | Rating |
|--|------------------------------------|
| Storage Temperature (T _{ST}) Range | −65°C to +150°C |
| Ambient Operating Temperature (T _A) Range | −40°C to +125°C |
| Supply Voltages (V _{DD1} , V _{DD2}) | −0.5 V to +7.0 V |
| Input Voltages (V _{IA} , V _{IB} , V _{IC} , V _{ID} , V _{E1} , V _{E2} , DISABLE ₁ , DISABLE ₂) ¹ | −0.5 V to V _{DD1} + 0.5 V |
| Output Voltages (V _{OA} , V _{OB} , V _{OC} , V _{OD}) ² | −0.5 V to V _{DD0} + 0.5 V |
| Average Output Current per Pin ³ | |
| Side 1 Output Current (I _{O1}) | −10 mA to +10 mA |
| Side 2 Output Current (I _{O2}) | −10 mA to +10 mA |
| Common-Mode Transients ⁴ | −150 kV/μs to +150 kV/μs |

¹ V_{DD1} is the input side supply voltage.

² V_{DD0} is the output side supply voltage.

³ See Figure 4 for the maximum rated current values for various ambient temperatures.

⁴ Refers to the common-mode transients across the insulation barrier. Common-mode transients exceeding the absolute maximum ratings may cause latch-up or permanent damage.

Stresses at or above those listed under Absolute Maximum Ratings may cause permanent damage to the product. This is a stress rating only; functional operation of the product at these or any other conditions above those indicated in the operational section of this specification is not implied. Operation beyond the maximum operating conditions for extended periods may affect product reliability.

Table 17. Maximum Continuous Working Voltage¹ RW-16 Wide Body [SOIC_W] Package

| Parameter | Rating | Constraint |
|-----------------------|-------------|---|
| AC Voltage | | |
| Bipolar Waveform | | |
| Basic Insulation | 849 V peak | 50-year minimum insulation lifetime |
| Reinforced Insulation | 768 V peak | Lifetime limited by package creepage maximum approved working voltage per IEC 60950-1 |
| Unipolar Waveform | | |
| Basic Insulation | 1698 V peak | 50-year minimum insulation lifetime |
| Reinforced Insulation | 885 V peak | Lifetime limited by package creepage maximum approved working voltage per IEC 60950-1 |
| DC Voltage | | |
| Basic Insulation | 1092 V peak | Lifetime limited by package creepage maximum approved working voltage per IEC 60950-1 |
| Reinforced Insulation | 543 V peak | Lifetime limited by package creepage maximum approved working voltage per IEC 60950-1 |

¹ Refers to the continuous voltage magnitude imposed across the isolation barrier. See the Insulation Lifetime section for more details.

Table 18. Maximum Continuous Working Voltage¹ RI-16-2 Wide Body Increased Creepage [SOIC_IC] Package

| Parameter | Rating | Constraint |
|-----------------------|-------------|---|
| AC Voltage | | |
| Bipolar Waveform | | |
| Basic Insulation | 849 V peak | 50-year minimum insulation lifetime |
| Reinforced Insulation | 819 V peak | Lifetime limited by package creepage maximum approved working voltage per IEC 60950-1 |
| Unipolar Waveform | | |
| Basic Insulation | 1698 V peak | 50-year minimum insulation lifetime |
| Reinforced Insulation | 943 V peak | Lifetime limited by package creepage maximum approved working voltage per IEC 60950-1 |
| DC Voltage | | |
| Basic Insulation | 1157 V peak | Lifetime limited by package creepage maximum approved working voltage per IEC 60950-1 |
| Reinforced Insulation | 579 V peak | Lifetime limited by package creepage maximum approved working voltage per IEC 60950-1 |

¹ Refers to the continuous voltage magnitude imposed across the isolation barrier. See the Insulation Lifetime section for more details.

ESD CAUTION



ESD (electrostatic discharge) sensitive device. Charged devices and circuit boards can discharge without detection. Although this product features patented or proprietary protection circuitry, damage may occur on devices subjected to high energy ESD. Therefore, proper ESD precautions should be taken to avoid performance degradation or loss of functionality.

Truth Tables

Table 19. ADuM240D/ADuM241D/ADuM242D Truth Table (Positive Logic)

| V _{ix} Input ^{1,2} | V _{DISABLEx} Input ^{1,2} | V _{DDI} State ² | V _{DDO} State ² | Default Low (D0), V _{Ox} Output ^{1,2,3} | Default High (D1), V _{Ox} Output ^{1,2,3} | Test Conditions/ Comments |
|--------------------------------------|--|-------------------------------------|-------------------------------------|--|---|--------------------------------------|
| L | L or NC | Powered | Powered | L | L | Normal operation |
| H | L or NC | Powered | Powered | H | H | Normal operation |
| X | H | Powered | Powered | L | H | Inputs disabled, fail-safe output |
| X ⁴ | X ⁴ | Unpowered | Powered | L | H | Fail-safe output |
| X ⁴ | X ⁴ | Powered | Unpowered | Indeterminate | Indeterminate | |

¹ L means low, H means high, X means don't care, and NC means not connected.

² V_{ix} and V_{Ox} refer to the input and output signals of a given channel (A, B, C, or D). V_{DISABLEx} refers to the input disable signal on the same side as the V_{ix} inputs. V_{DDI} and V_{DDO} refer to the supply voltages on the input and output sides of the given channel, respectively.

³ D0 is the ADuM240D0/ADuM241D0/ADuM242D0 models, and D1 is the ADuM240D1/ADuM241D1/ADuM242D1 models. See the Ordering Guide section.

⁴ Input pins (V_{ix}, V_{DISABLEx}) on the same side as an unpowered supply must be in a low state to avoid powering the device through its ESD protection circuitry.

Table 20. ADuM240E/ADuM241E/ADuM242E Truth Table (Positive Logic)

| V _{ix} Input ^{1,2} | V _{Ex} Input ^{1,2} | V _{DDI} State ² | V _{DDO} State ² | Default Low (E0), V _{Ox} Output ^{1,2,3} | Default High (E1), V _{Ox} Output ^{1,2,3} | Test Conditions/ Comments |
|--------------------------------------|--------------------------------------|-------------------------------------|-------------------------------------|--|---|------------------------------|
| L | H or NC | Powered | Powered | L | L | Normal operation |
| H | H or NC | Powered | Powered | H | H | Normal operation |
| X | L | Powered | Powered | Z | Z | Outputs disabled |
| L | H or NC | Unpowered | Powered | L | H | Fail-safe output |
| X ⁴ | L ⁴ | Unpowered | Powered | Z | Z | Outputs disabled |
| X ⁴ | X ⁴ | Powered | Unpowered | Indeterminate | Indeterminate | |

¹ L means low, H means high, X means don't care, NC means not connected, and Z means high impedance.

² V_{ix} and V_{Ox} refer to the input and output signals of a given channel (A, B, C, or D). V_{Ex} refers to the output enable signal on the same side as the V_{Ox} outputs. V_{DDI} and V_{DDO} refer to the supply voltages on the input and output sides of the given channel, respectively.

³ E0 is the ADuM240E0/ADuM241E0/ADuM242E0 models, and E1 is the ADuM240E1/ADuM241E1/ADuM242E1 models. See the Ordering Guide section.

⁴ Input pins (V_{ix}, V_{Ex}) on the same side as an unpowered supply must be in a low state to avoid powering the device through its ESD protection circuitry.

PIN CONFIGURATIONS AND FUNCTION DESCRIPTIONS

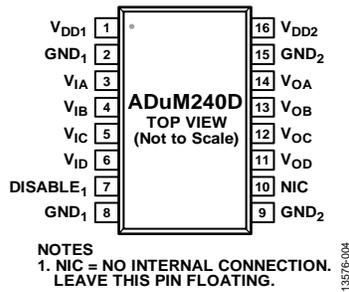

Figure 5. ADuM240D Pin Configuration

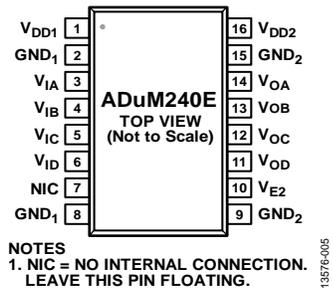

Figure 6. ADuM240E Pin Configuration

Table 21. Pin Function Descriptions

| Pin No. ¹ | | Mnemonic | Description |
|----------------------|----------------|----------------------|---|
| ADuM240D | ADuM240E | | |
| 1 | 1 | V _{DD1} | Supply Voltage for Isolator Side 1. |
| 2, 8 | 2, 8 | GND ₁ | Ground Reference for Isolator Side 1. |
| 3 | 3 | V _{IA} | Logic Input A. |
| 4 | 4 | V _{IB} | Logic Input B. |
| 5 | 5 | V _{IC} | Logic Input C. |
| 6 | 6 | V _{ID} | Logic Input D. |
| 7 | Not applicable | DISABLE ₁ | Input Disable 1. This pin disables the isolator inputs. Outputs take on the logic state determined by the fail-safe option shown in the Ordering Guide. |
| 9, 15 | 9, 15 | GND ₂ | Ground Reference for Isolator Side 2. |
| 10 | 7 | NIC | No Internal Connection. Leave this pin floating. |
| Not Applicable | 10 | V _{E2} | Output Enable 2. Active high logic input. When V _{E2} is high or disconnected, the V _{OA} , V _{OB} , V _{OC} , and V _{OD} outputs are enabled. When V _{E2} is low, the V _{OA} , V _{OB} , V _{OC} , and V _{OD} outputs are disabled to the high-Z state. |
| 11 | 11 | V _{OD} | Logic Output D. |
| 12 | 12 | V _{OC} | Logic Output C. |
| 13 | 13 | V _{OB} | Logic Output B. |
| 14 | 14 | V _{OA} | Logic Output A. |
| 16 | 16 | V _{DD2} | Supply Voltage for Isolator Side 2. |

¹ Reference the [AN-1109 Application Note](#) for specific layout guidelines.

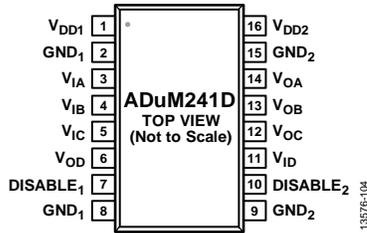

Figure 7. ADuM241D Pin Configuration

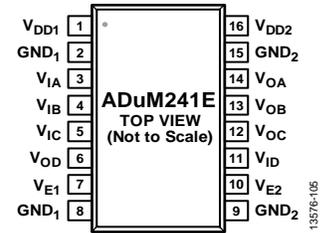

Figure 8. ADuM241E Pin Configuration

Table 22. Pin Function Descriptions

| Pin No. ¹ | | Mnemonic | Description |
|----------------------|----------------|----------------------|---|
| ADuM241D | ADuM241E | | |
| 1 | 1 | V _{DD1} | Supply Voltage for Isolator Side 1. |
| 2, 8 | 2, 8 | GND ₁ | Ground Reference for Isolator Side 1. |
| 3 | 3 | V _{IA} | Logic Input A. |
| 4 | 4 | V _{IB} | Logic Input B. |
| 5 | 5 | V _{IC} | Logic Input C. |
| 6 | 6 | V _{OD} | Logic Output D. |
| 7 | Not applicable | DISABLE ₁ | Input Disable 1. This pin disables the isolator inputs. Outputs take on the logic state determined by the fail-safe option shown in the Ordering Guide. |
| Not Applicable | 7 | V _{E1} | Output Enable 1. Active high logic input. When V _{E1} is high or disconnected, the V _{OD} output is enabled. When V _{E1} is low, the V _{OD} output is disabled to the high-Z state. |
| 9, 15 | 9, 15 | GND ₂ | Ground Reference for Isolator Side 2. |
| 10 | Not applicable | DISABLE ₂ | Input Disable 2. This pin disables the isolator inputs. Outputs take on the logic state determined by the fail-safe option shown in the Ordering Guide. |
| Not Applicable | 10 | V _{E2} | Output Enable 2. Active high logic input. When V _{E2} is high or disconnected, the V _{OA} , V _{OB} , and V _{OC} outputs are enabled. When V _{E2} is low, the V _{OA} , V _{OB} , and V _{OC} outputs are disabled to the high-Z state. |
| 11 | 11 | V _{ID} | Logic Input D. |
| 12 | 12 | V _{OC} | Logic Output C. |
| 13 | 13 | V _{OB} | Logic Output B. |
| 14 | 14 | V _{OA} | Logic Output A. |
| 16 | 16 | V _{DD2} | Supply Voltage for Isolator Side 2. |

¹ Reference the [AN-1109 Application Note](#) for specific layout guidelines.

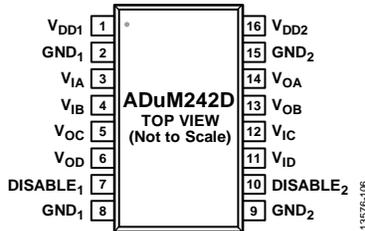

Figure 9. ADuM242D Pin Configuration

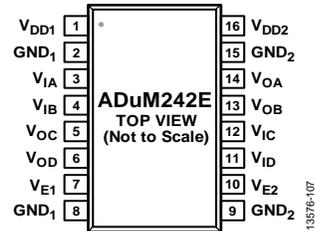

Figure 10. ADuM242E Pin Configuration

Table 23. Pin Function Descriptions

| Pin No. ¹ | | Mnemonic | Description |
|----------------------|----------------|----------------------|---|
| ADuM242D | ADuM242E | | |
| 1 | 1 | V _{DD1} | Supply Voltage for Isolator Side 1. |
| 2, 8 | 2, 8 | GND ₁ | Ground Reference for Isolator Side 1. |
| 3 | 3 | V _{IA} | Logic Input A. |
| 4 | 4 | V _{IB} | Logic Input B. |
| 5 | 5 | V _{OC} | Logic Output C. |
| 6 | 6 | V _{OD} | Logic Output D. |
| 7 | Not applicable | DISABLE ₁ | Input Disable 1. This pin disables the isolator inputs. Outputs take on the logic state determined by the fail-safe option shown in the Ordering Guide. |
| Not Applicable | 7 | V _{E1} | Output Enable 1. Active high logic input. When V _{E1} is high or disconnected, the V _{OC} and V _{OD} outputs are enabled. When V _{E1} is low, the V _{OC} and V _{OD} outputs are disabled to the high-Z state. |
| 9, 15 | 9, 15 | GND ₂ | Ground Reference for Isolator Side 2. |
| 10 | Not applicable | DISABLE ₂ | Input Disable 2. This pin disables the isolator inputs. Outputs take on the logic state determined by the fail-safe option shown in the Ordering Guide. |
| Not Applicable | 10 | V _{E2} | Output Enable 2. Active high logic input. When V _{E2} is high or disconnected, the V _{OA} and V _{OB} outputs are enabled. When V _{E2} is low, the V _{OA} and V _{OB} outputs are disabled to the high-Z state. |
| 11 | 11 | V _{ID} | Logic Input D. |
| 12 | 12 | V _{IC} | Logic Input C. |
| 13 | 13 | V _{OB} | Logic Output B. |
| 14 | 14 | V _{OA} | Logic Output A. |
| 16 | 16 | V _{DD2} | Supply Voltage for Isolator Side 2. |

¹ Reference the [AN-1109 Application Note](#) for specific layout guidelines.

TYPICAL PERFORMANCE CHARACTERISTICS

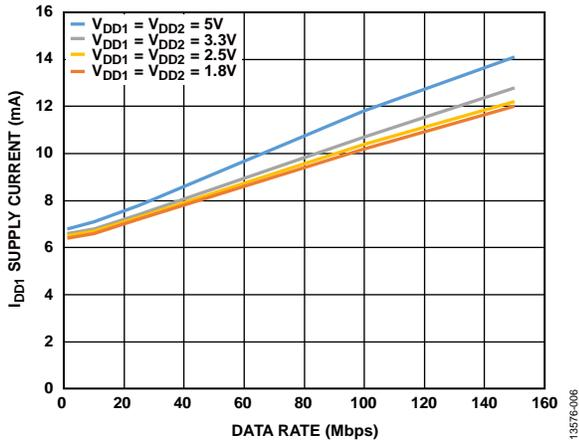

Figure 11. ADuM240D/ADuM240E I_{DD1} Supply Current vs. Data Rate at Various Voltages

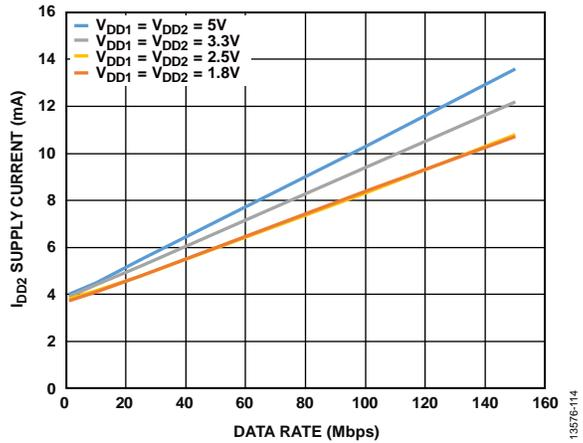

Figure 14. ADuM241D/ADuM241E I_{DD2} Supply Current vs. Data Rate at Various Voltages

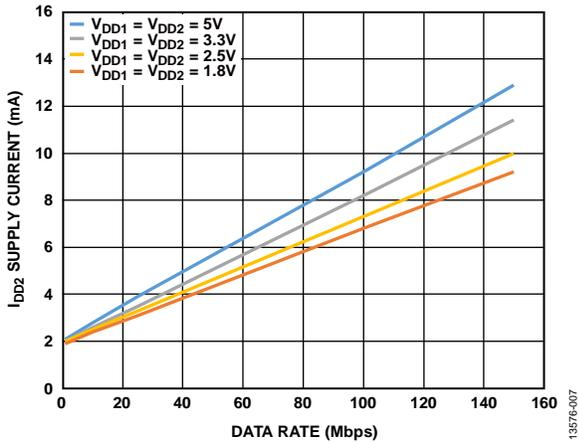

Figure 12. ADuM240D/ADuM240E I_{DD2} Supply Current vs. Data Rate at Various Voltages

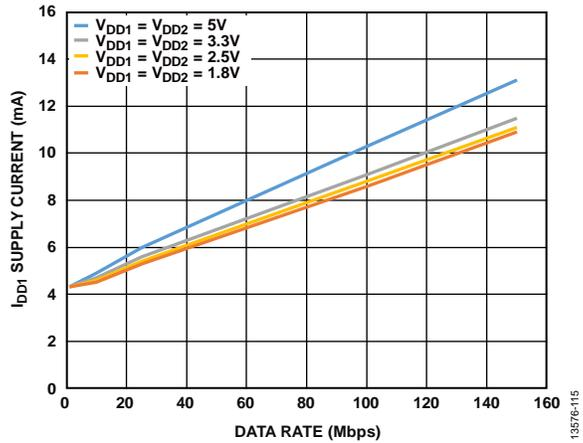

Figure 15. ADuM242D/ADuM242E I_{DD1} Supply Current vs. Data Rate at Various Voltages

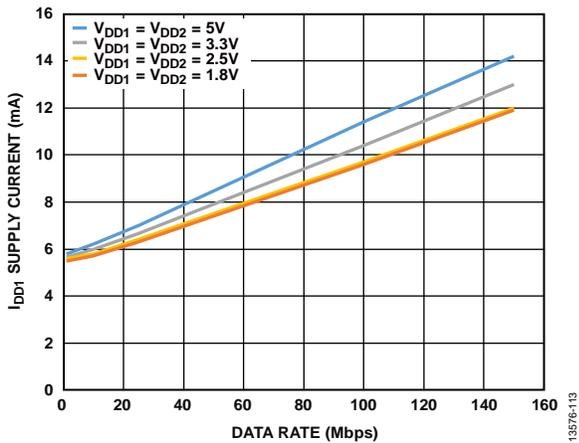

Figure 13. ADuM241D/ADuM241E I_{DD1} Supply Current vs. Data Rate at Various Voltages

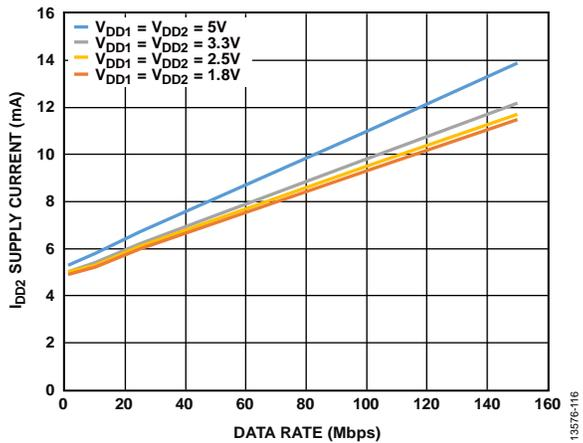

Figure 16. ADuM242D/ADuM242E I_{DD2} Supply Current vs. Data Rate at Various Voltages

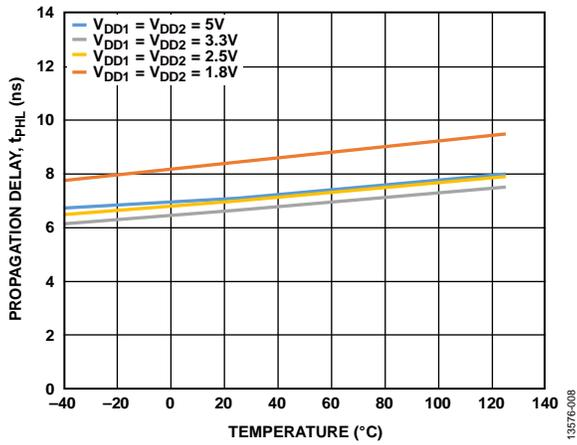

Figure 17. Propagation Delay, t_{PLH} vs. Temperature at Various Voltages

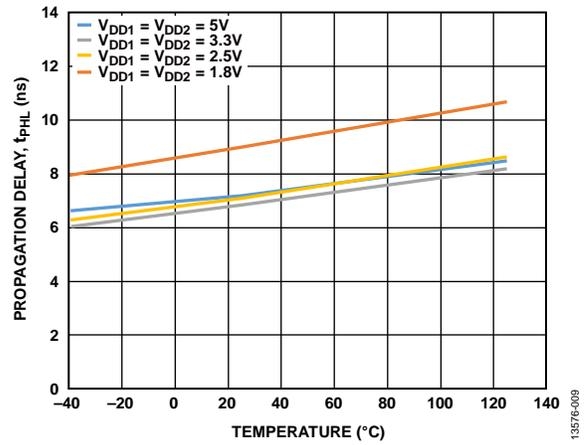

Figure 18. Propagation Delay, t_{PHL} vs. Temperature at Various Voltages

THEORY OF OPERATION

The ADuM240D/ADuM240E/ADuM241D/ADuM241E/ADuM242D/ADuM242E use a high frequency carrier to transmit data across the isolation barrier using *i*Coupler chip scale transformer coils separated by layers of polyimide isolation. Using an on/off keying (OOK) technique and the differential architecture shown in Figure 19 and Figure 20, the ADuM240D/ADuM240E/ADuM241D/ADuM241E/ADuM242D/ADuM242E have very low propagation delay and high speed. Internal regulators and input/output design techniques allow logic and supply voltages over a wide range from 1.7 V to 5.5 V, offering voltage translation of 1.8 V, 2.5 V, 3.3 V, and 5 V logic. The architecture is designed for high common-mode transient immunity and high immunity to electrical noise and magnetic interference. Radiated emissions are minimized with a spread spectrum OOK carrier and other techniques.

Figure 19 illustrates the waveforms for models of the ADuM240D/ADuM240E/ADuM241D/ADuM241E/ADuM242D/ADuM242E that have the condition of the fail-safe output state equal to low, where the carrier waveform is off when the input state is low. If the input side is off or not operating, the low fail-safe output state (ADuM240D0/ADuM240E0/ADuM241D0/ADuM241E0/ADuM242D0/ADuM242E0) sets the output to low. For the ADuM240D/ADuM240E/ADuM241D/ADuM241E/ADuM242D/ADuM242E that have a high fail-safe output state, Figure 20 illustrates the conditions where the carrier waveform is off when the input state is high. When the input side is off or not operating, the high fail-safe output state (ADuM240D1/ADuM240E1/ADuM241D1/ADuM241E1/ADuM242D1/ADuM242E1) sets the output to high. See the Ordering Guide for the model numbers that have the fail-safe output state of low or the fail-safe output state of high.

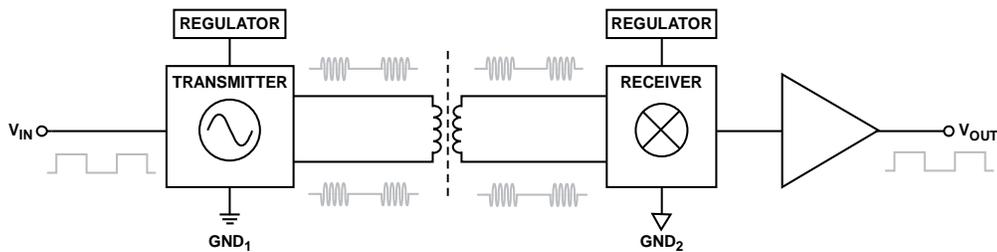

Figure 19. Operational Block Diagram of a Single Channel with a Low Fail-Safe Output State

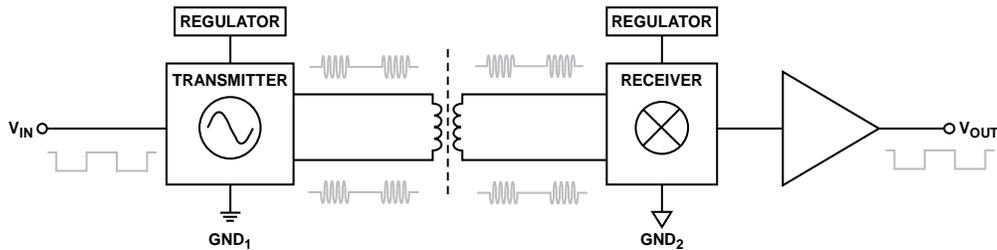

Figure 20. Operational Block Diagram of a Single Channel with a High Fail-Safe Output State

APPLICATIONS INFORMATION

PCB LAYOUT

The ADuM240D/ADuM240E/ADuM241D/ADuM241E/ADuM242D/ADuM242E digital isolators require no external interface circuitry for the logic interfaces. Power supply bypassing is strongly recommended at the input and output supply pins (see Figure 21). Bypass capacitors are most conveniently connected between Pin 1 and Pin 2 for V_{DD1} and between Pin 15 and Pin 16 for V_{DD2} . The recommended bypass capacitor value is between 0.01 μF and 0.1 μF . The total lead length between both ends of the capacitor and the input power supply pin must not exceed 10 mm. Bypassing between Pin 1 and Pin 8 and between Pin 9 and Pin 16 must also be considered, unless the ground pair on each package side is connected close to the package.

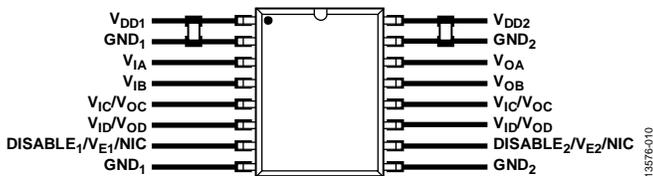

Figure 21. Recommended Printed Circuit Board Layout

In applications involving high common-mode transients, ensure that board coupling across the isolation barrier is minimized. Furthermore, design the board layout such that any coupling that does occur equally affects all pins on a given component side. Failure to ensure this can cause voltage differentials between pins exceeding the Absolute Maximum Ratings of the device, thereby leading to latch-up or permanent damage.

See the AN-1109 Application Note for board layout guidelines.

PROPAGATION DELAY RELATED PARAMETERS

Propagation delay is a parameter that describes the time required for a logic signal to propagate through a component. The propagation delay to a Logic 0 output may differ from the propagation delay to a Logic 1 output.

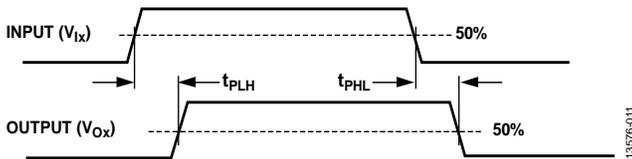

Figure 22. Propagation Delay Parameters

Pulse width distortion is the maximum difference between these two propagation delay values and is an indication of how accurately the timing of the input signal is preserved.

Channel matching is the maximum amount the propagation delay differs between channels within a single ADuM240D/ADuM240E/ADuM241D/ADuM241E/ADuM242D/ADuM242E component.

Propagation delay skew is the maximum amount the propagation delay differs between multiple ADuM240D/ADuM240E/ADuM241D/ADuM241E/ADuM242D/ADuM242E components operating under the same conditions

JITTER MEASUREMENT

Figure 23 shows the eye diagram for the ADuM240D/ADuM240E/ADuM241D/ADuM241E/ADuM242D/ADuM242E. The measurement was taken using an Agilent 81110A pulse pattern generator at 150 Mbps with pseudorandom bit sequences (PRBS) $2(n-1)$, $n=14$, for 5 V supplies. Jitter was measured with the Tektronix Model 5104B oscilloscope, 1 GHz, 10 GSps with the DPOJET jitter and eye diagram analysis tools. The result shows a typical measurement on the ADuM240D/ADuM240E/ADuM241D/ADuM241E/ADuM242D/ADuM242E with 490 ps p-p jitter.

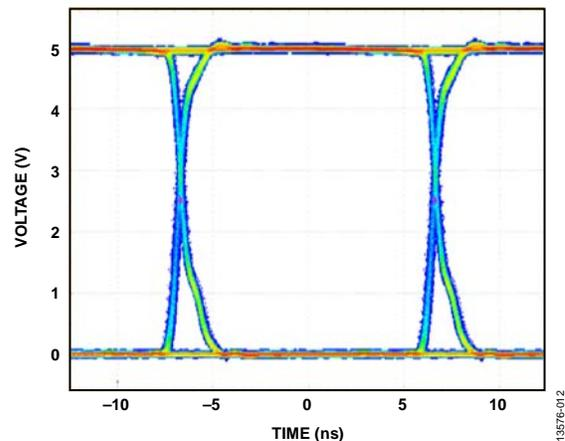

Figure 23. ADuM240D/ADuM240E/ADuM241D/ADuM241E/ADuM242D/ADuM242E Eye Diagram

INSULATION LIFETIME

All insulation structures eventually break down when subjected to voltage stress over a sufficiently long period. The rate of insulation degradation is dependent on the characteristics of the voltage waveform applied across the insulation as well as on the materials and material interfaces.

The two types of insulation degradation of primary interest are breakdown along surfaces exposed to the air and insulation wear out. Surface breakdown is the phenomenon of surface tracking, and the primary determinant of surface creepage requirements in system level standards. Insulation wear out is the phenomenon where charge injection or displacement currents inside the insulation material cause long-term insulation degradation.

Surface Tracking

Surface tracking is addressed in electrical safety standards by setting a minimum surface creepage based on the working voltage, the environmental conditions, and the properties of the insulation material. Safety agencies perform characterization testing on the surface insulation of components that allows the components to be categorized in different material groups. Lower material group ratings are more resistant to surface tracking and, therefore, can provide adequate lifetime with smaller creepage. The minimum creepage for a given working voltage and material group is in each

system level standard and is based on the total rms voltage across the isolation, pollution degree, and material group. The material group and creepage for the [ADuM240D/ADuM240E/ADuM241D/ADuM241E/ADuM242D/ADuM242E](#) isolators are presented in Table 9.

Insulation Wear Out

The lifetime of insulation caused by wear out is determined by its thickness, material properties, and the voltage stress applied. It is important to verify that the product lifetime is adequate at the application working voltage. The working voltage supported by an isolator for wear out may not be the same as the working voltage supported for tracking. The working voltage applicable to tracking is specified in most standards.

Testing and modeling have shown that the primary driver of long-term degradation is displacement current in the polyimide insulation causing incremental damage. The stress on the insulation can be broken down into broad categories, such as dc stress, which causes very little wear out because there is no displacement current, and an ac component time varying voltage stress, which causes wear out.

The ratings in certification documents are usually based on 60 Hz sinusoidal stress because this reflects isolation from line voltage. However, many practical applications have combinations of 60 Hz ac and dc across the barrier as shown in Equation 1. Because only the ac portion of the stress causes wear out, the equation can be rearranged to solve for the ac rms voltage, as is shown in Equation 2. For insulation wear out with the polyimide materials used in these products, the ac rms voltage determines the product lifetime.

$$V_{RMS} = \sqrt{V_{AC\ RMS}^2 + V_{DC}^2} \quad (1)$$

or

$$V_{AC\ RMS} = \sqrt{V_{RMS}^2 - V_{DC}^2} \quad (2)$$

where:

V_{RMS} is the total rms working voltage.

$V_{AC\ RMS}$ is the time varying portion of the working voltage.

V_{DC} is the dc offset of the working voltage.

Calculation and Use of Parameters Example

The following example frequently arises in power conversion applications. Assume that the line voltage on one side of the isolation is 240 V ac rms and a 400 V dc bus voltage is present on the other side of the isolation barrier. The isolator material is polyimide. To establish the critical voltages in determining the creepage, clearance, and lifetime of a device, see Figure 24 and the following equations.

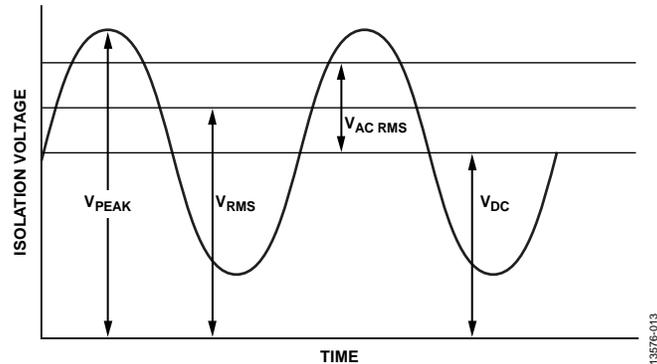

Figure 24. Critical Voltage Example

The working voltage across the barrier from Equation 1 is

$$V_{RMS} = \sqrt{V_{AC\ RMS}^2 + V_{DC}^2}$$

$$V_{RMS} = \sqrt{240^2 + 400^2}$$

$$V_{RMS} = 466\text{ V}$$

This V_{RMS} value is the working voltage used together with the material group and pollution degree when looking up the creepage required by a system standard.

To determine if the lifetime is adequate, obtain the time varying portion of the working voltage. To obtain the ac rms voltage, use Equation 2.

$$V_{AC\ RMS} = \sqrt{V_{RMS}^2 - V_{DC}^2}$$

$$V_{AC\ RMS} = \sqrt{466^2 - 400^2}$$

$$V_{AC\ RMS} = 240\text{ V rms}$$

In this case, the ac rms voltage is simply the line voltage of 240 V rms. This calculation is more relevant when the waveform is not sinusoidal. The value is compared to the limits for working voltage in Table 17 for the expected lifetime, less than a 60 Hz sine wave, and it is well within the limit for a 50-year service life.

Note that the dc working voltage limit in Table 17 is set by the creepage of the package as specified in IEC 60664-1. This value can differ for specific system level standards.

OUTLINE DIMENSIONS

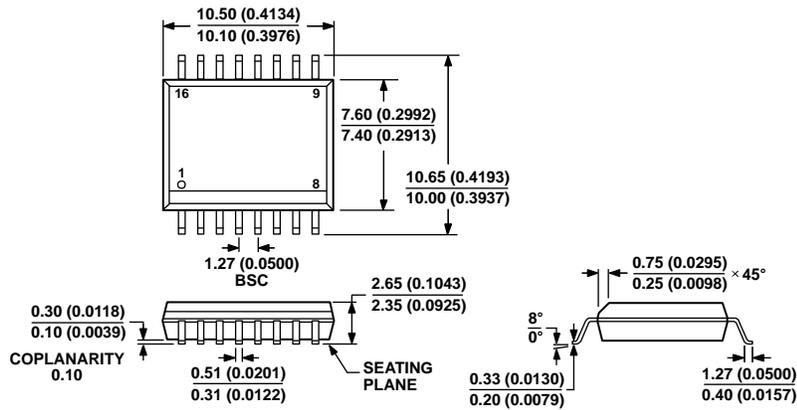

COMPLIANT TO JEDEC STANDARDS MS-013-AA
CONTROLLING DIMENSIONS ARE IN MILLIMETERS; INCH DIMENSIONS (IN PARENTHESES) ARE ROUNDED-OFF MILLIMETER EQUIVALENTS FOR REFERENCE ONLY AND ARE NOT APPROPRIATE FOR USE IN DESIGN.

Figure 25. 16-Lead Standard Small Outline Package [SOIC_W] Wide Body (RW-16)

Dimensions shown in millimeters and (inches)

03-27-2007-9

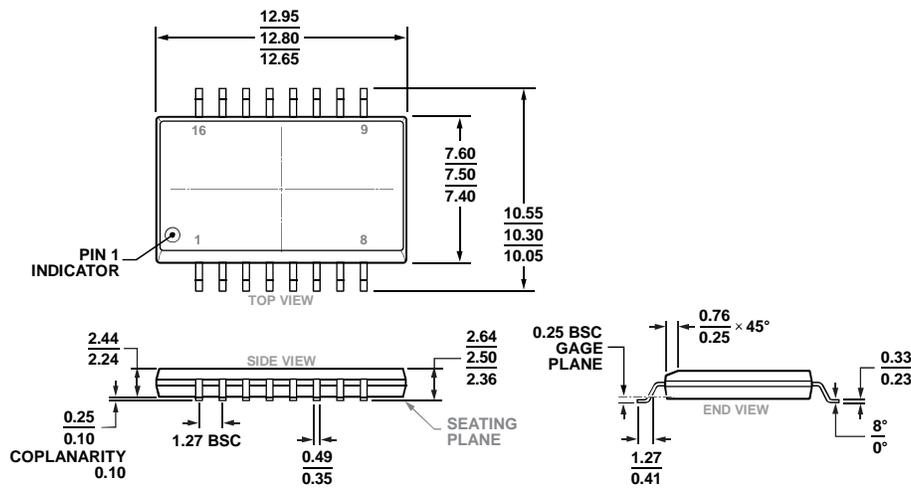

COMPLIANT TO JEDEC STANDARDS MS-013-AC

Figure 26. 16-Lead Standard Small Outline Package, with Increased Creepage [SOIC_IC] Wide Body (RI-16-2)

Dimensions shown in millimeters

12-13-2017-B

ORDERING GUIDE

| Model ^{1,2} | Temperature Range | No. of Inputs, V _{DD1} Side | No. of Inputs, V _{DD2} Side | Withstand Voltage Rating (kV rms) | Fail-Safe Output State | Input Disable | Output Enable | Package Description | Package Option |
|----------------------|-------------------|--------------------------------------|--------------------------------------|-----------------------------------|------------------------|---------------|---------------|---------------------|----------------|
| ADuM240D1BRWZ | -40°C to +125°C | 4 | 0 | 5.0 | High | Yes | No | 16-Lead SOIC_W | RW-16 |
| ADuM240D1BRWZ-RL | -40°C to +125°C | 4 | 0 | 5.0 | High | Yes | No | 16-Lead SOIC_W | RW-16 |
| ADuM240D0BRWZ | -40°C to +125°C | 4 | 0 | 5.0 | Low | Yes | No | 16-Lead SOIC_W | RW-16 |
| ADuM240D0BRWZ-RL | -40°C to +125°C | 4 | 0 | 5.0 | Low | Yes | No | 16-Lead SOIC_W | RW-16 |
| ADuM240E1BRWZ | -40°C to +125°C | 4 | 0 | 5.0 | High | No | Yes | 16-Lead SOIC_W | RW-16 |
| ADuM240E1BRWZ-RL | -40°C to +125°C | 4 | 0 | 5.0 | High | No | Yes | 16-Lead SOIC_W | RW-16 |
| ADuM240E0BRWZ | -40°C to +125°C | 4 | 0 | 5.0 | Low | No | Yes | 16-Lead SOIC_W | RW-16 |
| ADuM240E0BRWZ-RL | -40°C to +125°C | 4 | 0 | 5.0 | Low | No | Yes | 16-Lead SOIC_W | RW-16 |

| Model ^{1,2} | Temperature Range | No. of Inputs, V _{DD1} Side | No. of Inputs, V _{DD2} Side | Withstand Voltage Rating (kV rms) | Fail-Safe Output State | Input Disable | Output Enable | Package Description | Package Option |
|----------------------|-------------------|--------------------------------------|--------------------------------------|-----------------------------------|------------------------|---------------|---------------|---------------------|----------------|
| ADuM240E0WBRWZ | -40°C to +125°C | 4 | 0 | 5.0 | Low | No | Yes | 16-Lead SOIC_W | RW-16 |
| ADuM240E0WBRWZ-RL | -40°C to +125°C | 4 | 0 | 5.0 | Low | No | Yes | 16-Lead SOIC_W | RW-16 |
| ADuM240D1BRIZ | -40°C to +125°C | 4 | 0 | 5.0 | High | Yes | No | 16-Lead SOIC_IC | RI-16-2 |
| ADuM240D1BRIZ-RL | -40°C to +125°C | 4 | 0 | 5.0 | High | Yes | No | 16-Lead SOIC_IC | RI-16-2 |
| ADuM240D0BRIZ | -40°C to +125°C | 4 | 0 | 5.0 | Low | Yes | No | 16-Lead SOIC_IC | RI-16-2 |
| ADuM240D0BRIZ-RL | -40°C to +125°C | 4 | 0 | 5.0 | Low | Yes | No | 16-Lead SOIC_IC | RI-16-2 |
| ADuM240E1BRIZ | -40°C to +125°C | 4 | 0 | 5.0 | High | No | Yes | 16-Lead SOIC_IC | RI-16-2 |
| ADuM240E1BRIZ-RL | -40°C to +125°C | 4 | 0 | 5.0 | High | No | Yes | 16-Lead SOIC_IC | RI-16-2 |
| ADuM240E0BRIZ | -40°C to +125°C | 4 | 0 | 5.0 | Low | No | Yes | 16-Lead SOIC_IC | RI-16-2 |
| ADuM240E0BRIZ-RL | -40°C to +125°C | 4 | 0 | 5.0 | Low | No | Yes | 16-Lead SOIC_IC | RI-16-2 |
| ADuM241D1BRWZ | -40°C to +125°C | 3 | 1 | 5.0 | High | Yes | No | 16-Lead SOIC_W | RW-16 |
| ADuM241D1BRWZ-RL | -40°C to +125°C | 3 | 1 | 5.0 | High | Yes | No | 16-Lead SOIC_W | RW-16 |
| ADuM241D0BRWZ | -40°C to +125°C | 3 | 1 | 5.0 | Low | Yes | No | 16-Lead SOIC_W | RW-16 |
| ADuM241D0BRWZ-RL | -40°C to +125°C | 3 | 1 | 5.0 | Low | Yes | No | 16-Lead SOIC_W | RW-16 |
| ADuM241E1BRWZ | -40°C to +125°C | 3 | 1 | 5.0 | High | No | Yes | 16-Lead SOIC_W | RW-16 |
| ADuM241E1BRWZ-RL | -40°C to +125°C | 3 | 1 | 5.0 | High | No | Yes | 16-Lead SOIC_W | RW-16 |
| ADuM241E1WBRWZ | -40°C to +125°C | 3 | 1 | 5.0 | High | No | Yes | 16-Lead SOIC_W | RW-16 |
| ADuM241E1WBRWZ-RL | -40°C to +125°C | 3 | 1 | 5.0 | High | No | Yes | 16-Lead SOIC_W | RW-16 |
| ADuM241E0BRWZ | -40°C to +125°C | 3 | 1 | 5.0 | Low | No | Yes | 16-Lead SOIC_W | RW-16 |
| ADuM241E0BRWZ-RL | -40°C to +125°C | 3 | 1 | 5.0 | Low | No | Yes | 16-Lead SOIC_W | RW-16 |
| ADuM241D1BRIZ | -40°C to +125°C | 3 | 1 | 5.0 | High | Yes | No | 16-Lead SOIC_IC | RI-16-2 |
| ADuM241D1BRIZ-RL | -40°C to +125°C | 3 | 1 | 5.0 | High | Yes | No | 16-Lead SOIC_IC | RI-16-2 |
| ADuM241D0BRIZ | -40°C to +125°C | 3 | 1 | 5.0 | Low | Yes | No | 16-Lead SOIC_IC | RI-16-2 |
| ADuM241D0BRIZ-RL | -40°C to +125°C | 3 | 1 | 5.0 | Low | Yes | No | 16-Lead SOIC_IC | RI-16-2 |
| ADuM241E1BRIZ | -40°C to +125°C | 3 | 1 | 5.0 | High | No | Yes | 16-Lead SOIC_IC | RI-16-2 |
| ADuM241E1BRIZ-RL | -40°C to +125°C | 3 | 1 | 5.0 | High | No | Yes | 16-Lead SOIC_IC | RI-16-2 |
| ADuM241E0BRIZ | -40°C to +125°C | 3 | 1 | 5.0 | Low | No | Yes | 16-Lead SOIC_IC | RI-16-2 |
| ADuM241E0BRIZ-RL | -40°C to +125°C | 3 | 1 | 5.0 | Low | No | Yes | 16-Lead SOIC_IC | RI-16-2 |
| ADuM242D1BRWZ | -40°C to +125°C | 2 | 2 | 5.0 | High | Yes | No | 16-Lead SOIC_W | RW-16 |
| ADuM242D1BRWZ-RL | -40°C to +125°C | 2 | 2 | 5.0 | High | Yes | No | 16-Lead SOIC_W | RW-16 |
| ADuM242D0BRWZ | -40°C to +125°C | 2 | 2 | 5.0 | Low | Yes | No | 16-Lead SOIC_W | RW-16 |
| ADuM242D0BRWZ-RL | -40°C to +125°C | 2 | 2 | 5.0 | Low | Yes | No | 16-Lead SOIC_W | RW-16 |
| ADuM242E1BRWZ | -40°C to +125°C | 2 | 2 | 5.0 | High | No | Yes | 16-Lead SOIC_W | RW-16 |
| ADuM242E1BRWZ-RL | -40°C to +125°C | 2 | 2 | 5.0 | High | No | Yes | 16-Lead SOIC_W | RW-16 |
| ADuM242E0BRWZ | -40°C to +125°C | 2 | 2 | 5.0 | Low | No | Yes | 16-Lead SOIC_W | RW-16 |
| ADuM242E0BRWZ-RL | -40°C to +125°C | 2 | 2 | 5.0 | Low | No | Yes | 16-Lead SOIC_W | RW-16 |
| ADuM242E0WBRWZ | -40°C to +125°C | 2 | 2 | 5.0 | Low | No | Yes | 16-Lead SOIC_W | RW-16 |
| ADuM242E0WBRWZ-RL | -40°C to +125°C | 2 | 2 | 5.0 | Low | No | Yes | 16-Lead SOIC_W | RW-16 |
| ADuM242D1BRIZ | -40°C to +125°C | 2 | 2 | 5.0 | High | Yes | No | 16-Lead SOIC_IC | RI-16-2 |
| ADuM242D1BRIZ-RL | -40°C to +125°C | 2 | 2 | 5.0 | High | Yes | No | 16-Lead SOIC_IC | RI-16-2 |
| ADuM242D0BRIZ | -40°C to +125°C | 2 | 2 | 5.0 | Low | Yes | No | 16-Lead SOIC_IC | RI-16-2 |
| ADuM242D0BRIZ-RL | -40°C to +125°C | 2 | 2 | 5.0 | Low | Yes | No | 16-Lead SOIC_IC | RI-16-2 |
| ADuM242E1BRIZ | -40°C to +125°C | 2 | 2 | 5.0 | High | No | Yes | 16-Lead SOIC_IC | RI-16-2 |
| ADuM242E1BRIZ-RL | -40°C to +125°C | 2 | 2 | 5.0 | High | No | Yes | 16-Lead SOIC_IC | RI-16-2 |
| ADuM242E0BRIZ | -40°C to +125°C | 2 | 2 | 5.0 | Low | No | Yes | 16-Lead SOIC_IC | RI-16-2 |
| ADuM242E0BRIZ-RL | -40°C to +125°C | 2 | 2 | 5.0 | Low | No | Yes | 16-Lead SOIC_IC | RI-16-2 |

¹ Z = RoHS Compliant Part.² The ADuM240E0WBRWZ, ADuM240E0WBRWZ-RL, ADuM241E1WBRWZ, ADuM241E1WBRWZ-RL, ADuM242E0WBRWZ and ADuM242E0WBRWZ-RL are qualified for automotive applications.

AUTOMOTIVE PRODUCTS

The [ADuM240E0W](#), [ADuM241E1W](#), and [ADuM242E0W](#) models are available with controlled manufacturing to support the quality and reliability requirements of automotive applications. Note that these automotive models may have specifications that differ from the commercial models; therefore, designers should review the Specifications section of this data sheet carefully. Only the automotive grade products shown are available for use in automotive applications. Contact your local Analog Devices account representative for specific product ordering information and to obtain the specific Automotive Reliability reports for these models.



Компания «ЭлектроПласт» предлагает заключение долгосрочных отношений при поставках импортных электронных компонентов на взаимовыгодных условиях!

Наши преимущества:

- Оперативные поставки широкого спектра электронных компонентов отечественного и импортного производства напрямую от производителей и с крупнейших мировых складов;
- Поставка более 17-ти миллионов наименований электронных компонентов;
- Поставка сложных, дефицитных, либо снятых с производства позиций;
- Оперативные сроки поставки под заказ (от 5 рабочих дней);
- Экспресс доставка в любую точку России;
- Техническая поддержка проекта, помощь в подборе аналогов, поставка прототипов;
- Система менеджмента качества сертифицирована по Международному стандарту ISO 9001;
- Лицензия ФСБ на осуществление работ с использованием сведений, составляющих государственную тайну;
- Поставка специализированных компонентов (Xilinx, Altera, Analog Devices, Intersil, Interpoint, Microsemi, Aeroflex, Peregrine, Syfer, Eurofarad, Texas Instrument, Miteq, Cobham, E2V, MA-COM, Hittite, Mini-Circuits, General Dynamics и др.);

Помимо этого, одним из направлений компании «ЭлектроПласт» является направление «Источники питания». Мы предлагаем Вам помощь Конструкторского отдела:

- Подбор оптимального решения, техническое обоснование при выборе компонента;
- Подбор аналогов;
- Консультации по применению компонента;
- Поставка образцов и прототипов;
- Техническая поддержка проекта;
- Защита от снятия компонента с производства.



Как с нами связаться

Телефон: 8 (812) 309 58 32 (многоканальный)

Факс: 8 (812) 320-02-42

Электронная почта: org@eplast1.ru

Адрес: 198099, г. Санкт-Петербург, ул. Калинина, дом 2, корпус 4, литера А.