

## General Purpose

### Power Relay

### SZR-MY Series

#### FEATURES

- Small package design
- DPDT has a fine silver contact with 5 A capability
- 4PDT has a gold-plated silver contact with 3 A capability
- High dielectric strength (1,800 Vac)
- High reliability and long life
- Ultra-high sensitivity with quick response time (20 ms max.)
- Options include LED indicator, diode protection, and LED indicator/diode protection
- UL listed, CE certified, CSA certified

#### TYPICAL APPLICATIONS

- Control panels
- Elevator panels
- Machine tools
- Test equipment

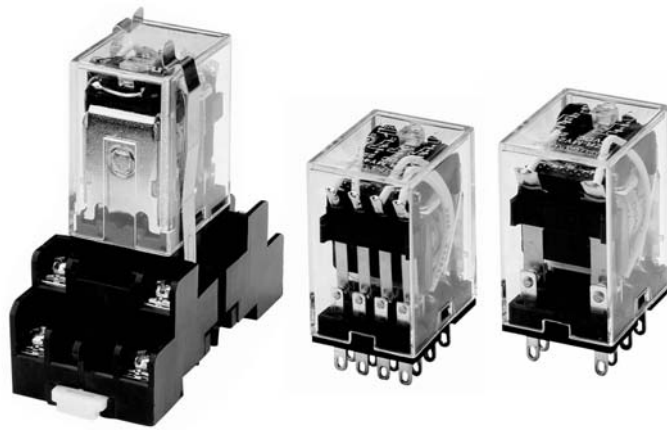

SZR-MY Series general-purpose power relays are designed for a wide range of applications including power as well as logic control for factory machines and control panels.

SZR-MY Series relays have a small package design for multiple application needs. Relays are available in two configurations: DPDT with a 5A load and 4PDT with a 3 A load.

One standard and three options are available: LED indicator, internal surge protection diode, and LED indicator/diode protection. Honeywell's global sales and distribution channels ensure a rapid response and excellent customer service.

#### **⚠ WARNING**

##### **PERSONAL INJURY**

DO NOT USE these products as safety or emergency stop devices or in any other application where failure of the product could result in personal injury.

**Failure to comply with these instructions could result in death or serious injury.**

#### **⚠ WARNING**

##### **MISUSE OF DOCUMENTATION**

- The information presented in this product sheet is for reference only. Do not use this document as a product installation guide.
- Complete installation, operation, and maintenance information is provided in the instructions supplied with each product.

**Failure to comply with these instructions could result in death or serious injury.**

# General Purpose





## Power Relays

*SZR-MY Series*

### RELAY MODEL SELECTION GUIDE

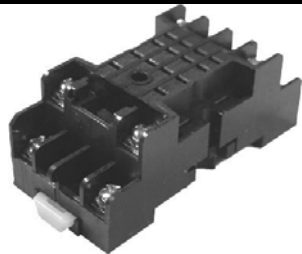
Type	Terminal	Contact	Catalog Listing
Standard	Plug-in/Solder	DPDT	<b>SZR-MY2-1</b>
		4PDT	<b>SZR-MY4-1</b>
	PCB	DPDT	<b>SZR-MY2-1P</b>
		4PDT	<b>SZR-MY4-1P</b>
LED Indicator	Plug-in/Solder	DPDT	<b>SZR-MY2-N1</b>
		4PDT	<b>SZR-MY4-N1</b>
DIODE surge suppression		DPDT	<b>SZR-MY2-D1</b>
		4PDT	<b>SZR-MY4-D1</b>
LED indicator + surge suppression		DPDT	<b>SZR-MY2-X1</b>
		4PDT	<b>SZR-MY4-X1</b>

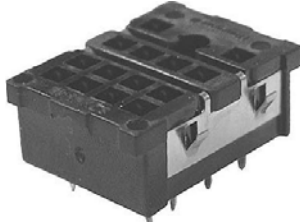
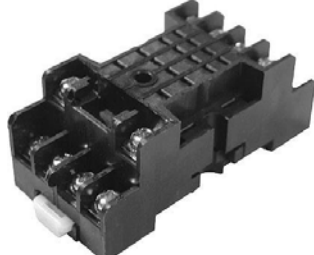
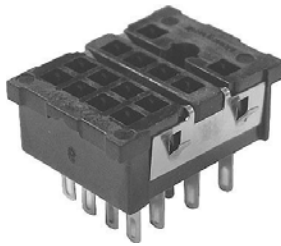
### SOCKETS – REQUIRED ACCESSORIES

	Din-rail Mounting	Solder Terminal	PCB Terminal
Relay Contact			
<b>DPDT</b> For use with SZR-MY2-1, -N1, - D1, -X1	 <b>SZX-SMF-08N</b>	 <b>SZX-SMB-08</b>	 <b>SZX-SMB-08P</b>
<b>4PDT</b> For use with SZR-MY4-1, -N1, - D1, -X1	 <b>SZX-SMF-14N</b>	 <b>SZX-SMB-14</b>	 <b>SZX-SMB-14P</b>

# General Purpose

## Power Relays

*SZR-MY Series*

### CONTACT RATINGS

Type	DPDT		4PDT	
Load	Resistive Load (p.f. = 1)	Inductive load (p.f. = 0.4, L/R = 7 ms)	Resistive Load (p.f. = 1)	Inductive load (p.f. = 0.4, L/R = 7 ms)
<b>Ratings</b>				
<b>Rated load</b>	220 Vac, 5A 24 Vdc, 5A	220 Vac, 2A 24 Vdc, 2A	220 Vac, 3A 24 Vdc, 3A	220 Vac, 0.8 A 24 Vdc, 1.5 A
<b>Carry current</b>	5A		3A	
<b>Max. operating voltage</b>	250 Vac, 125 Vdc		250 Vac, 125 Vdc	
<b>Max. operating current</b>	5 A		3 A	
<b>Max. switching capacity</b>	1,100 VA, 120 W	440 VA, 48 W	660 VA, 72 W	176 VA, 16 W
<b>Min. permissible load</b>	1 mA, 5 Vdc		1 mA, 1 Vdc	

### COIL RATINGS

	Rated Voltage (V)	Rated Current (mA)		Coil resistance (Ω)	Coil Inductance (H)		Pick-up Voltage (V)	Dropout Voltage (V)	Maximum Voltage (V)	Power Consumption (W)			
		50 Hz	60 Hz		Armature OFF	Armature ON							
AC	6	214.1	183	12.2	0.04	0.08	Max. 75 %	Min. 30%	110%	Approx. 1.0 W to 1.2 W (60 Hz)			
	12	106.5	91	46	0.17	0.33							
	24	53.8	46	180	0.69	1.3							
	50	25.7	22	788	3.22	5.66				Max. 75%	Min. 10%	110%	Approx. 0.9 W to 1.1 W (60 Hz)
	100/110	11.7/12.9	10/11	3,750	14.54	24.6							
	110/120	9.9/10.8	8.4/9.2	4,430	19.2	32.1							
	200/220	6.2/6.8	5.3/5.8	12,950	54.75	94.07							
220/240	4.8/5.3	4.2/4.6	18,790	83.5	136.4								
DC	6	150		40	0.17	0.33	Max. 75%	Min. 10%	110%	Approx. 0.9 W			
	12	75		160	0.73	1.37							
	24	36.9		650	3.2	5.72							
	48	18.5		2,600	10.6	21.0							
	100/110	9.1/10		11,000	45.6	86.2							

Note 1: The rated current and coil resistance are measured at a coil temperature of 23 °C [73.4 °F] with tolerances of +15%, -20% for AC rated current and ± 15% for DC coil resistance.

Note 2: The rated current of N1 and X1 types is 4 mA higher than the value in the table above.

# General Purpose

## Power Relays

SZR-MY Series

### SPECIFICATIONS

Contact material		Silver
Contact resistance		Max. 50 MOhm
Operate time		Max. 20 ms
Release time		Max. 20 ms
Operating frequency	Mechanical	18,000 operations per hour
	Electrical	1,800 operations per hour
Insulation resistance		Min. 100 Mw at 500 Vdc
Dielectric withstand voltage		1,800 Vac 50 Hz/60 Hz for one minute between non-continuous current carrying terminals and between coil thermals and contact terminals
Vibration resistance	Mechanical durability	10 Hz to 55 Hz at double amplitude of 1.0 mm
	Malfunction durability	10 Hz to 55 Hz at double amplitude of 1.0 mm
Shock resistance	Mechanical durability	1,000 m/s <sup>2</sup> (approx. 100 g)
	Malfunction durability	200 m/s <sup>2</sup> (approx. 20 g)
Service life	Mechanical	AC: Min. 50 million operations (at operating frequency of 18,000 operations/hour) DC: Min. 100 million operations (at operating frequency of 18,000 operations/hour)
	Electrical	DPDT: Min. 500,000 operations (at operating frequency of 1,800 operations/hour) 4PDT: Min. 200,000 operations (at operating frequency of 1,800 operations/hour)
Weight		Approximately 35 g

Note 1: The data shown above are of initial value

### CHARACTERISTIC DATA

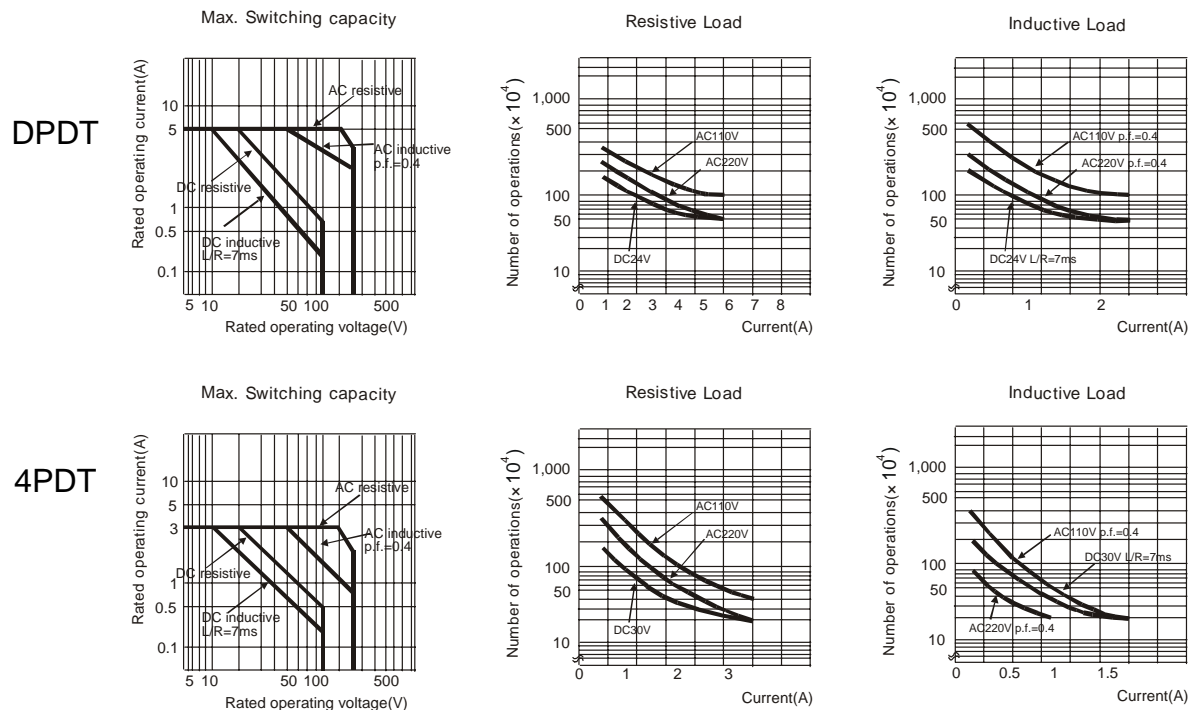

# General Purpose

## Power Relays

*SZR-MY Series*

### HOLDING CLIPS

- Holding clips are included with the sockets
- Holding clips for the SMF-08N and SMF-14N cannot be removed once inserted
- Holding clips for all SMB sockets are wire for easy removal
- Holding clips are to be inserted into the slots provided on the socket

### DIMENSIONS (For reference only – mm/in)

**Figure 1. Dimensions**

For SZX-SMF-08N and SZX-SMF-14N sockets

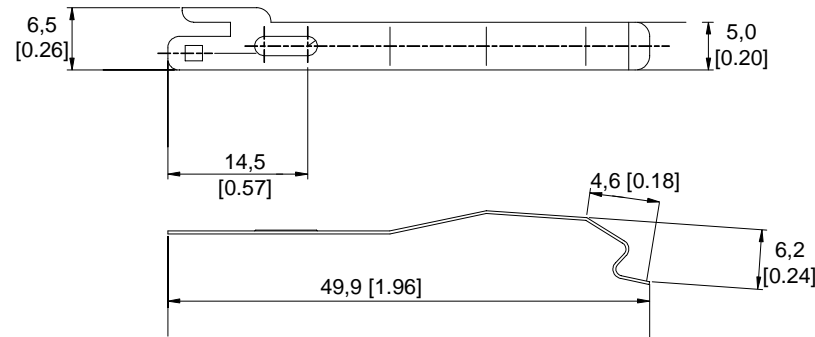

**Figure 2. Dimensions**

For all SZX-SMB sockets

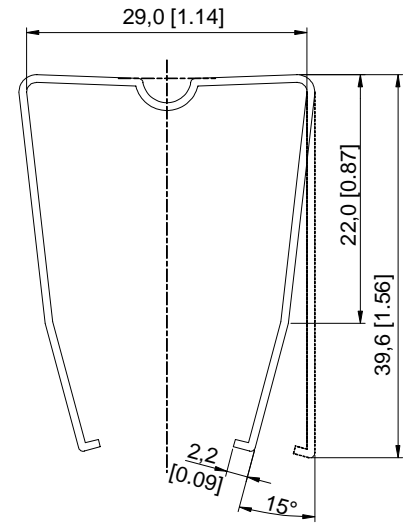

# General Purpose

## Power Relays

*SZR-MY Series*

### CATALOG LISTING MATRIX



# General Purpose

## Power Relays

*SZR-MY Series*

**FIGURE 3. DIMENSION, CIRCUIT DIAGRAM, TERMINAL ARRANGEMENT, AND MOUNTING HOLE FOR SZR-MY2-1, SZR-MY2-N1, SZR-MY2-D1, and SZR-MY2-X1**



**FIGURE 4. DIMENSION, CIRCUIT DIAGRAM, TERMINAL ARRANGEMENT, AND MOUNTING HOLE FOR SZR-MY2-1P and SZR-MY4-1P**



The circuit diagram is the same with standard type of SZR-MY2-1 or the SZR-MY4-1

# General Purpose

## Power Relays

## SZR-MY Series

**FIGURE 5. DIMENSION, CIRCUIT DIAGRAM, TERMINAL ARRANGEMENT, AND MOUNTING HOLE FOR SZR-MY4-1, SZR-MY4-N1, SZR-MY4-D1, and SZR-MY4-X1**

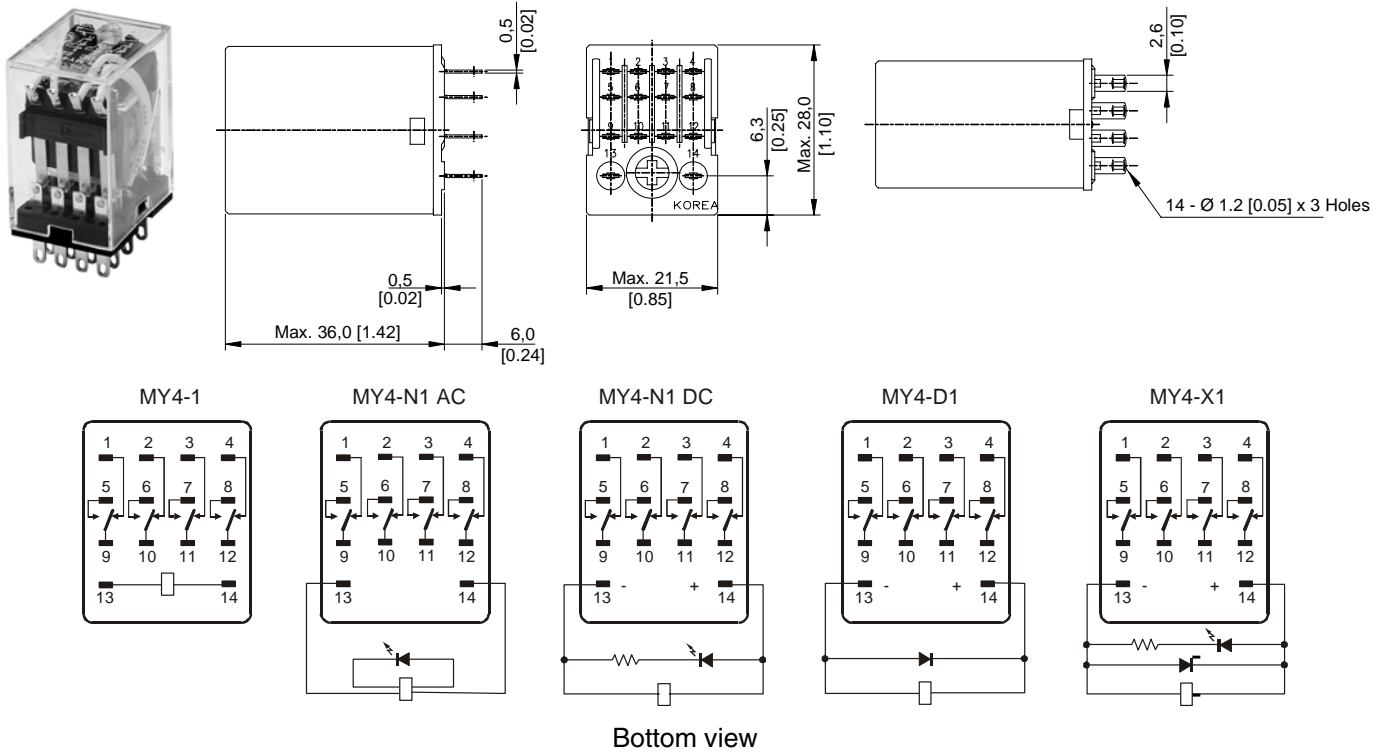

**FIGURE 6. CIRCUIT DRAWING FOR SZR-MY2- and SZR-MY4-**





# General Purpose Power Relays

## SZR-MY Series

### SOCKETS

FIGURE 7. SZX-SMF-08N

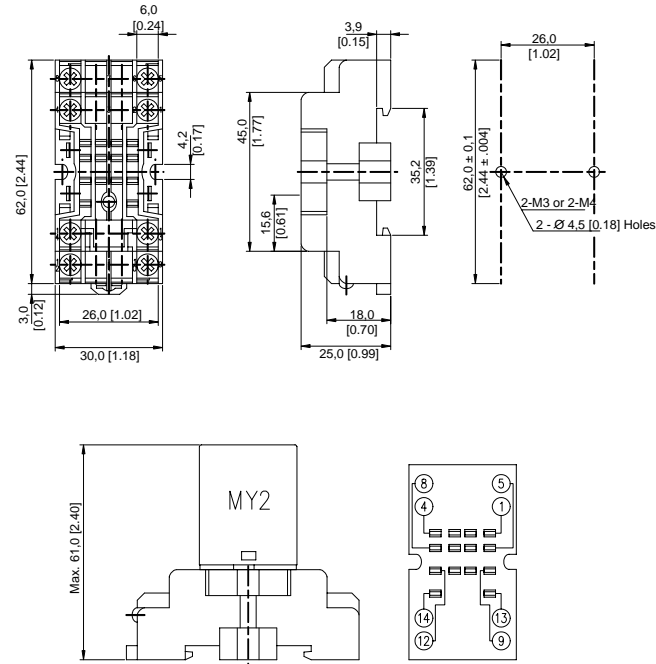

FIGURE 8. SZX-SMF-14N

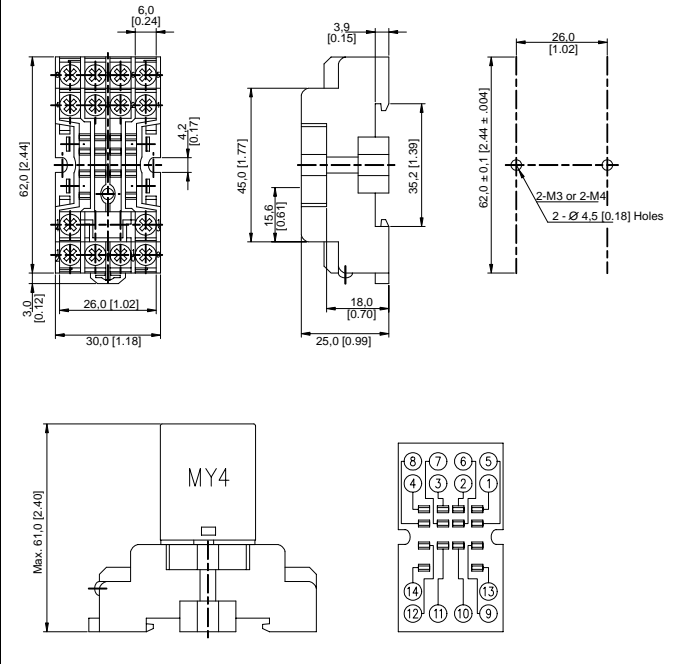

FIGURE 9. SZX-SMB-08

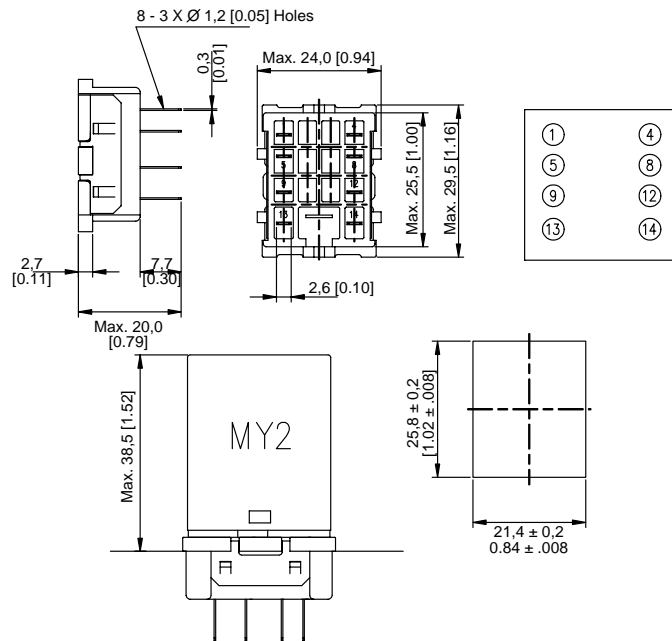
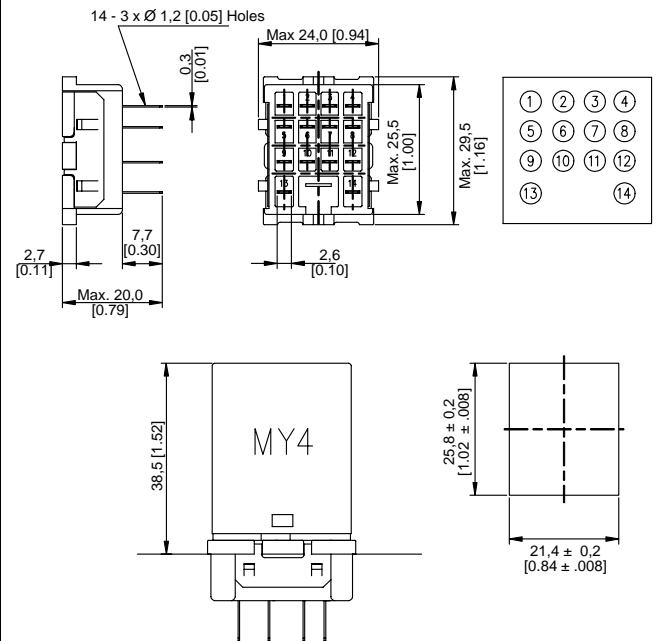

FIGURE 10. SZX-SMB-14



# General Purpose Power Relays

*SZR-MY Series*

**FIGURE 11. SZX-SMB-08P**

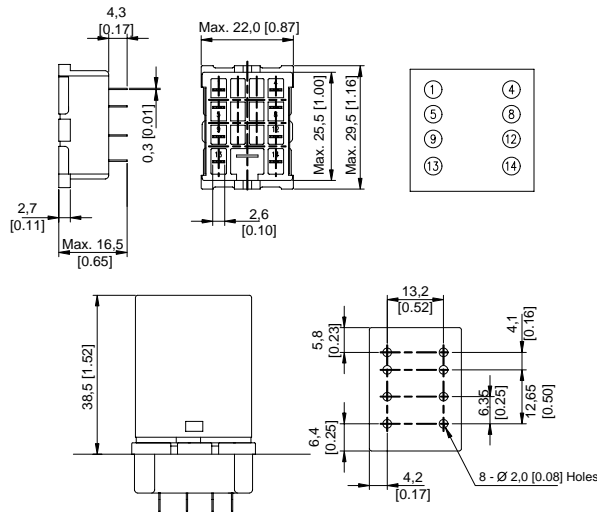

**FIGURE 12. SZX-SMB-14P**

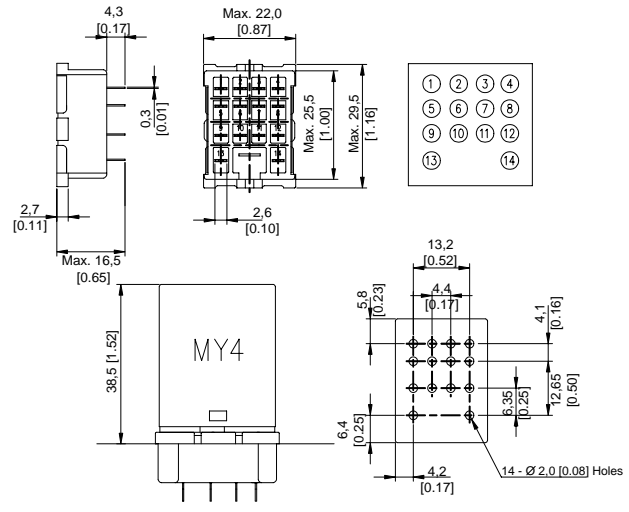

## WARRANTY/REMEDY

Honeywell warrants goods of its manufacture as being free of defective materials and faulty workmanship. Contact your local sales office for warranty information. If warranted goods are returned to Honeywell during the period of coverage, Honeywell will repair or replace without charge those items it finds defective. **The foregoing is Buyer's sole remedy and is in lieu of all other warranties, expressed or implied, including those of merchantability and fitness for a particular purpose.**

Specifications may change without notice. The information we supply is believed to be accurate and reliable as of this printing. However, we assume no responsibility for its use.

While we provide application assistance personally, through our literature and the Honeywell web site, it is up to the customer to determine the suitability of the product in the application.

For application assistance, current specifications, or name of the nearest Authorized Distributor, contact a nearby sales office. Or call:

1-800-537-6945 USA/Canada

1-815-235-6847 International

## FAX

1-815-235-6545 USA

## INTERNET

[www.honeywell.com/sensing](http://www.honeywell.com/sensing)

[info.sc@honeywell.com](mailto:info.sc@honeywell.com)

# Honeywell

Sensing and Control  
[www.honeywell.com/sensing](http://www.honeywell.com/sensing)

Honeywell  
11 West Spring Street  
Freeport, Illinois 61032



Компания «ЭлектроПласт» предлагает заключение долгосрочных отношений при поставках импортных электронных компонентов на взаимовыгодных условиях!

Наши преимущества:

- Оперативные поставки широкого спектра электронных компонентов отечественного и импортного производства напрямую от производителей и с крупнейших мировых складов;
- Поставка более 17-ти миллионов наименований электронных компонентов;
- Поставка сложных, дефицитных, либо снятых с производства позиций;
- Оперативные сроки поставки под заказ (от 5 рабочих дней);
- Экспресс доставка в любую точку России;
- Техническая поддержка проекта, помощь в подборе аналогов, поставка прототипов;
- Система менеджмента качества сертифицирована по Международному стандарту ISO 9001;
- Лицензия ФСБ на осуществление работ с использованием сведений, составляющих государственную тайну;
- Поставка специализированных компонентов (Xilinx, Altera, Analog Devices, Intersil, Interpoint, Microsemi, Aeroflex, Peregrine, Syfer, Eurofarad, Texas Instrument, Miteq, Cobham, E2V, MA-COM, Hittite, Mini-Circuits, General Dynamics и др.);

Помимо этого, одним из направлений компании «ЭлектроПласт» является направление «Источники питания». Мы предлагаем Вам помощь Конструкторского отдела:

- Подбор оптимального решения, техническое обоснование при выборе компонента;
- Подбор аналогов;
- Консультации по применению компонента;
- Поставка образцов и прототипов;
- Техническая поддержка проекта;
- Защита от снятия компонента с производства.



#### Как с нами связаться

**Телефон:** 8 (812) 309 58 32 (многоканальный)

**Факс:** 8 (812) 320-02-42

**Электронная почта:** [org@eplast1.ru](mailto:org@eplast1.ru)

**Адрес:** 198099, г. Санкт-Петербург, ул. Калинина, дом 2, корпус 4, литера А.